

Optogalvanic spectrometry

Vítězslav Otruba

Fundamentals of the method

- The optogalvanic effect utilizes a combination of atom excitation by resonance radiation and collision ionization by plasma (flame) particles to selectively ionize the determined elements. Ionization is measured using the generated ions and thus indirectly the absorption of radiation.
- The first experimental observation was made by Penning (r.1928) during irradiation of the neon discharge with another neon lamp.

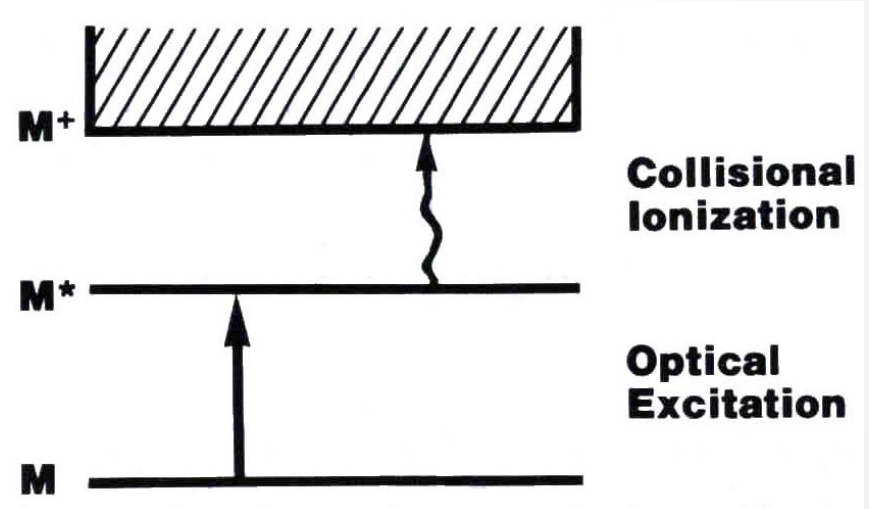

Multiphoton Ionization

- Ionization in MPI is achieved by intense non-selective radiation of very high intensity. Absorption of a series of photons that excite an atom (molecule) into virtual energy states leads to ionization.

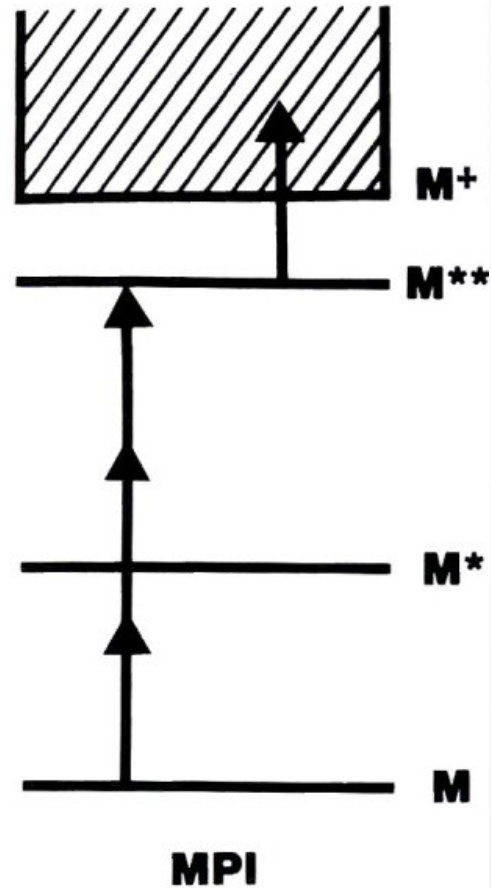

Resonance Ionization Spectroscopy

- RIS uses stepped excitation by resonant radiation followed by ionization. Usually requires two to three tunable lasers.
- The method is highly selective (the resulting selectivity is the product of the selectivity of excitation to individual stages).
- Achieved selectivity of 10^{22} (Cs in Ar), isotopic ratios up to $10^{13} - 10^{18}$ (1 pg in 1t, 1 ag ^{14}C)

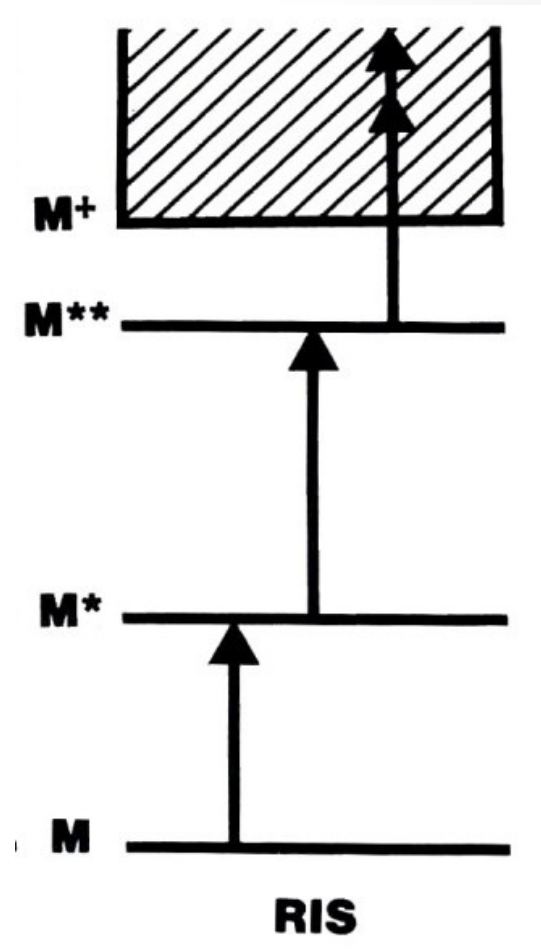

Optogalvanic Effect

- It uses a combination of resonant laser radiation with collision excitation with particles with high kinetic energy:
 - Kinetic energy of particles at high temperature (thermal movement in flame, plasma)
 - Kinetic energy of charged particles accelerated by electric field (discharges, especially under reduced pressure)
- It is a certain variant of atomic fluorescence, where there is a high probability of deexcitation by collisions
- Does not require optical detection equipment
- It detects all ions as opposed to the tiny number of photons detected during fluorescence.

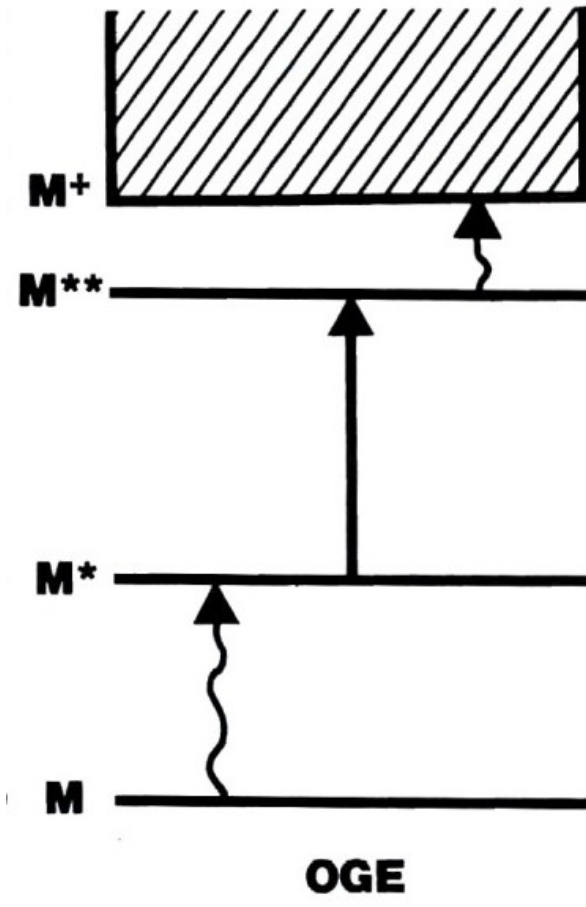

Applications

- Laser keying measurement
- Calibration of wavelengths (e.g. tunable lasers)
- Spectroscopy of states with long life
- Doppler-free spectroscopy
- Spectroscopy of radicals
- Trace analysis
 - in flame
 - in electrothermal atomizer
 - in hollow cathode

Laser-Enhanced Ionization Spectrometry In Flames

High voltage on electrodes - 1000 V, burner isolated from apparatus, connected to the preamplifier input. An analytical signal is taken from the torch (anode).

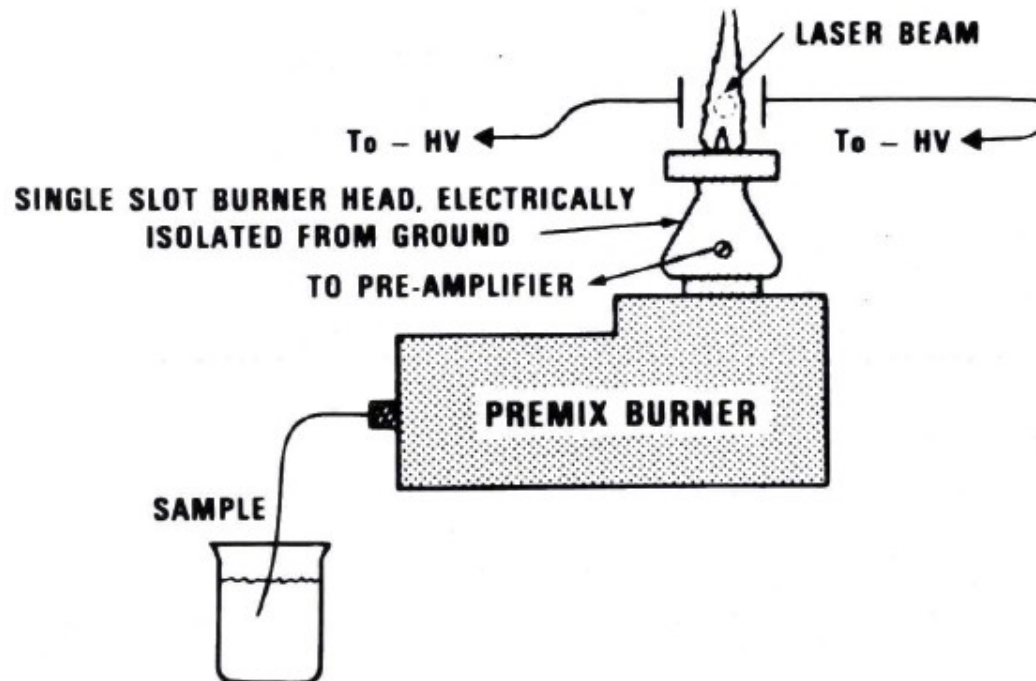

LEI measurement system

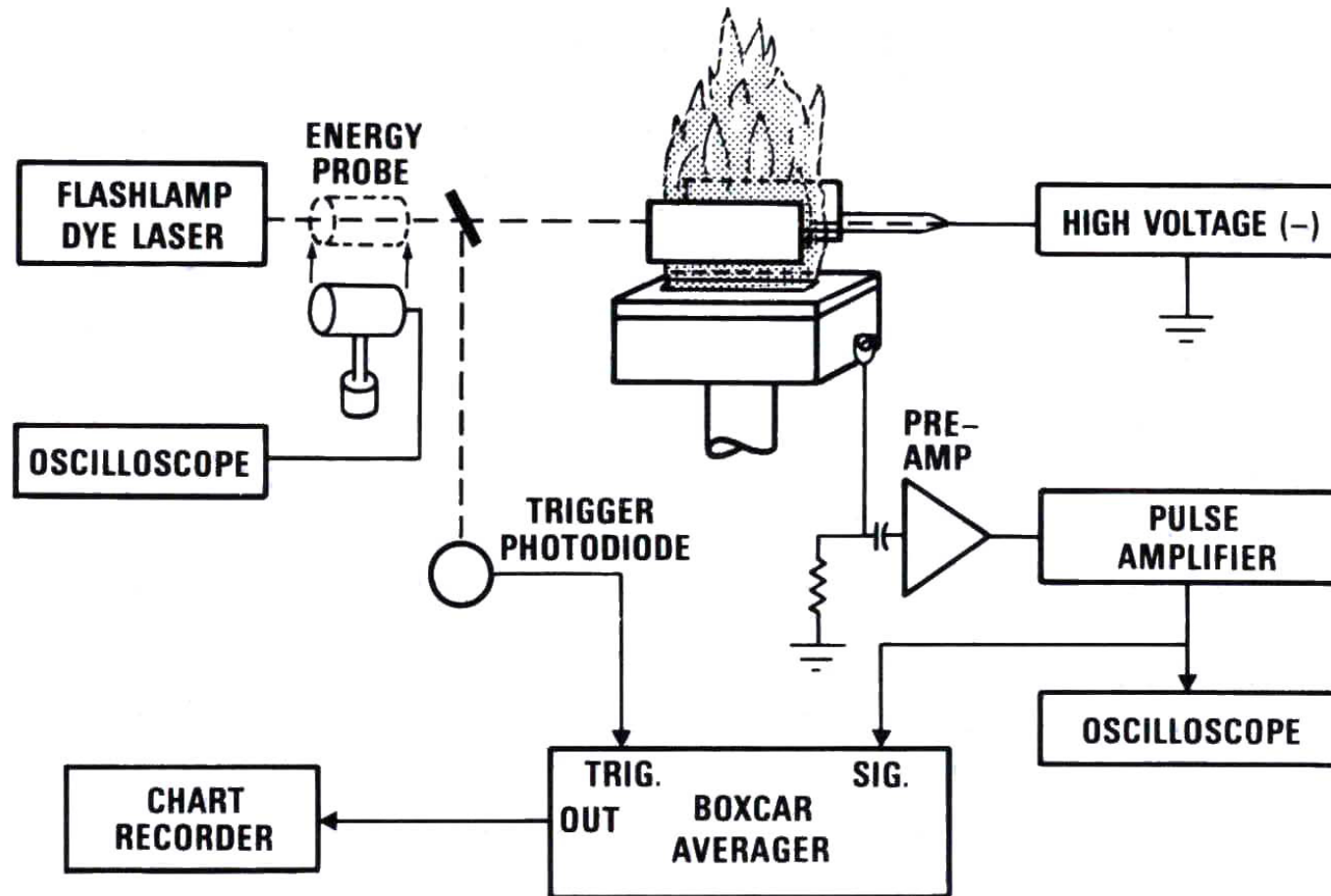

Boxcar integrator

- Also called boxcar averager or gated integrator is mainly used to measure pulse signals, especially to improve the signal / noise ratio:

$$SNIR = \sqrt{\frac{t_{gate}}{t_{cycle}}}$$

- SNIR = signal- t_{gate} ise improvement ratio
- Ratio t_{gate}/t_{cycle} in practice reaches up to 10^{-12} , typically 10^{-6}

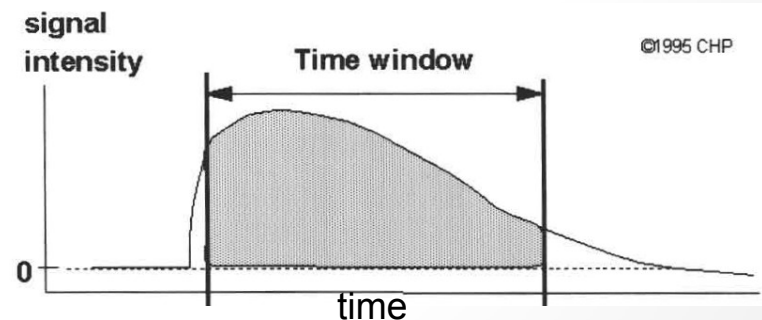
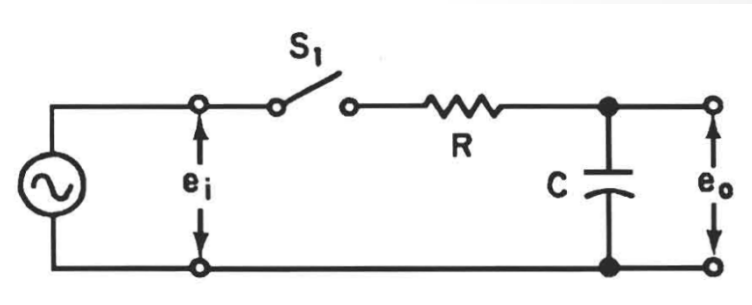

Basic integrator modes

- The integrator can be used as a gateway that transmits periodic signals comparable to pulse duration Δt . The gate opening length can be freely set, including the determination of the sample pulse offset against the measured pulse.
- In the second case, in the time of the pulse waveform scanning is performed. It is also possible to set an arbitrarily wide time window for the selected time resolution of the pulse waveform.

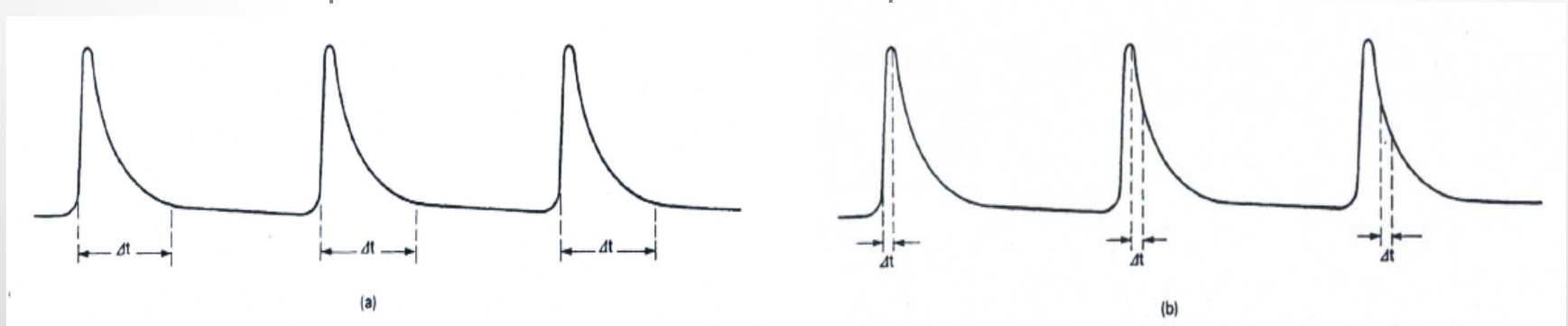

LEI - flame

- Dynamic range of concentrations
- The linear concentration range is 4 - 5 orders of magnitude
- Application in practice to about 20 elements

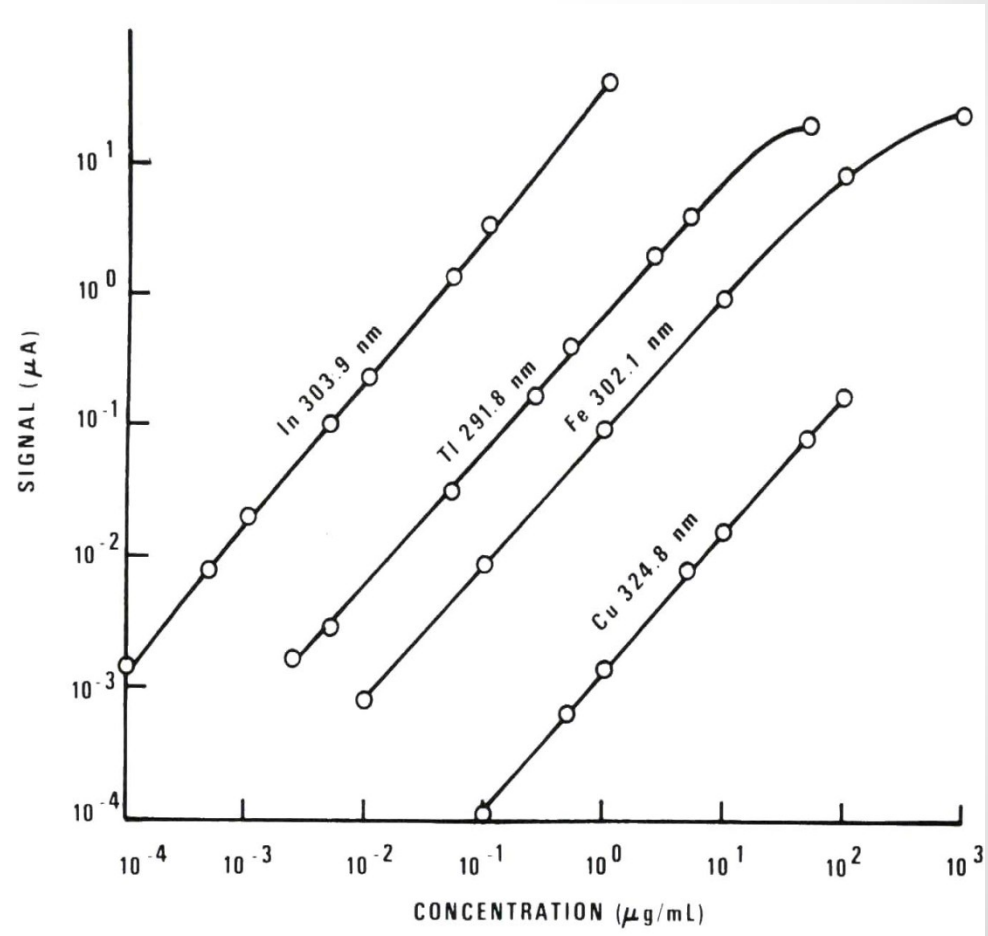

LEI – flame - LOD

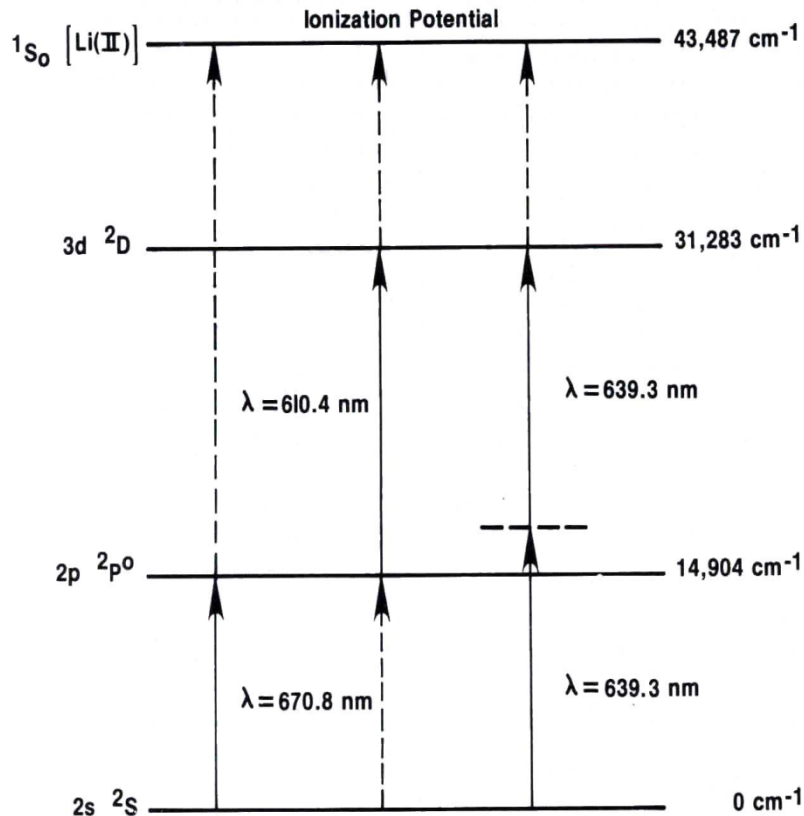

FIG. 9. Partial energy level diagram for Li and detection limits for resonance (670.8 nm), nonresonance (610.4 nm), and two-photon transitions (639.3 nm). LODs are 0.001, 0.012, and 0.4 ng/mL, respectively.

Comparison of Detection Limits (ng/mL)^a

Element	LEI	FAA ^b	F AE ^b	FAF ^b	LIF ^b
Ag	1	1	2	0.1	4
Ba	0.2	20	1	—	8
Bi	2	50	20000	5	3
Ca	0.1	1	0.1	20	0.08
Cr	2	2	2	5	1
Cu	100	1	0.1	0.5	1
Fe	2	4	5	8	30
Ga	0.07	50	10	10	0.9
In	0.008	30	0.4	100	0.2
K	1	3	0.05	—	—
Li	0.001	1	0.02	—	0.5
Mg	0.1	0.1	5	0.1	0.2
Mn	0.3	0.8	1	1	0.4
Na	0.05	0.8	0.1	—	0.1
Ni	8	5	20	3	2
Pb	0.6	10	100	10	13
Sn	6,2 ^c	20	100	50	—
Tl	0.09	20	20	8	4

^aValues taken from references 51 and 6.

^bFlame atomic absorption (FAA), emission (FAE), fluorescence (FAF) and laser induced fluorescence (LIF) in flames.

^cAir/H₂.

LEI – flame - selectivity

- The spectral resolution is determined by the absorption profile of the spectral line and the properties of the measuring radiation.
- Using a sodium dye laser, 589.0 nm was $R \cong 60\,000$
- When using a commercial broadband laser it was $R \cong 8700$ – see fig.

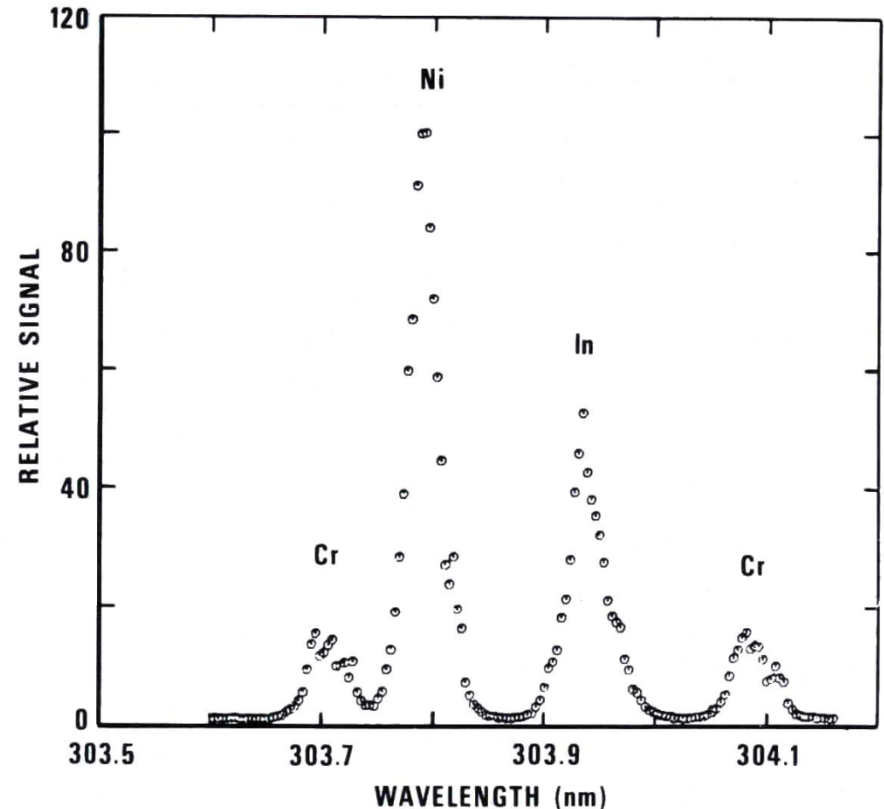

FIG. 7. LEI spectrum of Ni-based alloy near the In analysis line (50, 51). Solution contains 310 $\mu\text{g/mL}$ Ni, 40 $\mu\text{g/mL}$ Cr, and 0.018 $\mu\text{g/mL}$ In.

LEI – absorption of non-resonance transitions

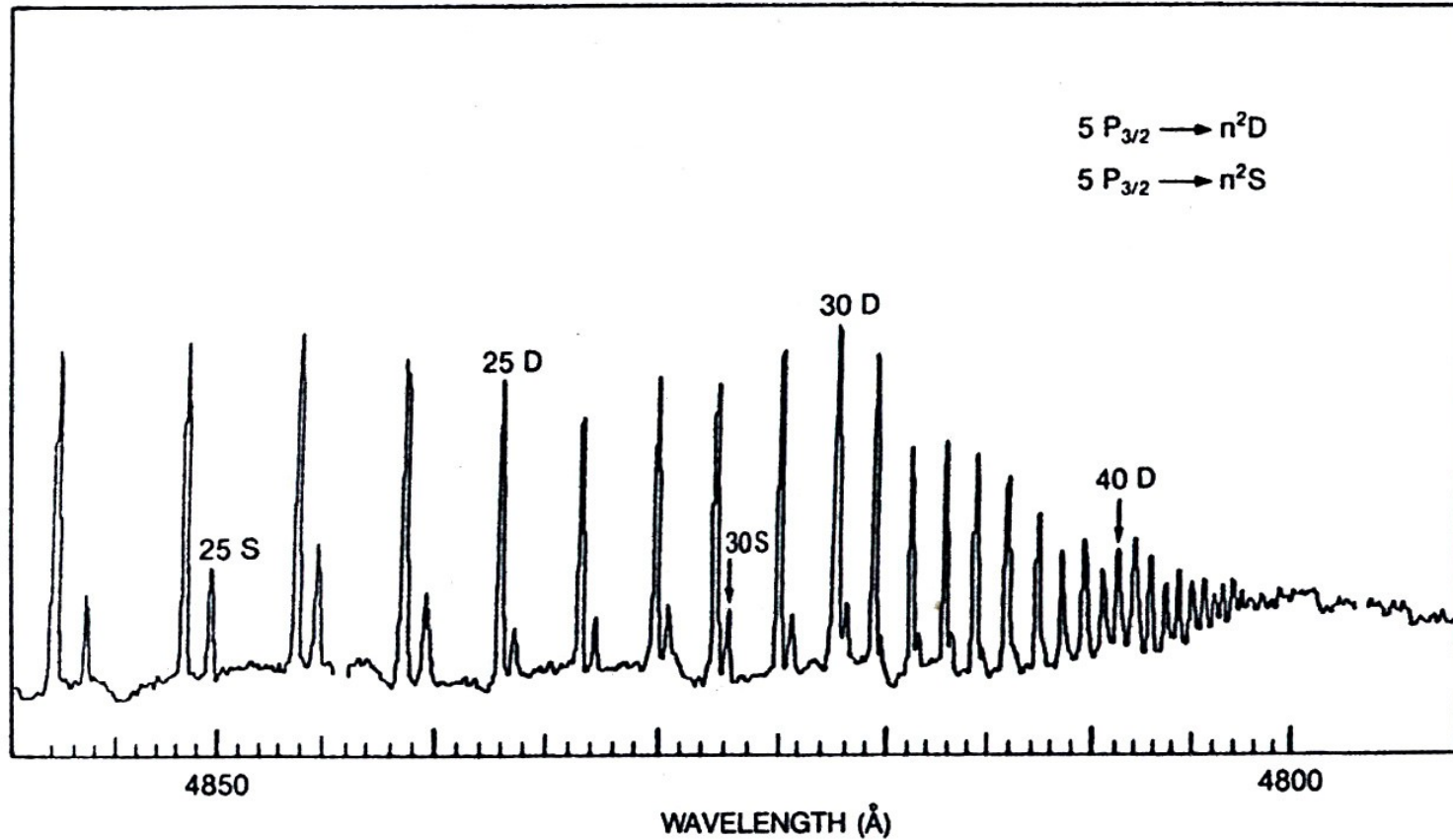

Fig. 4.10 Optogalvanic spectrum of rubidium. Reprinted with permission from [5]

LEI-flame-molecular spectra

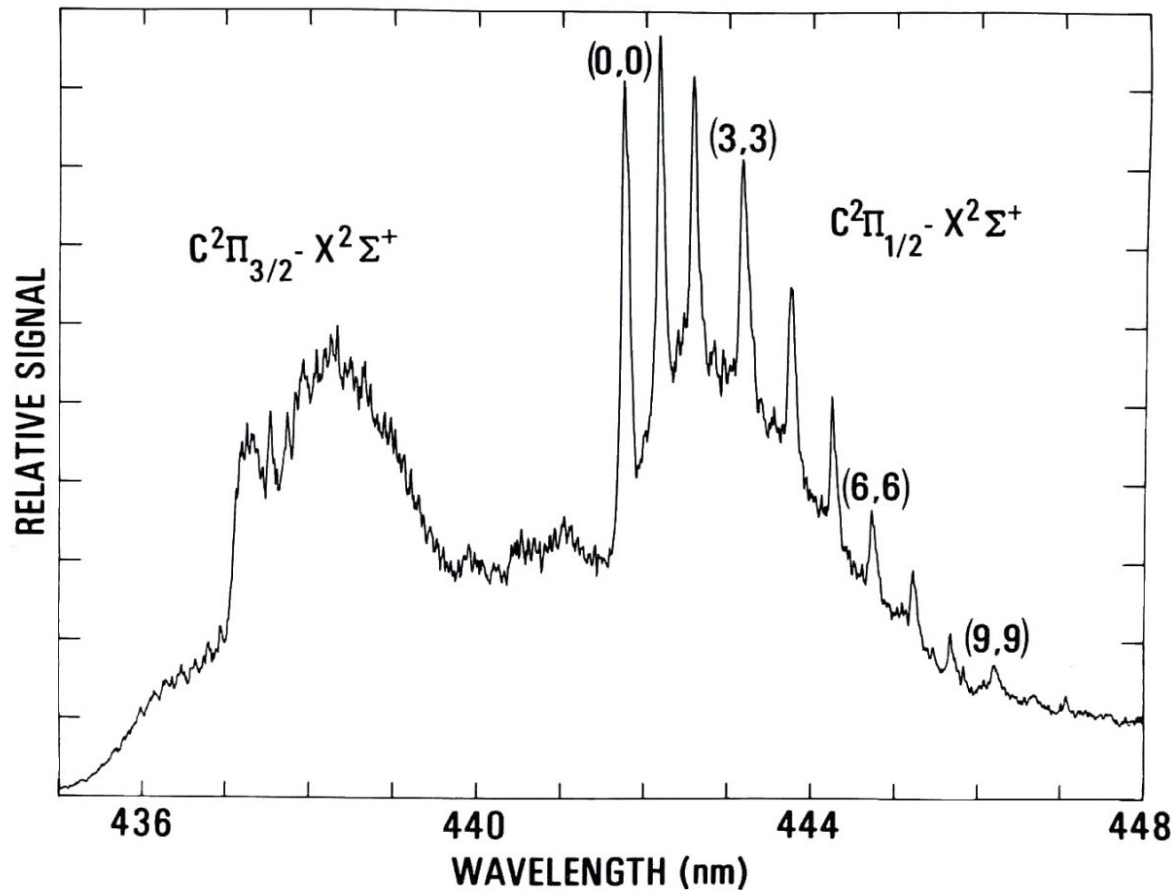

FIG. 8. LEI spectrum of LaO in a flame (54).

LEI - flame

LEI differences from other flame methods:

- It is possible to use non-resonant lines with good sensitivity. E.g. for Li, the 2p level occupation in the flame (Boltzmann) is only $2 \cdot 10^{-4}$ of baseline, but the LOD is only 12 times worse.
- Possibility to use two-photon transitions with good sensitivity
- Low sensitivity for elements with high ionization potential. For elements with $IP > 9 - 10$ eV it would be necessary to work in the vacuum UV region of the spectrum.
- Interference of determination (reduced sensitivity) by easily ionizable matrix elements

OGE electrothermal atomization

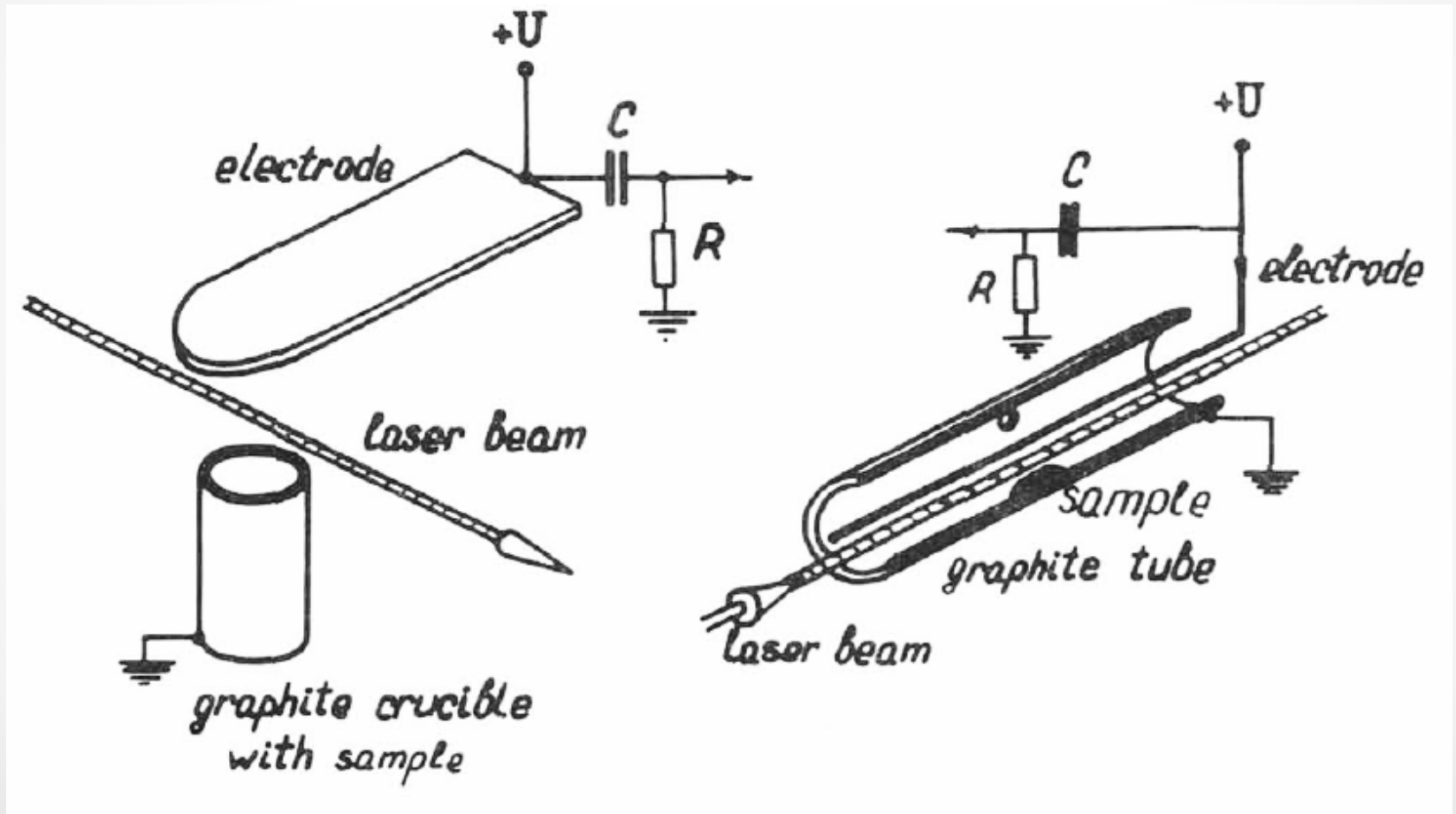

OGE in gas discharges

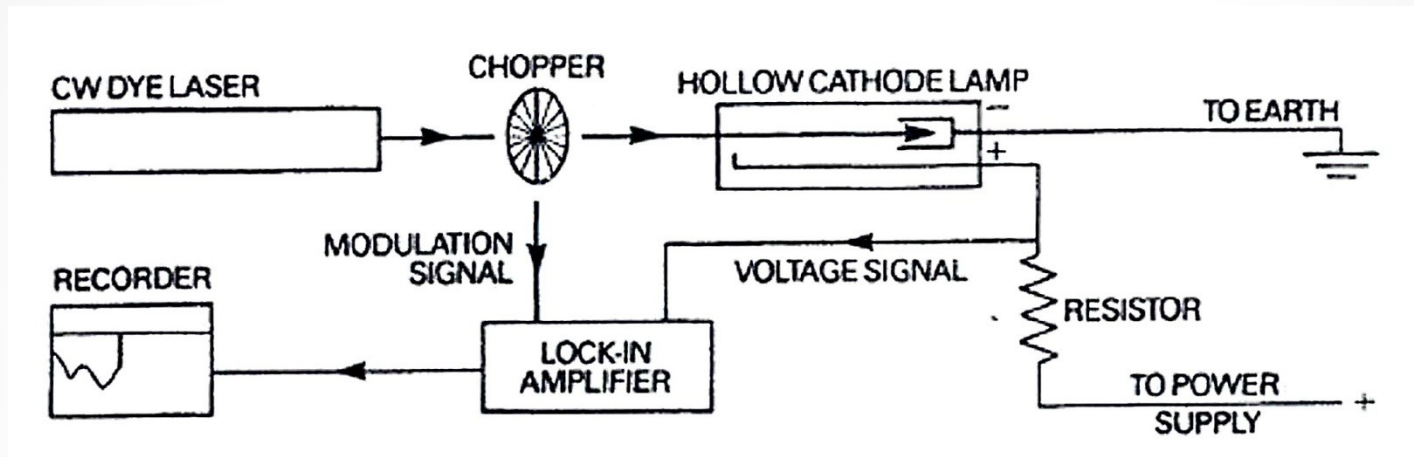

Applications:

Calibration of lasers wavelength using discharge tubes, a hollow cathode without using a complicated optical apparatus (line cathode material and filler gas).

High energy levels can also be excited in discharges, which can be measured by OGE.

Sufficient concentration of atoms even low volatile materials.

Possibilities of Doppler-free spectrometry of atoms and molecules with resolution up to 100 MHz.

Isotope analysis.

Intracavity Optogalvanic Spectroscopy, Ultra-sensitive Analytical Technique for

¹⁴C Analysis *Murnick et al. Anal Chem. 2008 July 1; 80(13): 4820–4824*

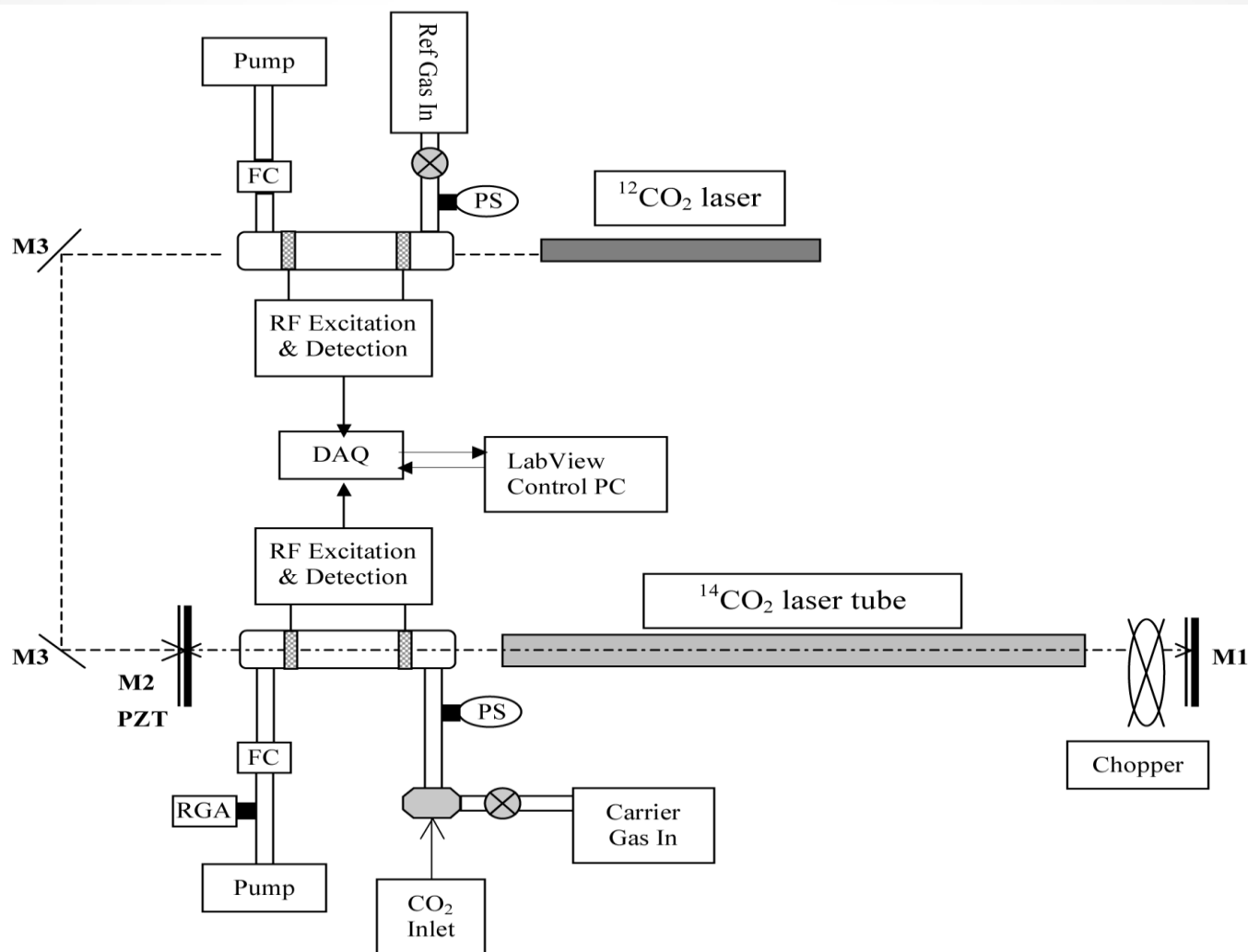

Experimental configuration: The OGE cell inside the cavity has Brewster windows to reduce losses. The C12 laser incident on the OGE cell provides a “C12 signal” that is used for normalization of the C14 signal. The shutter inside the laser cavity is for modulating the ¹⁴CO₂ laser. M1: High reflective mirror & grating, M2: 85% reflective output coupler, M3: Gold plate mirror, PS: Pressure Sensor, FC: Flow Controller, RGA: Residual Gas Analyzer, DAQ: Data Acquisition Board

Experimental results

The OGE signal in response to a laser modulated at 63 Hz. The sample is 5% CO₂ in N₂ at 10⁻¹¹ ¹⁴C enrichment

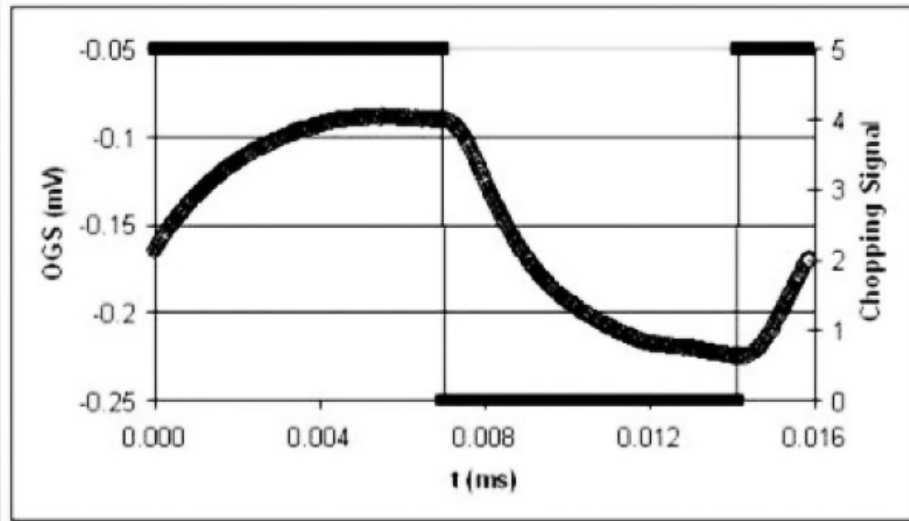

Resonance curve for intracavity optogalvanic effect. The solid line is a best fit Voigt Profile, The width, 48 MHz is expected for ¹⁴CO₂ in the 5 mbar discharge at 385°C

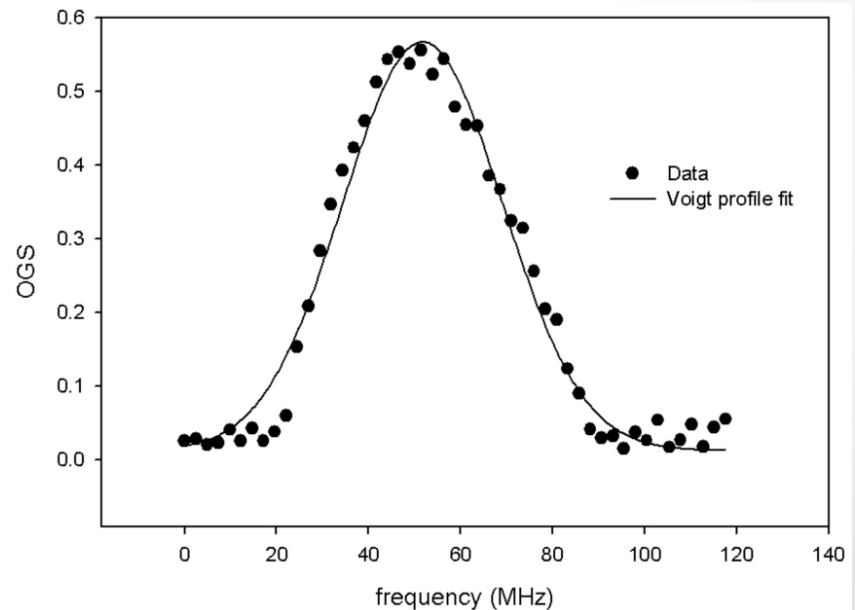

Photoionization - atom detection

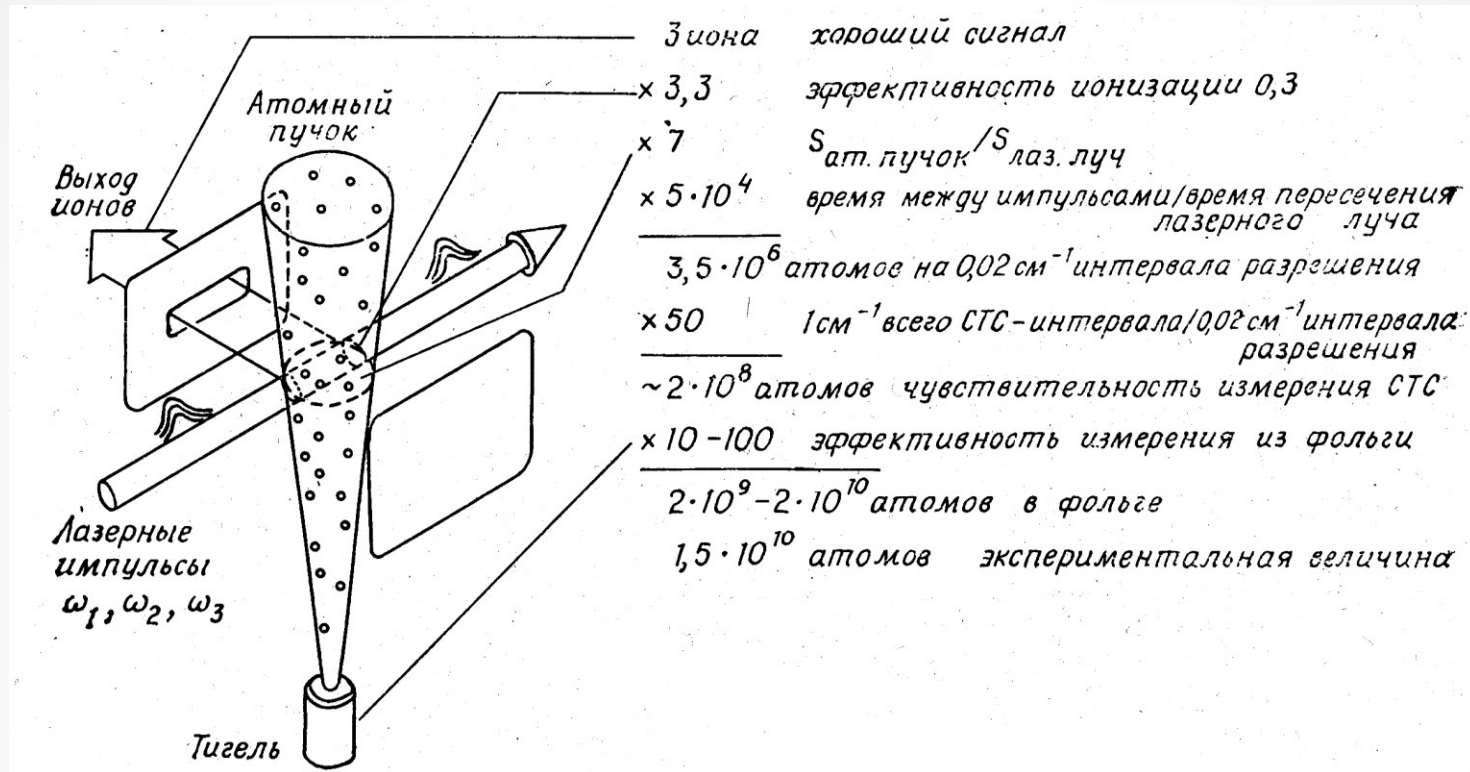

Application of ionization of excited atoms by electric field :

$$E = \frac{5 \cdot 10^9}{16 \cdot n^4} \text{ [Vcm}^{-1}\text{]} \quad n = \text{main quantum number}$$

$P_{\text{las}} = (10^{-6} \div 10^{-4}) \text{ [Jcm}^2\text{]}$, electric field only after the laser pulse is finished (elimination of Stark broadening)