

SPECIATION

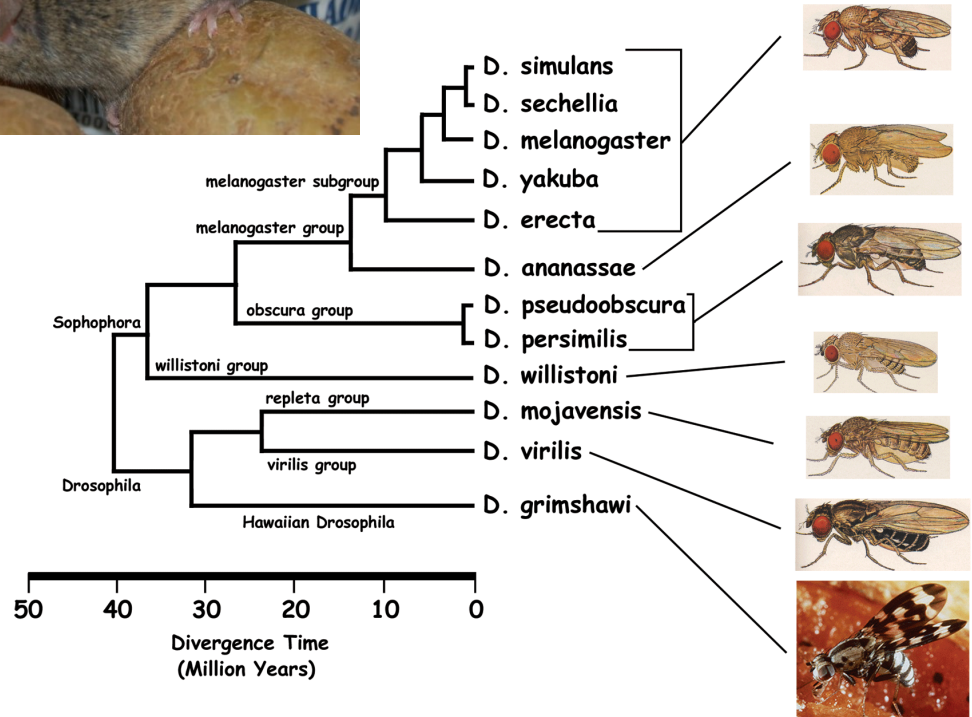

- *E.e. croceator*
- *E.e. eschscholtzii*
- *E.e. klauberi*
- Zone of Hybridization

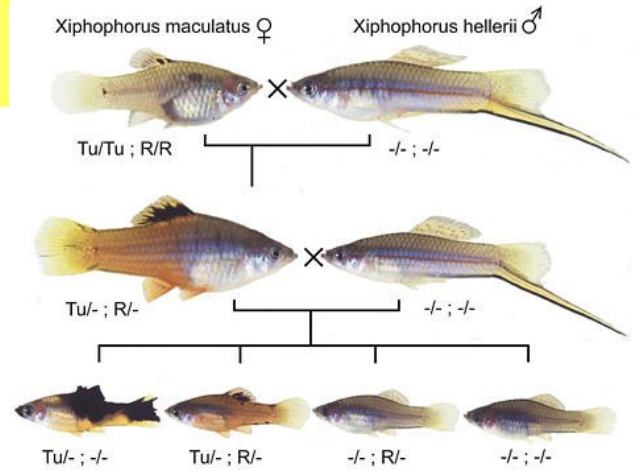
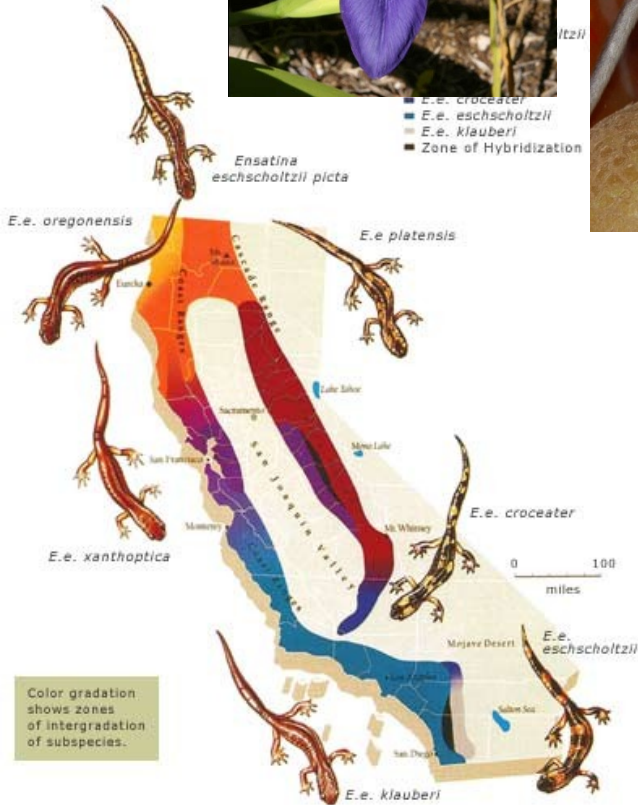

What is species?

How do species arise?





Eurasian nuthatch (*Sitta europea*)

X



common treecreeper
(*Certhia familiaris*)



Mechanisms maintaining species integrity



European herring gull
(*Larus argentatus*)

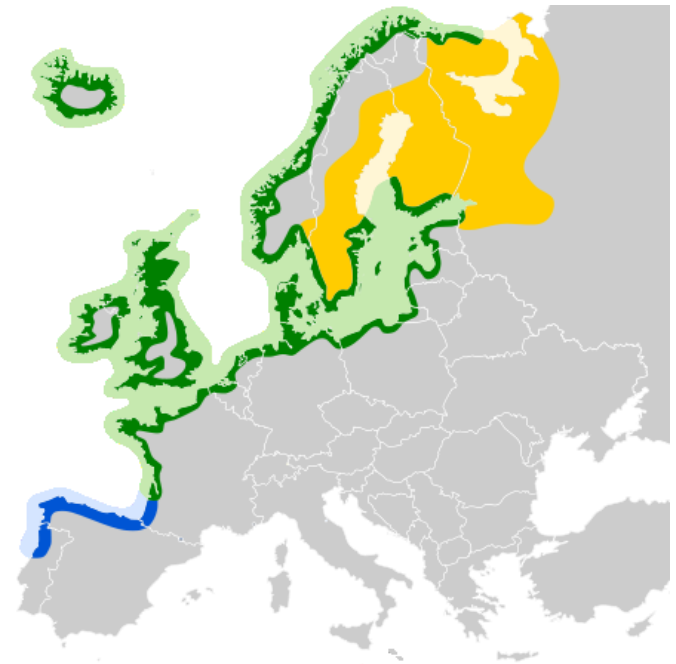

lesser black-backed gull
(*L. fuscus*)

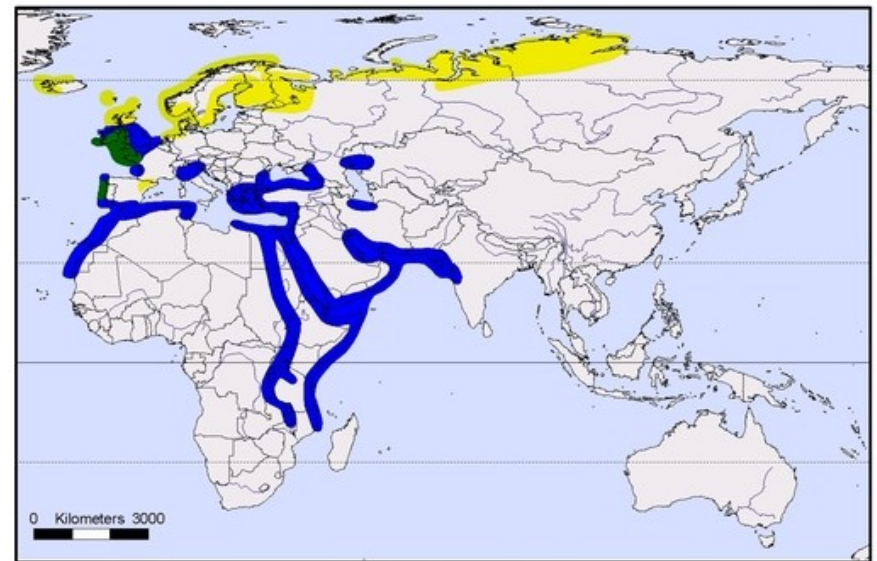

breeding
 feeding, wintering
 resident

Larus fuscus
 digitised by GROMS, after
 del Hoyo et al. 1991-1999,
 www.hbw.com
 Copyright: GROMS/BFN - www.groms.de

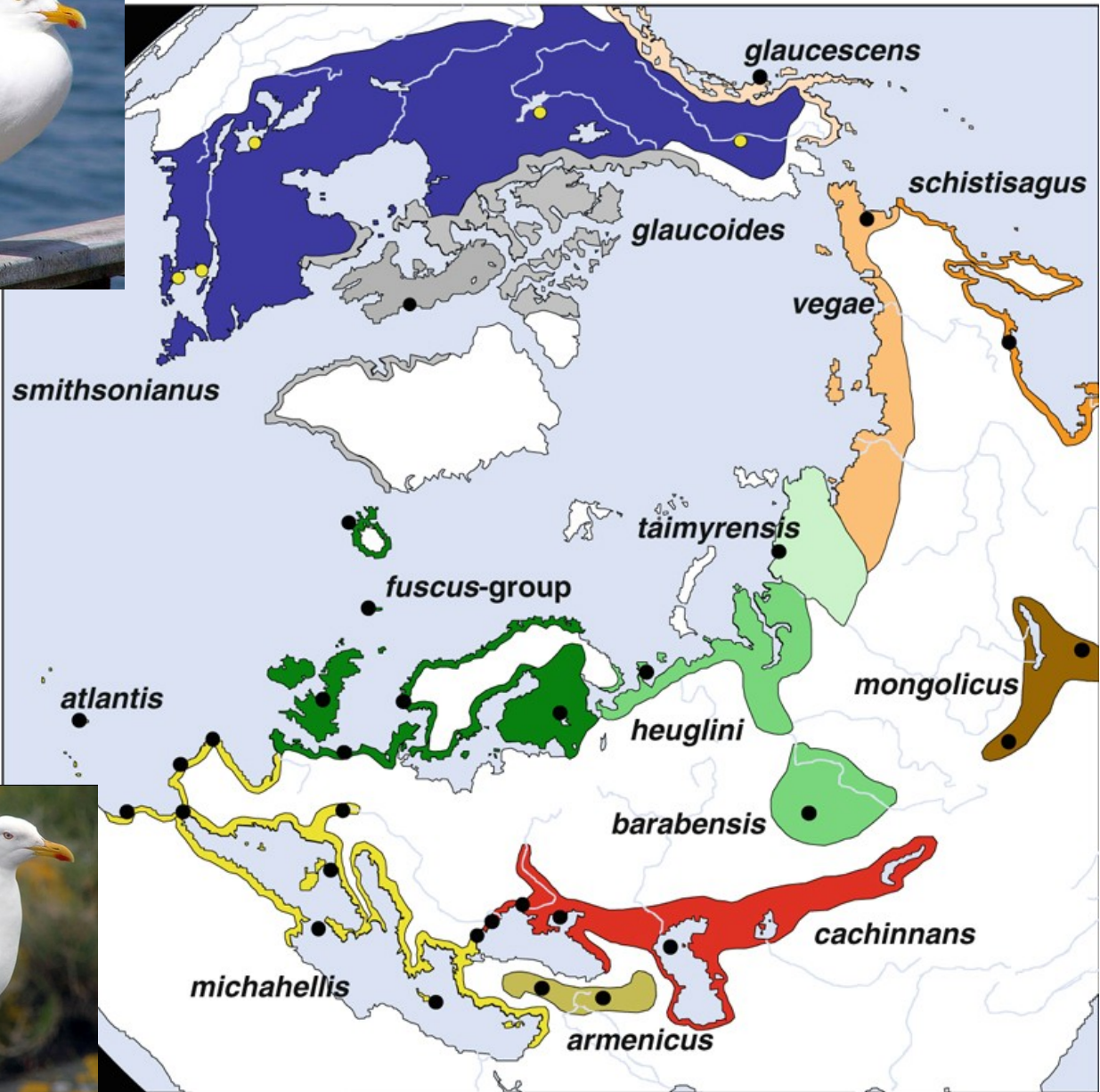

Antics:

species unstable and highly variable

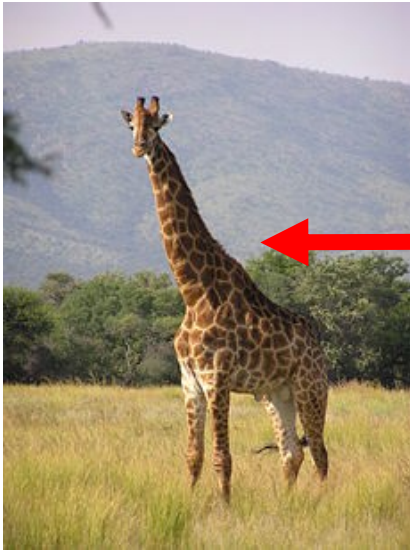

Are species real entities?

nominalists:

no universals and abstract objects (= only words), only particulars exist

eg. [William of Ockham](#), popular in France in the 1700s (young [Buffon](#) and [Lamarck](#)), [Darwin](#)

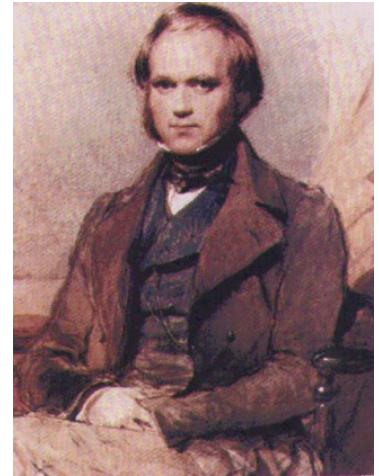
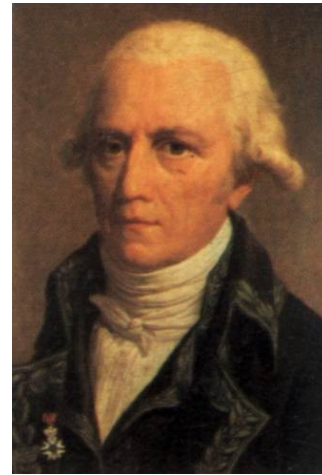
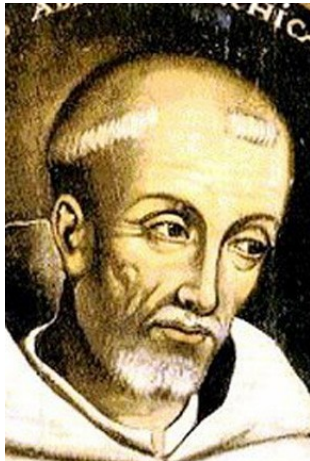

species are human abstractions, artificially dividin natural continuum

according to Darwin classification of organisms to a large extent arbitrary:

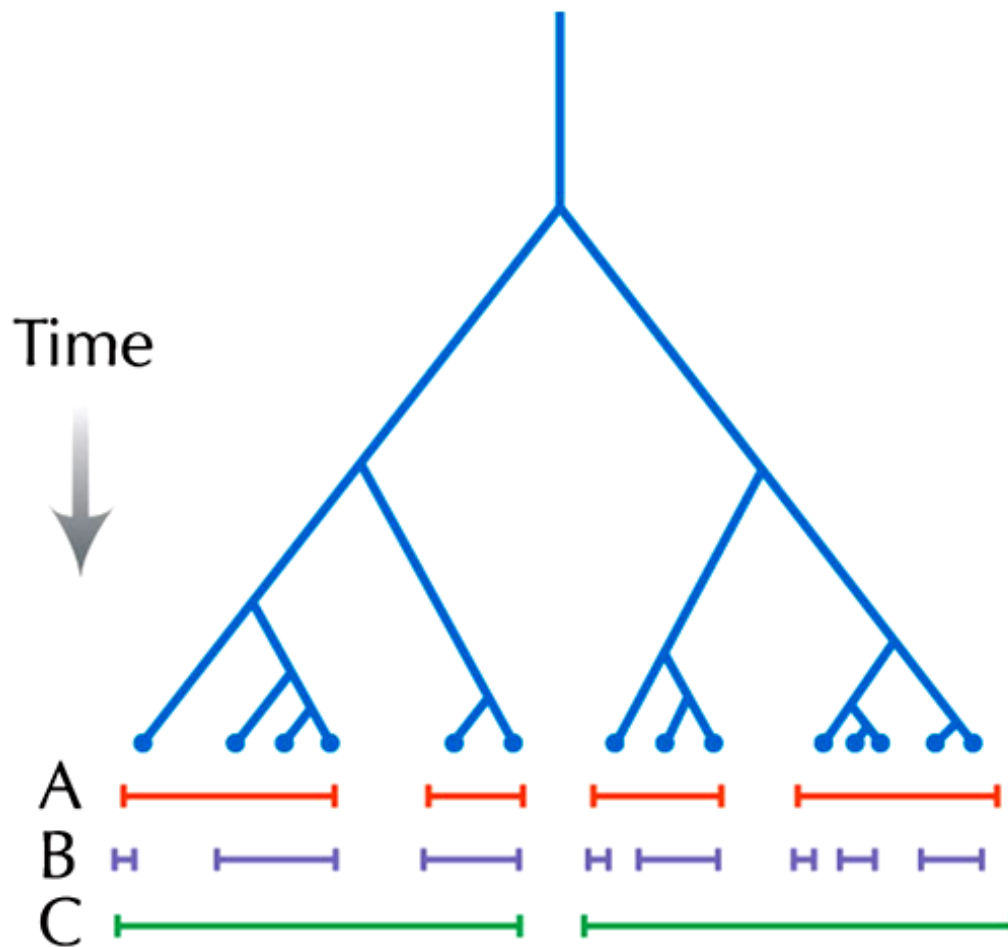

realists:

only universals are real, particulars are derived, random, variable, and ephemeral

eg. Plato



species really exist in nature

New Guinea tribes:

Karam people → almost identical discrimination of bird species with western taxonomists (but bats considered as birds)

Rofaifo people → only two names for mammals (small = Hunembe, big = Hefa); cassowary considered as a mammal

× human brain same in aborigines and professional taxonomists

free hybridization within species × rare between species

Problem: definition should be both universal and operational

Typological (essentialist) concept

Plato's world of ideas: assumption of existence of limited number of types (universals)

species composed of individuals having the same essence

variability strongly limited, results from imperfect expression of the idea

each species separated from others by sharp boundary

constant in time

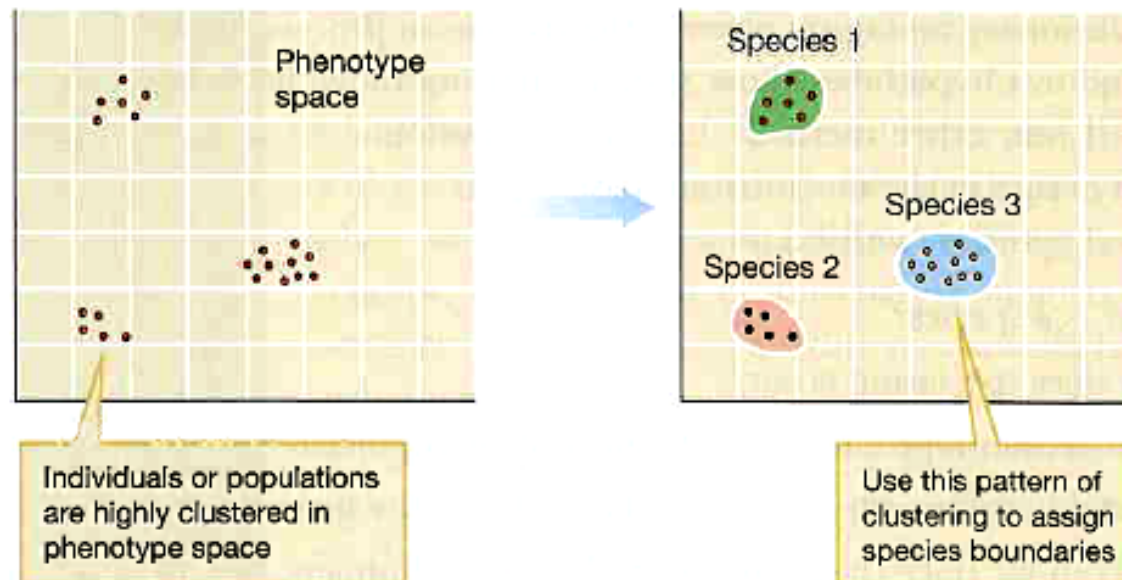

× sexual dimorphism

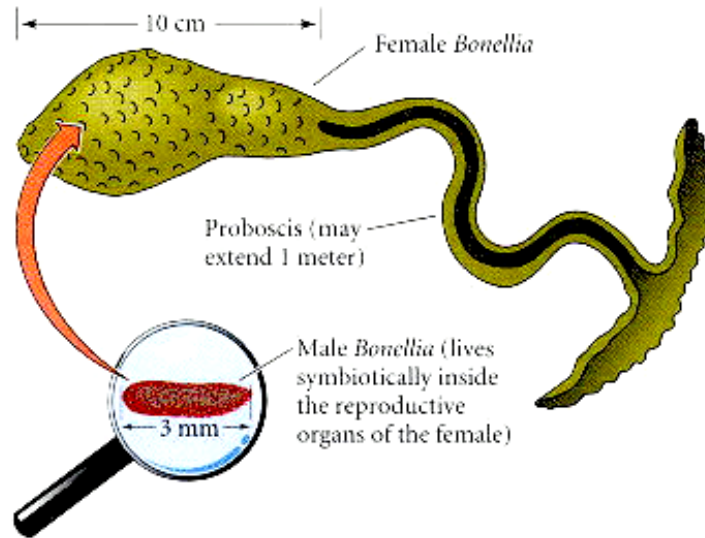

Bonellia viridis

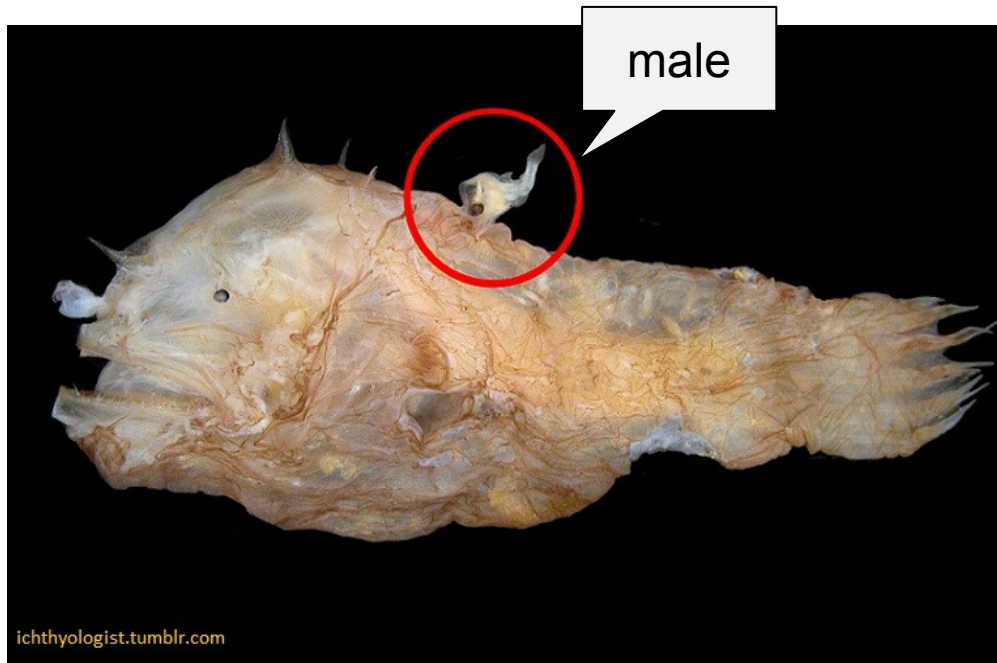

angler
(*Lophius piscatorius*)

× polymorphism, different ontogenetic stages

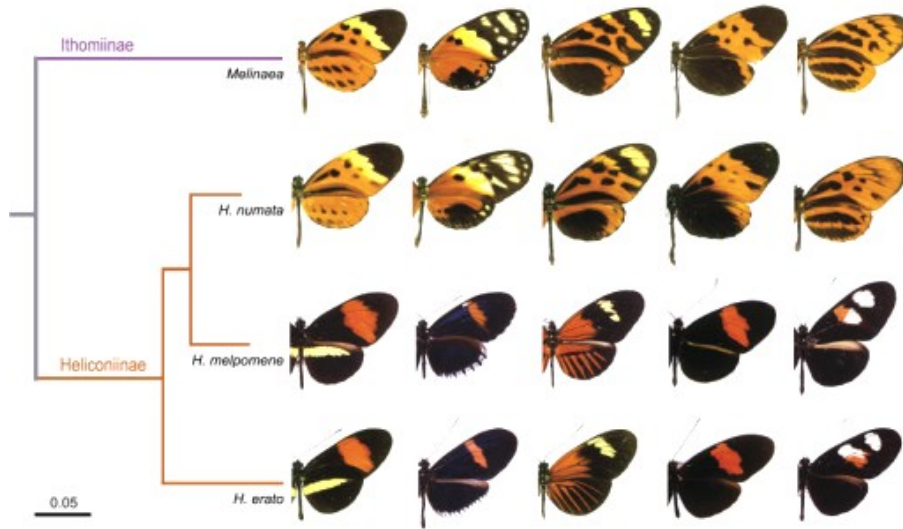

Heliconius spp.



Papilio polyxenes

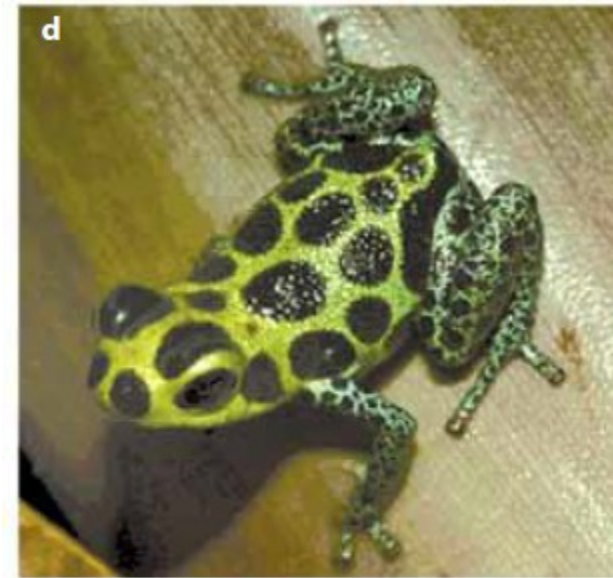

Ranitomeya imitator

× sibling species, cryptic species



Drosophila persimilis/
D. pseudoobscura



Pipistrellus pipistrellus/*P. pygmaeus*



Certhia brachydactyla/*C. familiaris*

Typological species still in nomenclatorial practice:
type specimen = holotype, type series, type locality

barcoding

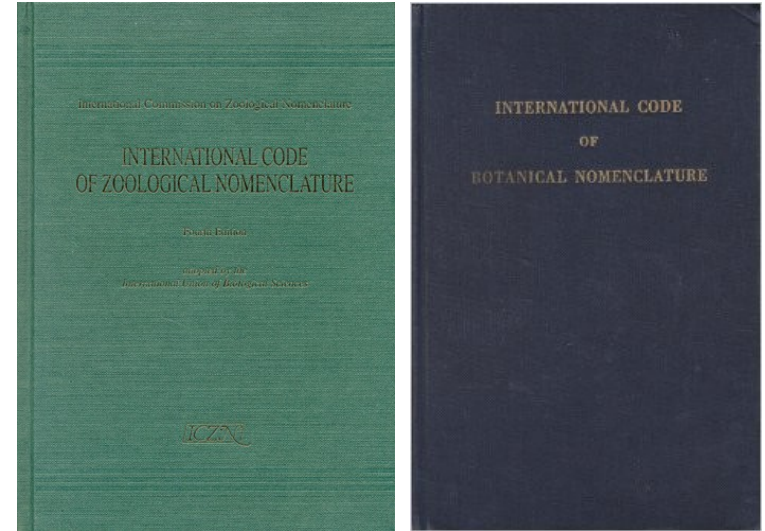
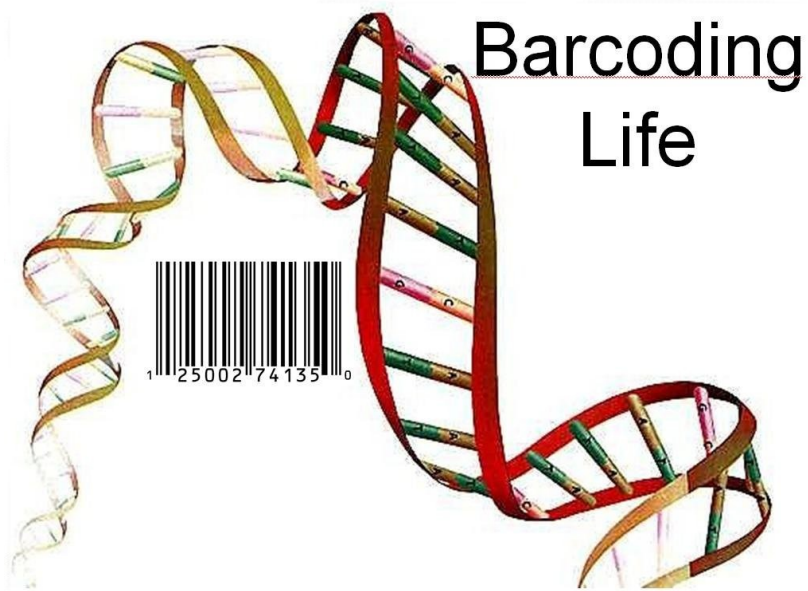

DNA-based Identification System

Universal Product Code



- Ten unique states
- Twelve distinct positions

DNA Barcode



- Four unique states
- Over 600 positions

Biological species concept (BSC)

T. Dobzhansky, H. Muller, J. Huxley, E. Mayr

species as gene pools, reproductive communities
reproductively isolated from others

no constant, „essential“ characters

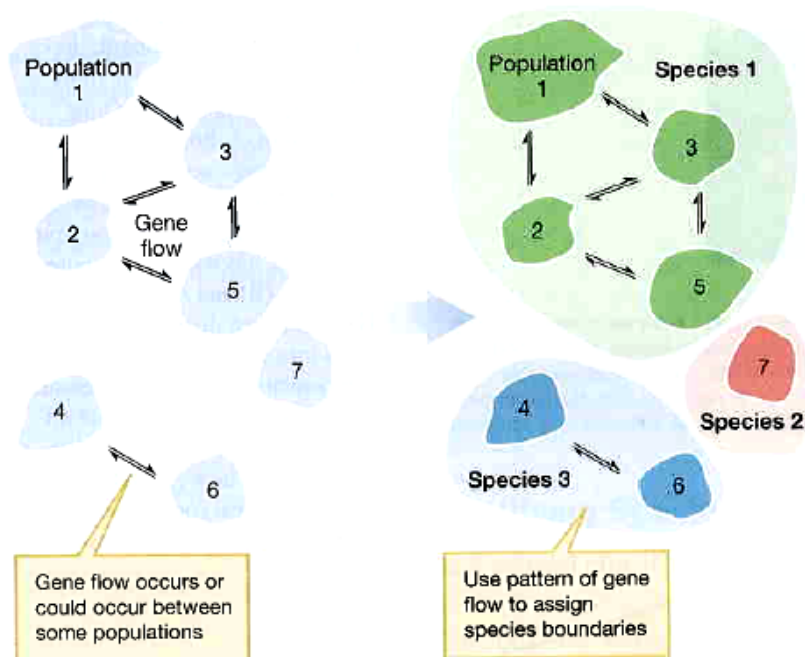

E. Mayr

Ernst Mayr (1942):

Species are groups of interbreeding natural populations that are reproductively isolated from others such groups.

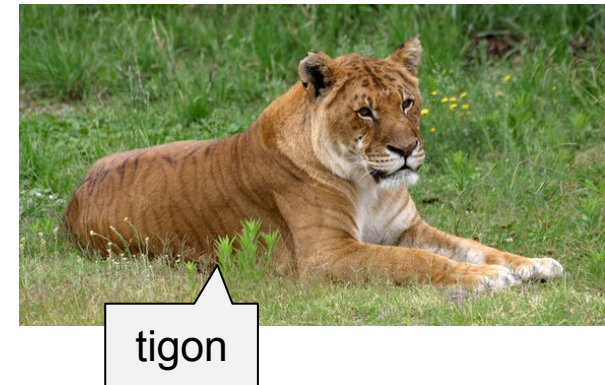
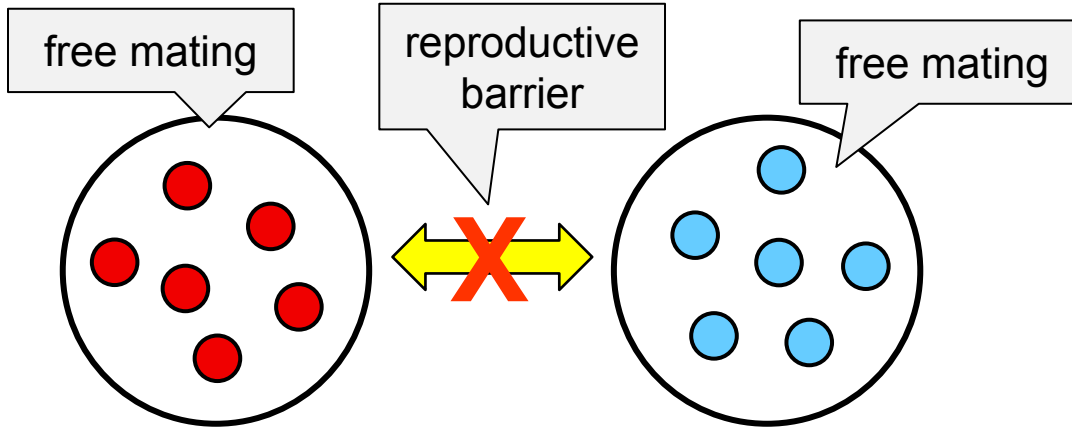

Limitations and problems of biological species:

only sexual organisms

problems in allopatry („potential“ hybridization) \Rightarrow auxiliary morphological and genetic criteria (degree of divergence \sim degree of reproductive isolation)

problems in palaeontology – populations are not contemporary

hybridization between „good“ species
(*Bombina bombina* \times *B. variegata*)

auxiliary criteria (DNA sequences)





Quercus gambelii

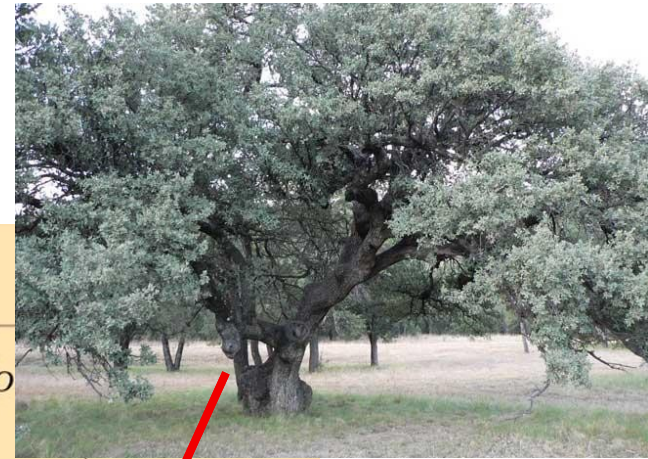

Q. grisea

grisea +
gambelii =
syngameon

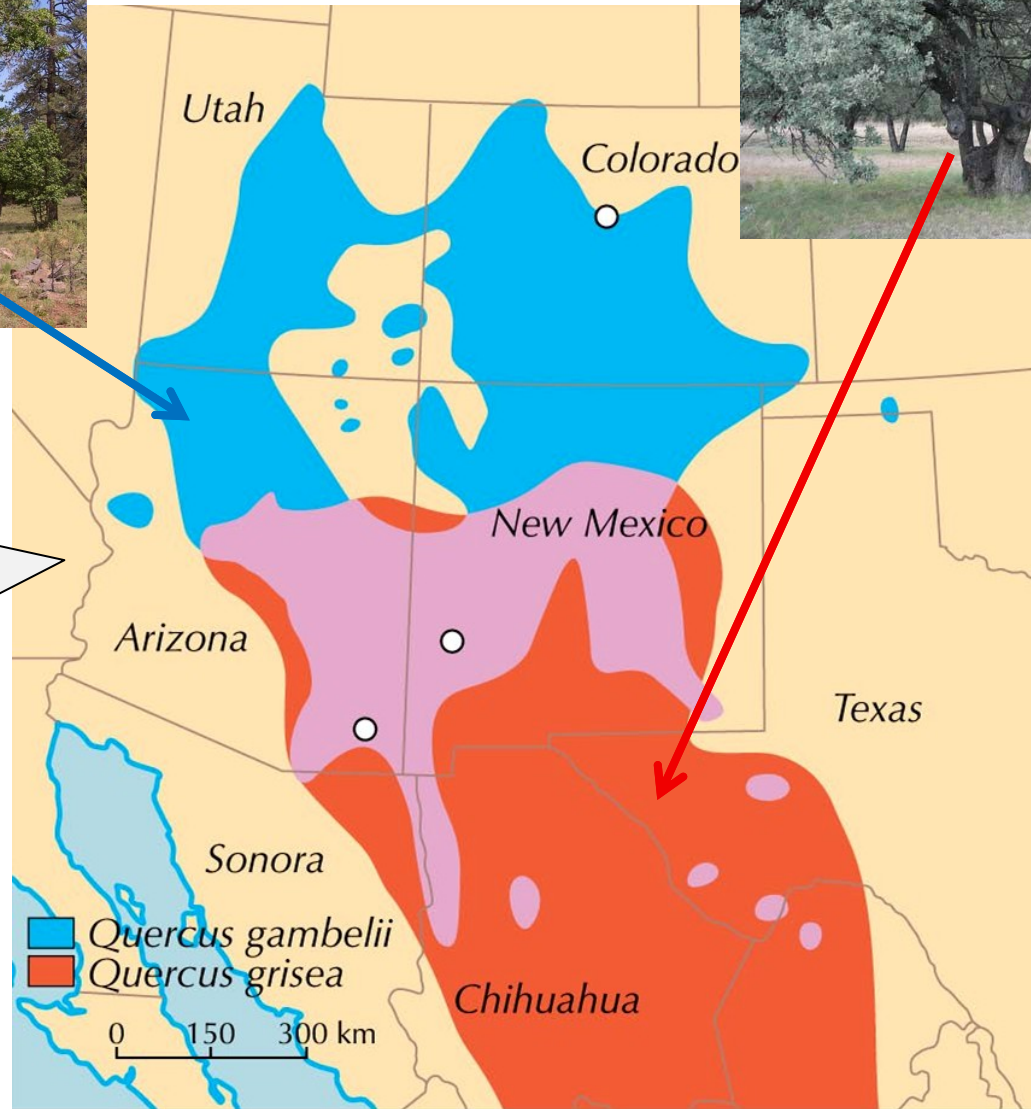

Reproductive barriers

formerly reproductively isolating mechanisms = RIM ... today we prefer the term reproductive barriers (RIM imply „in order to“)!

1. Prezygotic

A) pre-copulatory:

partners do not meet:

seasonal (temporal)

eg. fireflies, crickets *Gryllus pennsylvanicus* (autumn) × *G. veletis* (spring)

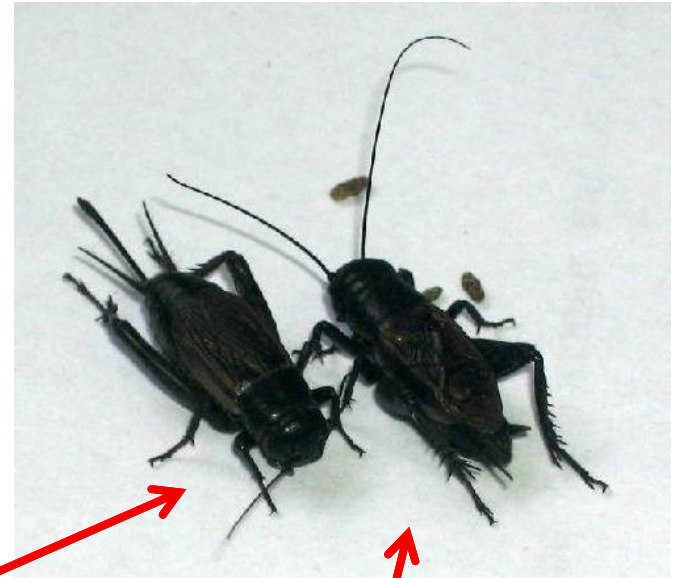

ecological (habitat):

Viola arvensis (chalk soils) × *V. tricolor* (acidic soils),
hybrids limited to neutral or weakly acidic soils



1. Prezygotic

A) pre-copulatory:

partners meet but do not mate:

ethological, behavioral, sexual

signals:

- acoustic



lacewing (*Chrysoperla*)



Reproductive barriers

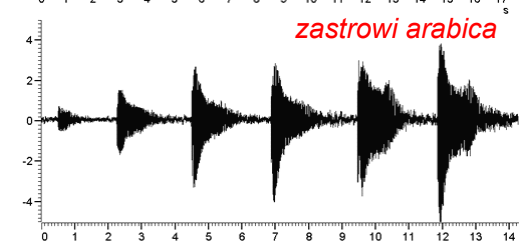
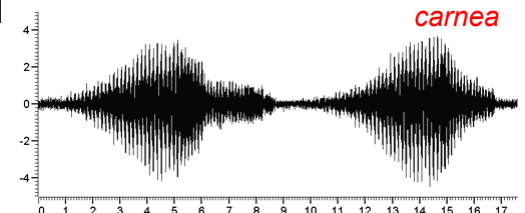
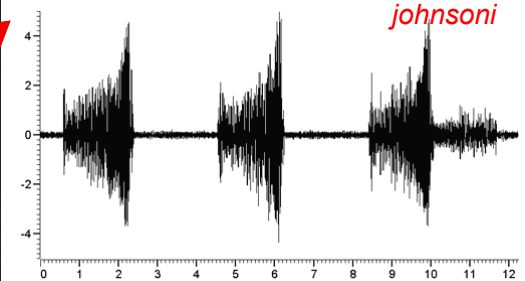
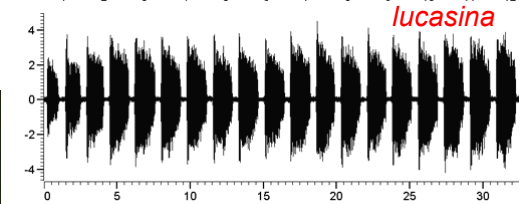
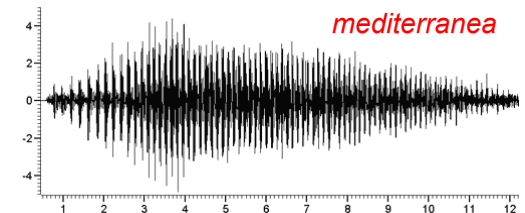

1. Prezygotic

A) pre-copulatory:

partners meet but do not mate:

ethological, behavioral, sexual

signals:

- acoustic
- chemical
- light



firefly's track

1. Prezygotic

A) pre-copulatory:

partners meet but do not mate:

ethological, behavioral, sexual

signals:

- acoustic
- chemical
- light
- behavioral (eg. wedding dances)



grey-crowned crane (*Balearica regulorum*)

black-necked stilt (*Himantopus mexicanus*)



great bustard (*Otis tarda*)



red-crowned crane (*Grus japonensis*)

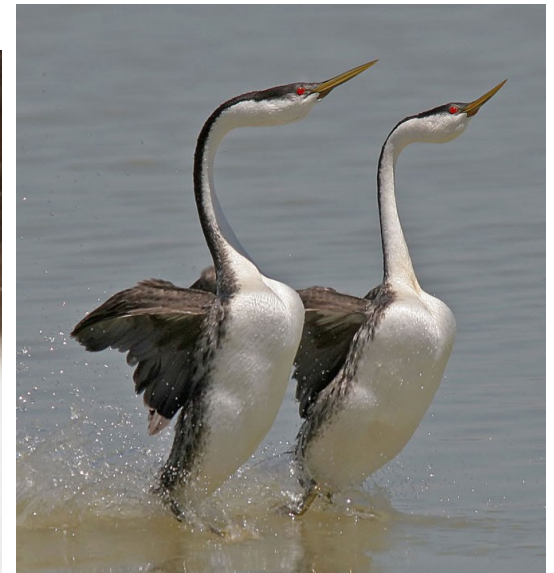

western grebe
(*Aechmophorus occidentalis*)

signals:

- acoustic
- chemical
- light
- behavioral (eg. wedding dances)
- different pollinators in plants



Reproductive barriers

1. Prezygotic

B) post-copulatory:

partners mate but without transfer of gametes:

mechanical:

- especially plants; in animals shape of genitalia



cat



os penis



walrus (fossil: 1,2 m and recent: 56 cm)



fox

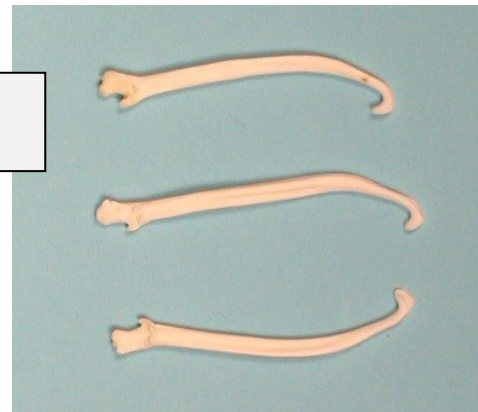

mink

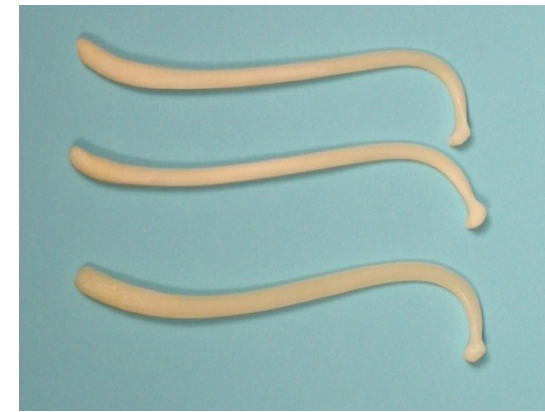

racoon

1. Prezygotic

B) post-copulatory:

transfer of gametes occur but without fertilization:

gametic incompatibility

external fertilization: esp. marine invertebrates (mollusks, echinoderms)

internal fertilization: eg. *Drosophila* – sperm cannot survive in spermatheca of females of other species

plants: pollen tube grows through style

2. Postzygotic

inviability of F1 hybrids

sterility of F1 hybrids

reduced viability or fertility of F2 or backcrosses
= hybrid dysgenesis

Haldane's rule:

When in the F1 offspring of two different animal races one sex is absent, rare, or sterile, that sex is the heterozygous (heterogametic) sex.*)

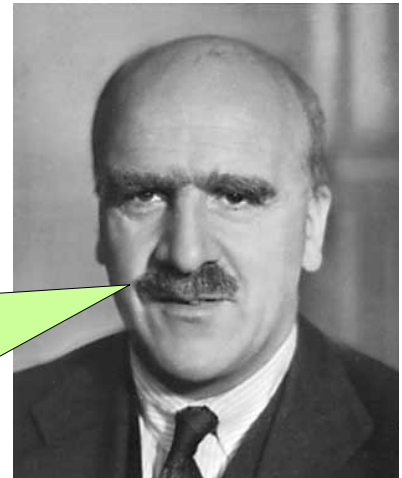

*) *Drosophila* type – males (XY); *Abraxas* type – females (WZ)

Haldane's rule explains **Large X effect**: genes having large impact on postzygotic reproductive isolation are usually located on X chromosome

dominance theory

(Muller 1940, 1942; Orr 1997):

males – both dominant and recessive alleles of X-linked genes

females – only dominant alleles



Drosophila pseudoobscura × *D. persimilis*

Rate of prezygotic isolation between allopatric species is similar to rate of postzygotic isolation ...

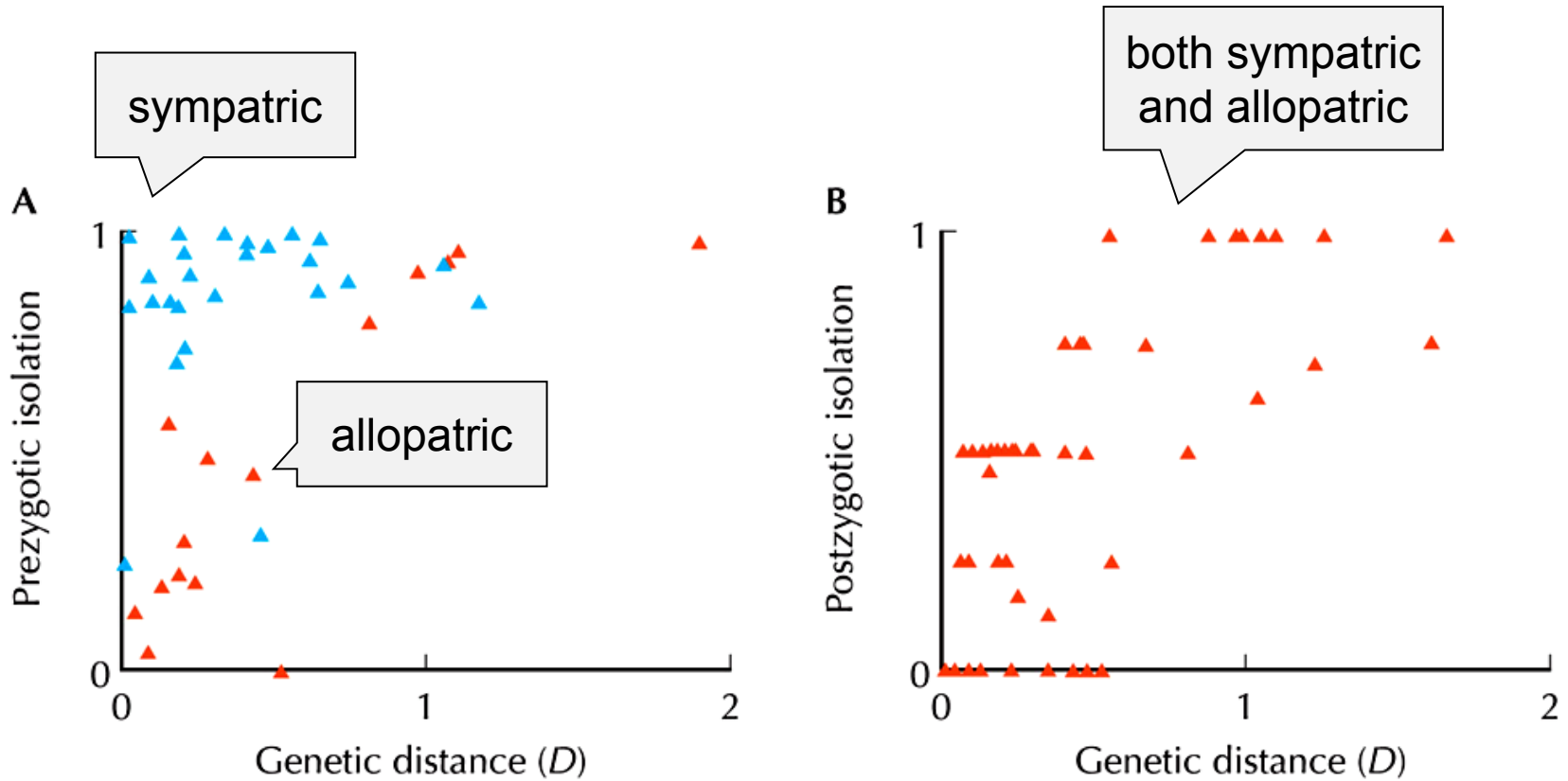

... prezygotic isolation between sympatric/parapatric species arises more rapidly

Concepts related to biological species:

Recognition species concept

Hugh E.H. Paterson (1985)

emphasizes shared fertilization system rather than isolation:

specific mate recognition system (SMRS)

courtship, timing of mating, choice of condition, coloration, endocrine system, shape of copulatory organs, gametic compatibility, ...

reproductive isolation as a byproduct

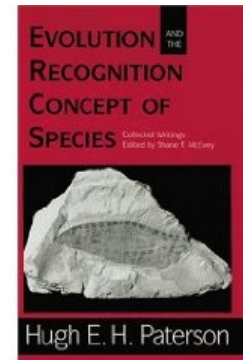

Concepts related to biological species:

Cohesion species concept

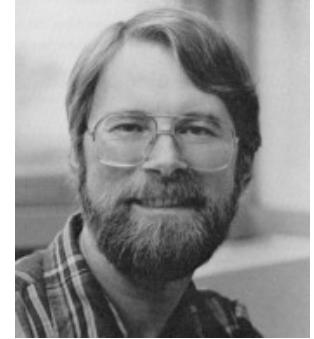

Alan R. Templeton (1989)

emphasizes mechanisms maintaining morphological stability of populations

cohesion mechanisms: gene flow, stabilizing selection, ontogenetic constraints, reproductive isolation

application also to asexual organisms, possibility of interspecific hybridization

Evolutionary species concept

attempts for vertical species concepts

George Gaylord Simpson (1961):
phyletic speciation, chronospecies
asexual organisms

temporal perspective

biological species is a part of it

Edward O. Wiley (1978):

„A species is a lineage of ancestral descendant populations which maintains its identity from other such lineages and which has its own evolutionary tendencies and historical fate.“

contrary to Simpson's concept Wiley admits only cladogenesis,
ie. splitting speciation

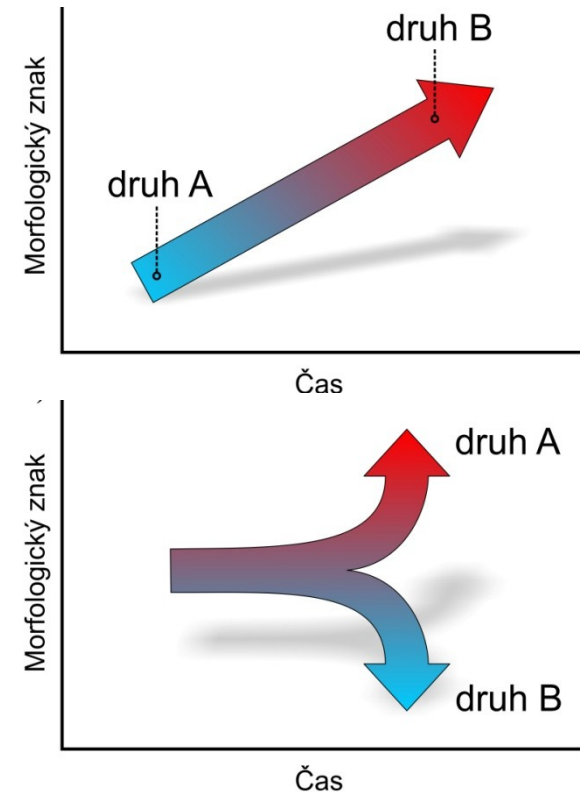
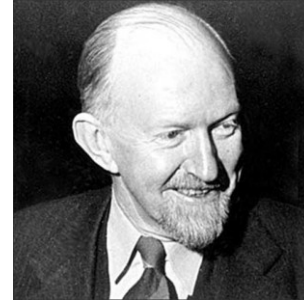

Phylogenetic species concept

emphasis on diagnostic criteria → but which ones?

⇒ primary inference of phylogeny (synapomorphies)

Phylogenetic species = smallest monophyletic group distinguished by a shared derived trait

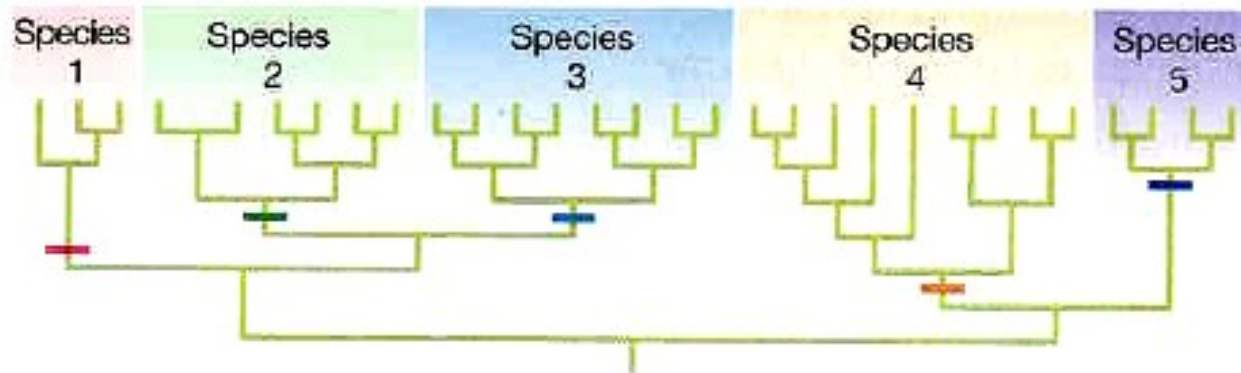

Relation of biological and phylogenetic species:

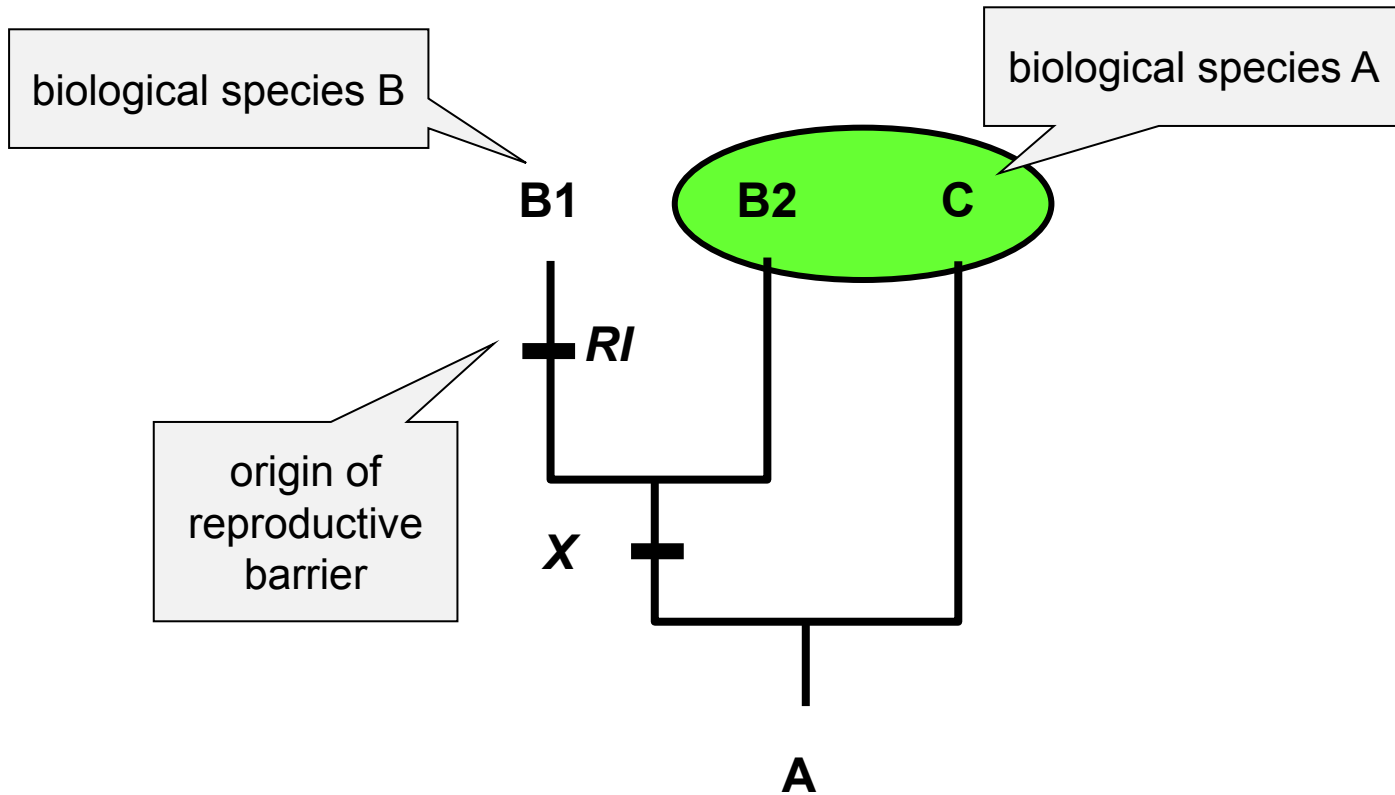

Relation of biological and phylogenetic species:

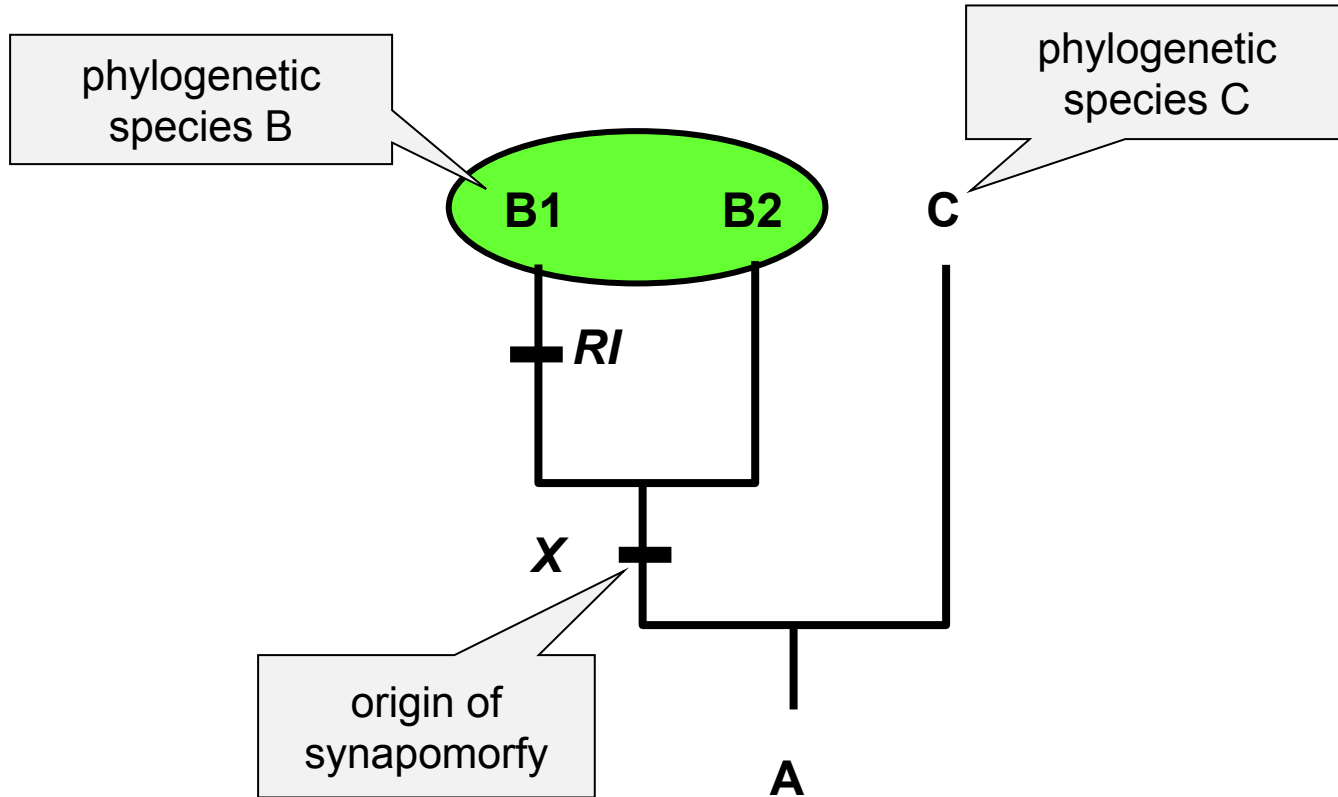

SPECIATION

- geography:**
- | | |
|-----------------------------|-------------------------------------------------------------|
| allopatric
(isolation) | allopatric
peripatric
allo-parapatric (reinforcement) |
| sympatric
(no isolation) | parapatric
sympatric |
- mechanism:**
- drift
 - selection
 - sexual selection
 - hybridisation
 - polyploidisation
- genetic elements:** genes vs. chromosomes (stasipatric speciation)

Allopatric speciation

geographic isolation

advancing divergence: mutation, drift, selection, sexual selection

reproductive barriers as a byproduct

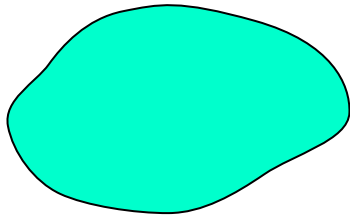
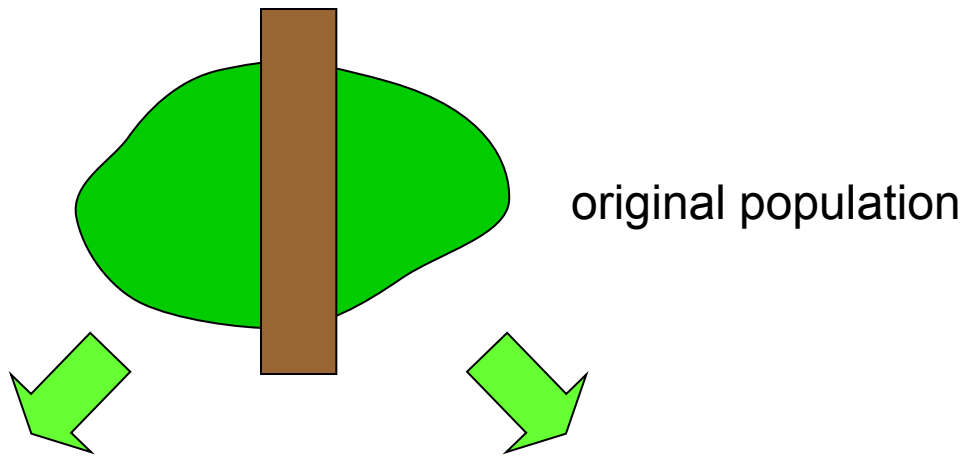

mutation
drift
selection
⇒ divergence

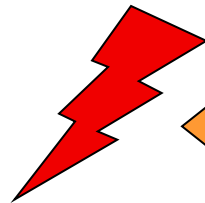
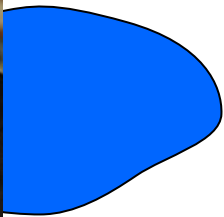
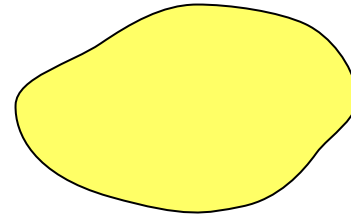

incompatibility

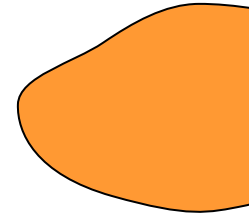
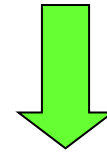

Dobzhansky-Muller model:



W. Bateson



T. Dobzhansky



H. Muller

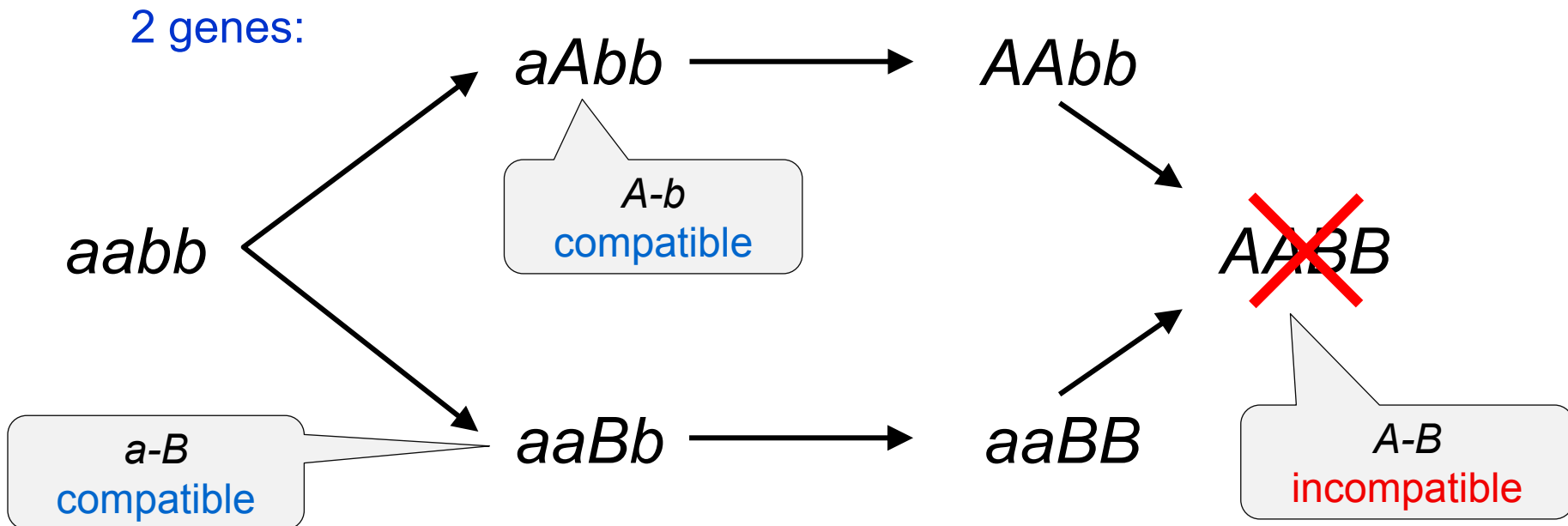

large population

allopatric speciation usually slow (exceptions: sexual selection, genetic conflict)

genetic conflict:

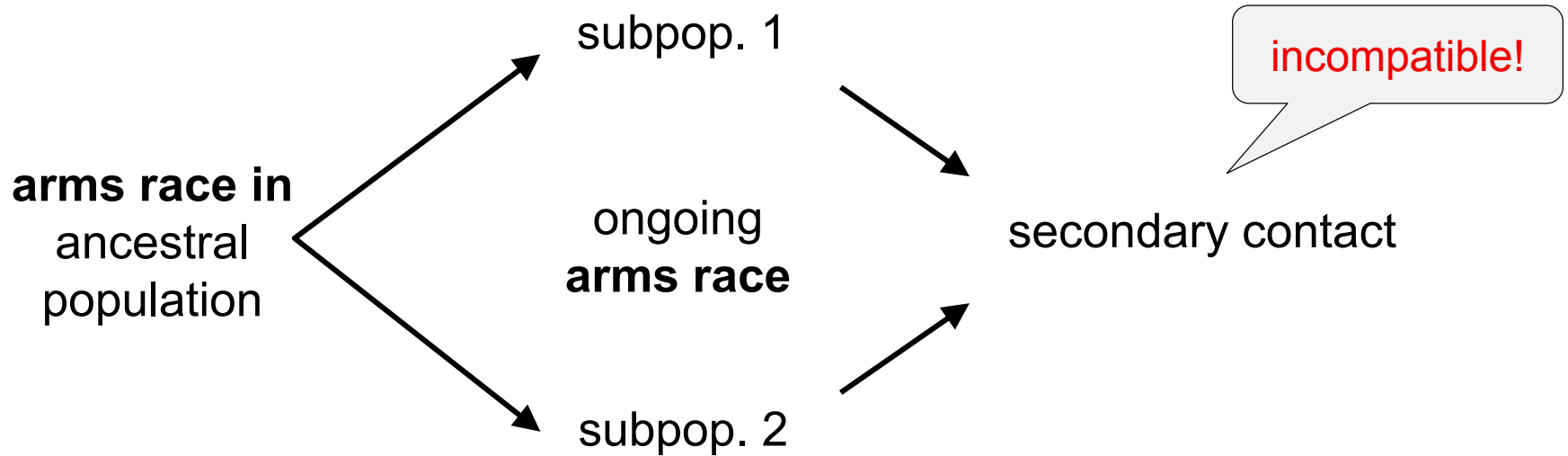

co-speciation (parasite-host):

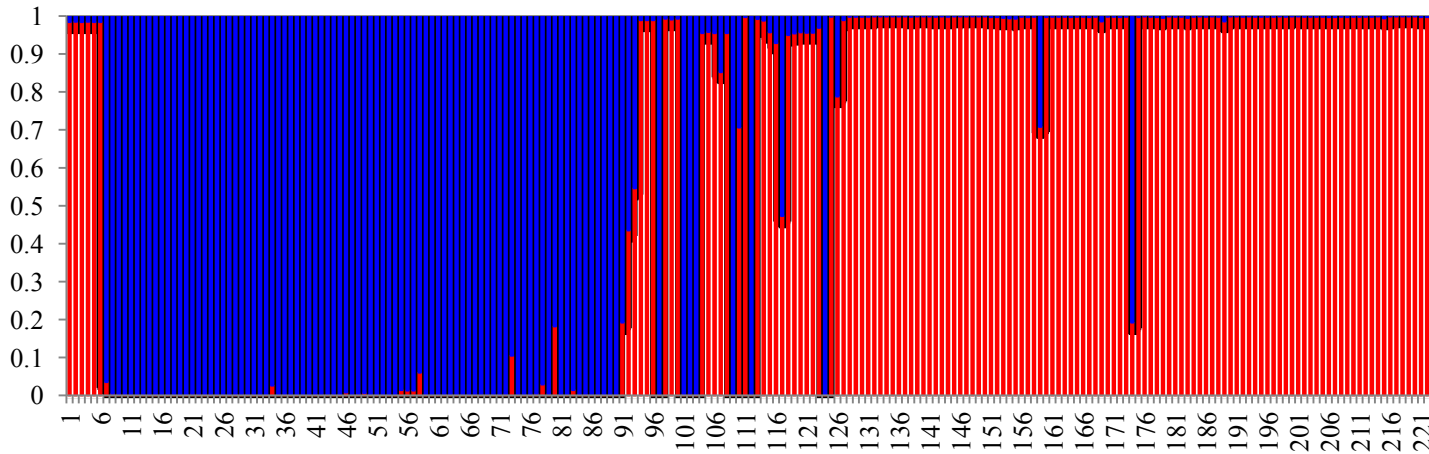
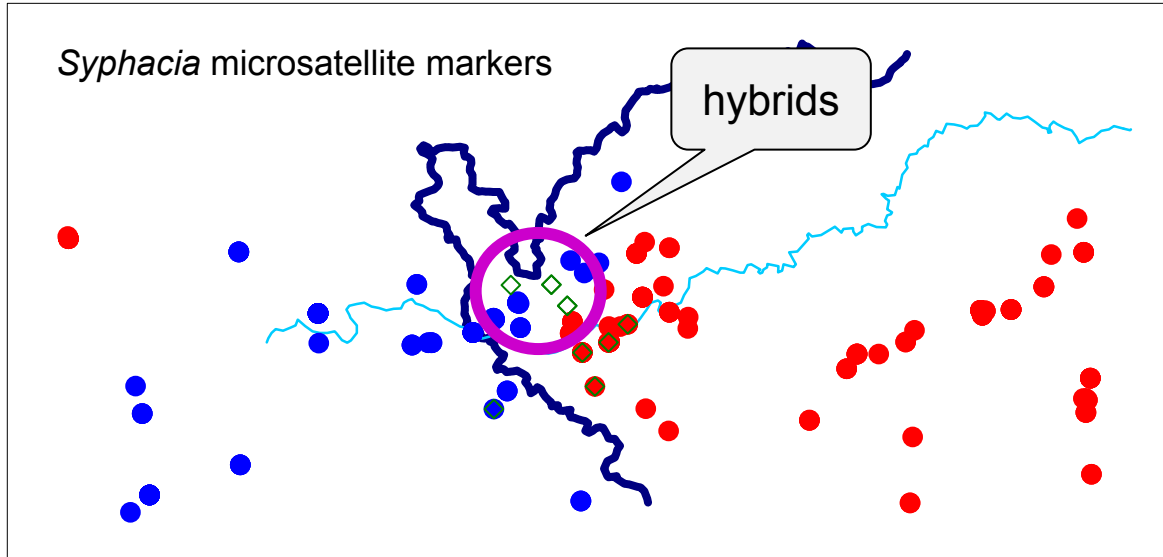

J. Goüy de Bellocq



Wasimuddin

Peripatric speciation (founder-effect speciation)

Mayr: founder effect

island organisms, peripheral isolates (extinction-recolonisation)

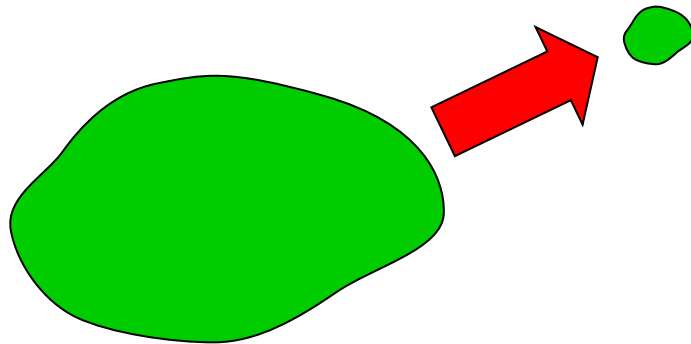

genetic revolution \Rightarrow rapid speciation

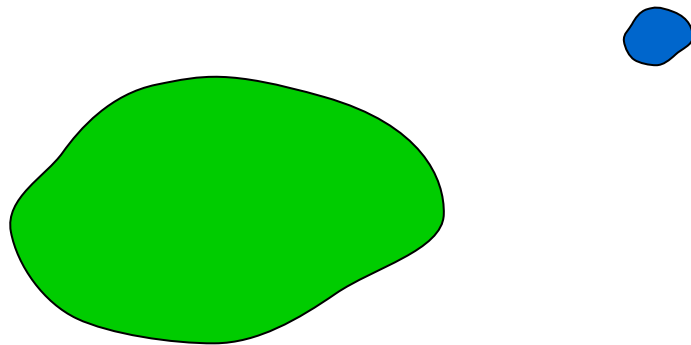

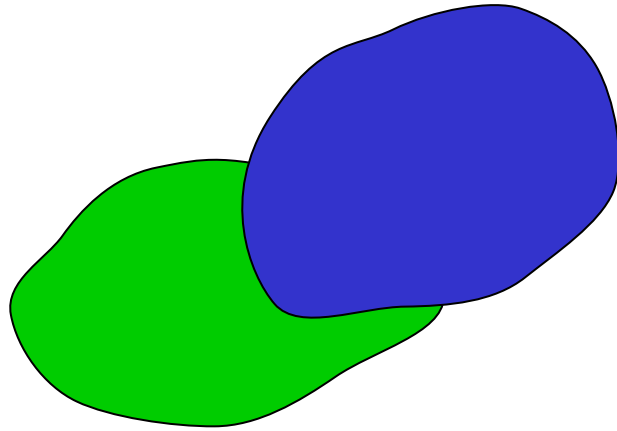

founder-flush model: *Drosophila*

colonisation of a novel environment – no selection \Rightarrow rapid divergence

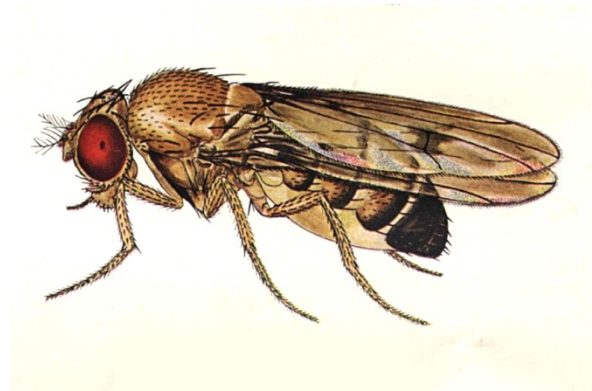
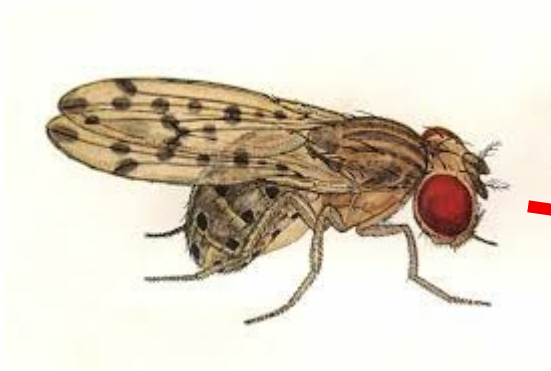

Allo-parapatric speciation (reinforcement speciation)

A. R. Wallace, R. A. Fisher, T. Dobzhansky

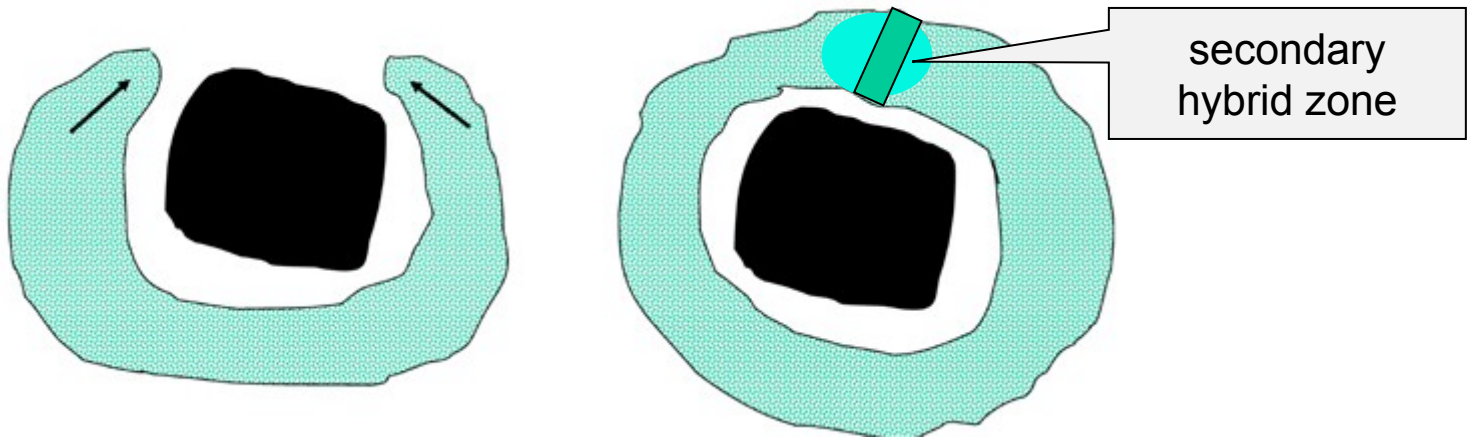

initial geographic isolation

reproductive isolation incomplete → secondary hybrid zone

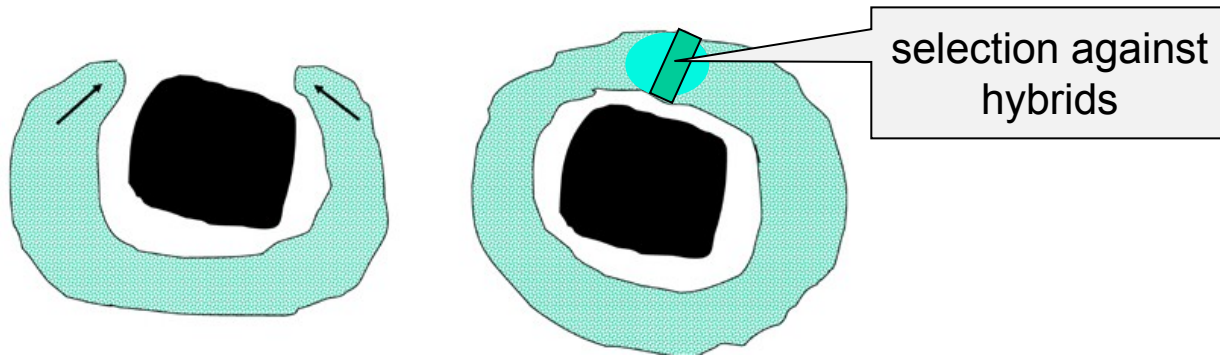

selection against hybrids \Rightarrow formation of prezygotic barrier
 \rightarrow strengthening of isolation (**reinforcement**) = Wallace's effect

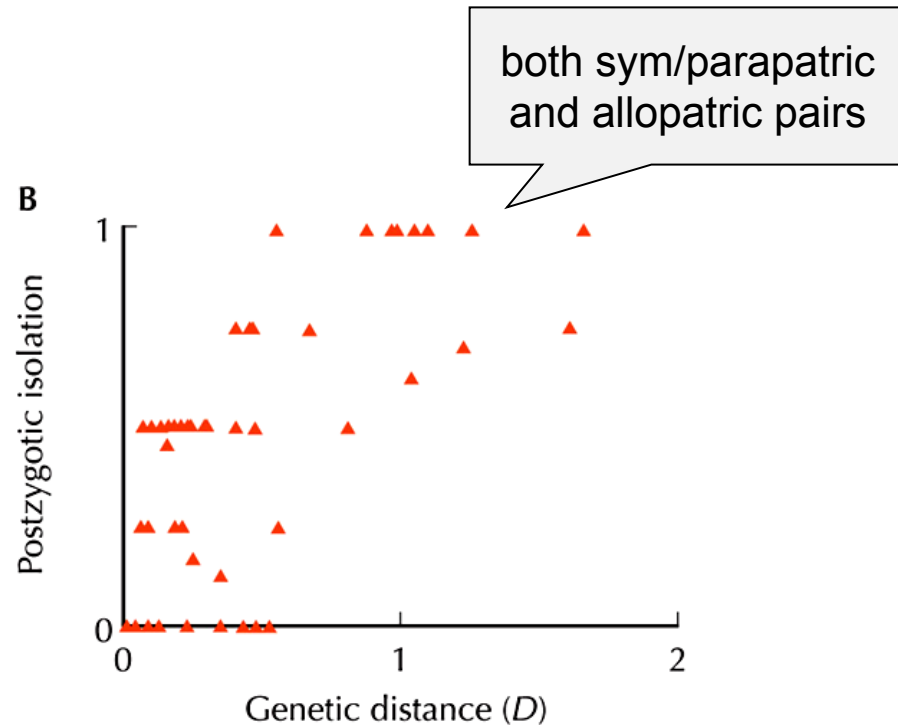
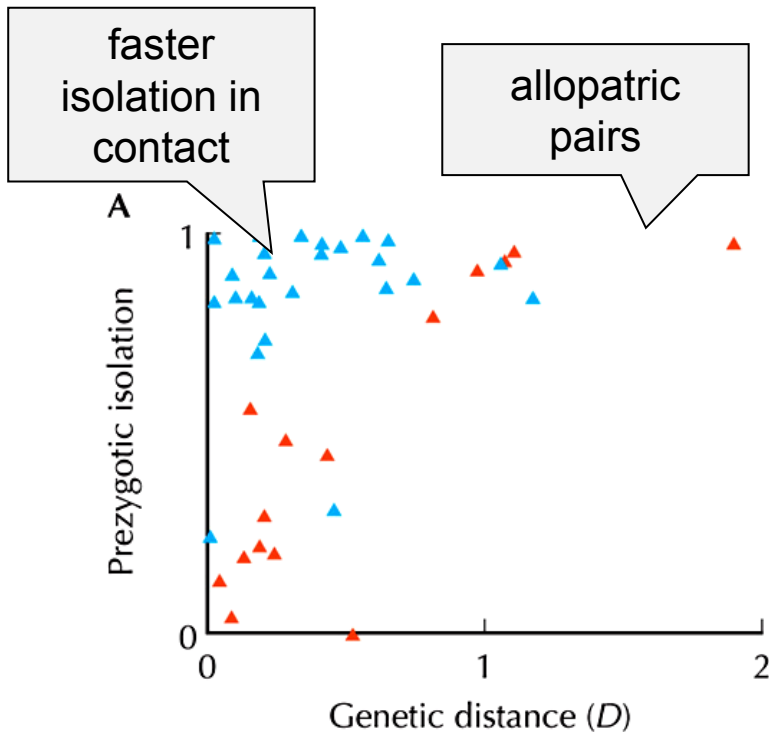

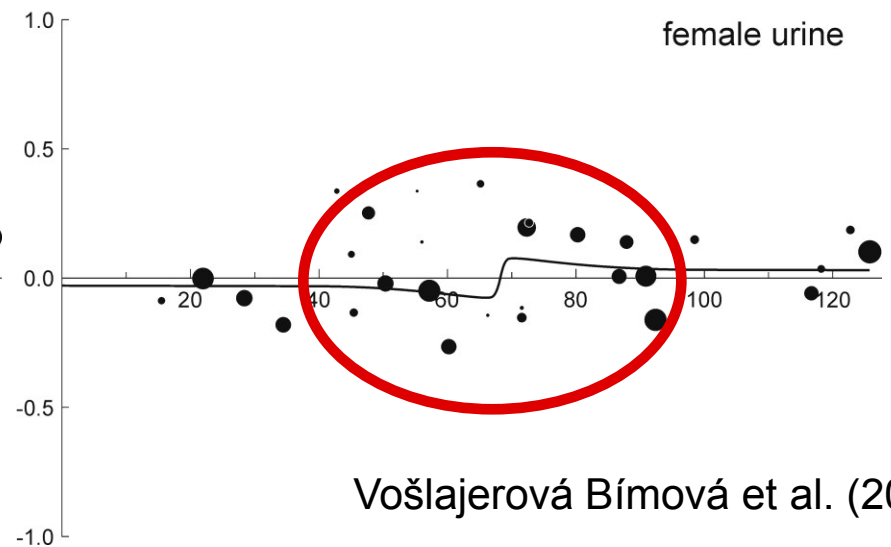
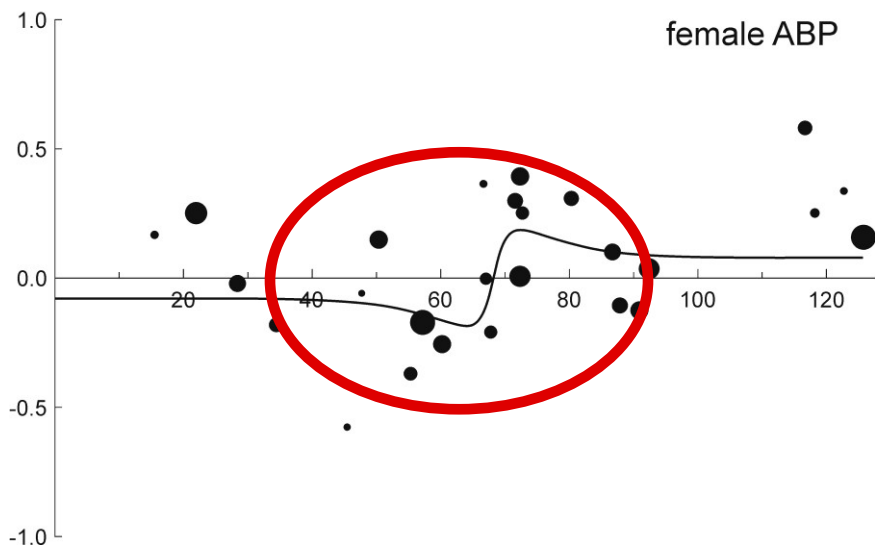
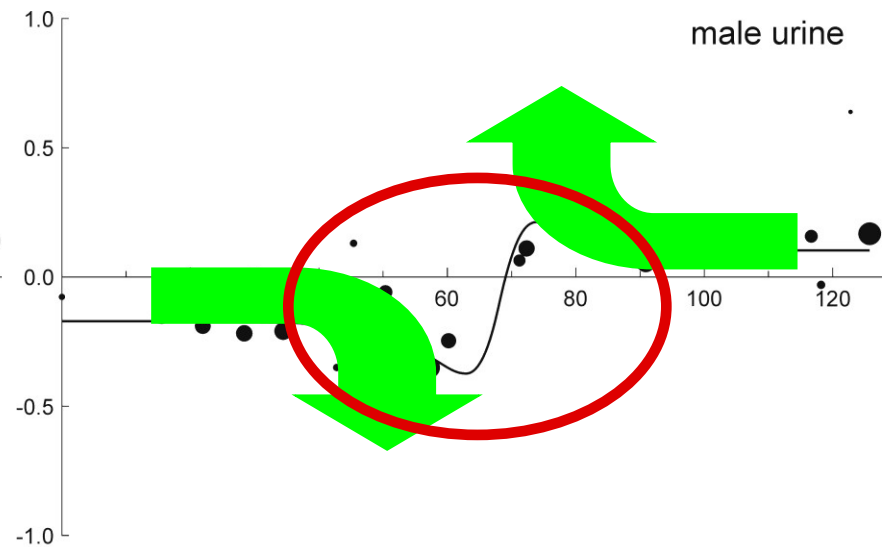
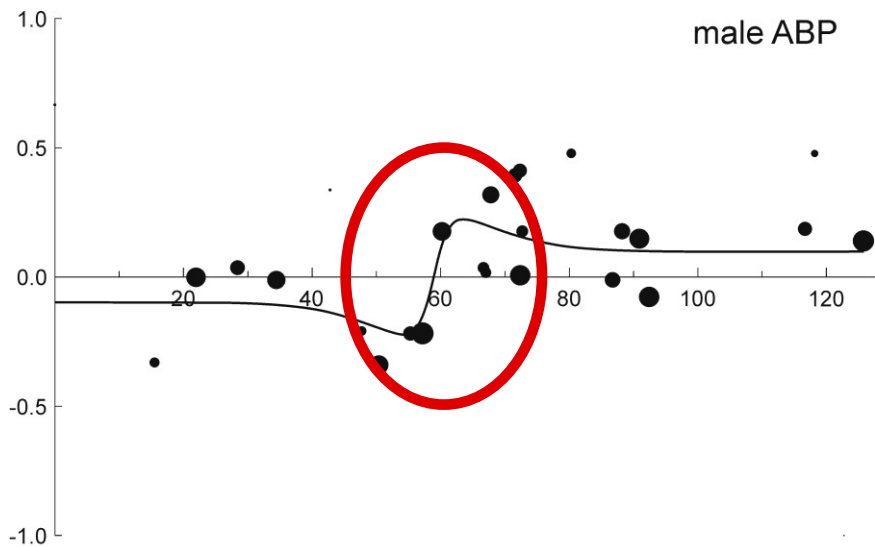

Vošlajerová Bímová et al. (2011)

Both female and male preference show **reinforcement** in the zone centre \Rightarrow prezygotic barrier probably contributes to reproductive isolation

Parapatric speciation

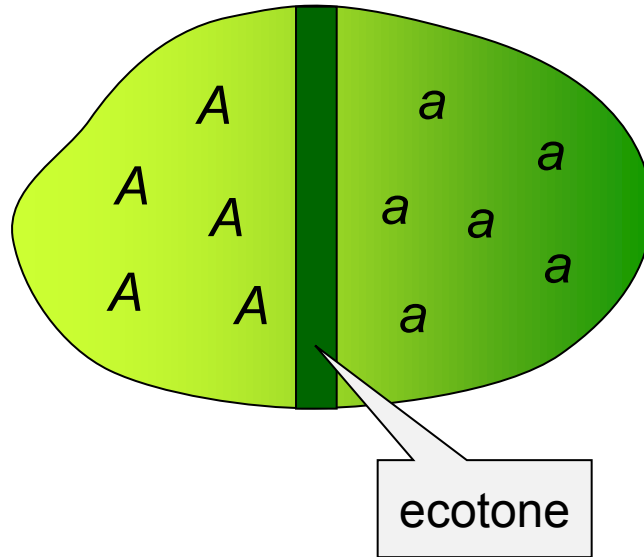

environmental gradient \Rightarrow genetic gradient

\Rightarrow primary hybrid zone

different selection in the two parts \Rightarrow genetic divergence even with gene flow

Sometimes difficult to distinguish allopatric and parapatric speciation:

ring species

Speciation by 'circular overlap'

a

species spreading around
uninhabitable area

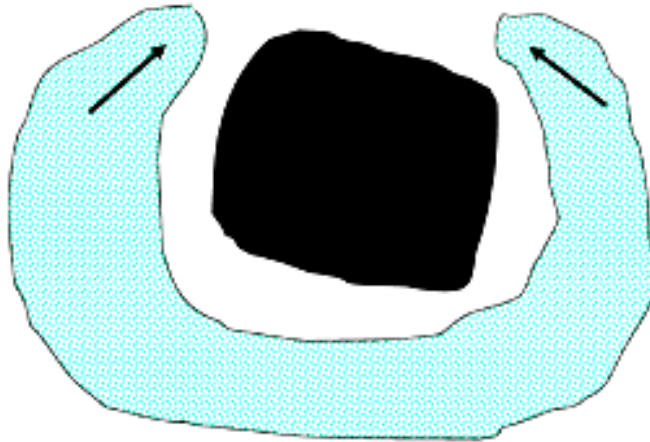

b

'circular overlap' shows
reproductive isolation

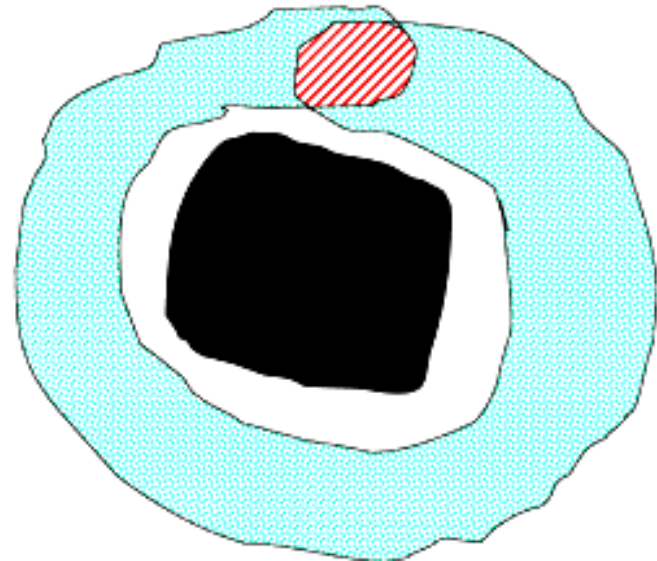

ring species:

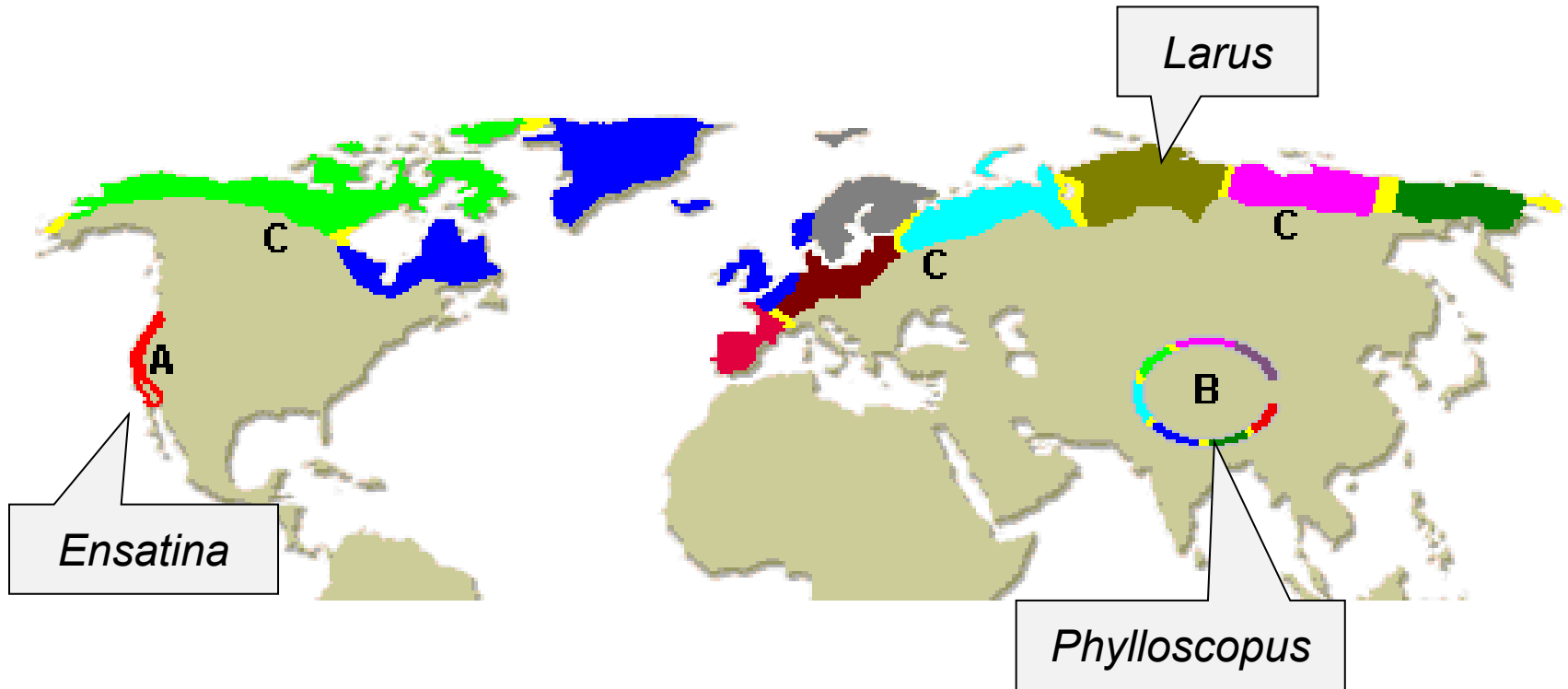

ring species:

European herring gull (*Larus argentatus*) and lesser black-backed gull (*L. fuscus*)

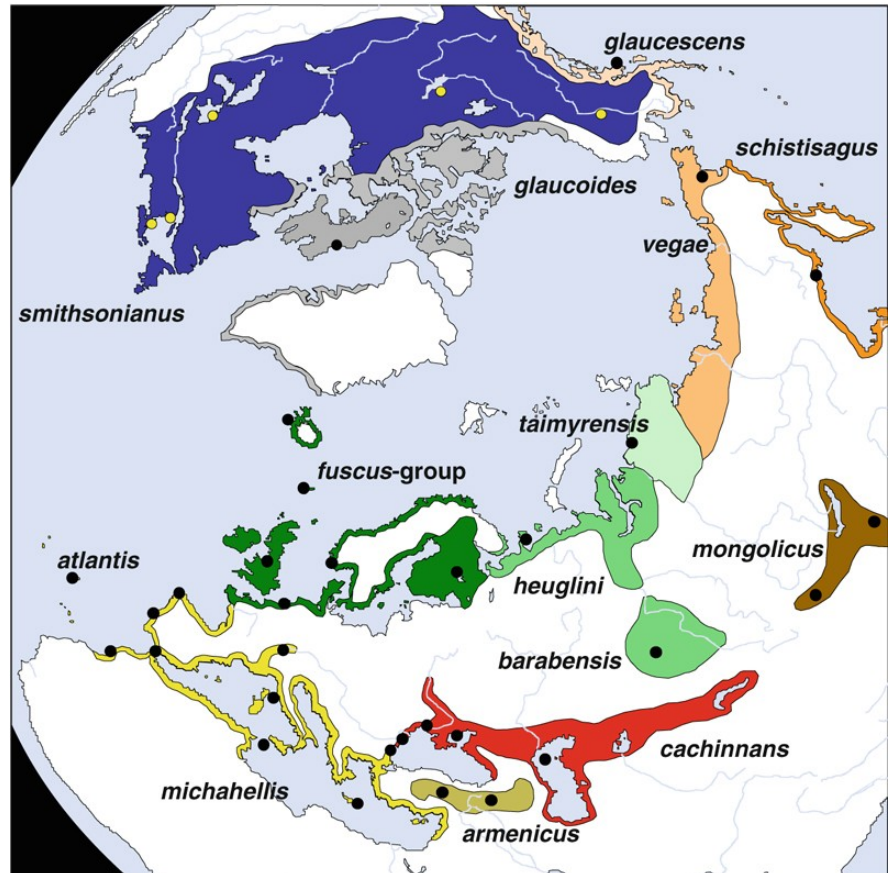
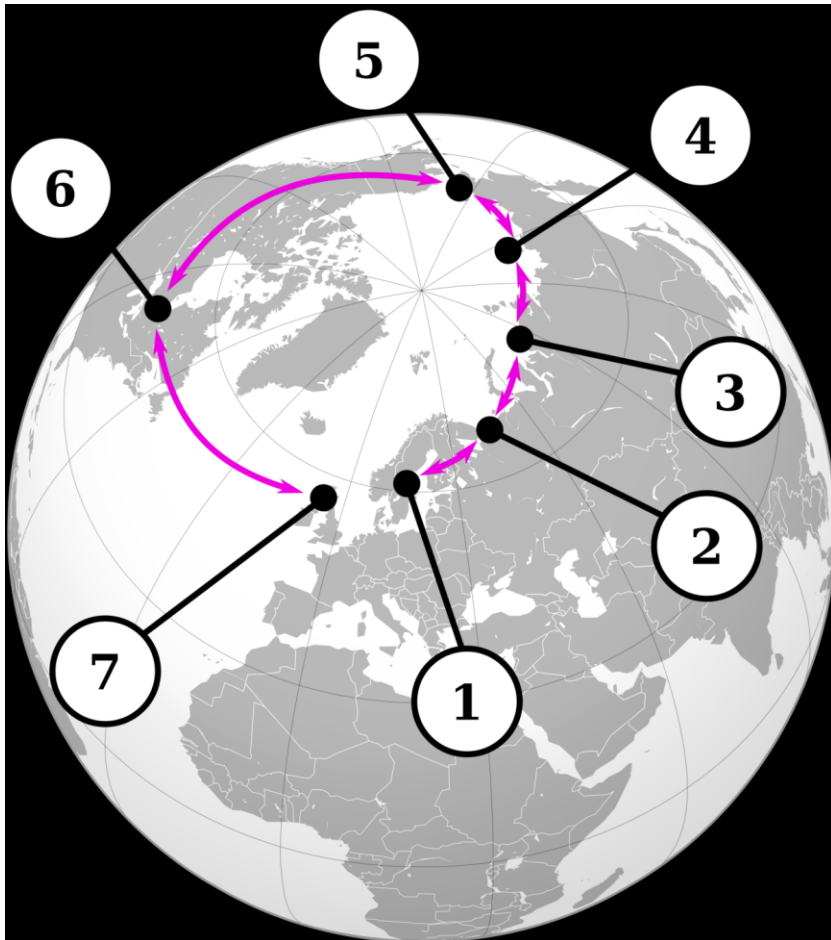

ring species:

greenish warbler (*Phylloscopus trochiloides*)

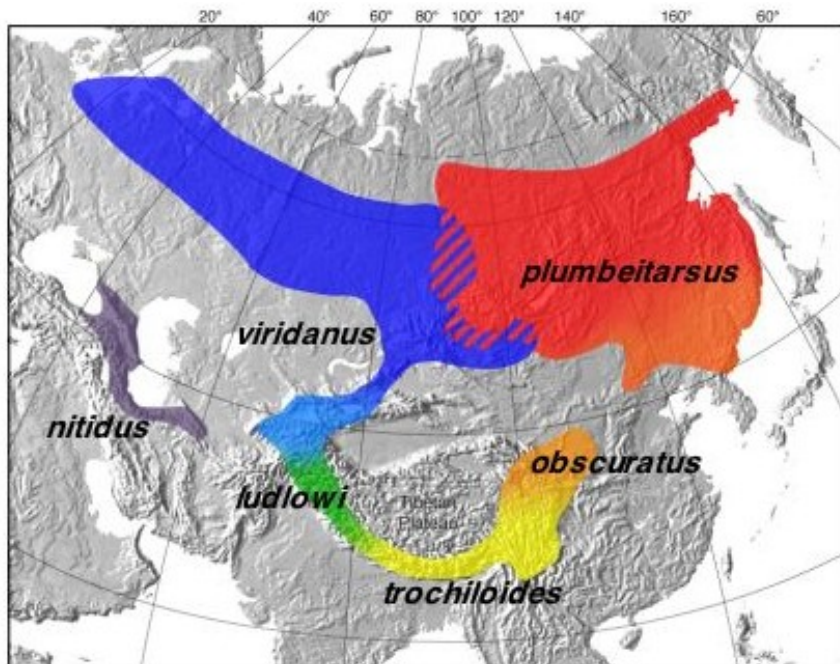

Tracing the Evolution of Species

Biologists have discovered two populations of Eurasian songbirds in Siberia that show the strongest evidence yet of having evolved from a single ancestral species into two distinct ones. The map below shows the present ranges of the birds around the Tibetan Plateau, with gradations of color indicating where gradual changes have evolved between one subspecies and another.



Singing a new song

Sound spectrograms show how the warblers' songs at various locations on the map (A through H) become more complex until, where the two populations occupy the same range (at E and H), they can no longer recognize each others' songs.

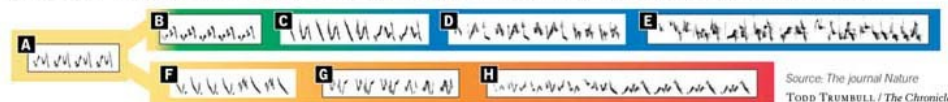

Source: The journal Nature
TODD TRUMBULL / The Chronicle

ring species:



Ensatina e. xanthoptica



Ensatina e. klauberi

Ensatina eschscholtzii

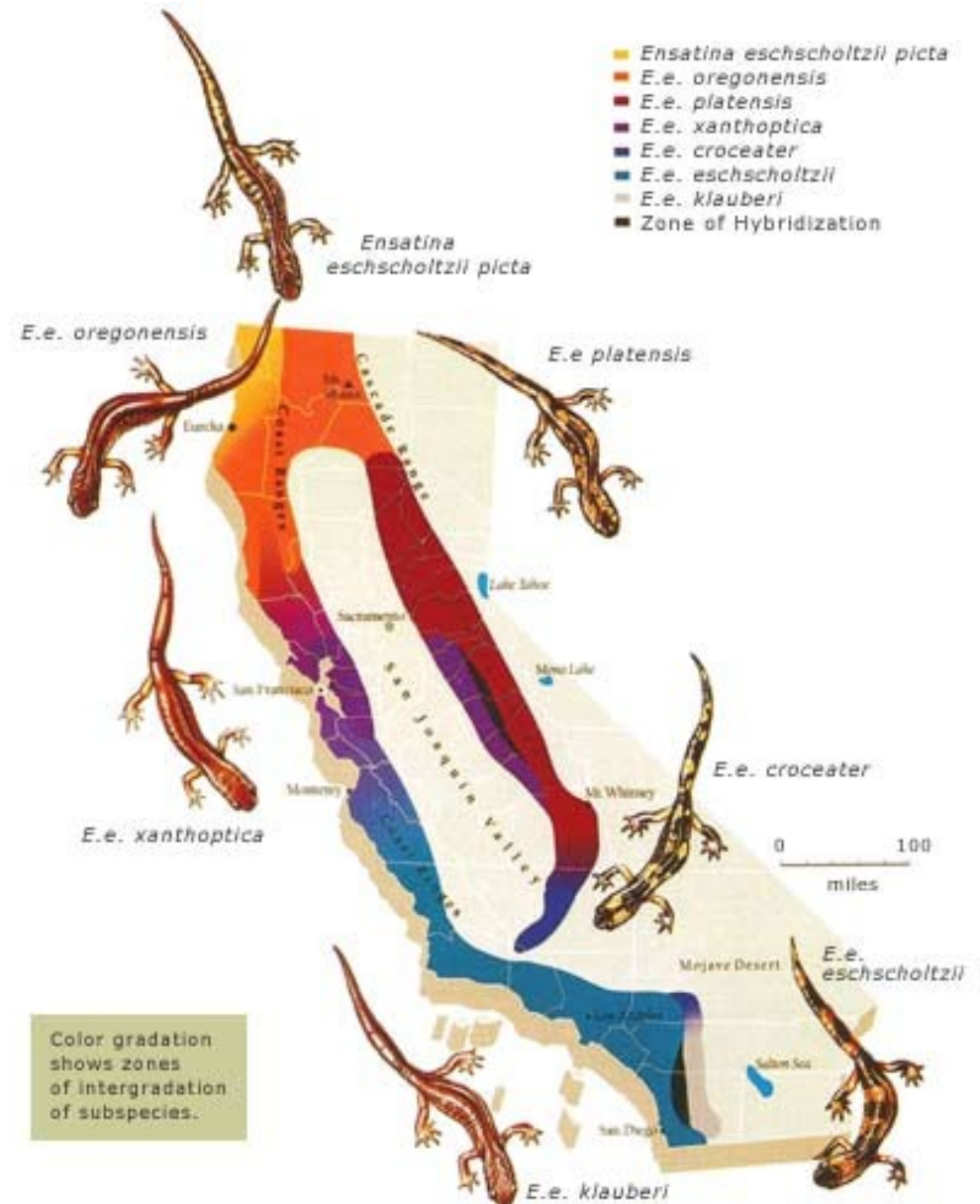

Sympatric speciation

Polyploidisation

$$2N \rightarrow 4N$$

$$2N \times 4N = 3N$$

aneuploid
hybrids

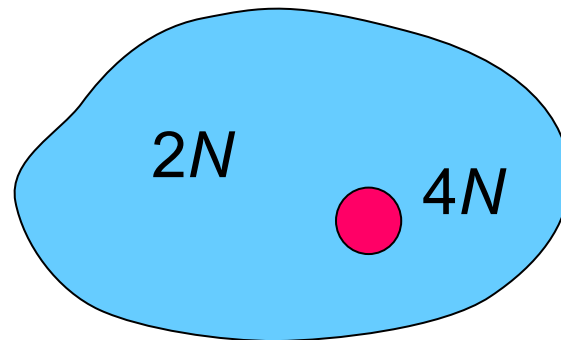

Arabidopsis thaliana × *A. arenosa* → *A. suecica*



Sympatric speciation

Host shift

apple magot (*Rhagoletis pomonella*):

hawthorn → 1866 apple → ca. 1960 cherry tree

pear, rose, plum etc.

assortative mating, genetic differences, different incubation period
(seasonal isolation)

absence of postzygotic mechanisms



R. pomonella

Final overview:

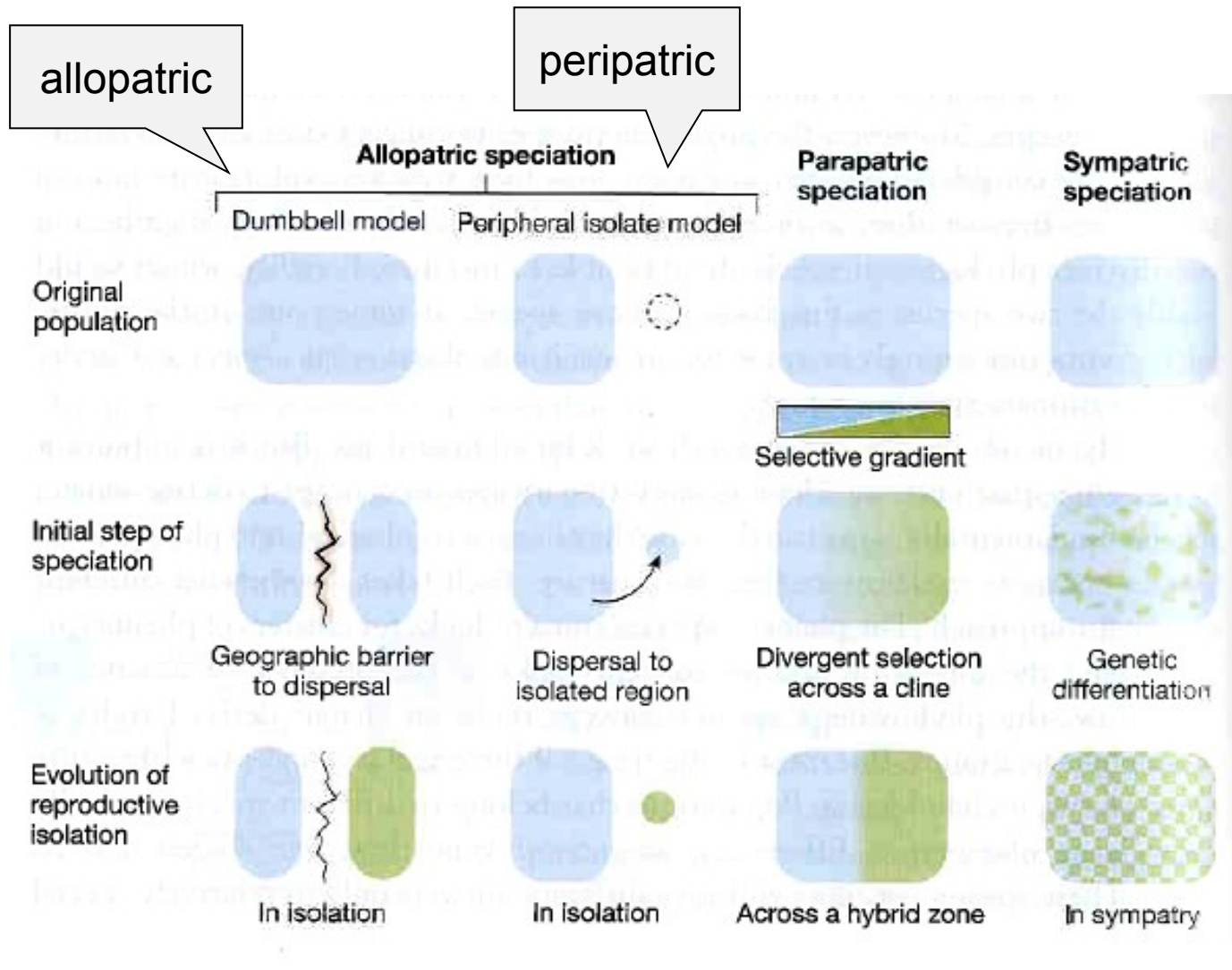

Rate of speciation:

allopatric speciation usually slow

rapid speciation and adaptive radiation:

Darwin's finches

fruit flies in Hawaii

cichlids in African lakes

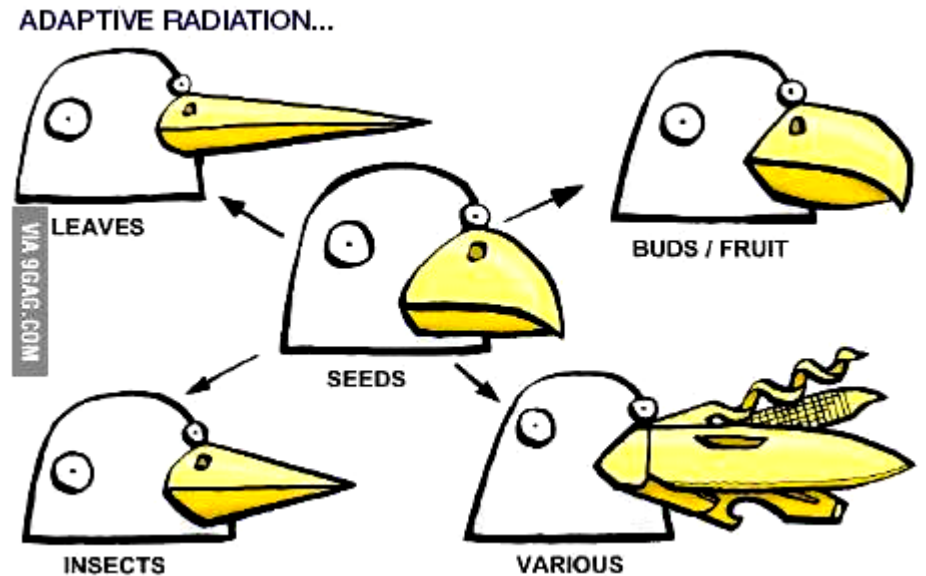

Great Rift Valley – Viktoria, Malawi, Tanganyika;

Viktoria: 400 000 years, 17 300 – drying, 14 700 re-creation;
molecular clock: ancestor of cichlids – 100 000 years

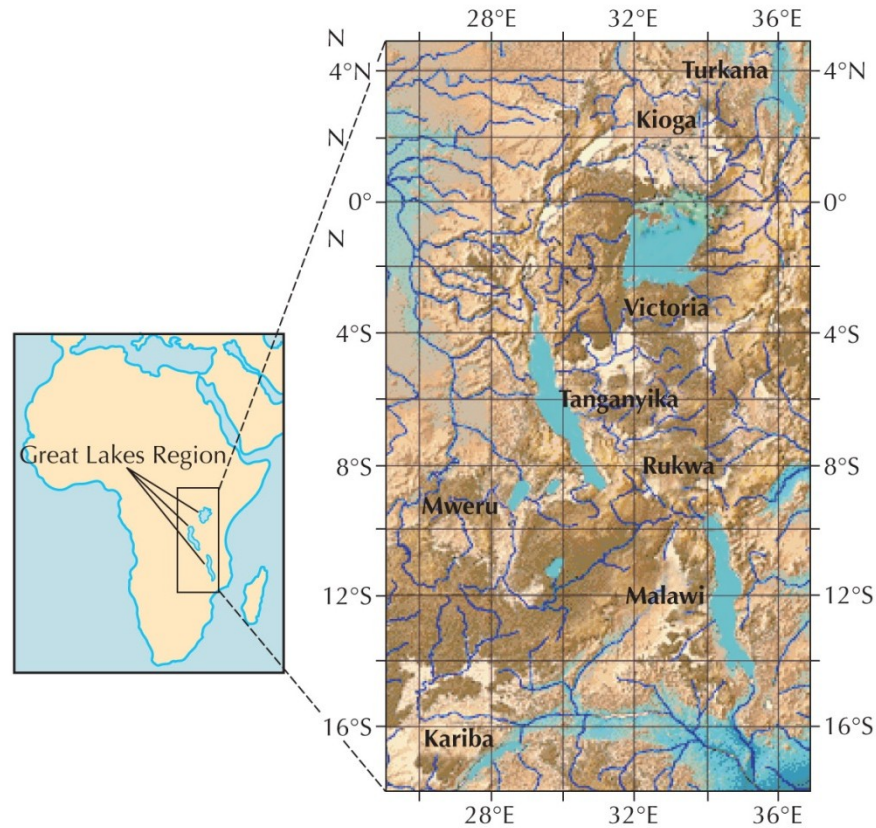

Cameroon: Barombi Mbo (4,2 km²) – 11 species, Bermin (0,6 km²) – 9 cichlid species, monophyletic origin, absolute isolation, ancestor – 10 000 years



Barombi Mbo



Bermin

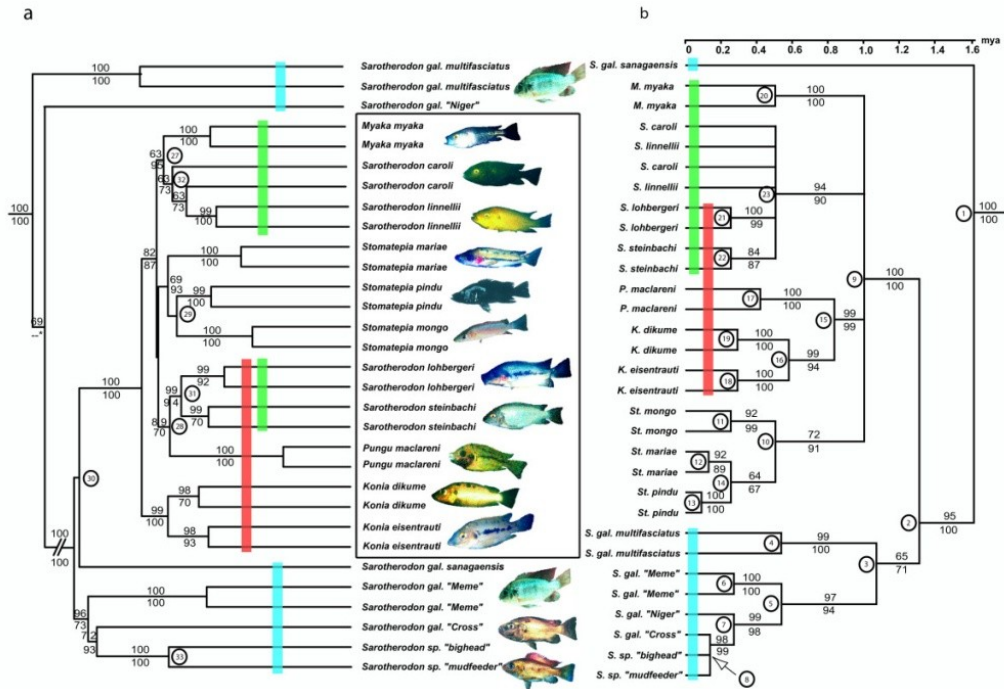

Parallel speciation

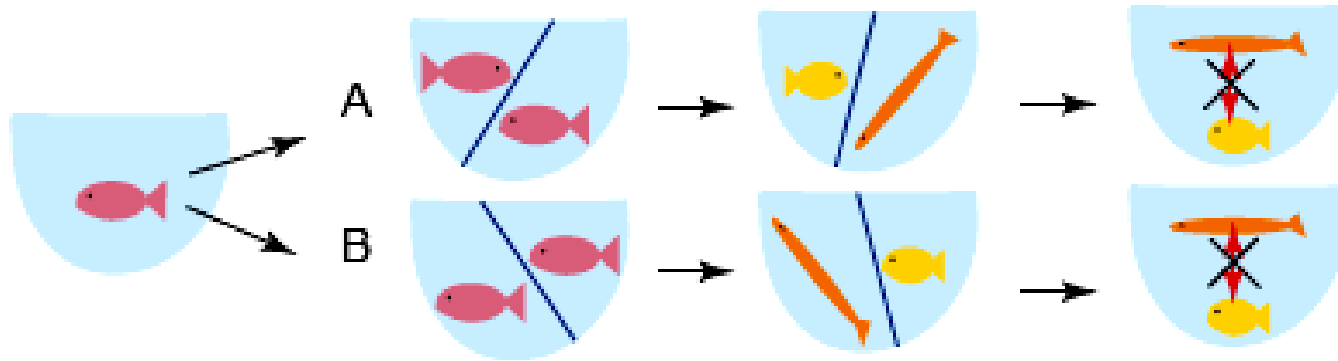

habitat shift

role of natural selection

role of sexual selection (cichlids)