

# C7790 Introduction to Molecular Modelling

## TSM Modelling Molecular Structures

### Lesson 2

#### Computational Chemistry vs Experiment

**PS/2021 Present Form of Teaching: Rev4**

Petr Kulhánek

[kulhanek@chemi.muni.cz](mailto:kulhanek@chemi.muni.cz)

National Centre for Biomolecular Research, Faculty of Science  
Masaryk University, Kamenice 5, CZ-62500 Brno

# Method overview (model chemistry)

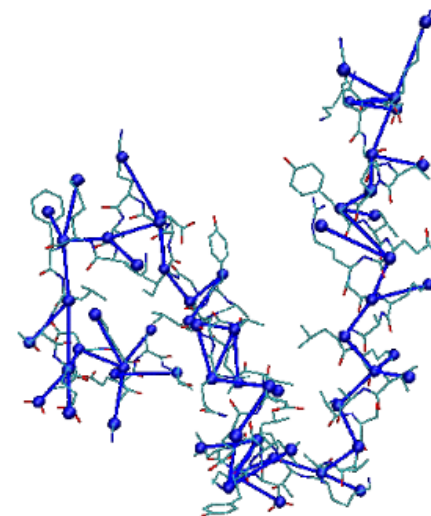
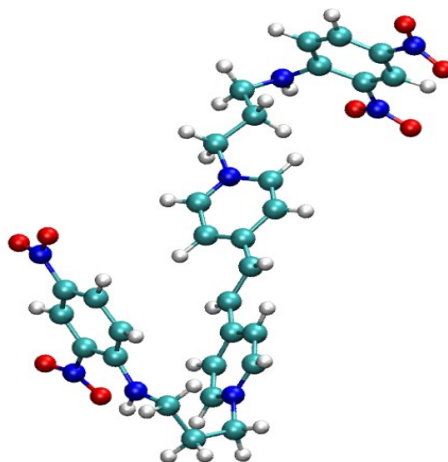
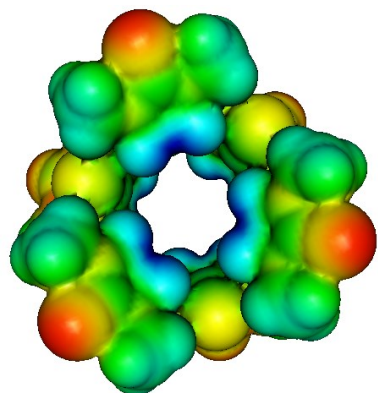

**Quantum mechanics**

**Molecular mechanics**

***Coarse-grained* mechanics**

atomic resolution

bead resolution

reactivity

conformational movements

domain movement, folding

up to 1,000 atoms \*

up to 1,000,000 atoms \*

up to 1,000,000 beads \*

up to 100 ps \*

to 1  $\mu$ s \*

up to ms \*

# Importance of computational chemistry

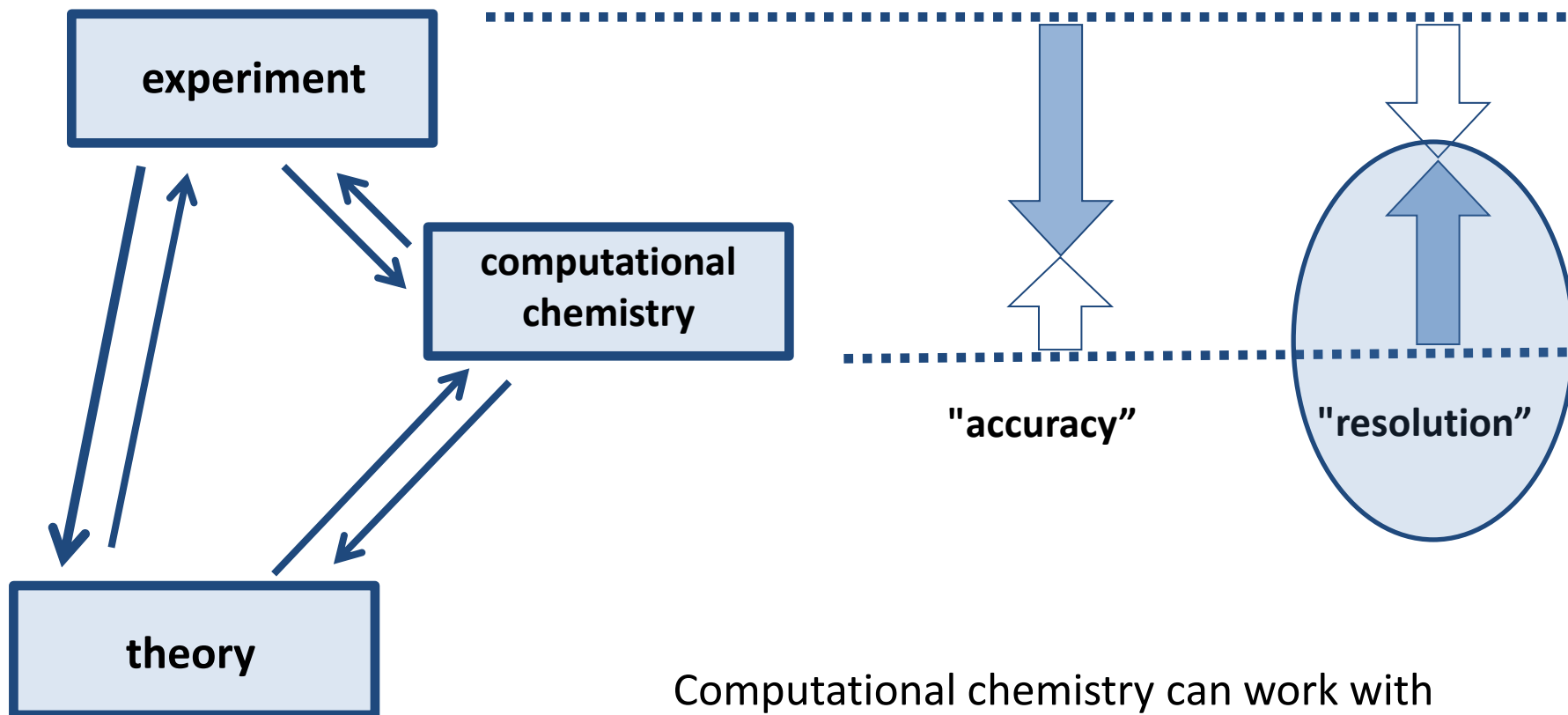

Computational chemistry can work with **single atom resolution**.

# Atomic resolution

## computational chemistry

atomic resolution since the introduction of quantum theory (1925)

- it refines models
- it improves calculation procedures
- it achieves more accurate results in less computational time

## experiment

atomic resolution since the introduction of X-ray crystallography (1923)

- it refines techniques
- it improves the resolution

Historical development



Experiments with single atom or molecule resolution.  
(Single Molecule Experiments)

# Atomic Resolution Experiments

# X-ray Crystallography

## X-ray diffraction on the crystal structure

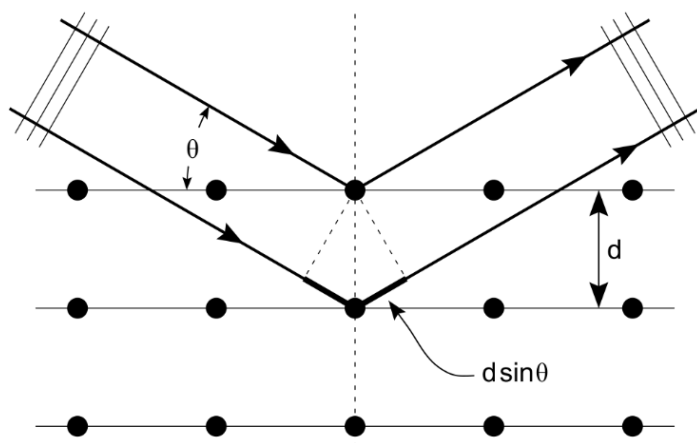

## Bragg's law:

$$2d \sin \theta = n\lambda$$

X-rays diffract on electrons from atoms.

## Disadvantages:

- the sample must be a monocrystal
- radiation damage

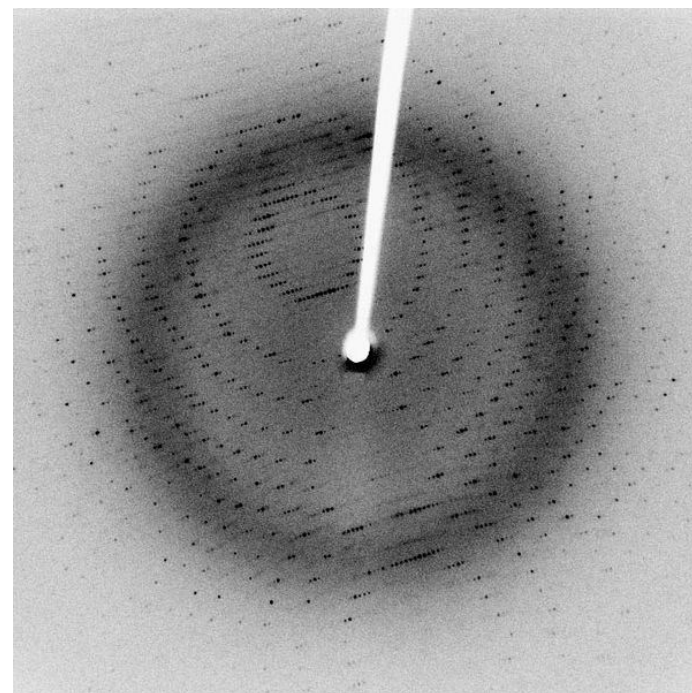

Diffraction pattern (enzyme crystal)

<http://www.wikipedia.org>

# X-ray Crystallography

X-ray crystallography method determines the position of individual atoms in the unit cell of crystal.

**However, the positions of some atoms may not be determined** in the case of low resolution or internal disorder. This usually happens for hydrogen atoms (weakly diffracting), side chains in biomolecules, or weakly bound substrates.

Diffraction on crystals can be achieved with other sources of beams with suitable wavelengths:

- **Neutrons** - Benefit of **neutron diffraction** is that the diffraction occurs at the nuclei of individual atoms. This method can determine hydrogen atom positions, because protons (hydrogen atom nuclei) diffracts very well.
- **Electrons** - electron crystallography, available in modern electron microscopes

# Nuclear Magnetic Resonance - NMR

- chemical shift
- J-coupling
- NOE (Nuclear Overhauser Effect) - proportional to the distance
- and more

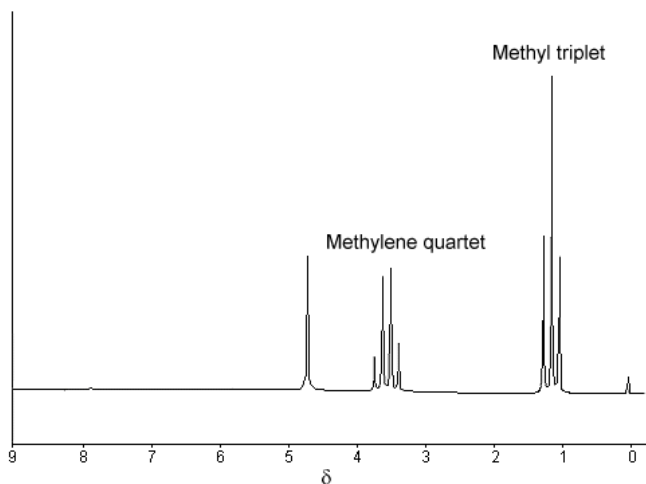

## Advantages:

- sample in solution
- non-destructive

## Disadvantages:

- isotope labeling
- not suitable for very large molecules

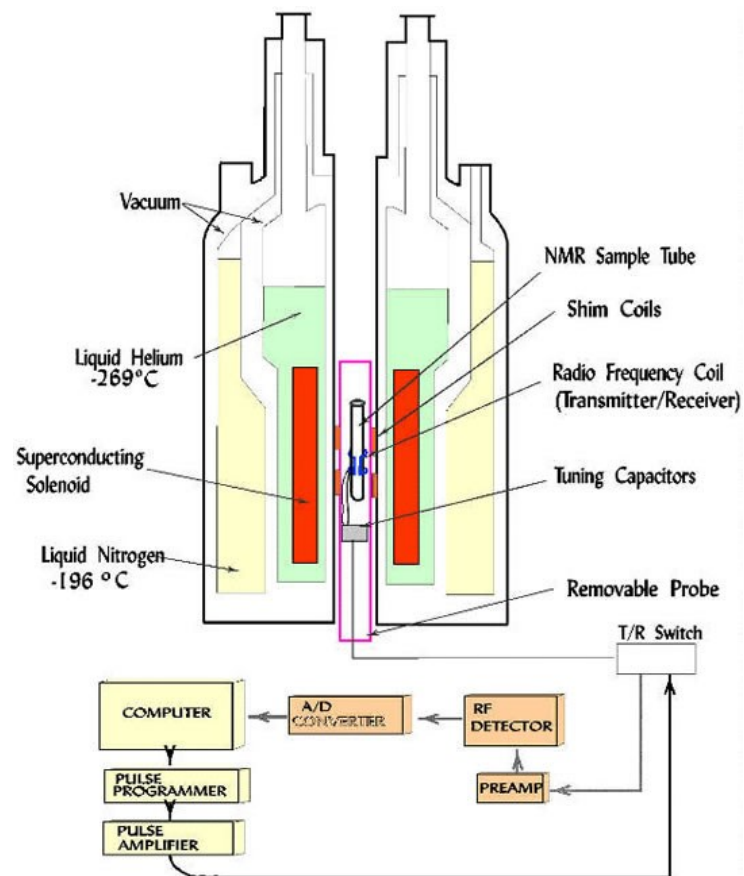



# Nuclear Magnetic Resonance - NMR

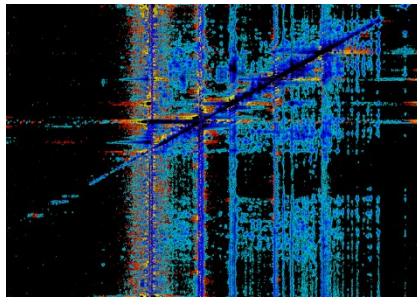

NMR spectra

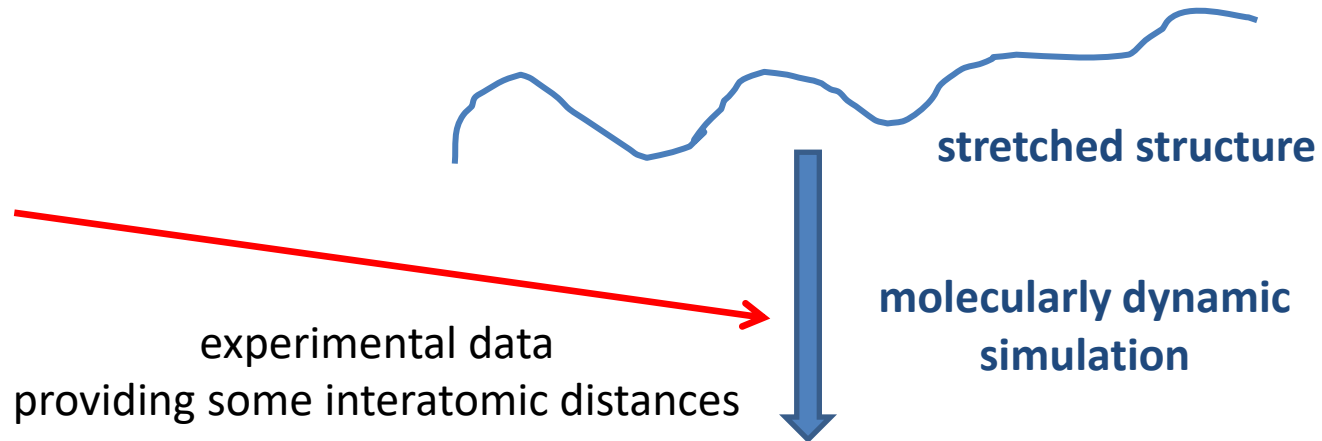

the resulting structure is represented by  
several conformations

the structure contains hydrogen atoms, which  
are provided by used theoretical model  
(molecular mechanics)



Macek, P .; Hops, J .; Cross, I .; Savoy cabbage, P .; Padrta, P .; Žídek, L .; Wild, M .; Hadravová, R .; Chaloupková, R .; Pichová, I .; et al. NMR Structure of the N-Terminal Domain of Capsid Protein from the Mason – Pfizer Monkey Virus. *Journal of Molecular Biology* **2009**, 392, 100–114.

# Scanning Tunneling Microscopy STM

## Principle:

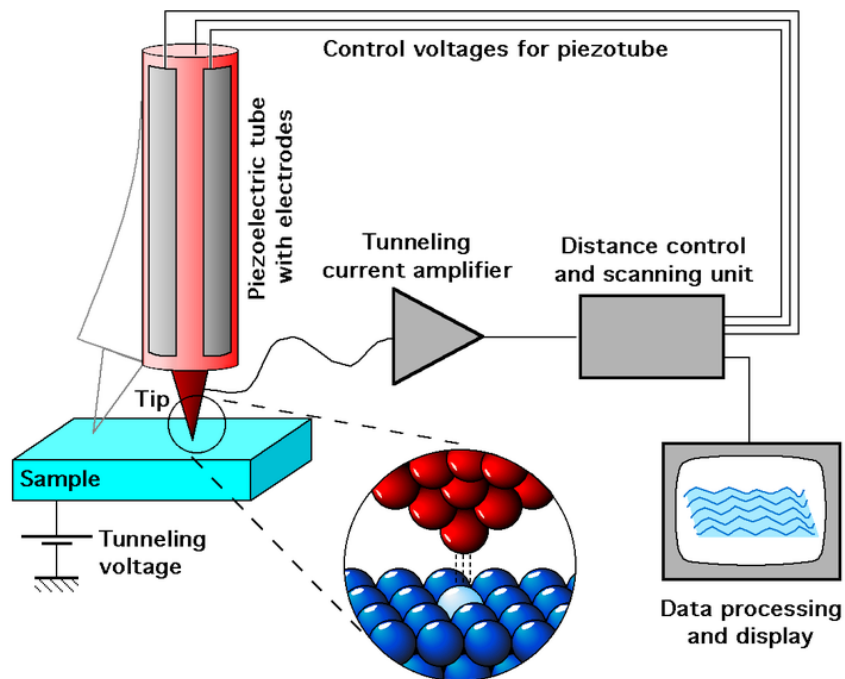

## Result:

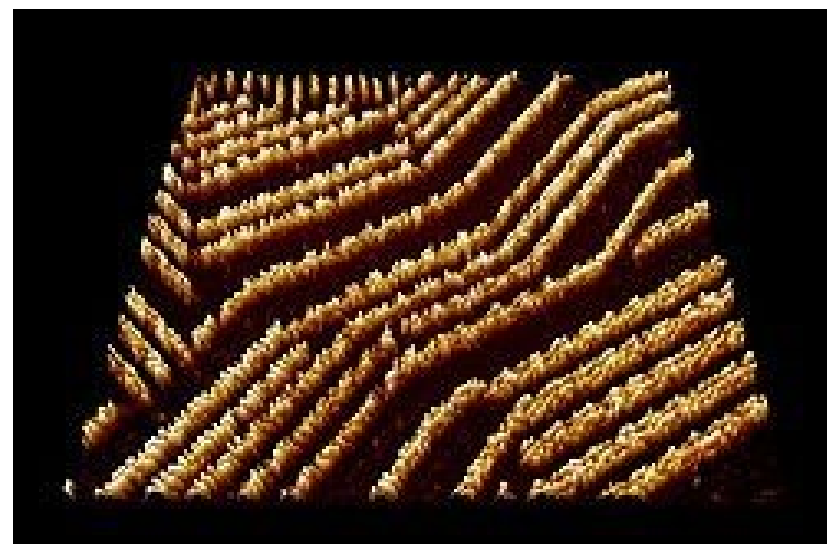

## Disadvantages:

- electroconductive materials

<http://www.wikipedia.org>

# Single Molecule Experiments

# Atomic Force Microscopy - AFM

## Principle:

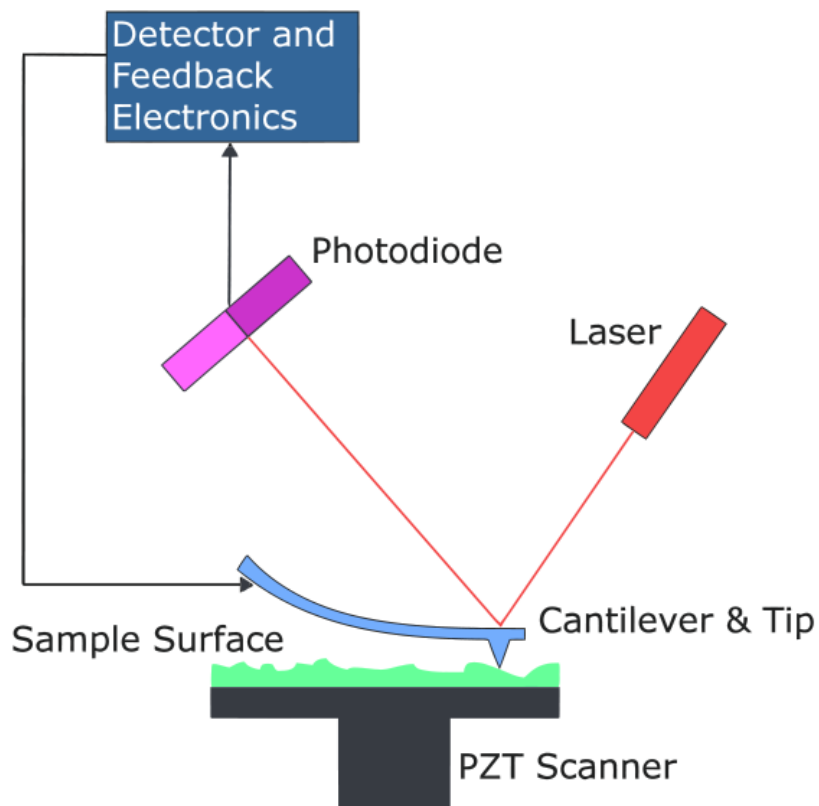

## Result:

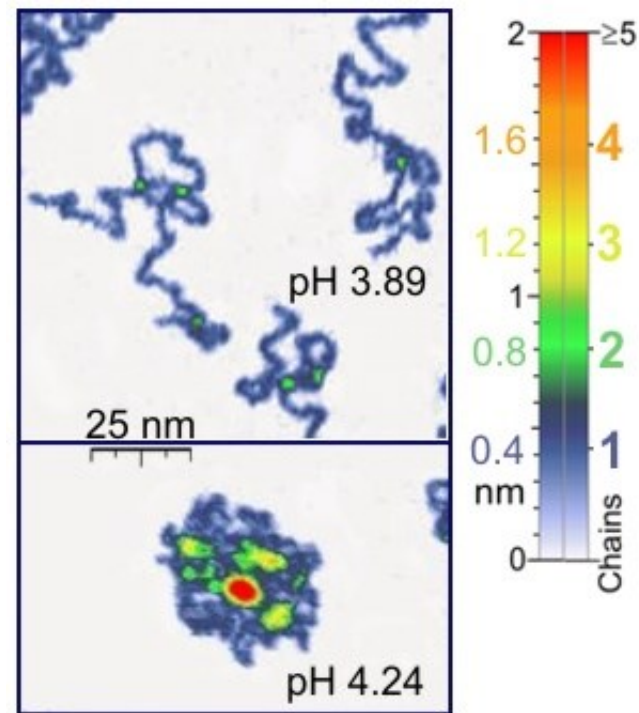

<http://www.wikipedia.org>

# FRET Experiments

## FRET: Fluorescent Resonance Energy Transfer

### Principle:

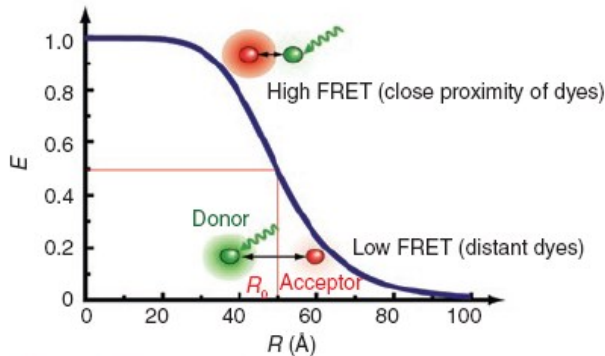

### Result:

$$E = \frac{1}{1 + (R / R_0)^6}$$

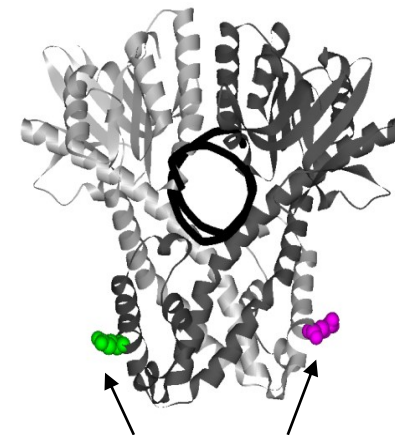
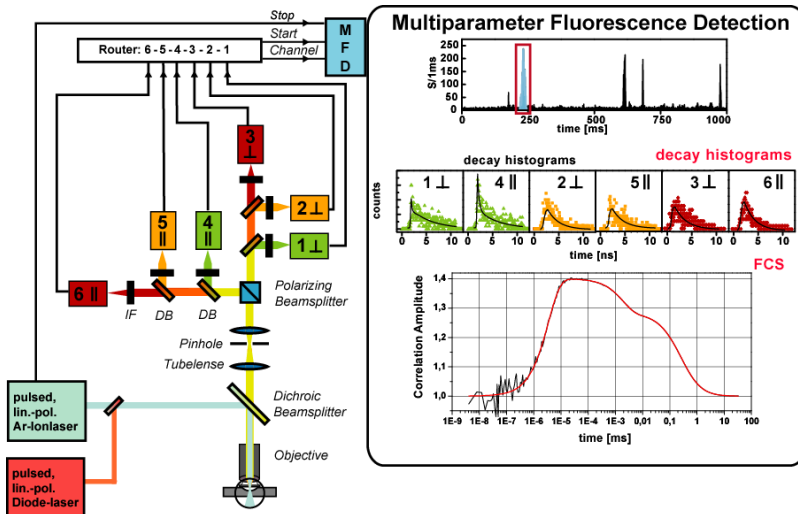

two chromophores  
we can determine the distance

### BsoBI

Q: Is it opened during DNA binding and if so, on which side?

# Magnetic and Optical Tweezers

## Principle:

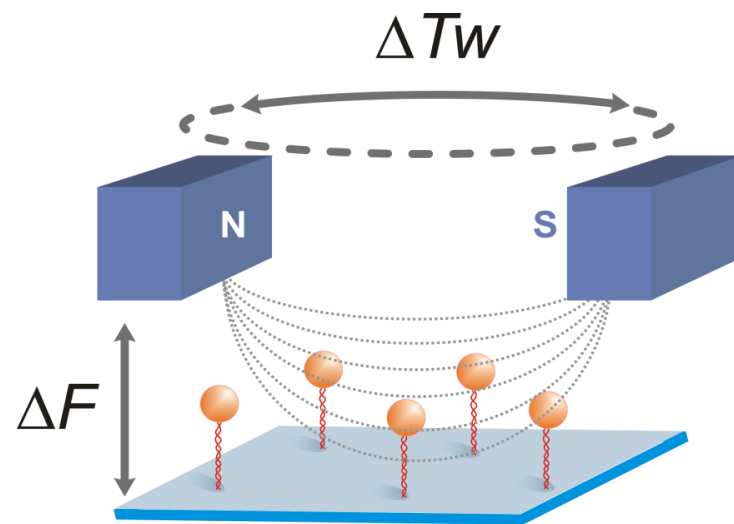
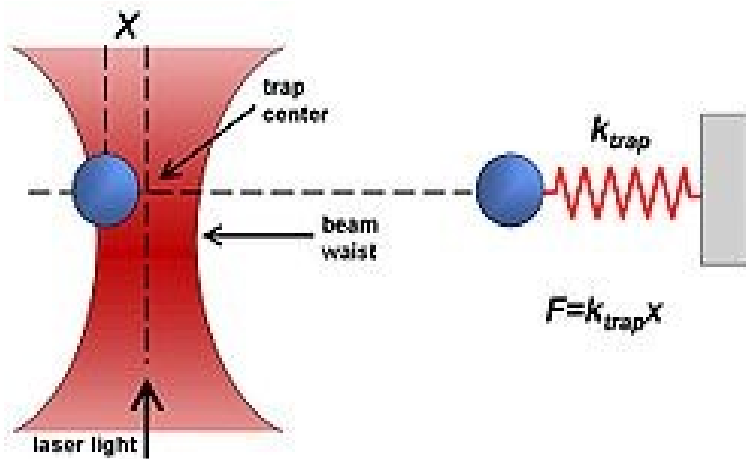

## Suitable for:

- Active/Binding site location
- Kinetics measurements

<http://www.wikipedia.org>

# Optical tweezers - use

VU University, Amsterdam



# Electron cryomicroscopy - cryoEM

**Electron microscopy** is a form of transmission electron microscopy where a sample is studied at low temperatures (typically liquid nitrogen temperature). The technique is used in structural biology.



Acceleration voltage: 300 kV

Building E35/ CEITEC

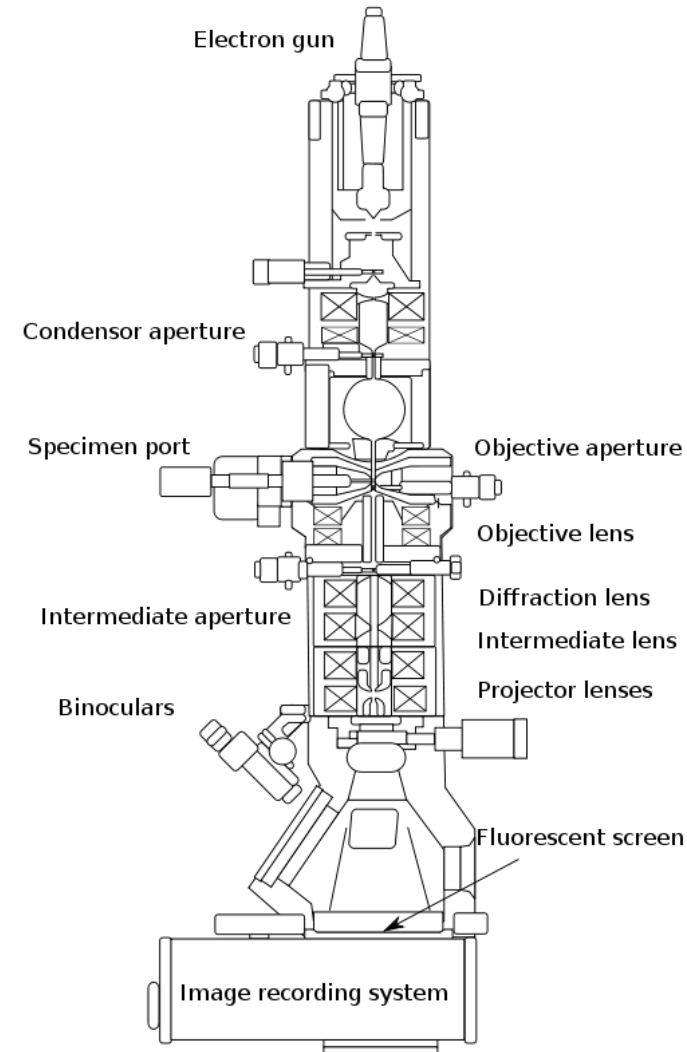



# Electron cryomicroscopy - cryoEM

## Pipeline in Biological Cryo-EM

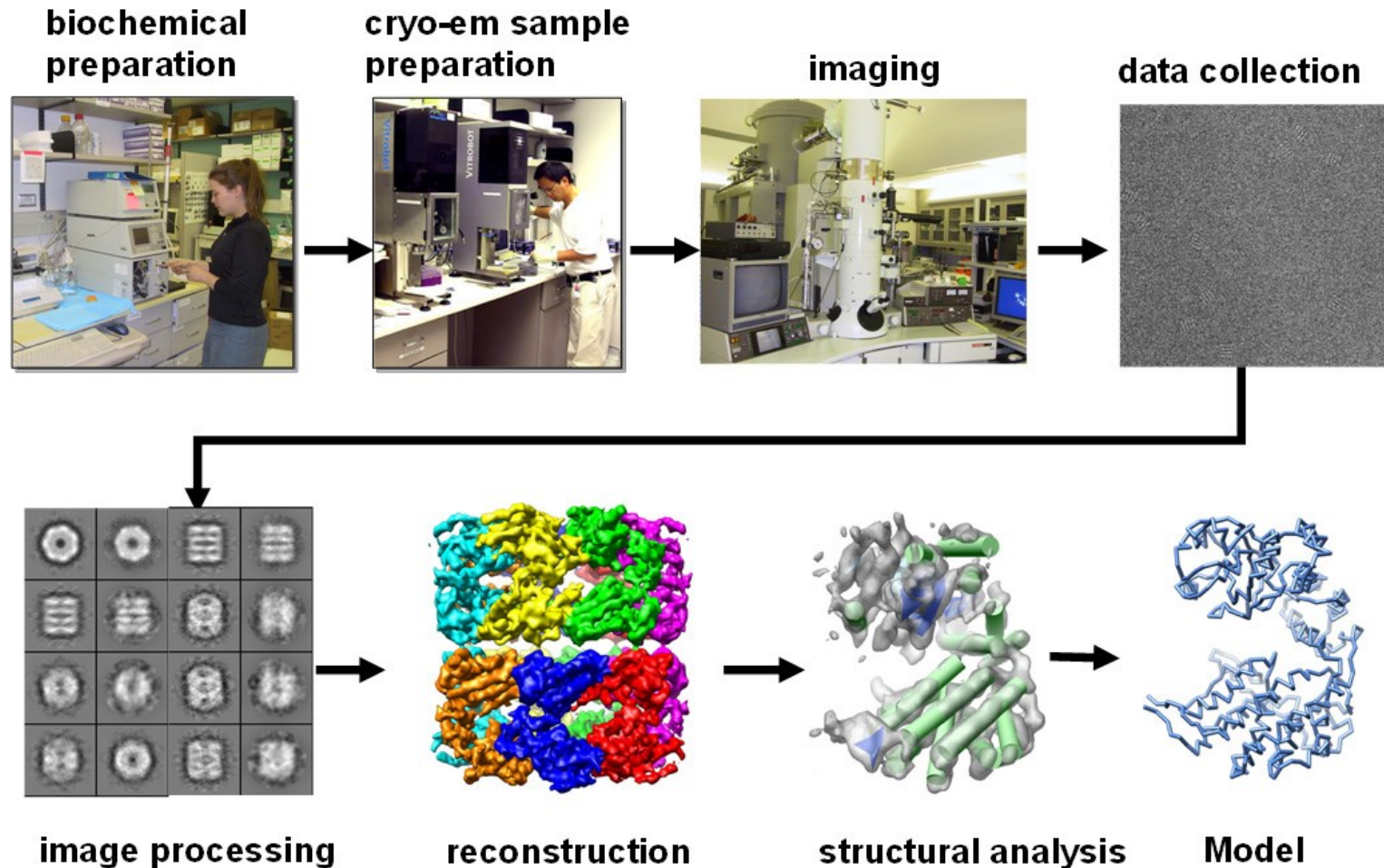

<http://proj.ncku.edu.tw/research/commentary/e/20080919/2.html>

# Small-angle X-ray scattering SAXS

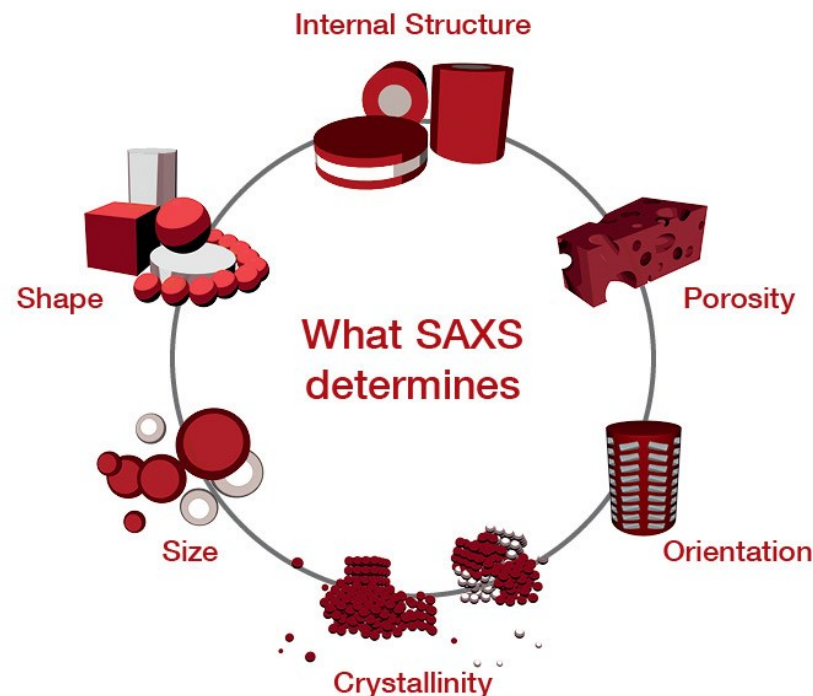
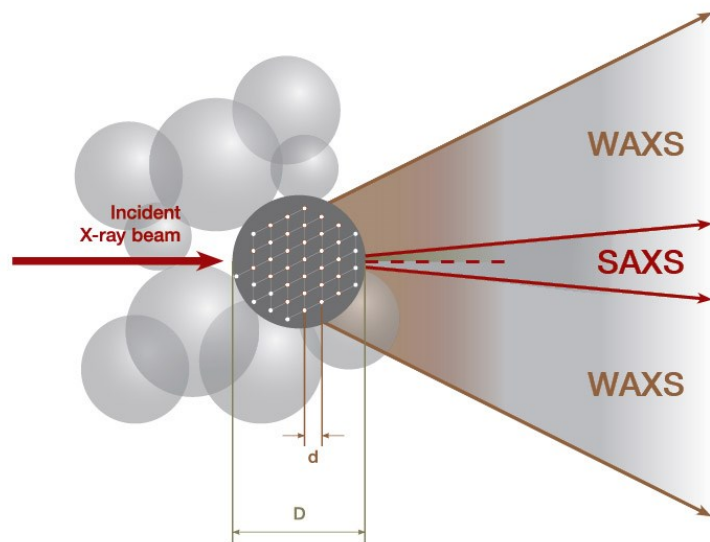

**Small-angle X-ray scattering (SAXS)** is a technique by which nanoscale density differences in a sample can be quantified.

It can determine nanoparticle size distributions, resolve the size and shape of (monodisperse) macromolecules, determine pore sizes, characteristic distances of partially ordered materials, and much more.

<https://wiki.anton-paar.com>

# Structure Databases

## Cambridge Structural Database (CSD)

<http://www.ccdc.cam.ac.uk/Solutions/CSDSystem/Pages/CSD.aspx>

It contains about half a million structures of small molecules determined by X-ray and neutron diffraction. Suitable software: Mercury

<http://www.ccdc.cam.ac.uk/Solutions/CSDSystem/Pages/Mercury.aspx>

## Protein Data Bank (PDB)

<http://www.pdb.org>

It contains about 94 thousand structures of biomolecular systems determined mainly by X-ray structural analysis.

Experimental method	Proteins (P)	Nucleic acids (NA)	P / NA complexes	Other	Overall
X ray	77445	1481	4069	3	82998
NMR	8851	1046	193	7	10097
electron microscopy	469	45	129	0	643

status in September 2013

# Summary

- Use molecular modelling for problems that cannot be solved by experimental techniques
- Use molecular modelling to complement experimental data
  - NMR, FRET, cryoEM, SAXS, etc.

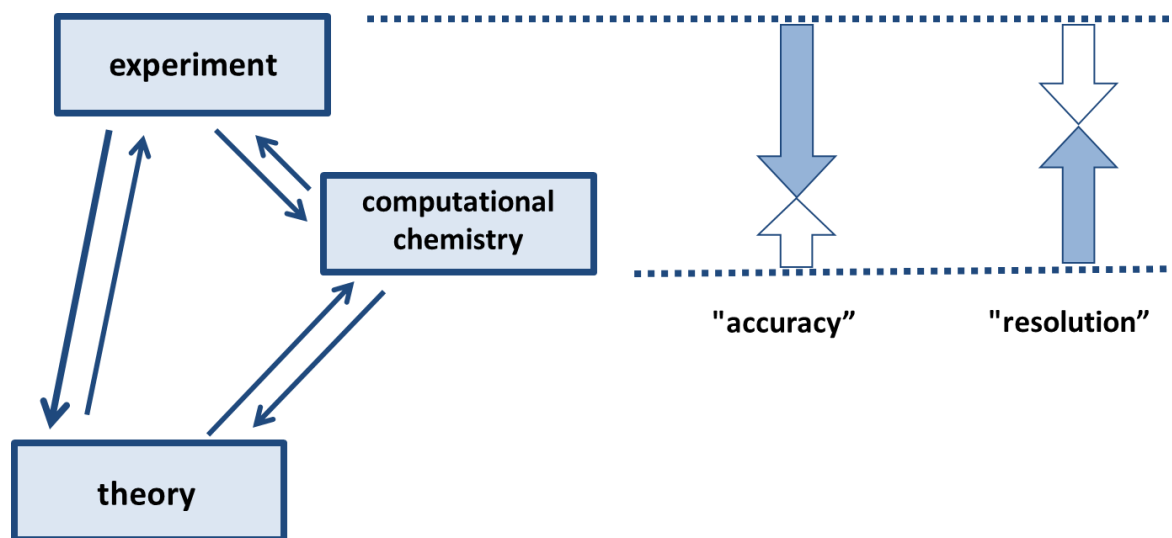

# Homework

---



# Homework

1. What is the typical wavelength of radiation used in X-ray structural analysis?
2. What is the de Broglie wavelength of electrons in electron microscopy for an accelerating voltage of 300 kV?
3. How is the fluorescently labeled enzyme BsoBI prepared (page 13)?
4. How many structures determined by electron microscopy are currently stored in the PDB database?