

# Heterogeneous catalysis

Lecture 5

Catalysts characterization

# Catalyst characterization

- Outline
  - DRUV
  - **XPS**
  - XANES & EXAFS
  - **Chemisorption**
  - **ToF-SIMS**

# Diffuse reflectance UV-Vis spectroscopy (DRUV)

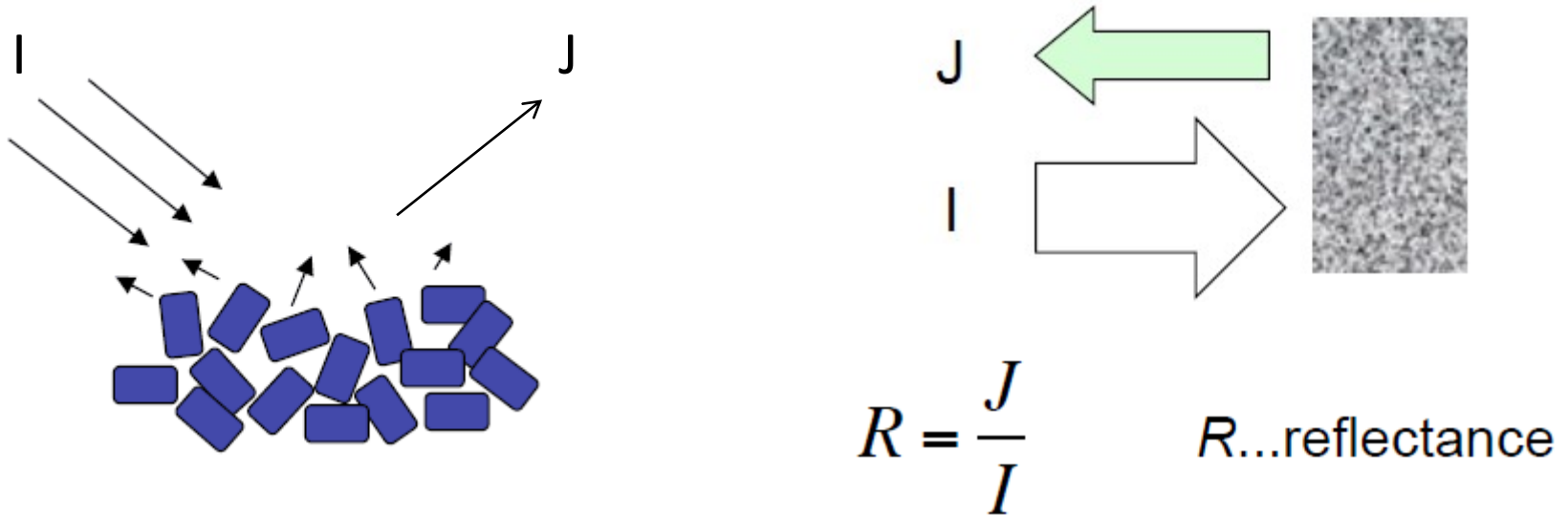

- Is there any link between reflectance and absorbance?
- Yes, there is!
- **Kubelka-Munk model** allows to obtain **quantitatively** the **absorption spectrum** of a solid from diffuse reflectance measurement (theory behind in textbooks)

# Diffuse reflectance UV-Vis spectroscopy (DRUV)

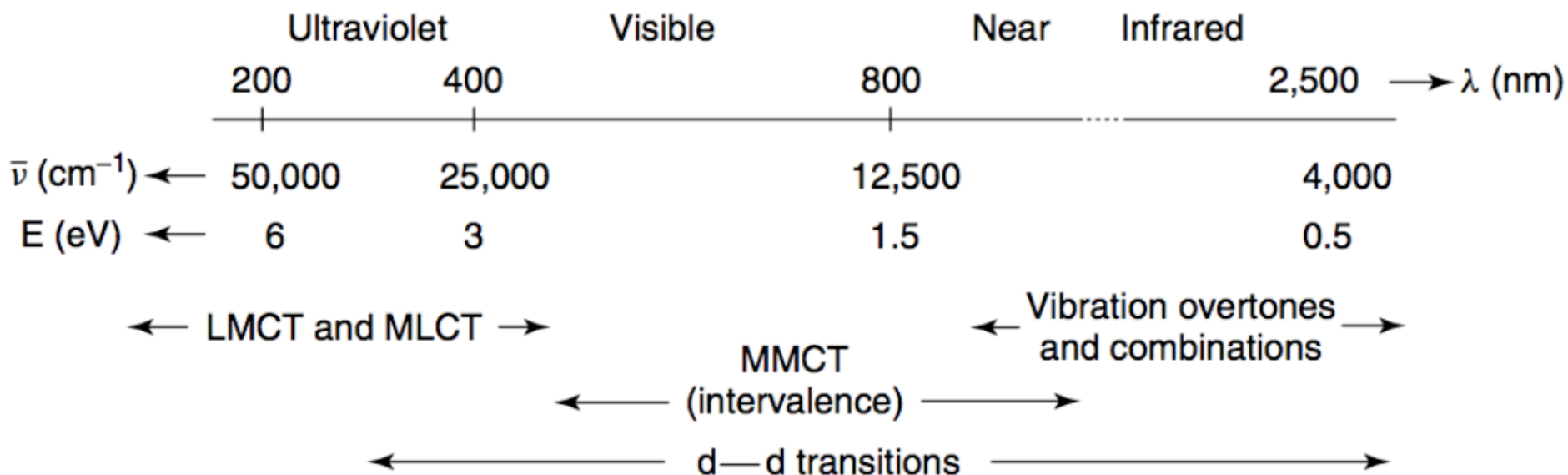

- LMCT = ligand-to-metal charge transfer
- MLCT = metal-to-ligand charge transfer
- MMCT = metal-to-metal charge transfer

# Diffuse reflectance UV-Vis spectroscopy (DRUV)

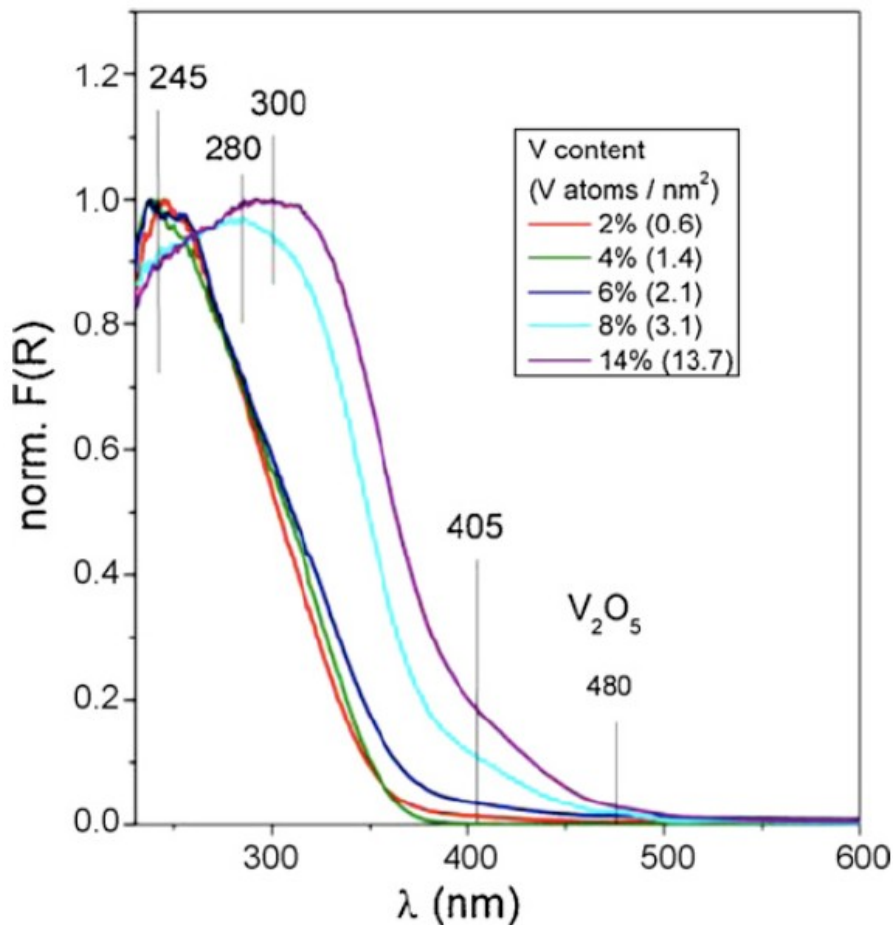

Isolated and polymerized  $V_xO_y$  ?

TABLE 4: Band Maxima and Edge Energies of V-Reference Compounds

compounds	band max. (nm)	$E_g$ (eV)	molecular structure <sup>a</sup>
$V_2O_5$	236, 334, 481	2.3	polymerized $VO_5/VO_6$
$MgV_2O_6$ (meta-vanadate)	250, 370	2.8	polymerized $VO_6$
$NaVO_3$ (meta-vanadate)	281, 353	3.2	polymerized $VO_4$
$NH_4VO_3$ (meta-vanadate)	288, 363	3.2	polymerized $VO_4$
$Mg_2V_2O_7$ (pyro-vanadate)	280	3.5	dimeric $VO_4$
$Mg_3V_2O_8$ (ortho-vanadate)	260, 303	3.5	isolated $VO_4$
$Na_3VO_4$ (ortho-vanadate)	253, 294	3.9	isolated $VO_4$

Gao et al., *J. Phys. Chem. B* 102 (1998) 10842.

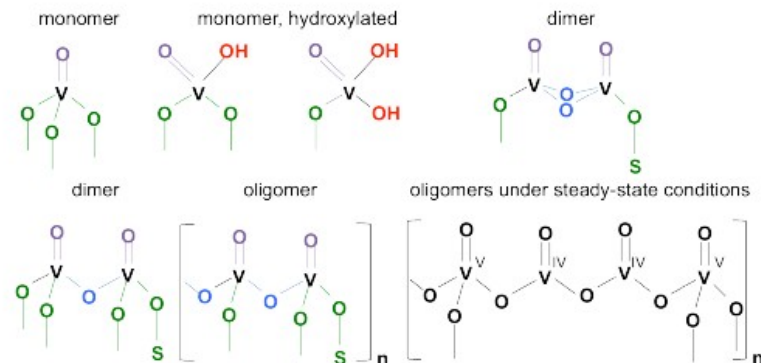

# Ionization Spectroscopies

Photoelectron spectroscopy:

UV: valence shell ionizations

X-ray: core electron ionizations  
(XPS, XANES, EXAFS):

$$E_{\text{photon}} = h\nu =$$

BE + kinetic energy (KE)

**Photoelectron Spectroscopy** analyzes the energies of the ionized electrons (XPS).

**X-ray Absorption Spectroscopy** analyzes the absorption curve of the X-ray spectrum associated with ionization of a core electron (XANES and EXAFS)

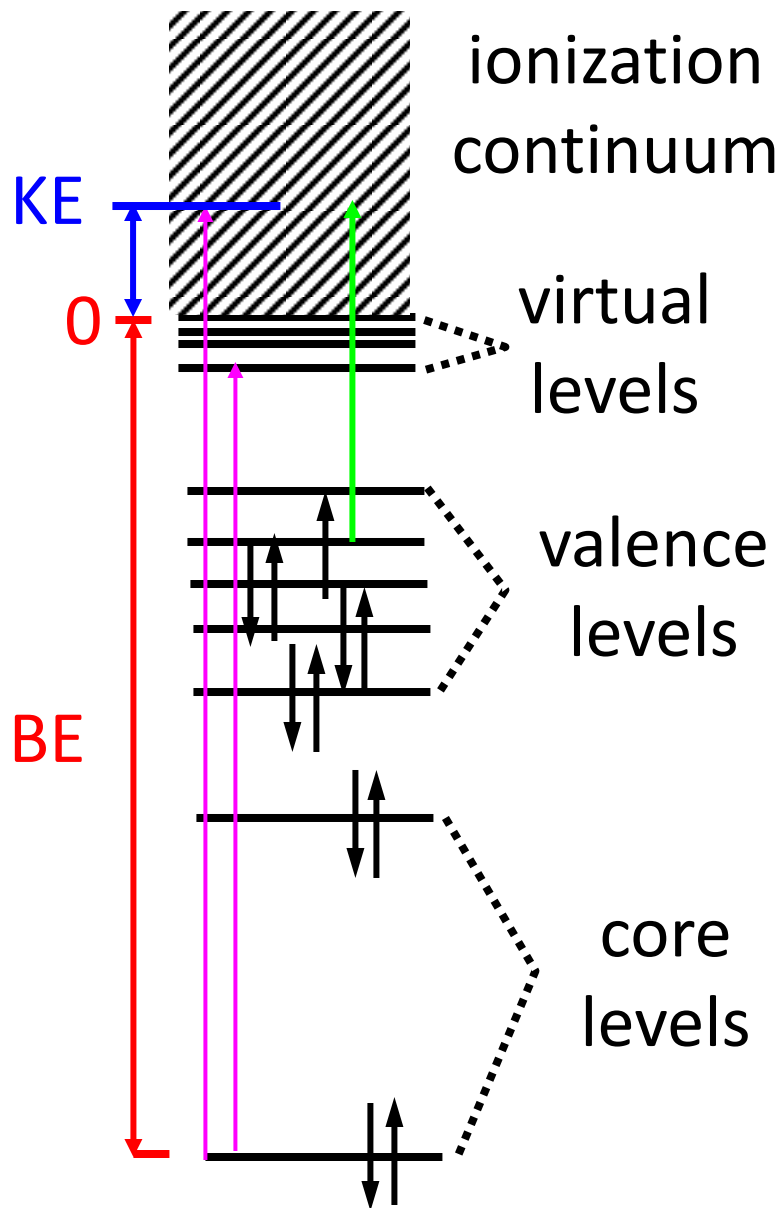

# X-ray photoelectron spectroscopy (XPS)

We measure the number and the energy of photoelectrons emitted from the surface layer

$$E_{\text{photon}} = h\nu =$$

**BE** + kinetic energy (**KE**)

- Number of photoelectrons gives access to quantity
- Energy of photoelectrons gives access to quality
- Depth? 5–20 nm.

# X-ray photoelectron spectroscopy (XPS)

Survey

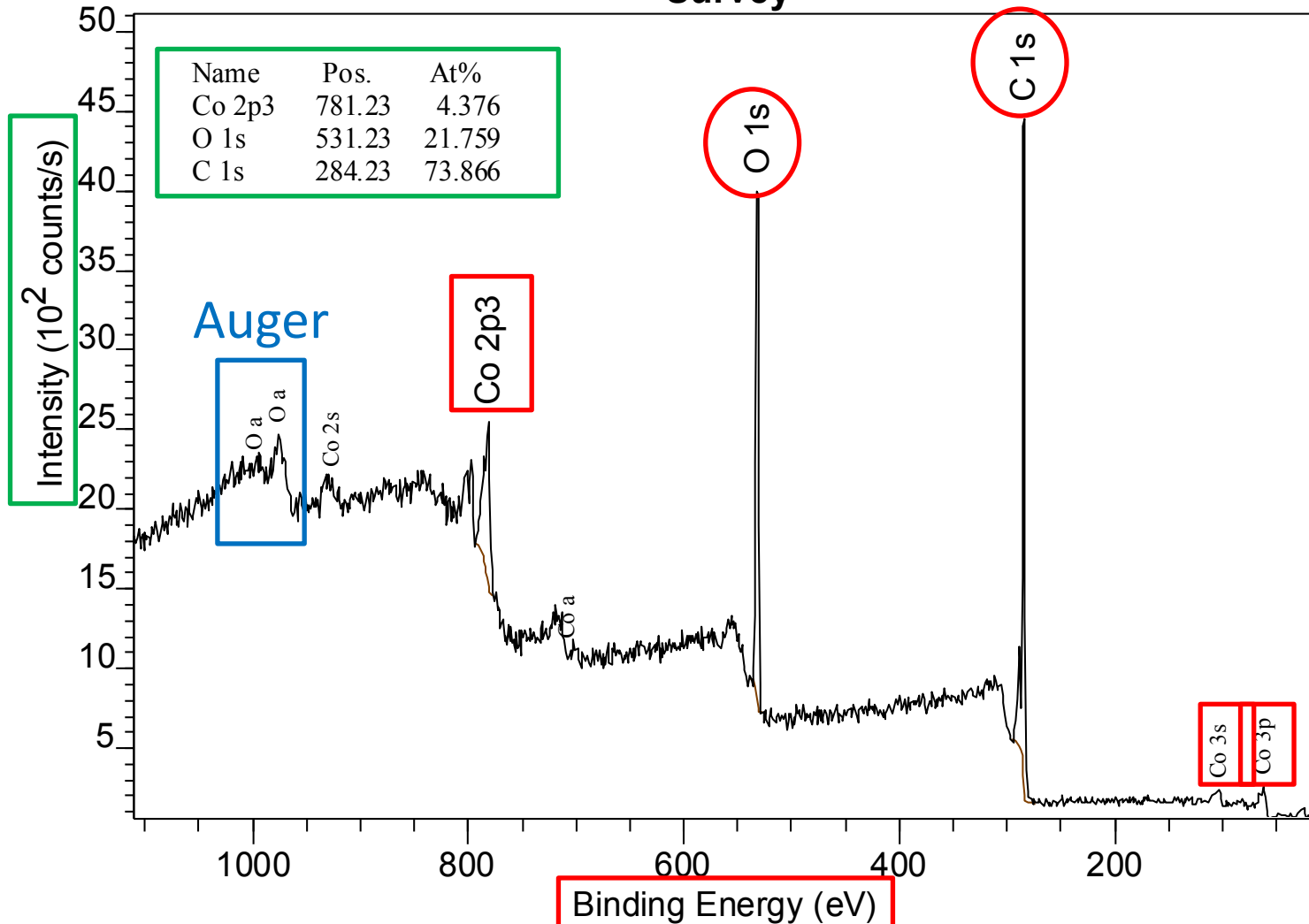



# X-ray photoelectron spectroscopy (XPS)

- Surface vs. bulk composition

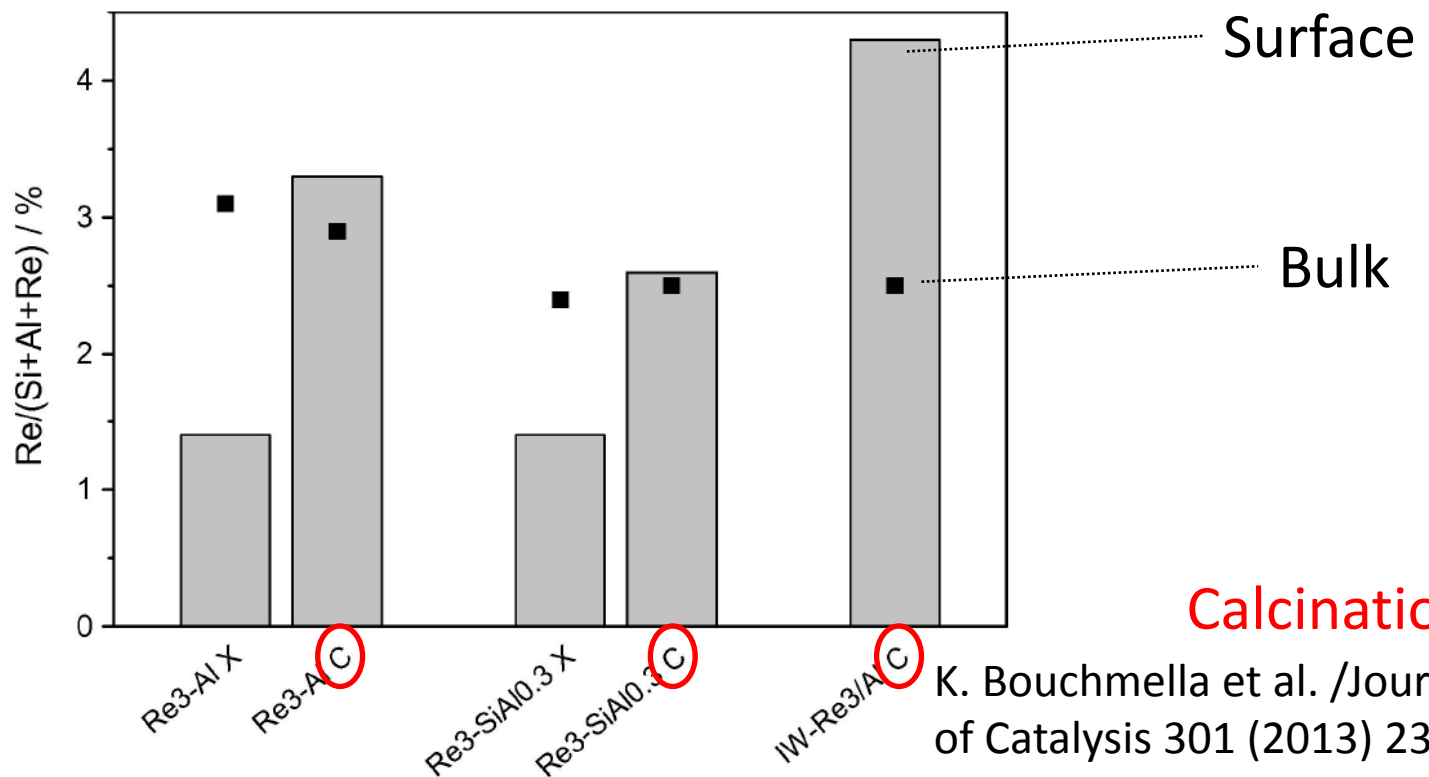

Calcination  
K. Bouchmella et al. /Journal of Catalysis 301 (2013) 233–241

**Figure 6.** Surface Re/(Si + Al + Re) atomic ratios (XPS, gray bars) and bulk Re/(Si + Al + Re) atomic ratios (EDX, black squares) for xerogels and calcined catalysts. Reproduced with permission from [177]. Copyright Elsevier, 2013.

# X-ray photoelectron spectroscopy (XPS)

- Oxidation state

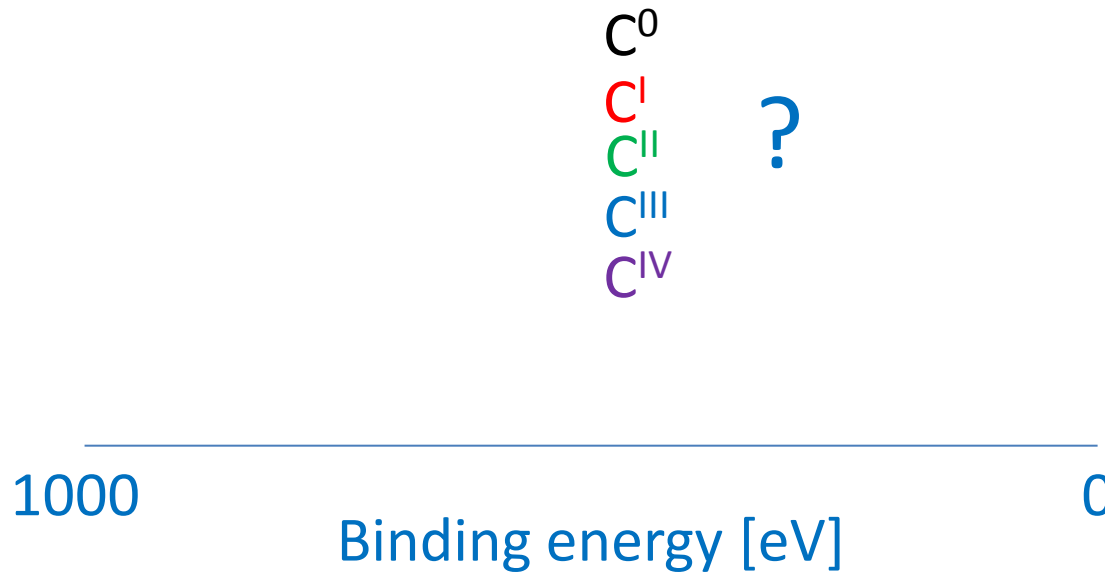

- Who will hold its electrons more powerfully? C<sup>0</sup> or C<sup>IV</sup>?

# X-ray photoelectron spectroscopy (XPS)

- Oxidation state

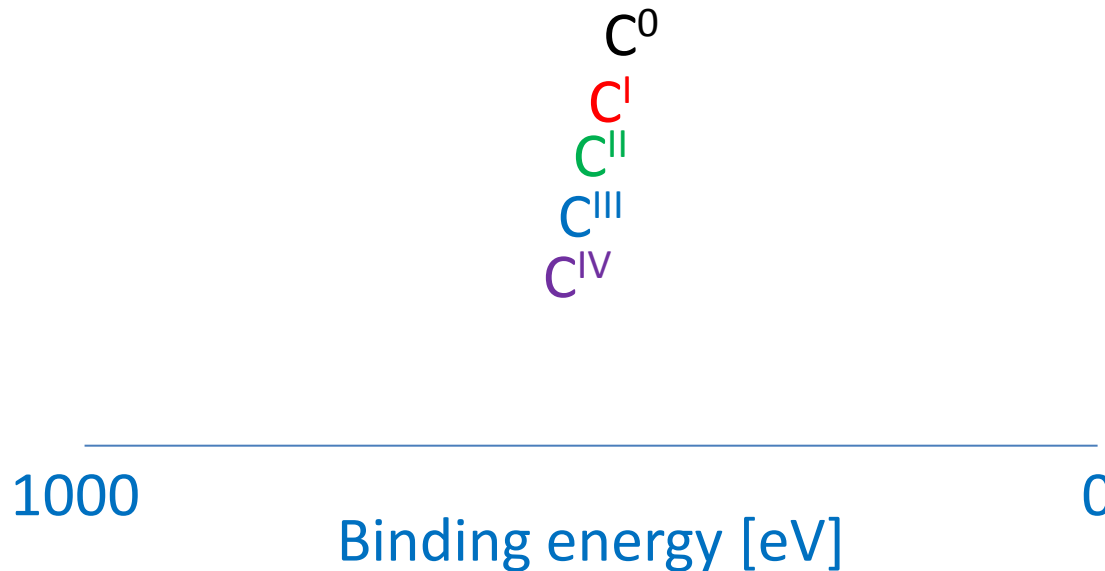

- Why do we talk about carbon?
- **Surface of each sample** contains some carbon impurities = **Adventitious carbon = calibration of BE**

# X-ray photoelectron spectroscopy (XPS)

- Oxidation state

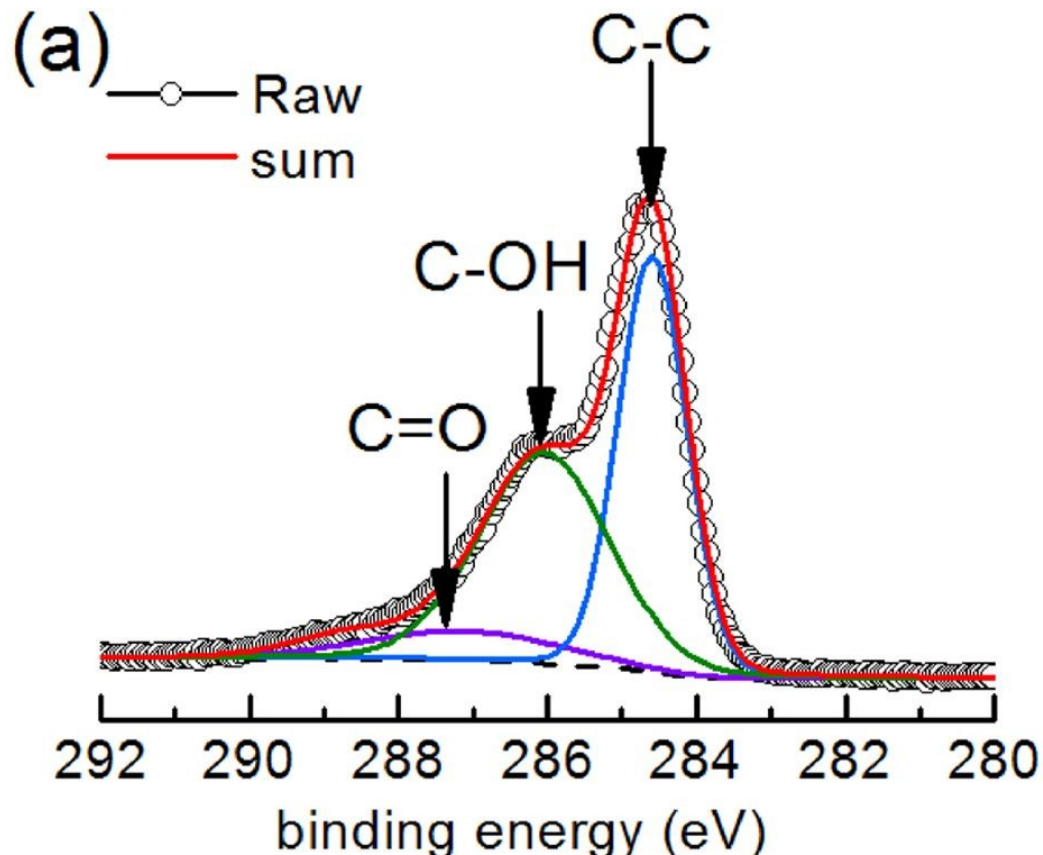

# X-ray photoelectron spectroscopy (XPS)

- Similar consideration:

SiO<sub>4</sub> vs. CSiO<sub>3</sub>

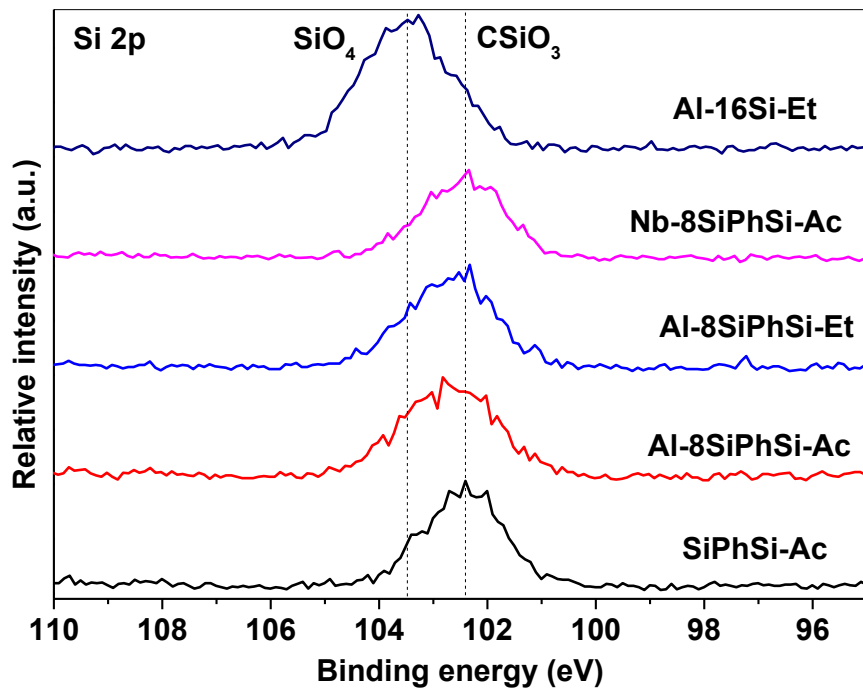

Electronegativity (O) =  
Electronegativity (C) =

Ta(OSi)<sub>x</sub>(OTa)<sub>6-x</sub> vs. Ta(OTa)<sub>6</sub>

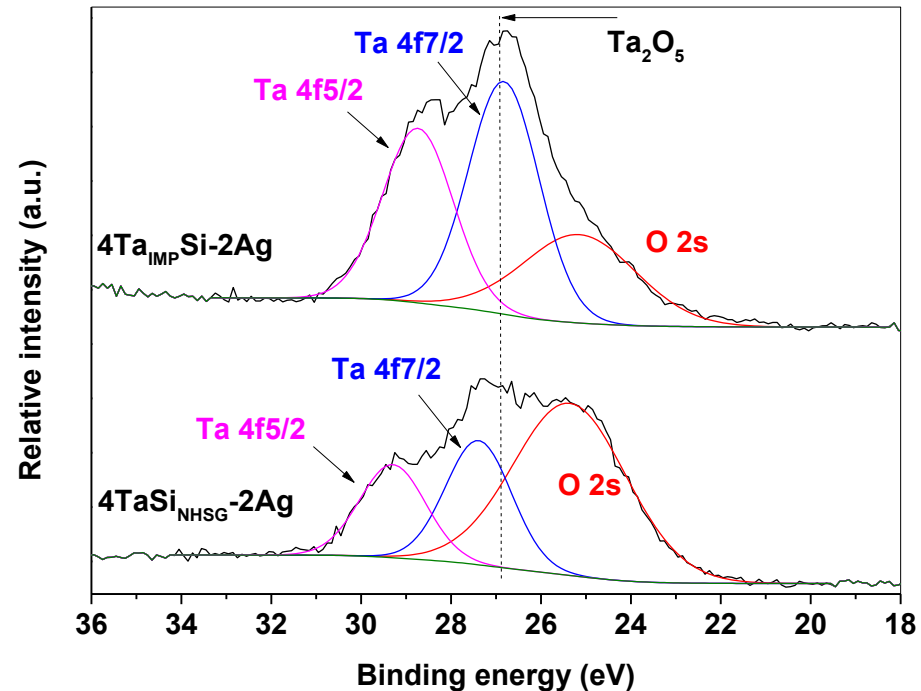

Electronegativity (Si) =  
Electronegativity (Ta) =

# X-ray photoelectron spectroscopy (XPS)

- Spin-orbital interaction and other electron interactions lead to additional features in XP spectra characteristic for
  - Oxidation states
  - Groups
  - ...

Characteristic for  $\text{Mn}^{2+}$

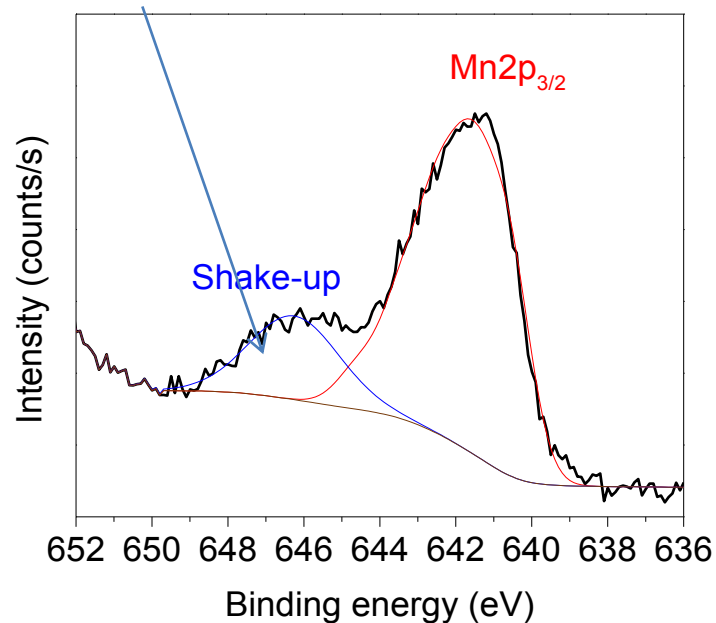
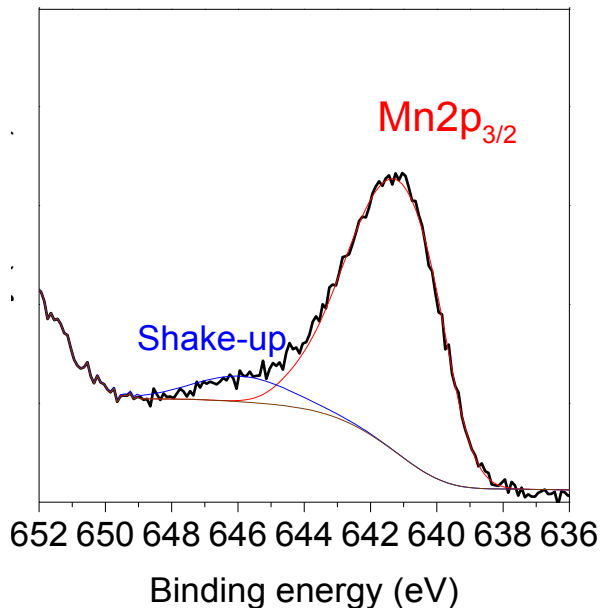

# X-ray photoelectron spectroscopy (XPS)

- Spin-orbital interaction and other electron interactions lead to additional features in XP spectra characteristic for
  - Oxidation states
  - Groups
  - ...

Characteristic for aromatic carbon

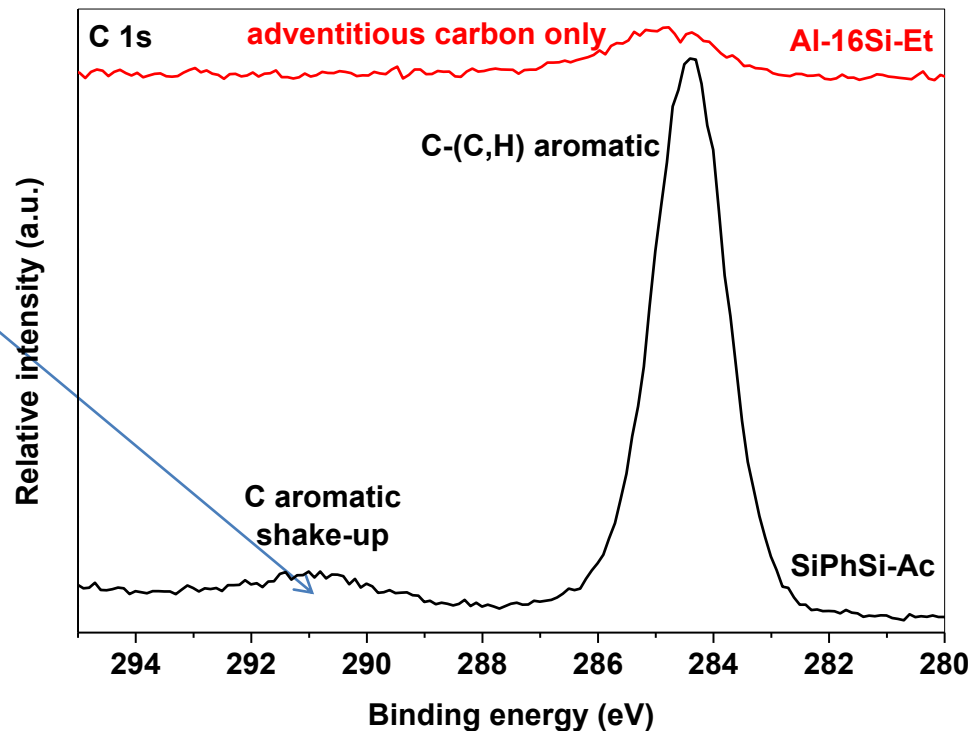

# Ionization Spectroscopies

Photoelectron spectroscopy:

UV: valence shell ionizations

X-ray: core electron ionizations  
(XPS, XANES, EXAFS):

$$E_{\text{photon}} = h\nu =$$

BE + kinetic energy (KE)

**Photoelectron Spectroscopy** analyzes the energies of the ionized electrons (XPS).

**X-ray Absorption Spectroscopy** analyzes the absorption curve of the X-ray spectrum associated with ionization of a core electron (XANES and EXAFS)

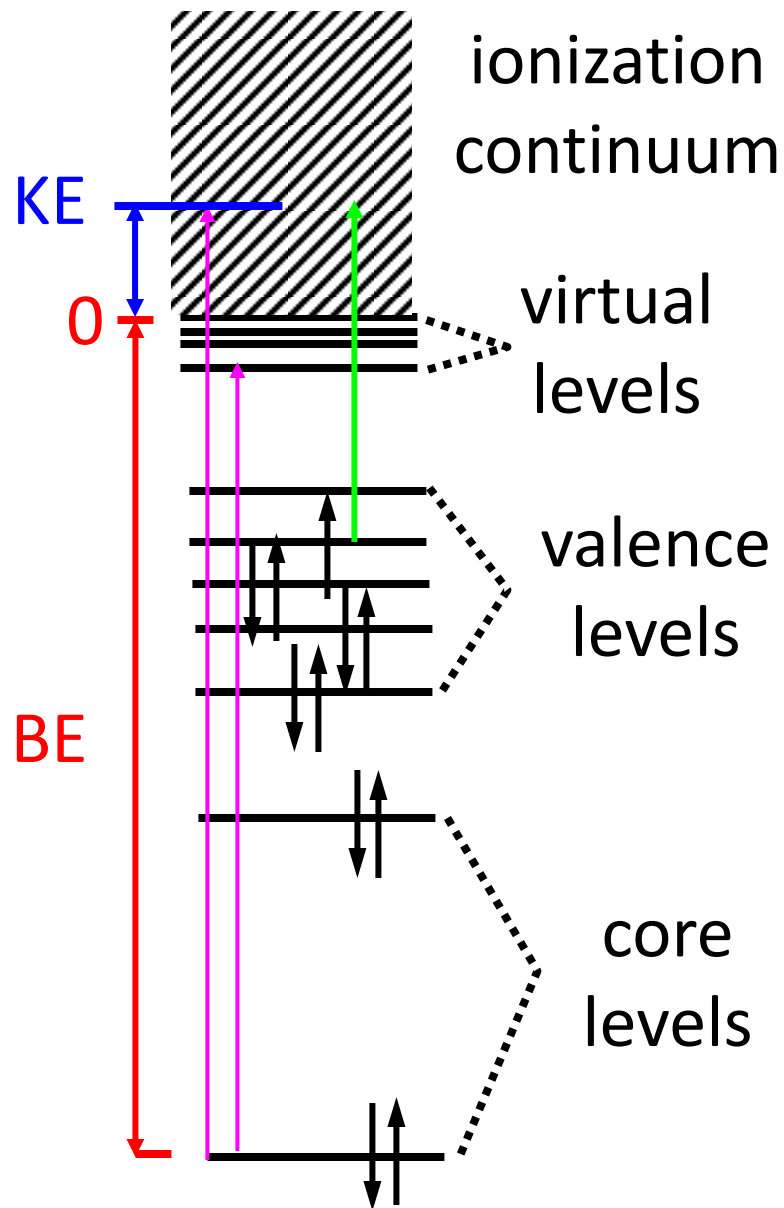



# XANES and EXAFS

In XANES and EXAFS we measure number and energy of transmitted photons, which caused ionization of a core electron (i.e. absorbance vs. energy)

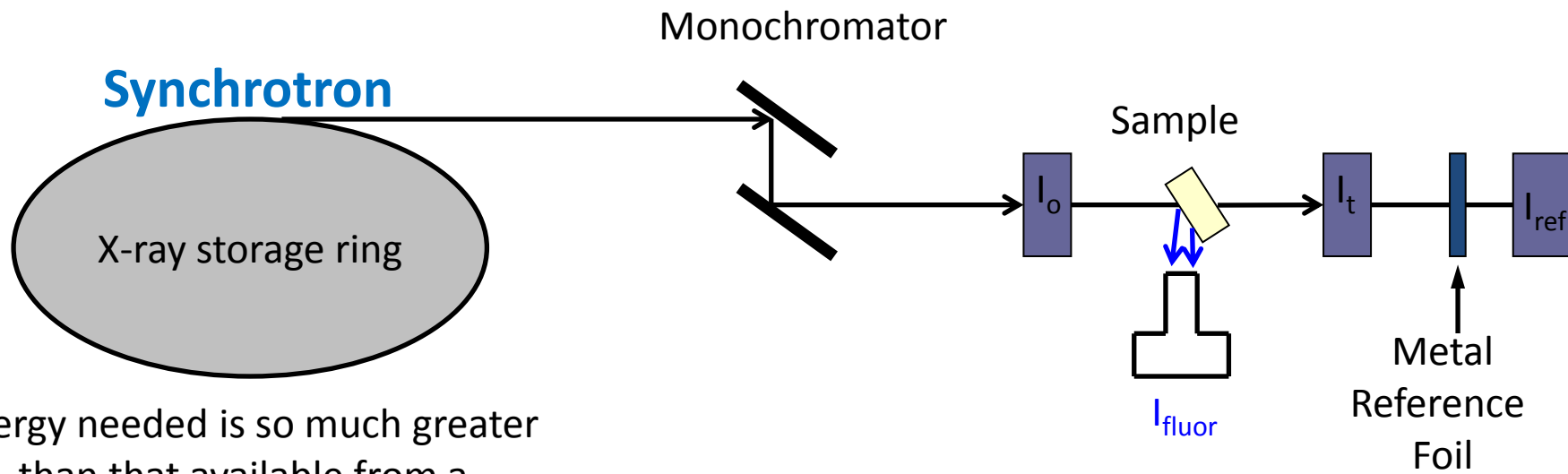

Energy needed is so much greater than that available from a typical X-ray tube found in most labs

# XANES and EXAFS

- XAS: X-ray **absorption** spectroscopy; alternatively XAFS: X-ray **absorption** fine structure
  - XANES: X-ray **absorption** near edge structure (pre-edge); alternatively NEXAFS (near edge x-ray absorption fine structure)
  - EXAFS: Extended x-ray **absorption** fine structure (= behind edge)

What is an edge?

# XANES and EXAFS

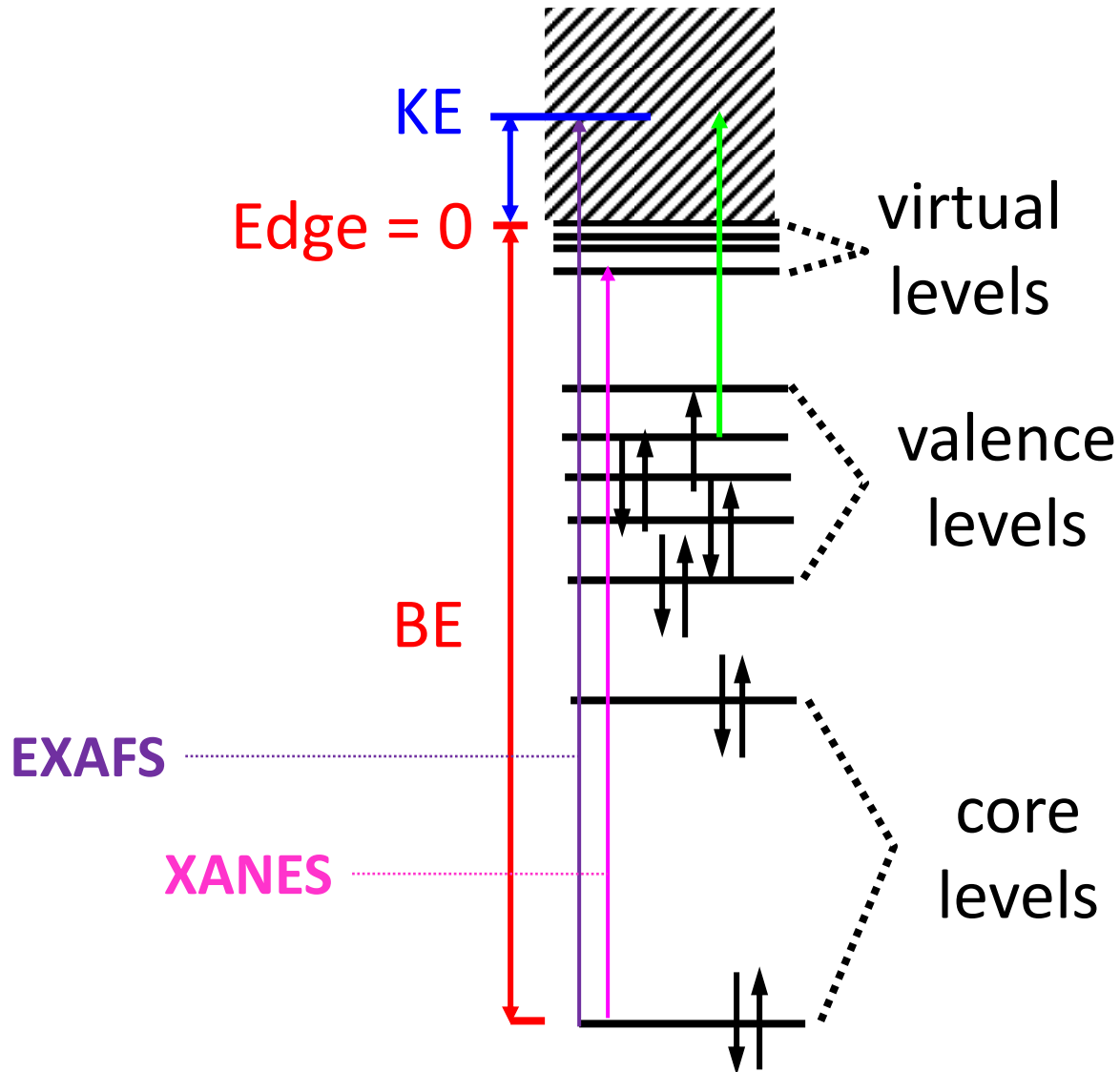

# XANES and EXAFS

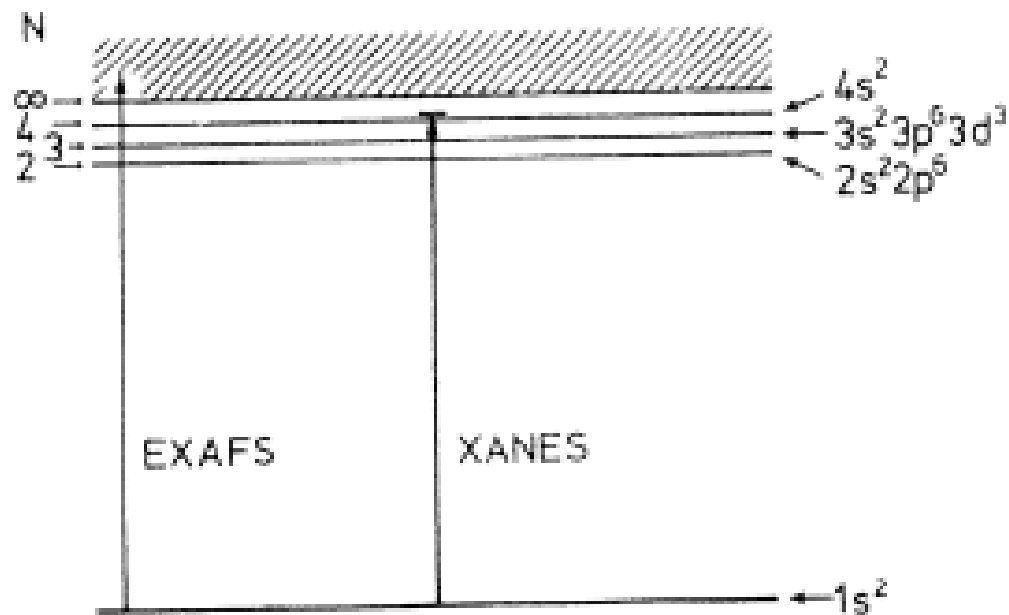
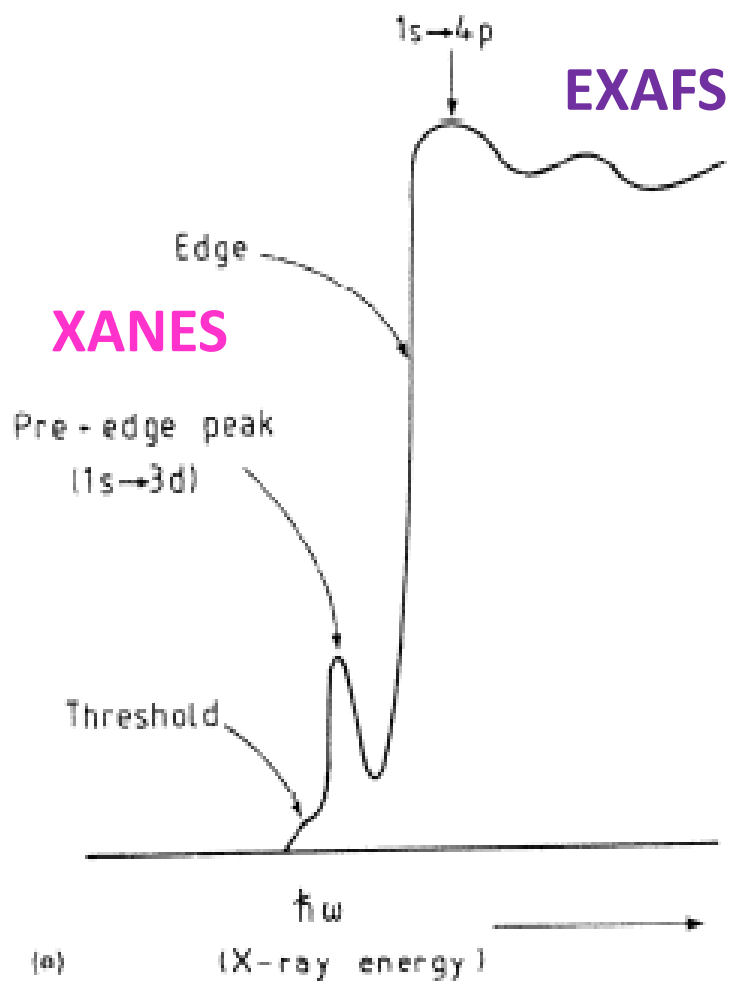

**Figure 3.36** (a) Representation of the X-ray K-edge absorption spectra (XANES) obtained from solids containing vanadium. (b) Schematic energy level diagram for vanadium. The transitions are from the K-shell to empty valence states. XANES involves transitions to valence states and can thus be used to probe chemical bonding.

# XANES

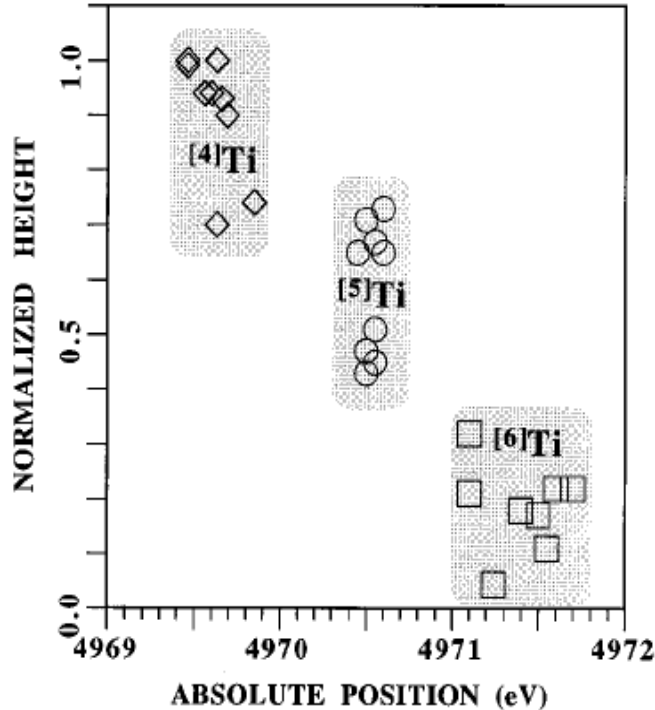
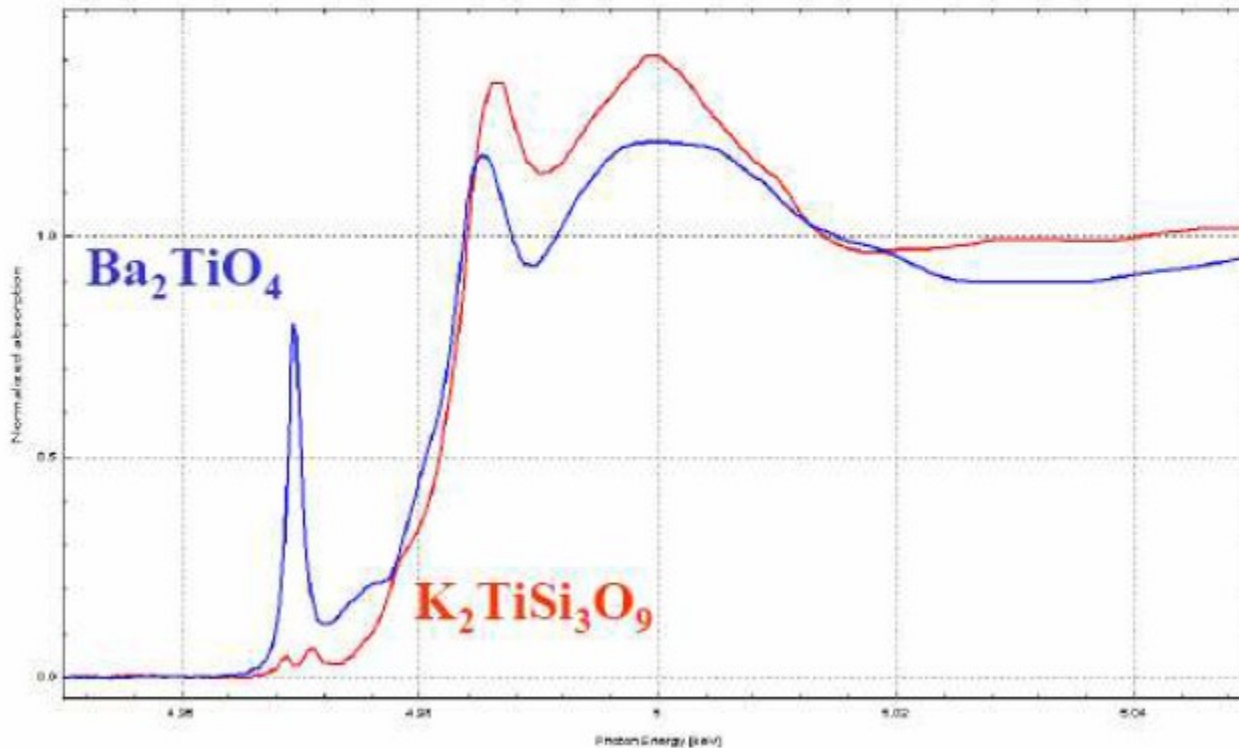

FIG. 2. Normalized pre-edge height vs energy position for Ti K-pre-edge features in model compounds listed on Table I showing three domains for fourfold, fivefold, and sixfold coordinated Ti.

- Qualitative information on coordination environment (dipole selection rules apply)
  - Is there a pre-edge feature?
    - Yes – no inversion center
    - No – there is an inversion center
- Quantitative info also possible
- Figure from Farges, et. al. *Physical Review B: Condens. Matter* **1997**, 56(4), 1809-1819.

# XANES

- Coordination environment



Both  $\text{Ti}^{4+}$

$\text{Ba}_2\text{TiO}_4$



$\text{K}_2\text{TiSi}_3\text{O}_9$



# XANES

- Position of the edge...binding energy...oxidation state

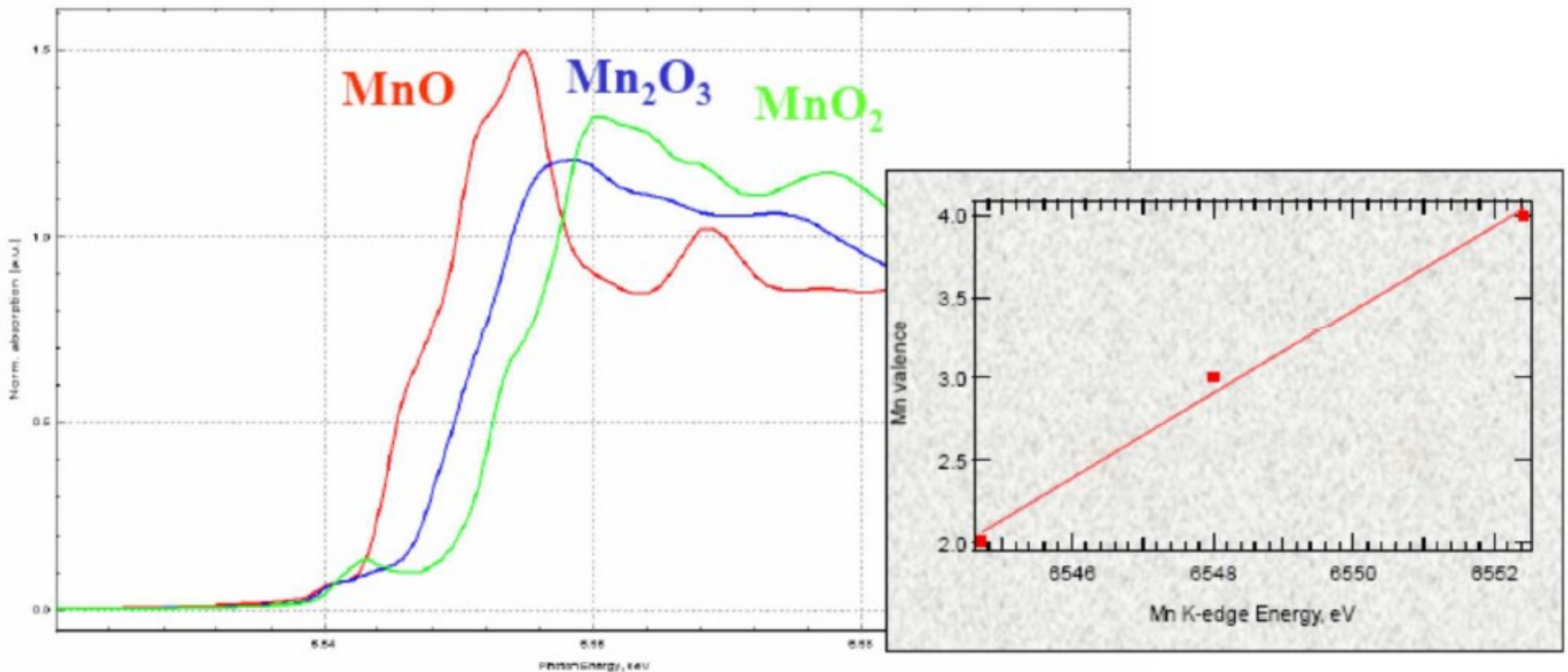

# EXAFS

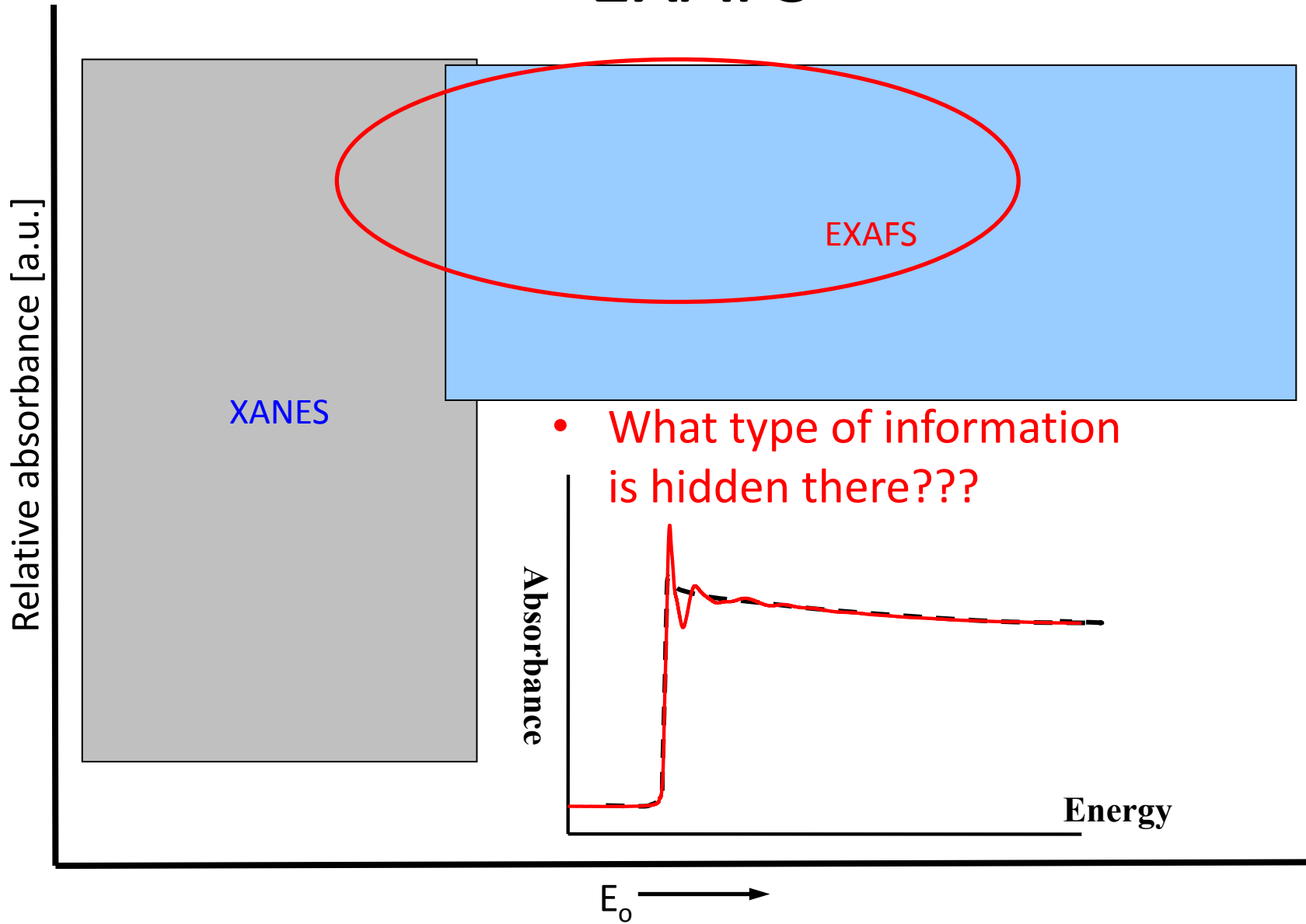



# EXAFS

- The scattering phenomena

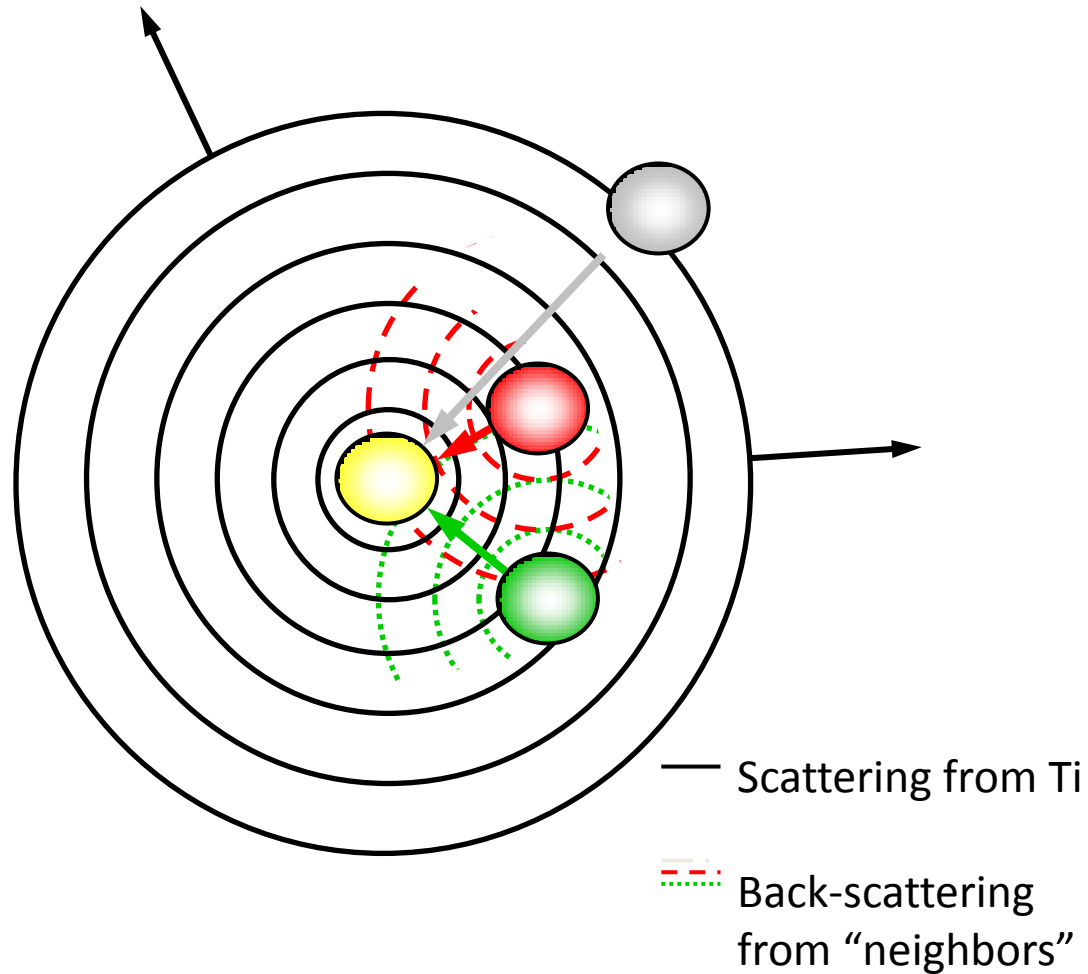

# EXAFS

Step 1: The data

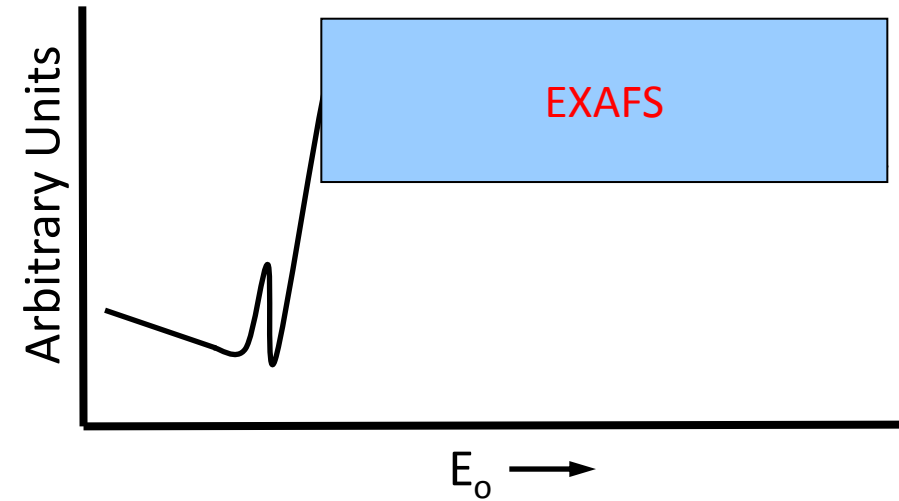

Math  $\rightarrow$

Step 2: Extract  $\chi(k)$

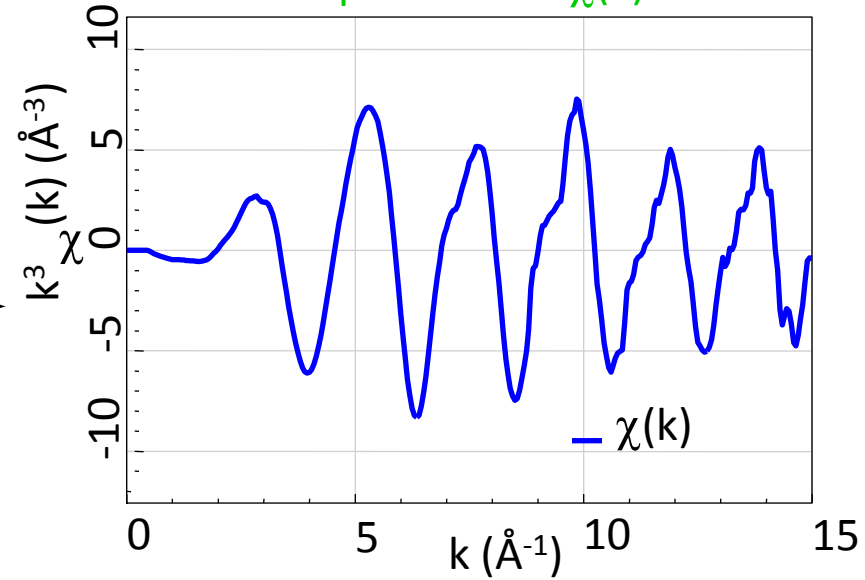

Fourier Transform  $\downarrow$

Step 3: The FT

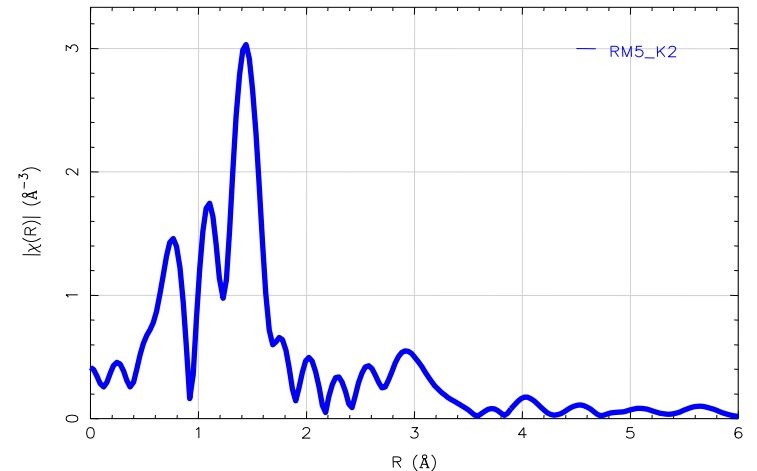

Step 4:

Develop structural model  
that fits that data  
 $d(M-X)$ ,  $CN(X)$ ,  
 $AtNum(X)$



# EXAFS

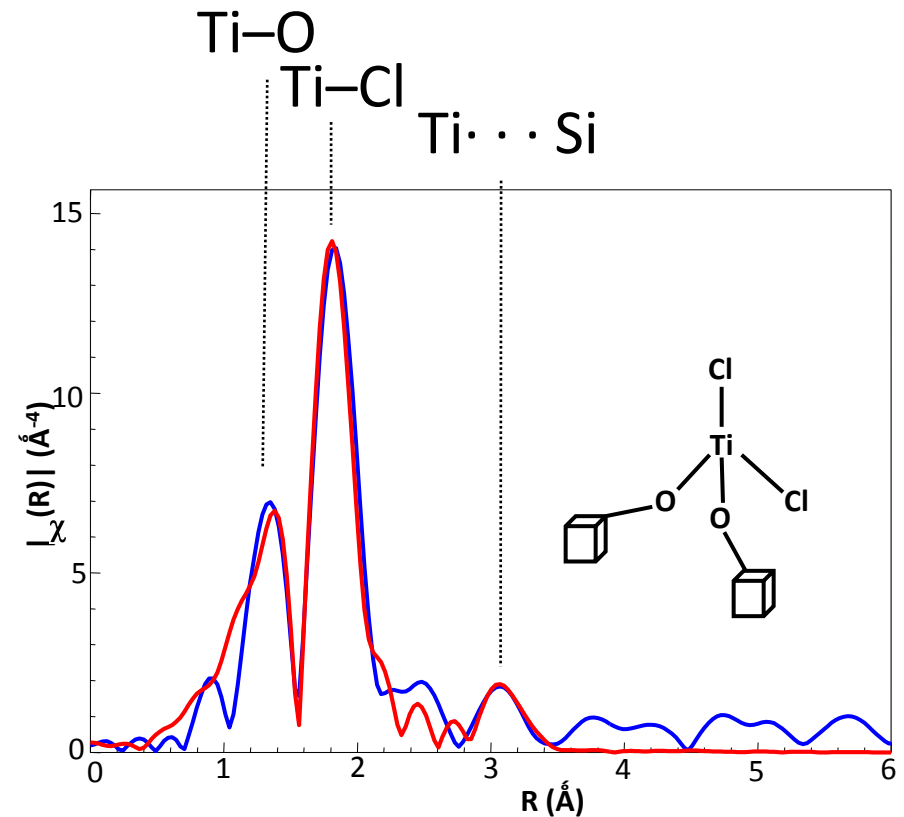
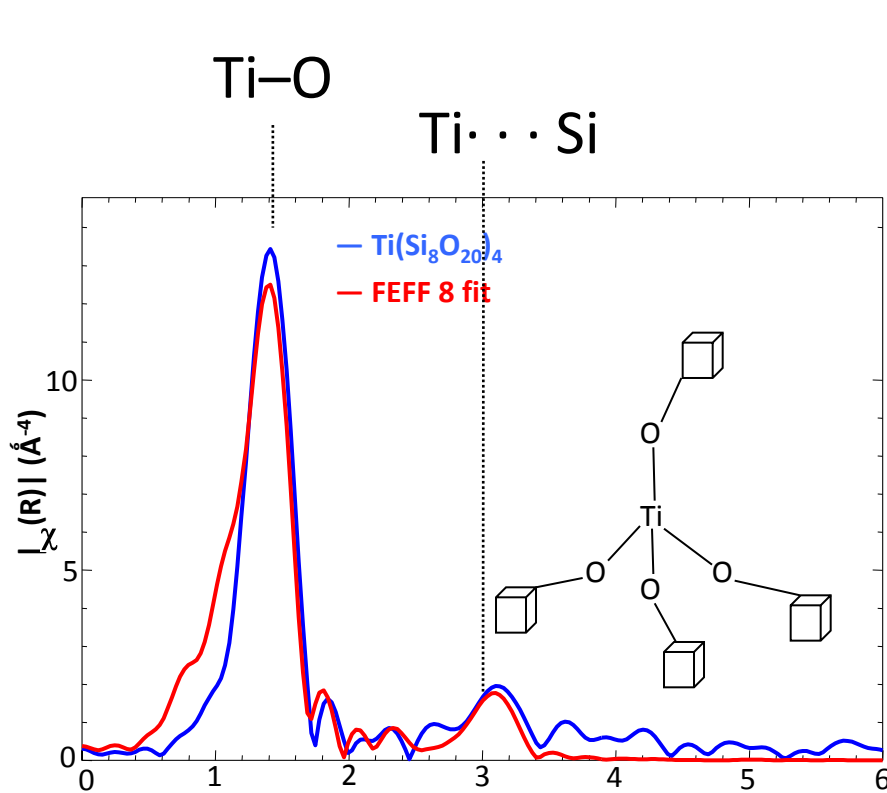

- Structure elucidation of an amorphous material!
- If more Ti sites, than average; analysis more difficult!

# Chemisorption

- Interactions of A,B, and P with catalyst not too weak, not too strong  
(= physi/chemisorption on catalyst surface)

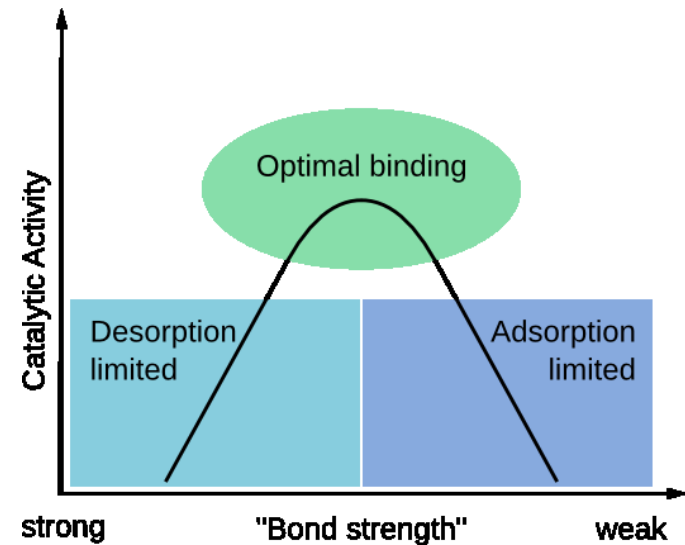

**Sabatier's principle;**  
**Volcano plot@Lecture 1**

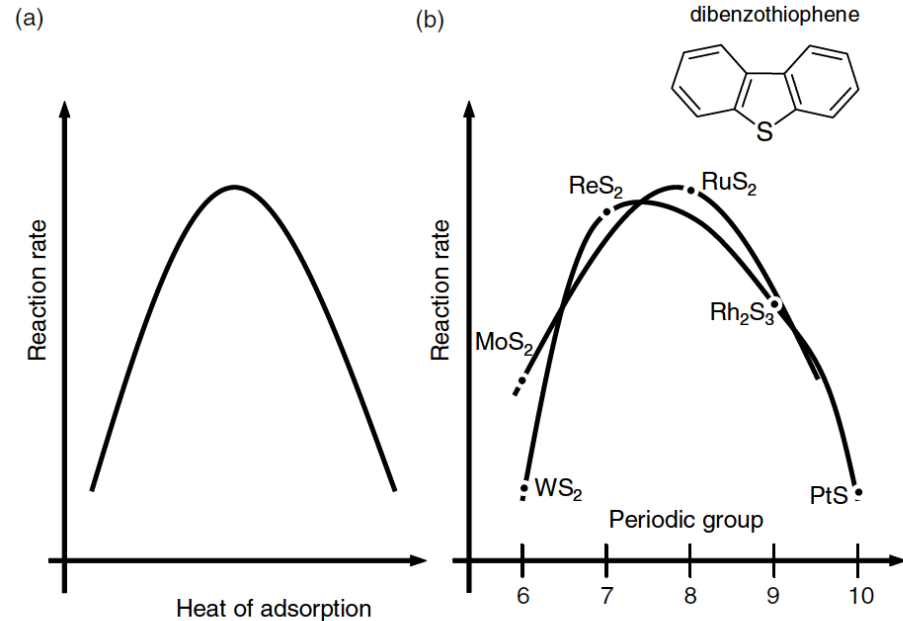

Figure 2.15 Examples of volcano plots, describing the reaction rate as a function of the heat of adsorption (*left*), and the activity of the second-row and third-row transition metal sulfides in the hydrodesulfurization of dibenzothiophene (*right*).

# Chemisorption

- Different sites = different probes
  - Acid sites
    - $\text{NH}_3$ , alkylamines, pyridine, 2,6-dimethylpyridine, CO
  - Basic sites
    - $\text{CO}_2$
  - Redox
    - $\text{H}_2$ ,  $\text{O}_2$ ,  $\text{N}_2\text{O}$
  - Reactants can be used as probes
    - e.g. ethanol dehydration = I can study chemisorption of ethanol

# Chemisorption

- Different ways how to do it
  - Volumetric
  - Thermally programmed desorption/oxidation/reduction
  - Pulse titration
  - Chemisorption of IR (NMR) active molecules and their analysis by IR (NMR)

# Chemisorption

- Volumetric
  - Similar to N<sub>2</sub> physisorption (glass tube of known volume, addition of known volume of gas, pressure measurement)
  - NH<sub>3</sub> adsorption isotherms measured twice, sample evacuated between the two measurements  
(physisorption vs. chemisorption)
  - High temperatures in contrary to N<sub>2</sub> physisorption (e.g. 50 °C)

# Chemisorption

- Volumetric

Temperature?

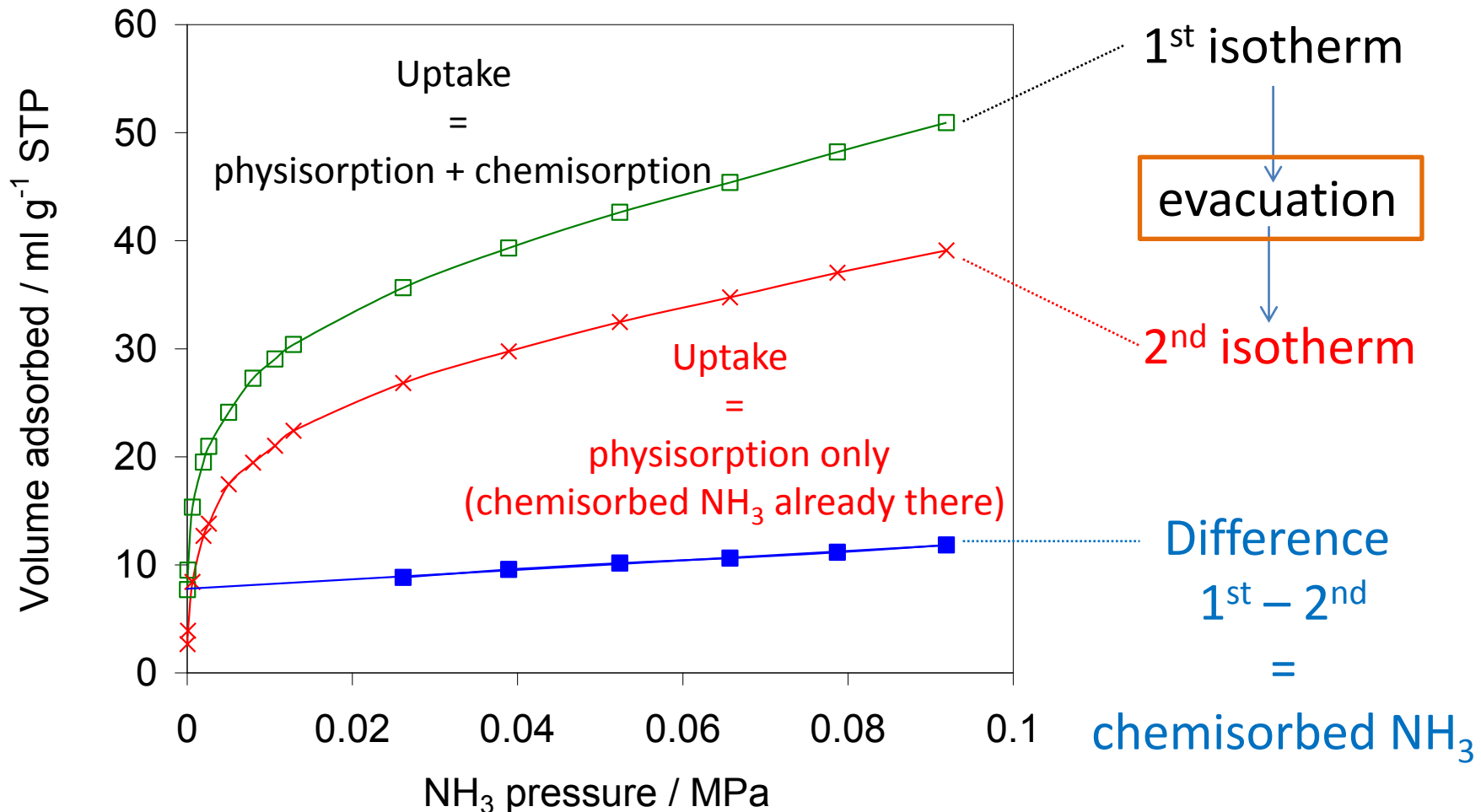



# Chemisorption

- Thermally programmed desorption/oxidation/reduction

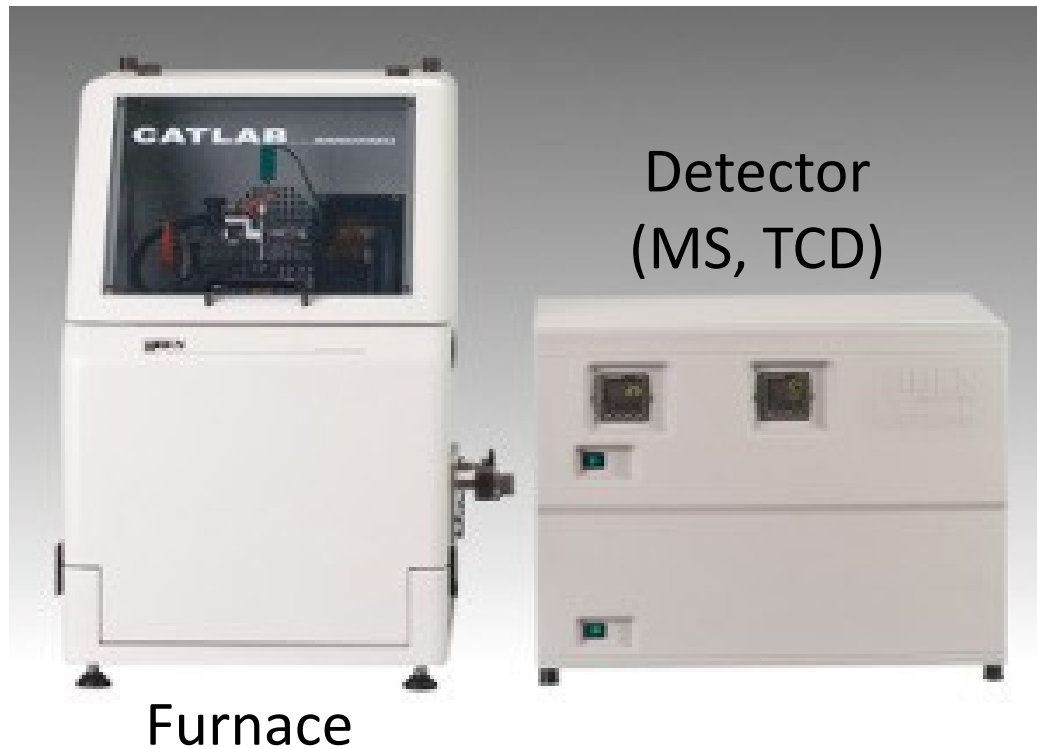
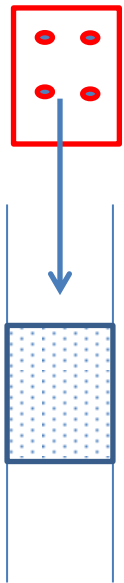

# Chemisorption

- Thermally programmed desorption/oxidation/reduction

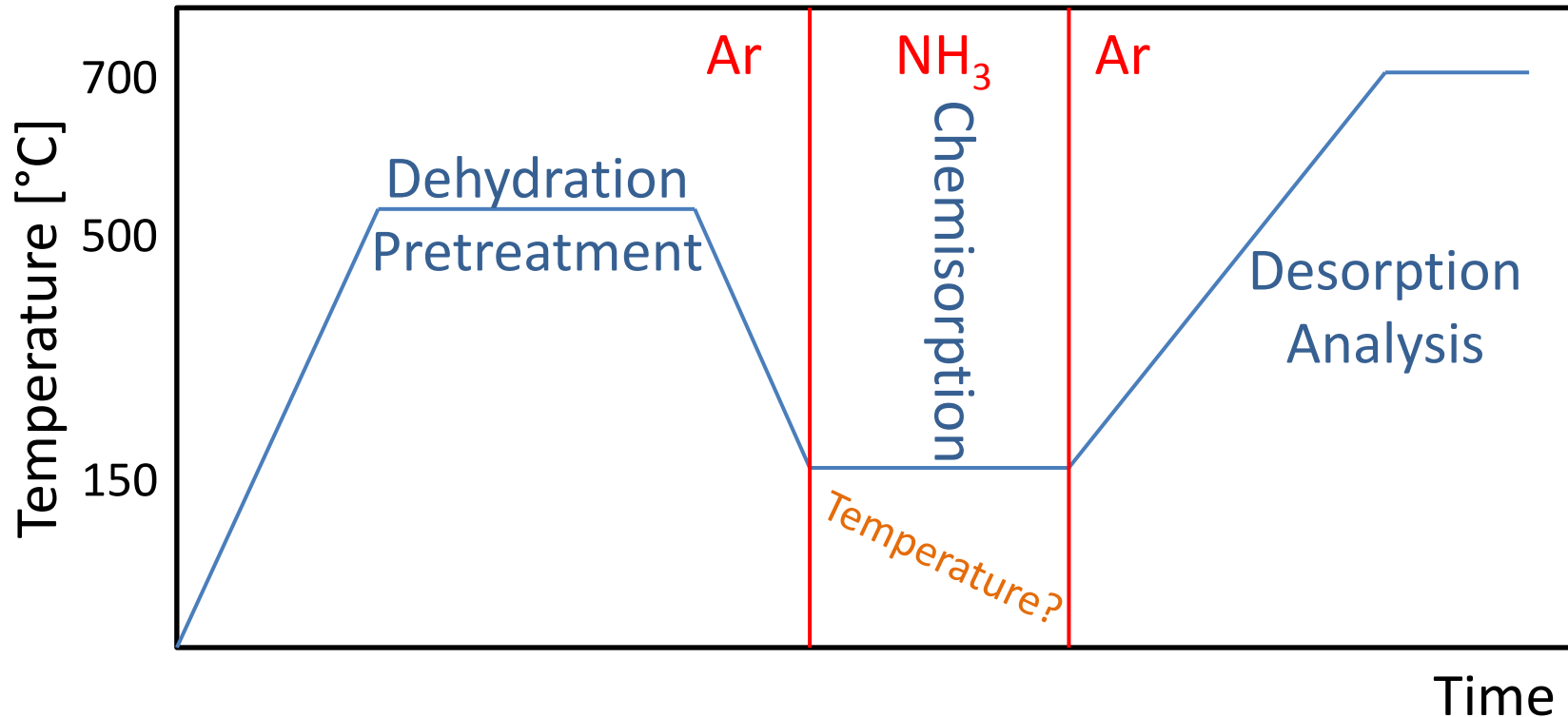

# Chemisorption

- Thermally programmed ...

NH<sub>3</sub> TPD

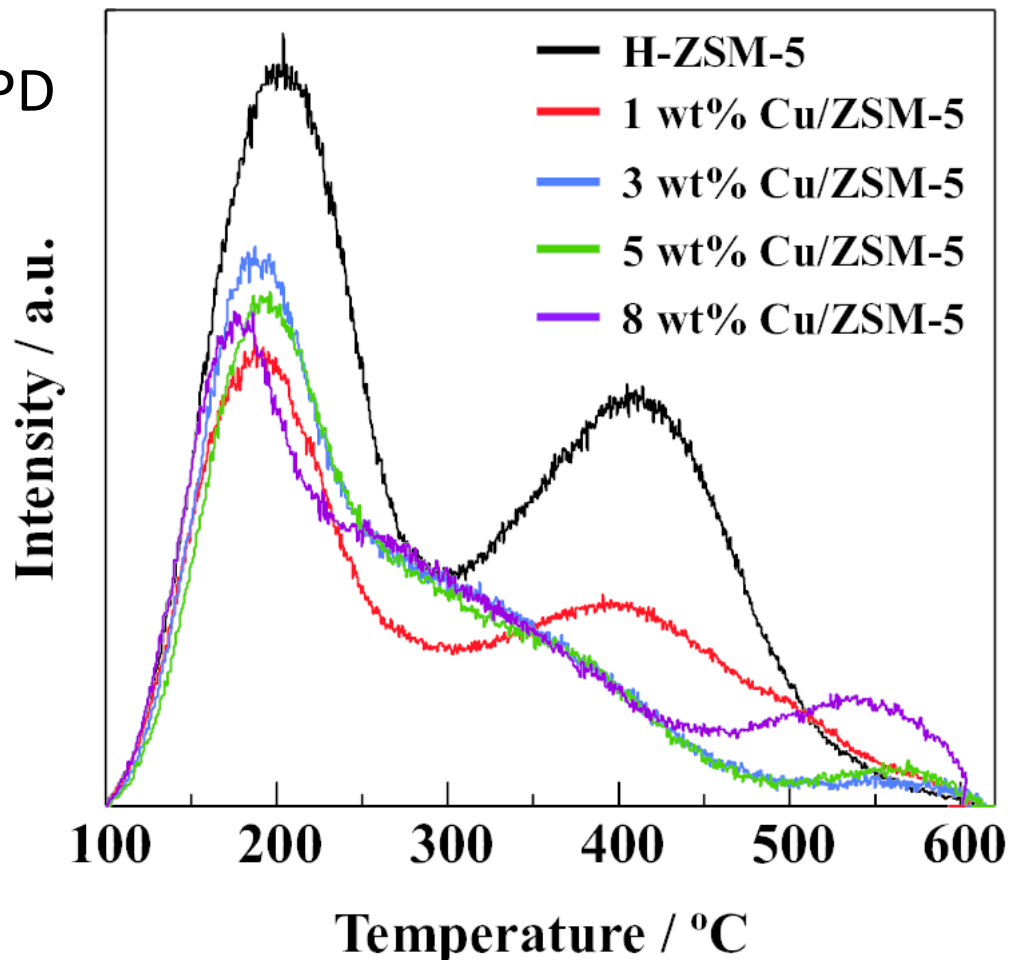

# Chemisorption

- Pulse titration

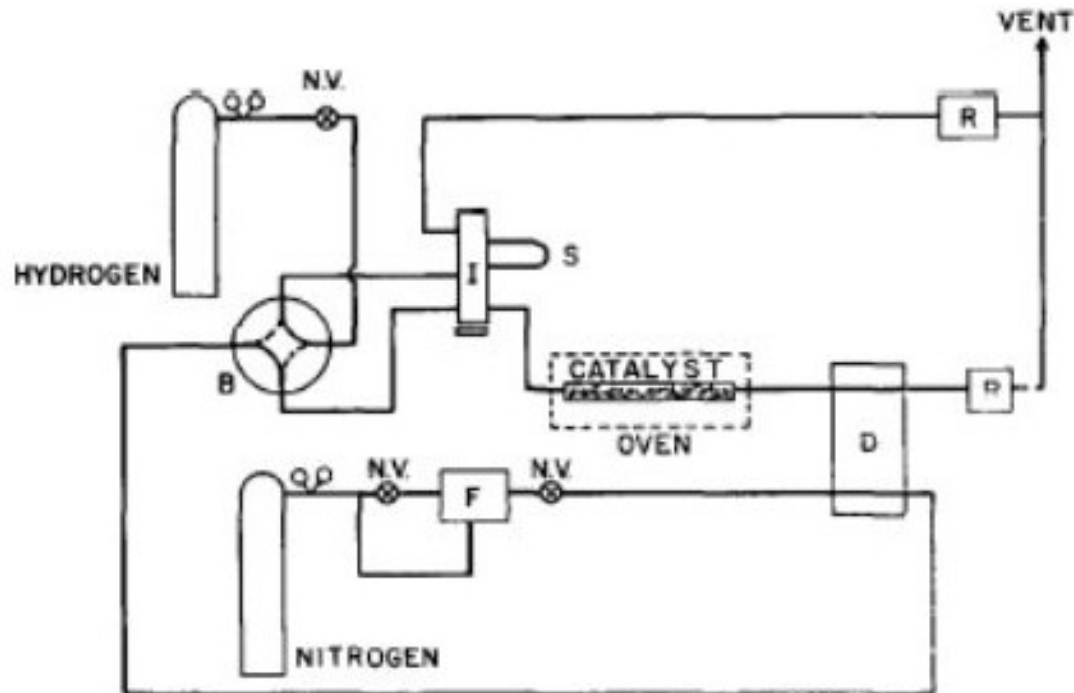
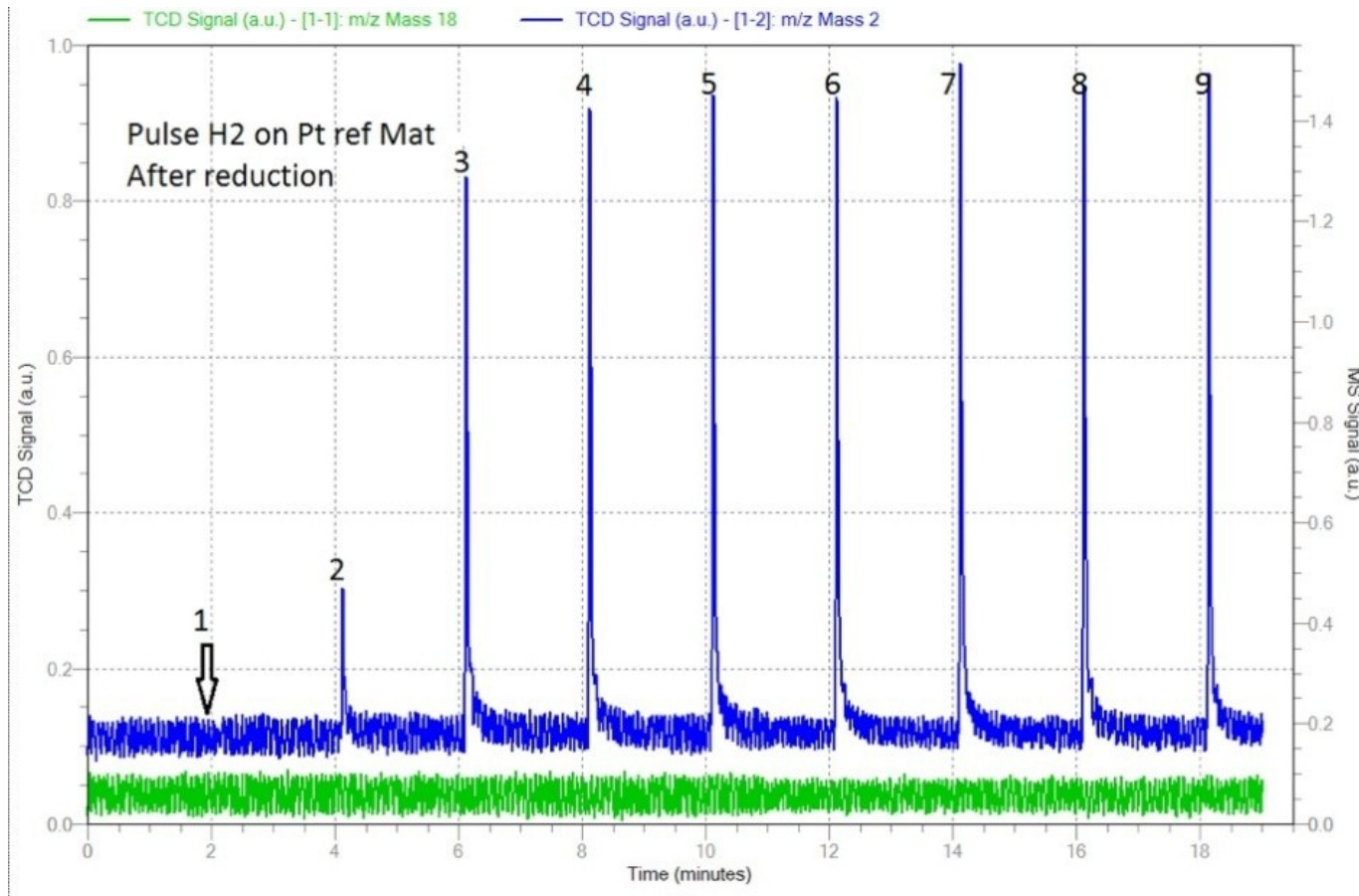

FIG. 1. Schematic of the flow system. F = "Moore" flow controller, N.V. = needle valve, D = thermal conductivity detector, B = g.c. backflush valve, I = 6-port "Varian" sample-injector, S = sample loop, R = rotameter. The setup for hydrogen adsorption is shown. Prereduction was carried out with the valve B in its alternate position. Oxygen chemisorption was studied by replacing the hydrogen source with oxygen.

# Chemisorption

- Pulse titration



# Chemisorption

- Pulse titration
  - Correct choice of gas ( $H_2$ ,  $CO$ ,  $O_2$ ,  $N_2O$ )
  - Correct choice of **temperature**
    - = Monolayer
    - = Dispersion, particle size, „active metal surface area“

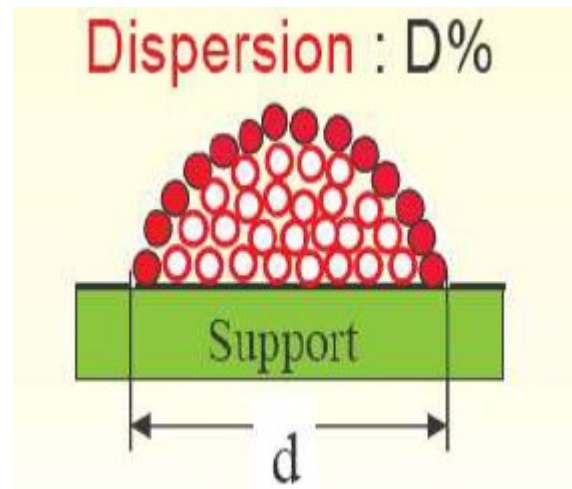

Number of surface  
atoms

$$D = 100 \frac{N_s}{N_T}$$

Total number of  
atoms

# Chemisorption

- Pulse titration

- Very good correlation can be observed between active surface area by H<sub>2</sub> chemisorption and activity in hydrogenation of ... for classical hydrogenation catalyts (Pt, Pd)

- H<sub>2</sub> chemisorption is **dissociative!**

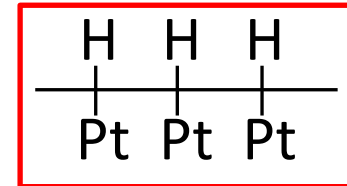

- H–H bond breaks at the time of chemisorption, this is the key to high reactivity (adsorbed **molecular** hydrogen)

- This is Langmuir's chemistry

# Chemisorption

- $X_2$  dissociative chemisorption (detour)

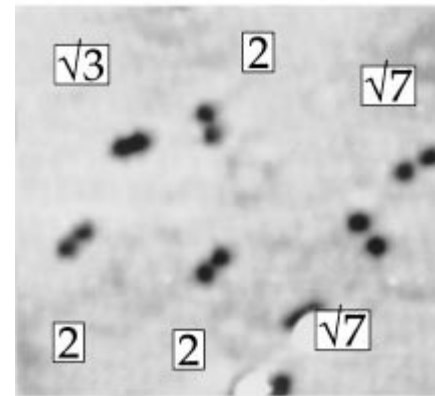
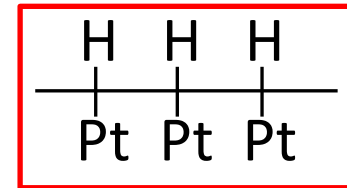
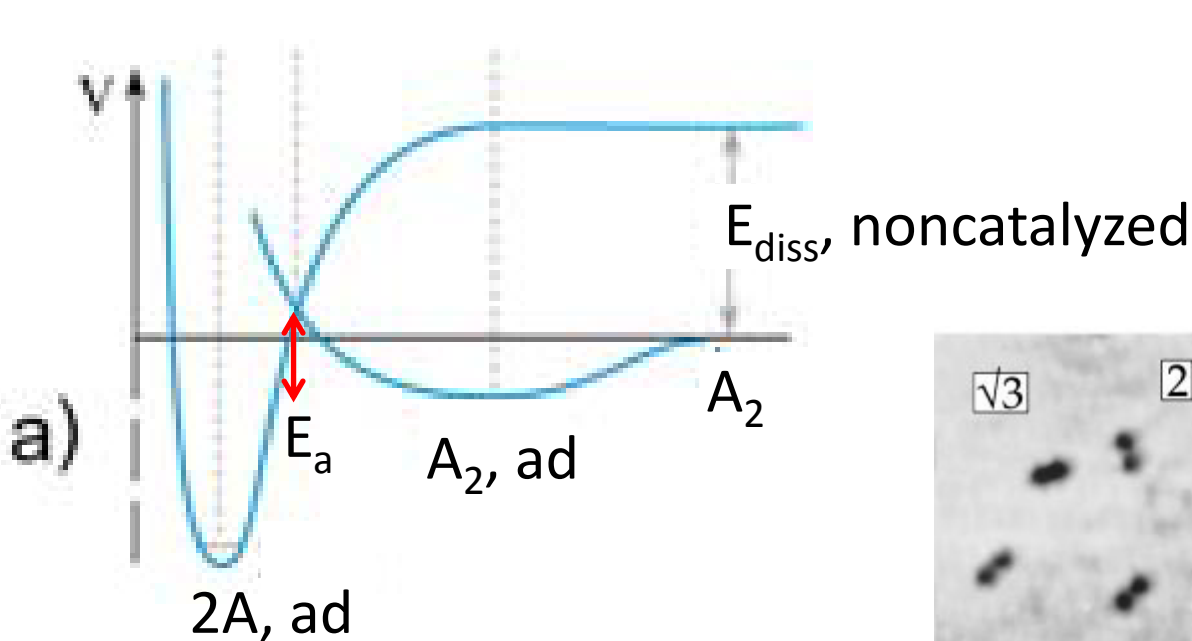

„Hot“ O atoms  
Lifetime  $10^{-13}$  s

$O_2$  adsorption on Pt(111) surface @165 K  
O–O in  $O_2 = 1.2\text{\AA}$ , here much longer



# Chemisorption

- Pulse titration

- Very good correlation can be observed between active surface area by H<sub>2</sub> chemisorption and activity in hydrogenation of ... for classical hydrogenation catalyts (Pt, Pd)

- BUT

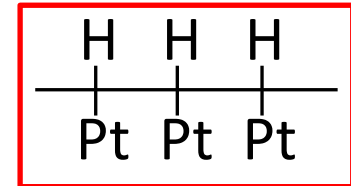

- Example: methanol synthesis over Cu NPs

- $\text{CO}_2 + 2 \text{H}_2 \rightarrow \text{CH}_3\text{OH}$

# Chemisorption

- Example: methanol synthesis over Cu NPs

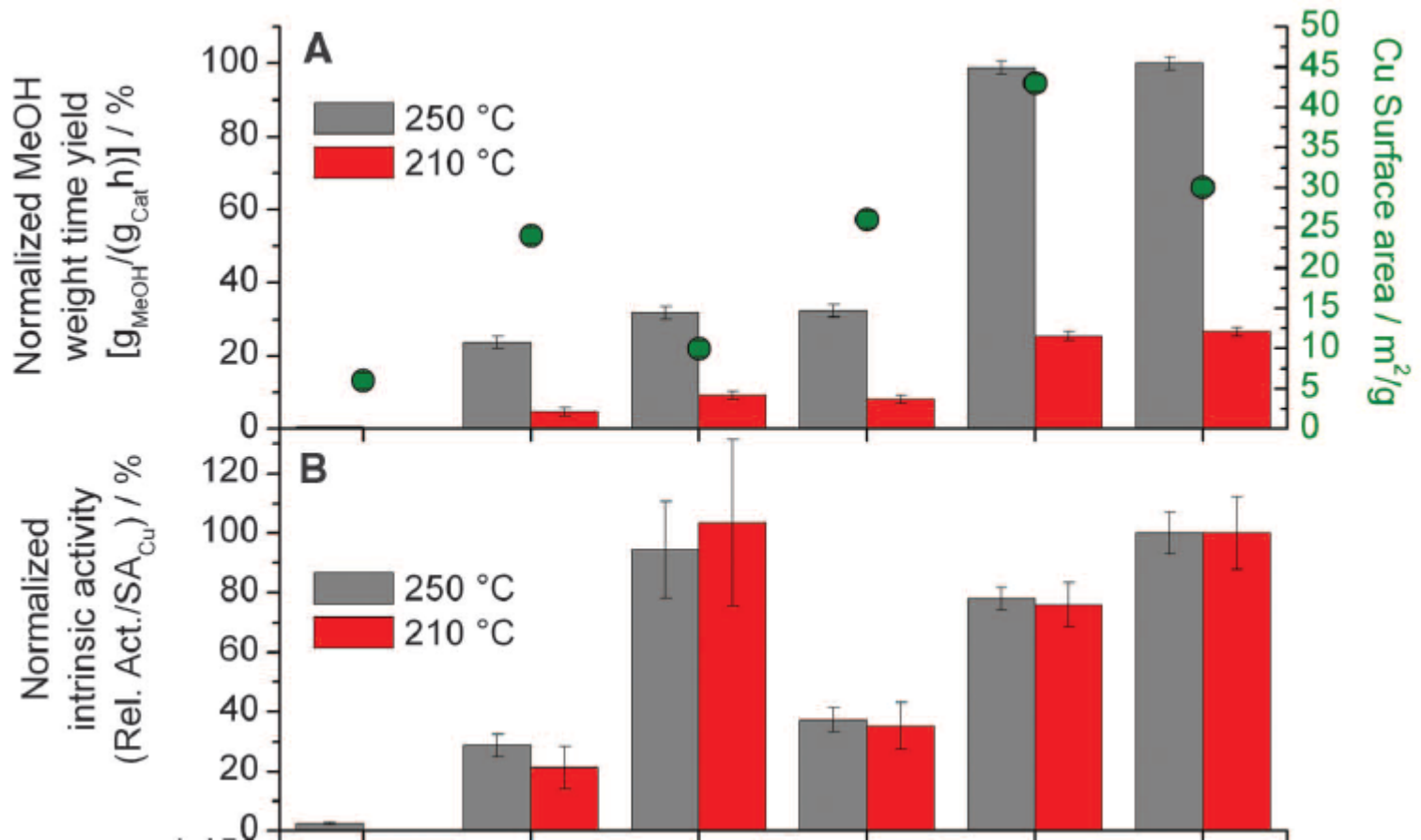

# Chemisorption

- Example: methanol synthesis over Cu NPs

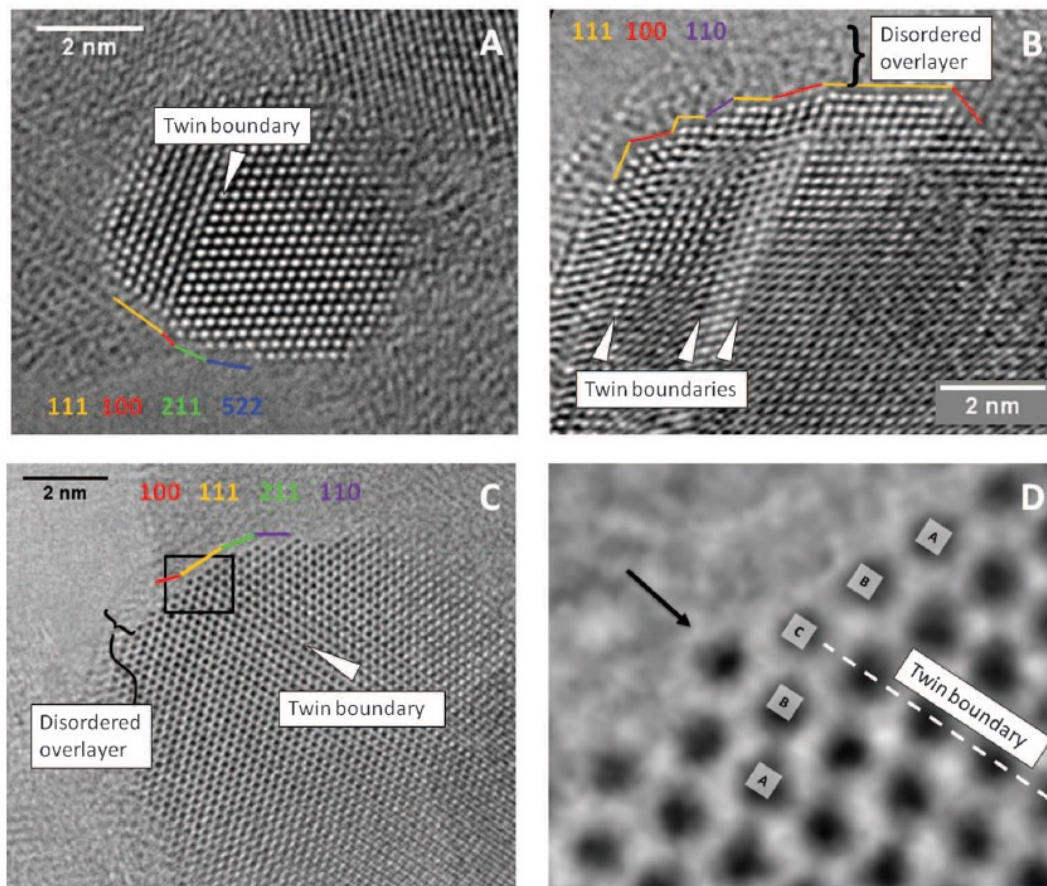

**Fig. 3.** (A to D) Aberration-corrected HRTEM images of Cu particles in the conventionally prepared, most-active Cu/ZnO/Al<sub>2</sub>O<sub>3</sub> catalyst. (D) is a close-up of the marked area in (C).

# Chemisorption

- Example: methanol synthesis over Cu NPs

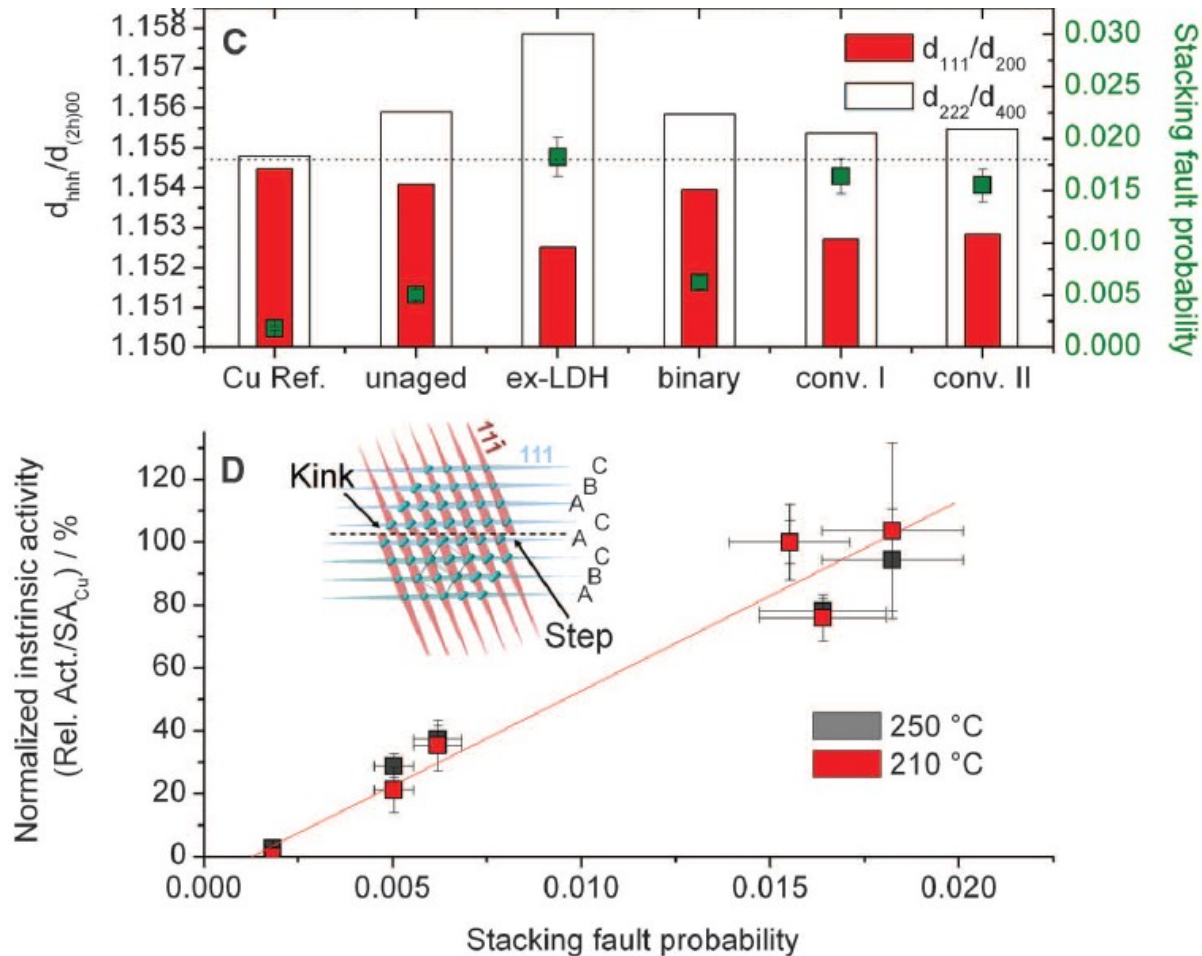

# Chemisorption

- Pulse titration

- **Homework**

- Silver (2.2 wt% on silica)

- Surface reaction:

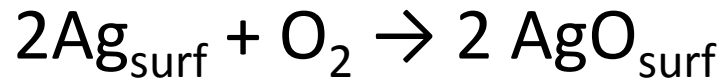

@T = 170 C (no bulk oxidation!)

- $m_{\text{sample}} = 0.5021 \text{ g}$

$V_{\text{pulse}} = 0.00925 \text{ cm}^3 \text{ O}_2 @ \text{RT} @ 1 \text{ atm}$

Max TCD signal = 0.022

- D = ?

Pulse	TCD signal
#1	0
#2	0
#3	0
#4	0
#5	0
...	...
#28	0
#29	0
#30	0.002
#31	0.005
#32	0.011
#33	0.016
#34	0.019
#35	0.021
#36	0.022

# Chemisorption

- Adsorption of IR (NMR) active molecules
  - Pyridine and its derivatives
  - CO
  - Trialkylphosphine oxides
  - ...

# Chemisorption

- Adsorption of IR (NMR) active molecules
  - Number of sites
    - Lambert-Beer law
  - Strength of sites
    - Desorption under vacuum at different temperatures
  - Nature of sites
    - Different vibration modes

# Chemisorption

- Adsorption of IR (NMR) active molecules
- Example: pyridine adsorption on an acid catalyst

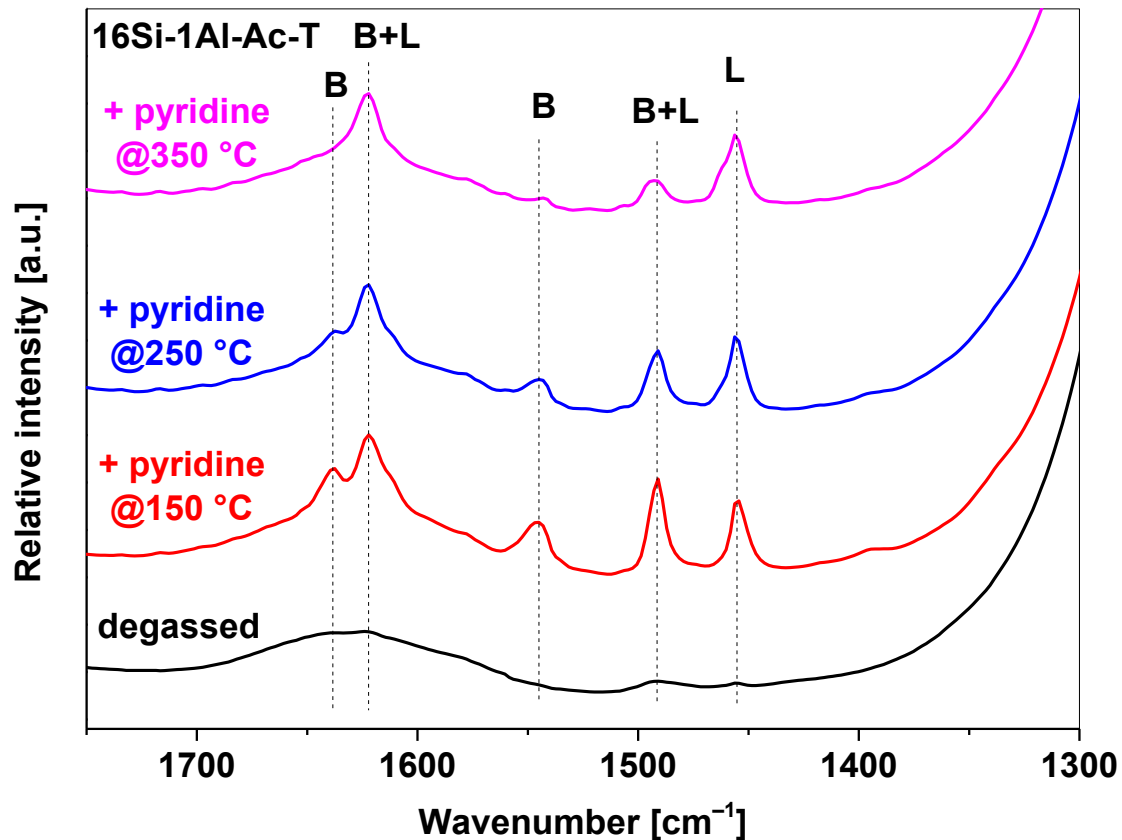



# Chemisorption

- Adsorption of IR (NMR) active molecules
- Example: CO adsorption on MgO, a catalyst that activates methane for oxidation, ideal products are ethane and ethylene
  - $2 \text{CH}_4 + 0.5 \text{O}_2 \rightarrow \text{C}_2\text{H}_6 + \text{H}_2\text{O}$
  - $2 \text{CH}_4 + \text{O}_2 \rightarrow \text{C}_2\text{H}_6 + 2 \text{H}_2\text{O}$

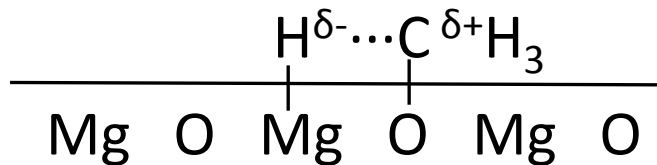

# Chemisorption

- Example: CO adsorption on MgO

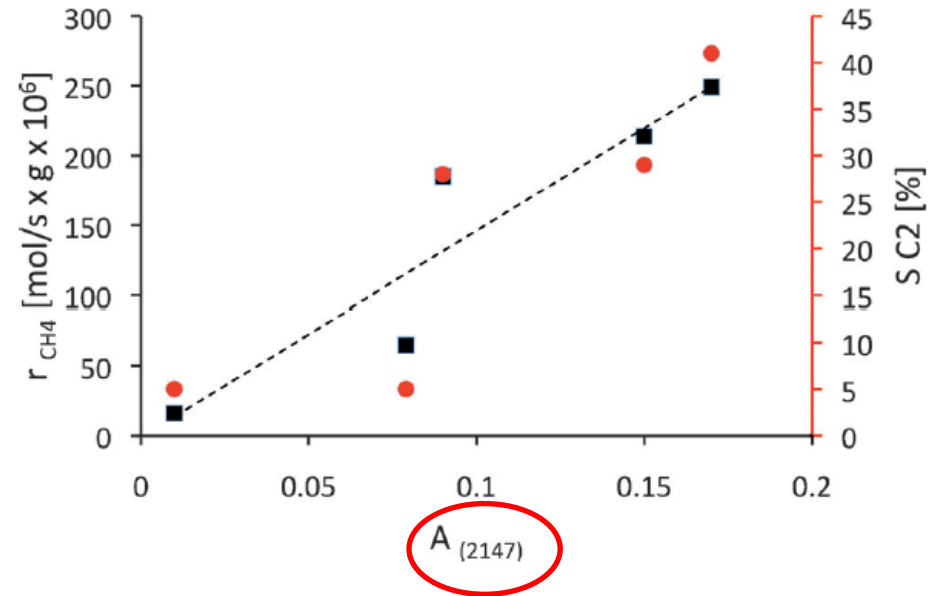
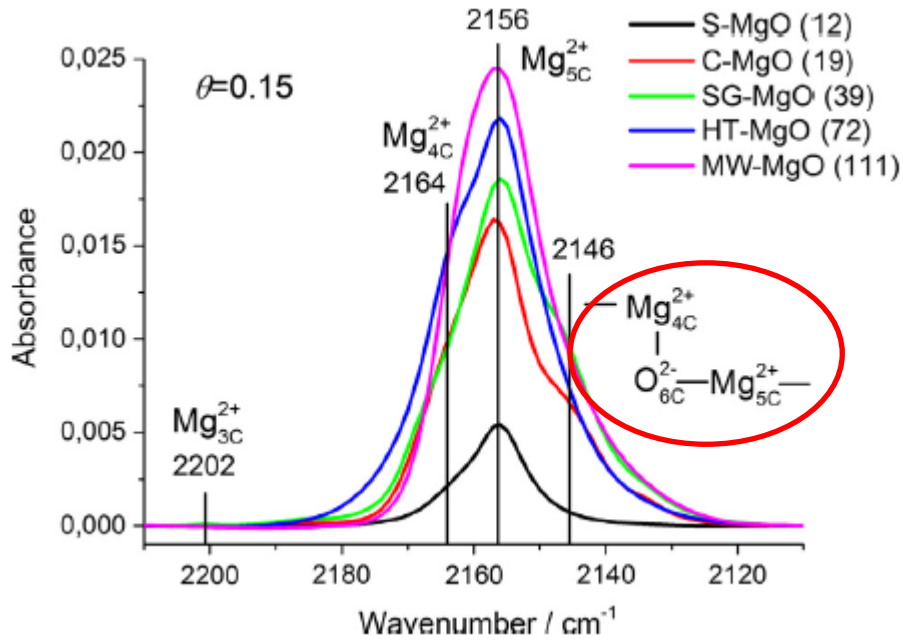

# Chemisorption

- Example: CO adsorption on MgO

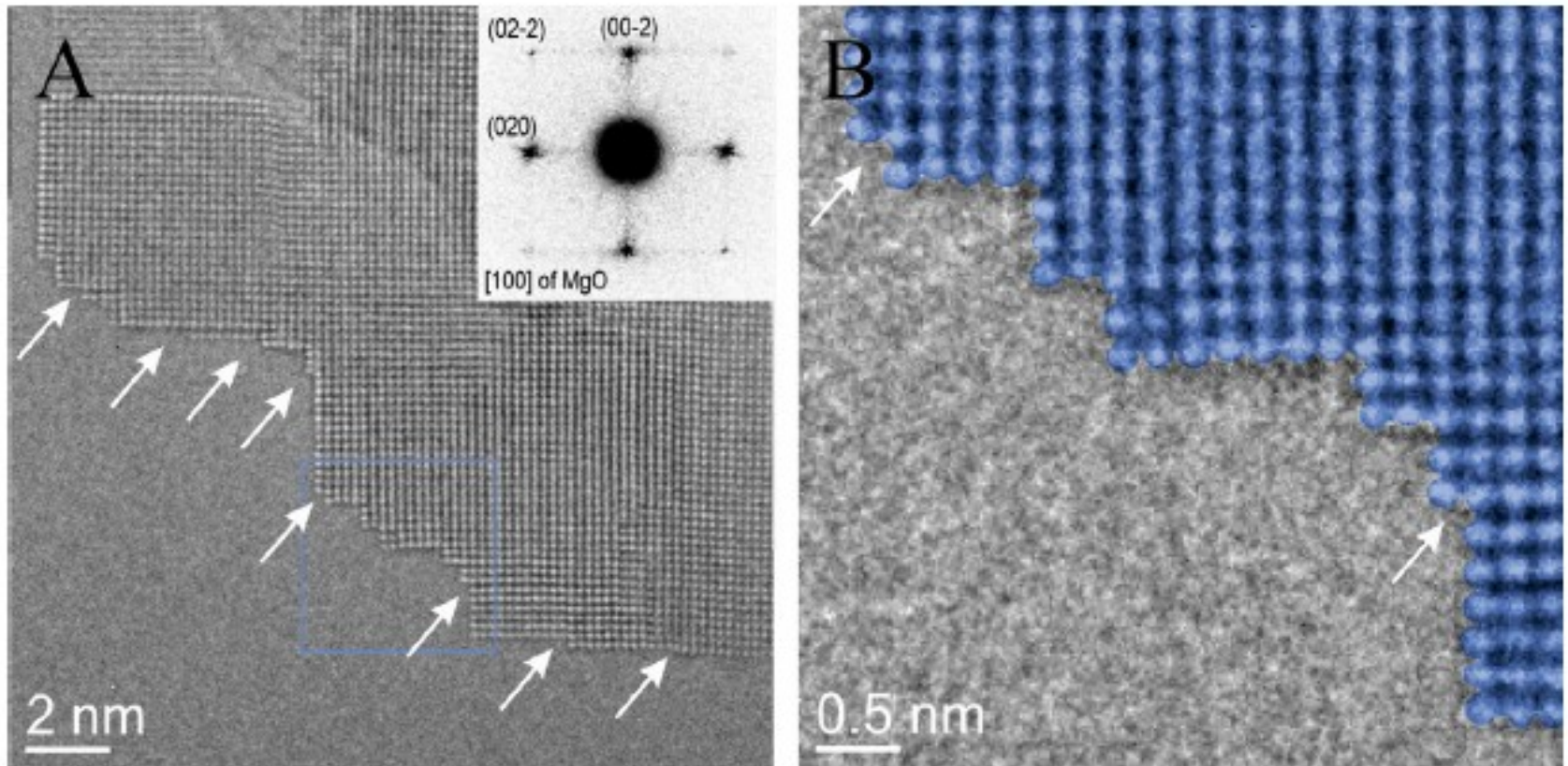

# Chemisorption

- Example: CO adsorption on MgO
- Single step edge is the active site
  - Good correlation between integral of absorption band at  $2147\text{ cm}^{-1}$  and catalytic activity
  - Band at  $2147\text{ cm}^{-1}$  represents single step edge
  - Au atoms selectively deposits on single step edges (observed by HR-TEM) = catalyst poisoning, active site „titration“

# ToF-SIMS

- Time of flight secondary ion mass spectrometry
- Catalyst surface bombarded by „primary“ ions (e.g.  $\text{Bi}_5^+$ )
- Surface atoms (top  $\approx 1$  nm) expelled by this bombardment forming charged clusters = secondary ions created
- Analysis of secondary ions gives us information about catalyst surface

# ToF-SIMS

- Surface composition
  - $\text{AlO}_2^-$  is a function of Al concentration in top 1 nm
  - $\text{AlSiO}_3^-$  is a mixed Al-Si cluster (good Al dispersion)
  - $\text{Al}_2\text{O}_4^-$  signifies badly dispersed Al species

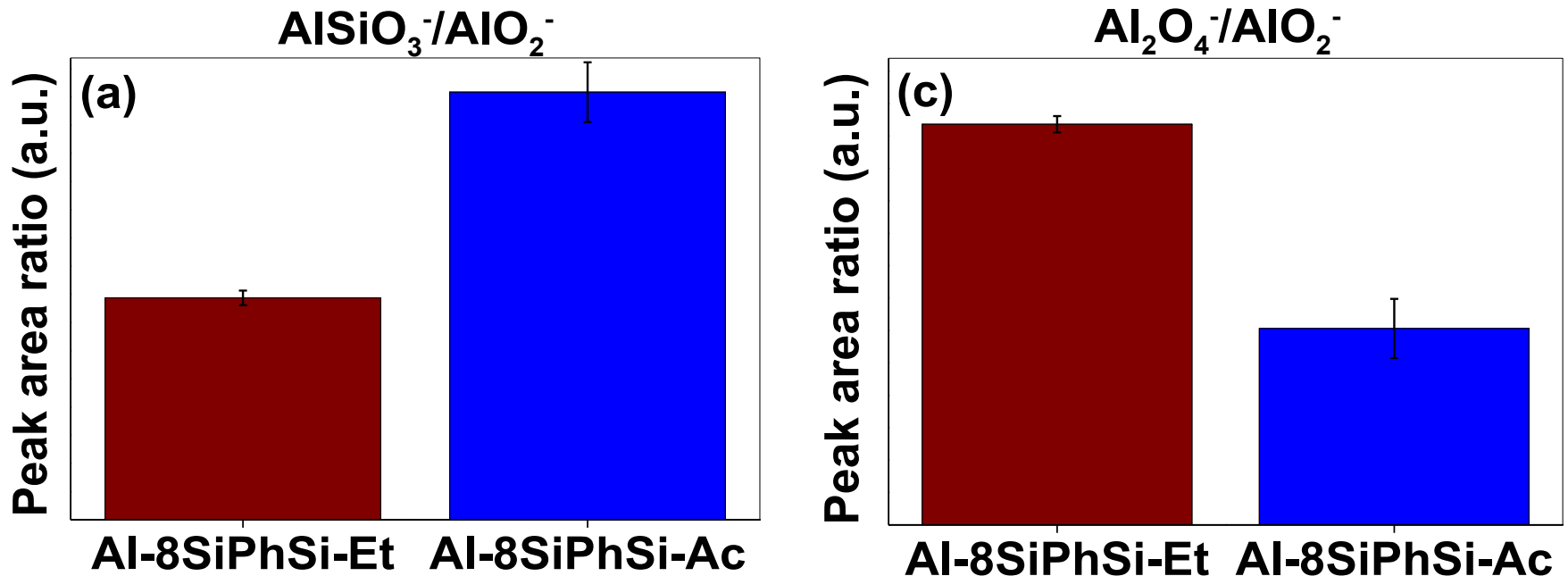

# Catalyst characterization

- Outline
  - DRUV
  - **XPS**
  - XANES & EXAFS
  - **Chemisorption**
  - **ToF-SIMS**