

Lecture on mass spectrometry

Lenka Zajíčková (Faculty of Science MU & CEITEC BUT)

1. Introduction

- 1.1 Principles of Mass Spectrometry
- 1.2 Terminology
- 1.3 Parts of Mass Spectrometer
- 1.4 Applications

2. Ion sources

- 2.1 Ionization
- 2.2 Electron ionization
- 2.3 Chemical ionization
- 2.4 SIMS and Fast atom/ion bombardment
- 2.5 Laser desorption ionization and MALDI
- 2.6 Electrospray

} more details in the course F7360
Characterization of surfaces and thin films
spring semester 2022

3. Mass analyzers

- 3.1 Quadrupolar Analyzers
- 3.2 Quadrupole Ion Trap
- 3.3 Time-of-flight Analyzers
- 3.4 Magnetic and Electromagnetic Analyzers

4. Detectors

- 4.1 Photographic Plate & Faraday Cup
- 4.2 Electron multipliers
- 4.3 Electro-Optical Ion Detectors

1. Introduction

Literature

- E. de Hoffmann and V. Stroobant, Mass Spectrometry: Principles and Applications, Wiley 1999
- J. H. Gross, Mass Spectrometry, Springer 2011
- J. Benedikt, A. Hecimovic, D. Ellerweg and A. von Keudell, Quadrupole mass spectrometry of reactive plasmas, J. Phys. D: Appl. Phys. 45 (2012) 403001 (23pp)

1. Introduction

Mass spectrometry (MS) is an analytical tool measuring the **mass-to-charge ratio (m/z)** of ions created from a sample. These measurements can be used to determine:

- Molecular weight of the sample components
- Molecular formula
- Partial pressure of components
- Structure (from fragmentation fingerprint)
- Isotopic incorporation / distribution

1. Introduction

1.1 Principles

The first step in the mass spectrometric analysis of compounds is the production of gas-phase ions of the compound, for example by electron ionization:

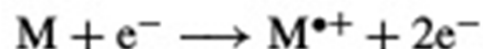

This molecular ion normally undergoes fragmentations. Because it is a radical cation with an odd number of electrons, it can fragment to give either a radical and an ion with an even number of electrons, or a molecule and a new radical cation. We stress the important difference between these two types of ions and the need to write them correctly:

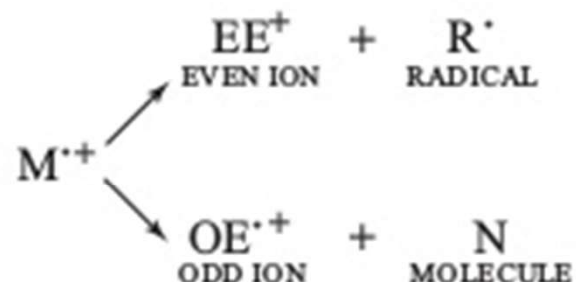

These two types of ions have different chemical properties. Each primary product ion derived from the molecular ion can, in turn, undergo fragmentation, and so on. All these ions are separated in the mass spectrometer according to their mass-to-charge ratio,

1. Introduction

1.2 Terminology

Atoms

consist of nucleons (protons + neutrons) and electrons

- Z - **atomic number (number of protons)**, N – number of neutrons
- chemical properties determined by the number of electrons (atomic number Z)
- physical properties - **mass number A** ($A = Z + N$)

Isotopes

- atom with a determined number of neutrons
- ${}^4\text{He} \Rightarrow 2 \text{ protons} + 2 \text{ neutrons} = \text{mass number } 4$
 ${}^3\text{He} \Rightarrow 2 \text{ protons} + 1 \text{ neutron} = \text{mass number } 3$

A state of ioniz.
 Z X No. of atoms in molecule

Ions

- positively charged \Rightarrow electrons removed from the particle
 He^+ , N_2^+ , CO_2^+ , ${}^{38}\text{Ar}^+$, ${}^{40}\text{Ar}^+$, N_2^{++}
- negatively charged \Rightarrow electrons attached to the particle
 O^- , OH^-

1.2 Terminology

The mass spectrum depends on m/z

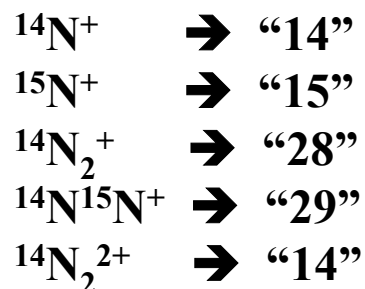

In mass spectrometry, the ion charge q is indicated as **multiples (z)** of the elementary charge e (charge of 1 electron)

$$1 e = 1.602\,177 \times 10^{-19} \text{ C}$$

$$q = z e$$

and the **mass m** is indicated in atomic mass units

$$1 u = 1.660\,540 \times 10^{-27} \text{ kg.}$$

For simplicity, a **new unit**, the **Thomson**, with symbol Th, has been proposed

$$1 \text{ Th} = 1 u/e = 1.036\,426 \times 10^{-8} \text{ kg C}^{-1}$$

Example of mass spectrum - methanol CH_3OH analyzed by electron impact ionization:

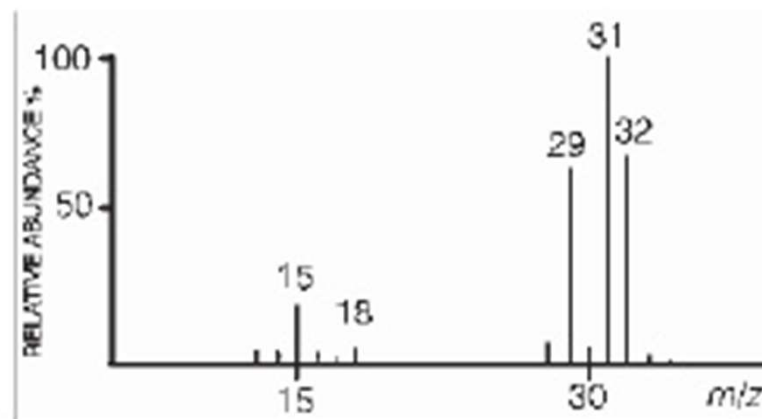

m/z	Relative abundance (%)	m/z	Relative abundance (%)
12	0.33	28	6.3
13	0.72	29	64
14	2.4	30	3.8
15	13	31	100
16	0.21	32	66
17	1.0	33	0.73
18	0.9	34	~ 0.1

1.2 Terminology

Mass

- m - mass in atomic mass units (u) or daltons (Da),
 $1\text{u} = 1\text{ Da} = 1.660\,540 \times 10^{-27}\text{ kg}$
- **u / Da** used in different contexts:
 - **u** – masses referring to the particular isotope of each element as used in mass spectrometry
 - **Da** – mean isotopic masses as generally used in stoichiometric calculations
- The **mass number A** gives rough figure for the atomic mass because of approx. equality of the proton and neutron masses (1.007277u and 1.008665u, respectively) and the relative insignificance of the electron mass ($5.48 \times 10^{-4}\text{u}$).

$\overset{\text{A}}{\text{Z}}\text{X}$ state of ioniz.
No. of atoms in molecule

1.2 Terminology

Mass

- For stoichiometric calculations chemists use the **average mass** calculated using the **atomic weights of atoms composing the molecule** (weighted averages of the atomic masses for the differently abundant isotopes).

Let us consider **CH₃Cl** as an example:

Chlorine atoms: mixtures of two isotopes, **34.968 852** u and **36.965 903** u with relative abundances **75.77%** and **24.23 %**.

The **atomic weight of chlorine** atoms is the weighted average mass:

$$(34.968\ 852 \times 0.7577 + 36.965\ 903 \times 0.2423) = \mathbf{35.453\ Da.}$$

The **average mass of CH₃Cl** is $12.011 + (3 \times 1.00\ 794) + 35.453 = \mathbf{50.4878\ Da.}$

Carbon and hydrogen are also composed of isotopes, but at much lower abundances. They are neglected for this example.

Mass

- ❑ In mass spectrometry, the **nominal mass** or the **monoisotopic mass** is generally used.
- ❑ The **nominal mass** is calculated using the mass of the **predominant isotope** of each element rounded to the nearest integer value that corresponds to the mass number, also called nucleon number.
- ❑ Exact masses of isotopes are not exact whole numbers and differ weakly from the summed mass values of their constituent particles that are protons, neutrons and electrons. These differences, which are called the **mass defects**, are equivalent to the binding energy that holds these particles together. Every isotope has a unique and characteristic mass defect. The **monoisotopic mass** is calculated by using the exact mass of the **most abundant** isotope for each constituent element.

Let us consider again CH_3Cl as an example:

The **monoisotopic mass** is $12.000\ 000 + (3 \times 1.007\ 825) + 34.968\ 852 = 49.992\ 327$ u.

When the mass of CH_3Cl is measured with a mass spectrometer, *two main isotopic peaks* will appear:

first peak $m/z = (34.968852 + 12.000000 + 3 \times 1.007825) = 49.992327$ Th, rounded to m/z **50**.

second peak $m/z = (36.96590 + 12.000000 + 3 \times 1.007825) = 51.989365$ Th, rounded to m/z **52**.

The abundance at this latter m/z value is $(24.23/75.77) = 0.3198$, or 31.98% of that observed at m/z 50. Carbon and hydrogen isotopes are neglected in this example.

The difference between the **average mass**, the **nominal mass** and the **monoisotopic mass** can amount to several Da, depending on the number of atoms (for very high molecular weight) and their isotopic composition. The type of mass determined by mass spectrometry depends largely on the resolution and accuracy of the analyzer.

1. example is human insulin, a protein having the molecular formula $C_{257}H_{383}N_{65}O_{77}S_6$

The **nominal mass** of insulin is **5801 u** using the *integer mass* of the most abundant isotope of each element: 12 u for carbon, 1 u for hydrogen, 14 u for nitrogen, 16 u for oxygen and 32 u for sulfur.

Its **monoisotopic mass** of **5803.6375 u** is calculated using the *exact masses* of the predominant isotope of each element: C=12.0000 u, H=1.0079 u, N=14.0031 u, O=15.9949 u and S=31.9721 u.

Finally, an **average mass** of **5807.6559 Da** is calculated using the *atomic weight* for each element: C=12.011 Da, H=1.0078 Da, N=14.0067 Da, O=15.9994 Da and S= 32.066 Da.

2. example - two alkanes having the molecular formulae $C_{20}H_{42}$ and $C_{100}H_{202}$

Smaller alkane: **nominal mass** is $(20 \times 12) + (42 \times 1) = 282u$, **monoisotopic mass** is $(20 \times 12) + (42 \times 1.007825) = 282.3287u$ rounded to **282.33u**, **average mass** is $(20 \times 12.011) + (42 \times 1.00794) = 282.5535 Da$.

Heavier alkane: **nominal mass** is $(100 \times 12) + (202 \times 1) = 1402u$, **monoisotopic mass** is $(100 \times 12) + (202 \times 1.007825) = 1403.5807u$ rounded to **1403.58u**, **average mass** is $(100 \times 12.011) + (202 \times 1.00794) = 1404.7039 Da$.

*In conclusion, the **monoisotopic mass** is used when it is possible experimentally to distinguish the isotopes, whereas the **average mass** is used when the isotopes are not distinguishable.*

*The use of nominal mass is **not recommended** and should only be used for low-mass compounds.*

Example of mass spectrum:
methanol CH_3OH analyzed by
electron impact ionization:

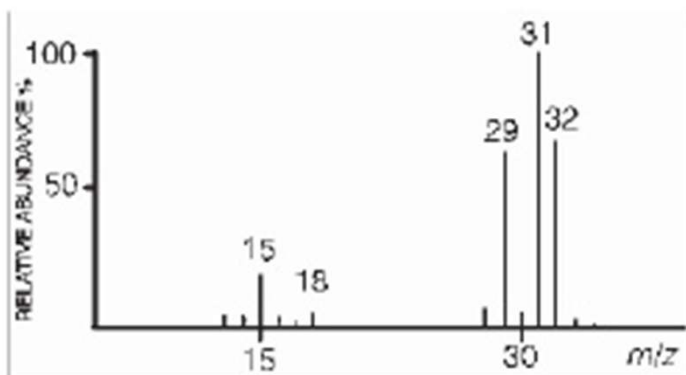

m/z	Relative abundance (%)	m/z	Relative abundance (%)
12	0.33	28	6.3
13	0.72	29	64
14	2.4	30	3.8
15	13	31	100
16	0.21	32	66
17	1.0	33	0.73
18	0.9	34	~ 0.1

- ❑ The most intense peak – **base peak** (normalized 100%)
- ❑ Ions provide information concerning the nature and the structure of their precursor molecule. In the spectrum of a pure compound, the **molecular ion**, if present, appears at the *highest value of m/z* (followed by ions containing **heavier isotopes**) and gives the molecular mass of the compound.
- ❑ The term **molecular ion** refers in chemistry to an ion corresponding to a complete molecule regarding occupied valences. This molecular ion appears at m/z 32 in the spectrum of methanol, where the peak at m/z 33 is due to the presence of the ^{13}C isotope, with an intensity that is 1.1% of that of the m/z 32 peak.
- ❑ The peak at m/z 15 indicates the presence of a **methyl group**. The difference between 32 and 15, that is 17, is characteristic of the loss of a neutral mass of 17 Da by the molecular ion and is typical of a **hydroxyl group**.
- ❑ The **peak at m/z 16** could formally correspond to ions CH_4^+ , O^+ or even $\text{CH}_3\text{OH}^{2+}$, because they all have m/z values equal to 16 at low resolution. However, O^+ is unlikely to occur, and a doubly charged ion for such a small molecule is not stable enough to be observed.

1. Introduction

1.3 Parts of Mass Spectrometer

A mass spectrometer is an apparatus which

- ❑ produces a beam of gaseous ions from a sample - **sample introduction system + ion source**,
- ❑ sorts out the resulting mixture of ions according to their mass-to-charge ratio m/z – **mass analyzer**
- ❑ provides output signals which are measures of the relative abundance of each ionic species present – **detector + recorder**

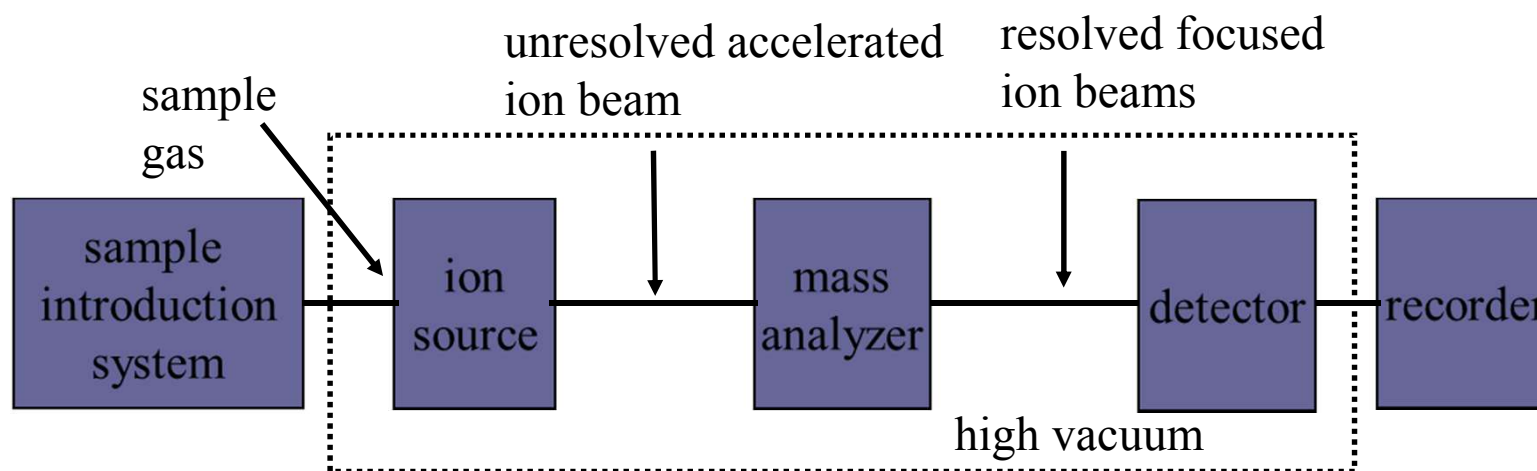

1. Introduction

1.4 Applications

Typical applications are:

- leak detection in vacuum systems
- mass-selective leak testing of serial production components in the automotive industry
- determination of gas-specific desorption and adsorption rates of materials for vacuum system components
- partial pressure measurements in high vacuum systems
- quantitative determination of the composition and purity of process gases
- monitoring of the gas composition in vacuum coating processes
- end point determination in vacuum etching
- analyses of complex mixtures or compounds
- analyses of complex reactions on the surface of solid bodies
- investigation of biochemical substance transformations
- mass-resolved determination of neutral particles and ions in plasma processes (in this case, it can be coupled with the energy resolved analysis of ions)

2. Ion sources 2.1 Ionization

Ionization

Although both positive and negative ions can be studied by mass spectrometry, the majority of instruments are used to investigate *positive ions* because in most ion sources they are produced in larger number (approx. 10^3 x) than negative ions.

The **first ionization potential** – a valence e^- from the highest occupied atomic or molecular orbit is removed to form the corresponding **atomic or molecular ion (parent ion)** in its ground state. To remove 2nd, 3rd etc. electron additional energy is needed (**2nd, 3rd, ... ionization potentials**).

- by electron impact

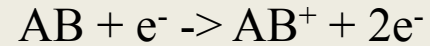

- by photon

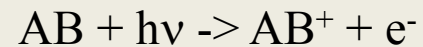

ultraviolet light, lasers (multi-photon absorption), synchrotron radiation

- by impact of high mass particle

such as ion – charge exchange

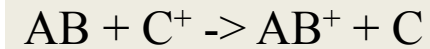

– chemical ionization

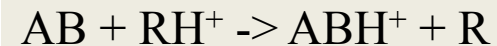

such as fast neutral



such as metastable (Penning ionization)

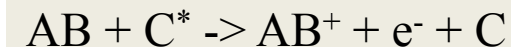

2.1 Ionization – problem of collisions

Collisions would produce a deviation of the trajectory and the ion would lose its charge against the walls of the instrument. On the other hand, ion–molecule collisions could produce unwanted reactions and hence increase the complexity of the spectrum.

According to the kinetic theory of gases, the *mean free path* L is given by
$$L = \frac{1}{\sigma n} = \frac{kT}{\sigma p}$$

where k is the Boltzmann constant, T is the temperature, p is the pressure and σ is the collision cross-section (in m^2). We can approximately assume $\sigma = \pi d^2/4$ where d is the sum of the diameters of the colliding particles.

Electron – neutral collisions: $d = a$, *i.e.* estimated as the diameter of molecule a , $\sigma = \pi a^2/4$

Ion – neutral collisions: $d = 2a$, *i.e.* $\sigma = \pi a^2$ and the movement of “target” molecules has to be taken into account, thus the mutual speed is $\sqrt{2} g$ rather than g , *i.e.*

$$L = \frac{1}{\sqrt{2}\sigma n}$$

One can approximate the mean free path of an ion under normal conditions in a mass spectrometer ($k=1.38 \times 10^{-21} \text{ JK}^{-1}$, $T \approx 300 \text{ K}$, $\sigma \approx 45 \times 10^{-20} \text{ m}^2$) using the following equations where L is in cm and pressure p is in Pa:

$$L = \frac{0.66}{p}$$

1 pascal (Pa) = 1 newton (N) per m^2

1 bar = $10^6 \text{ dyn cm}^{-2} = 10^5 \text{ Pa}$

1 millibar (mbar) = $10^{-3} \text{ bar} = 10^2 \text{ Pa}$

1 microbar (μbar) = $10^{-6} \text{ bar} = 10^{-1} \text{ Pa}$

1 nanobar (nbar) = $10^{-9} \text{ bar} = 10^{-4} \text{ Pa}$

1 atmosphere (atm) = 1.013 bar = 101 308 Pa

1 Torr = 1 mmHg = 1.333 mbar = 133.3 Pa

1 psi = 1 pound per square inch = 0.07 atm

- ❑ In a mass analyzer working with defined ion trajectories, the **mean free path should be at least 1 m** and hence the maximum pressure should be **$6.6 \cdot 10^{-3}$ Pa**. In the instruments using a high-voltage source, the pressure must be further reduced to prevent the occurrence of discharges. In contrast, some trap-based mass analyzers operate at higher pressure.
- ❑ Producing efficient ionization collisions requires the **mean free path to be reduced to around 0.1 mm, implying at least a 60 Pa** pressure in the **region of the ion source**.
- ❑ Introducing the sample to a mass spectrometer often requires the transfer of the sample at the **atmospheric pressure**.

➡ These large differences in pressure are controlled with the help of an efficient pumping system using mechanical pumps in conjunction with **turbomolecular, diffusion or cryogenic pumps**.

The mechanical pumps allow a vacuum of about $1 \cdot 10^{-1}$ Pa to be obtained. Once this vacuum is achieved, the operation of the other pumping systems allows a vacuum as high as 10^{-8} Pa.

- ❑ Samples are often introduced without compromising the vacuum using **direct infusion** or **direct insertion** methods. For direct infusion, a capillary is employed to introduce the sample as a gas or a solution. For direct insertion, the sample is placed on a probe, a plate or a target that is then inserted into the source through a vacuum interlock.
- ❑ For the sources that work at atmospheric pressure and are known as **atmospheric pressure ionization** (API) sources, introduction of the sample is easy because the complicated procedure for sample introduction into the high vacuum of the mass spectrometer is removed.

2.1 Ionization – overview of different methods

Gas-phase ionization (limited to compounds sufficiently volatile and thermally stable)

Electron ionization: electron impact causing electron ejection or capture (section 2.2)

Chemical ionization: collision with other ions - protonation, deprotonation, adduct formation (section 2.3)

Field ionization: Potential difference 8–12 kV is applied between a filament called the emitter and a counter-electrode (a few mm distant). Gas phase molecules approach the surface of the emitter (positive potential). If the electric field at the surface is sufficiently intense, that is if its strength reaches about $10^7 - 10^8 \text{ V cm}^{-1}$, one of the electrons from the sample molecule is transferred to the emitter by quantum tunneling, resulting in the formation of a radical cation M^+ . This ion is repelled by the emitter and flies towards the negative counter-electrode.

A large number of compounds are thermally labile or do not have sufficient vapor pressure. Molecules of these compounds must be directly extracted from the condensed to the gas phase.

Liquid-phase ion sources: electrospray (sec. 2.6), atmospheric pressure chemical ionization and atmospheric pressure photoionization sources

Solid-state ion sources: matrix-assisted laser desorption ionization (MALDI sec. 2.5), secondary ion mass spectrometry (SIMS, sec. 2.4), plasma desorption and field desorption sources (the analyte is in a non-volatile deposit irradiated by energetic particles or photons that desorb ions near the surface of the deposit)

2. Ion sources

2.2 Electron ionization

widely used in plasma diagnostics and organic mass spectrometry

Works well for many gas-phase molecules but induces extensive fragmentation so that the molecular ions are not always observed.

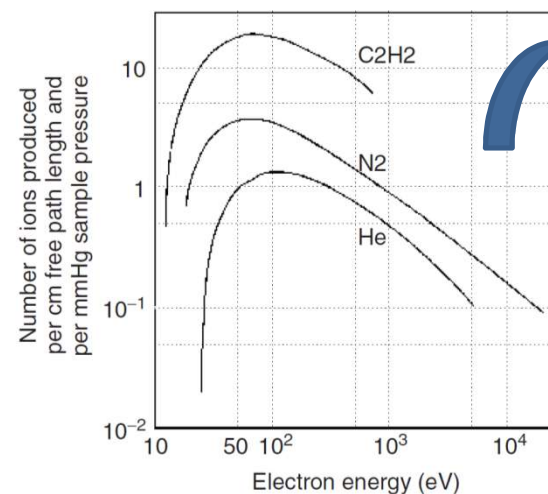
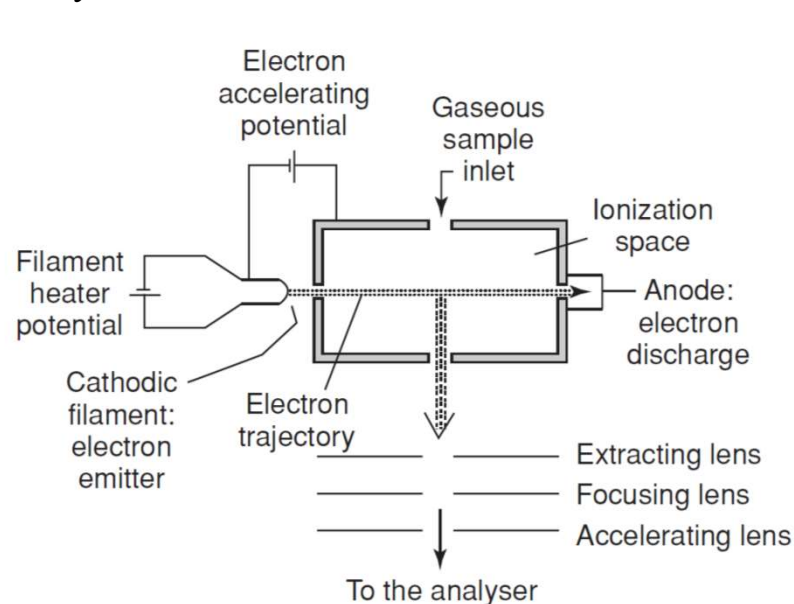

In the case of organic molecules, a wide maximum appears around 70 eV.

$$\lambda = \frac{h}{mv}$$

The wavelength is 0.27 nm for electron kinetic energy of 20 eV and 0.14 nm for 70 eV. When this wavelength is close to the bond lengths, the wave is disturbed. If the energy corresponds to an electronic transition in the molecule, energy can be transferred leading to various electronic excitations. If the transferred energy is equal to the ionization potential it leads to an expel of the electron.

Too high energy leads to too short wavelength of the electron wave – molecules become “transparent”.

2.2 Electron ionization

Ionization

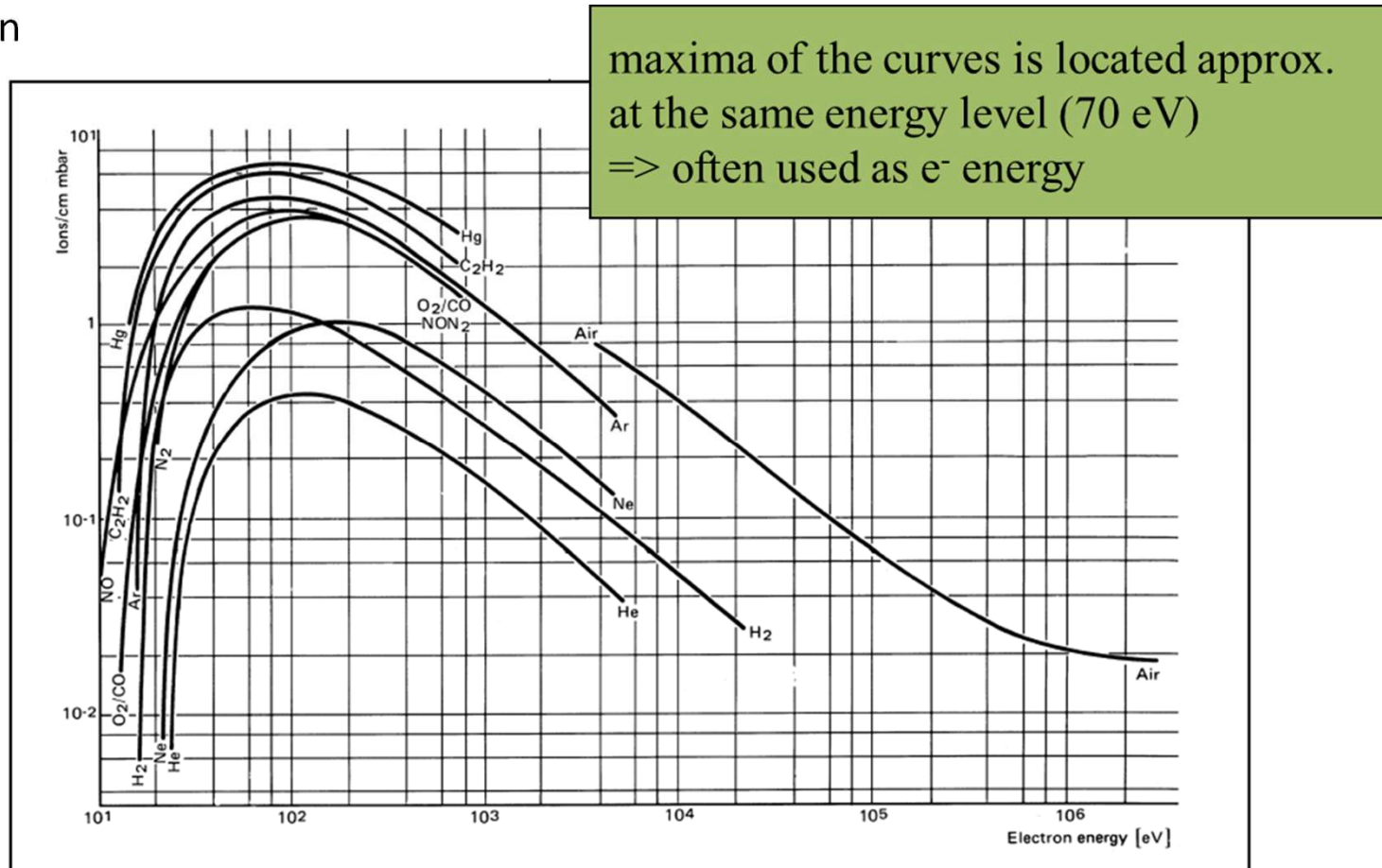

2.2 Electron ionization

Ionization

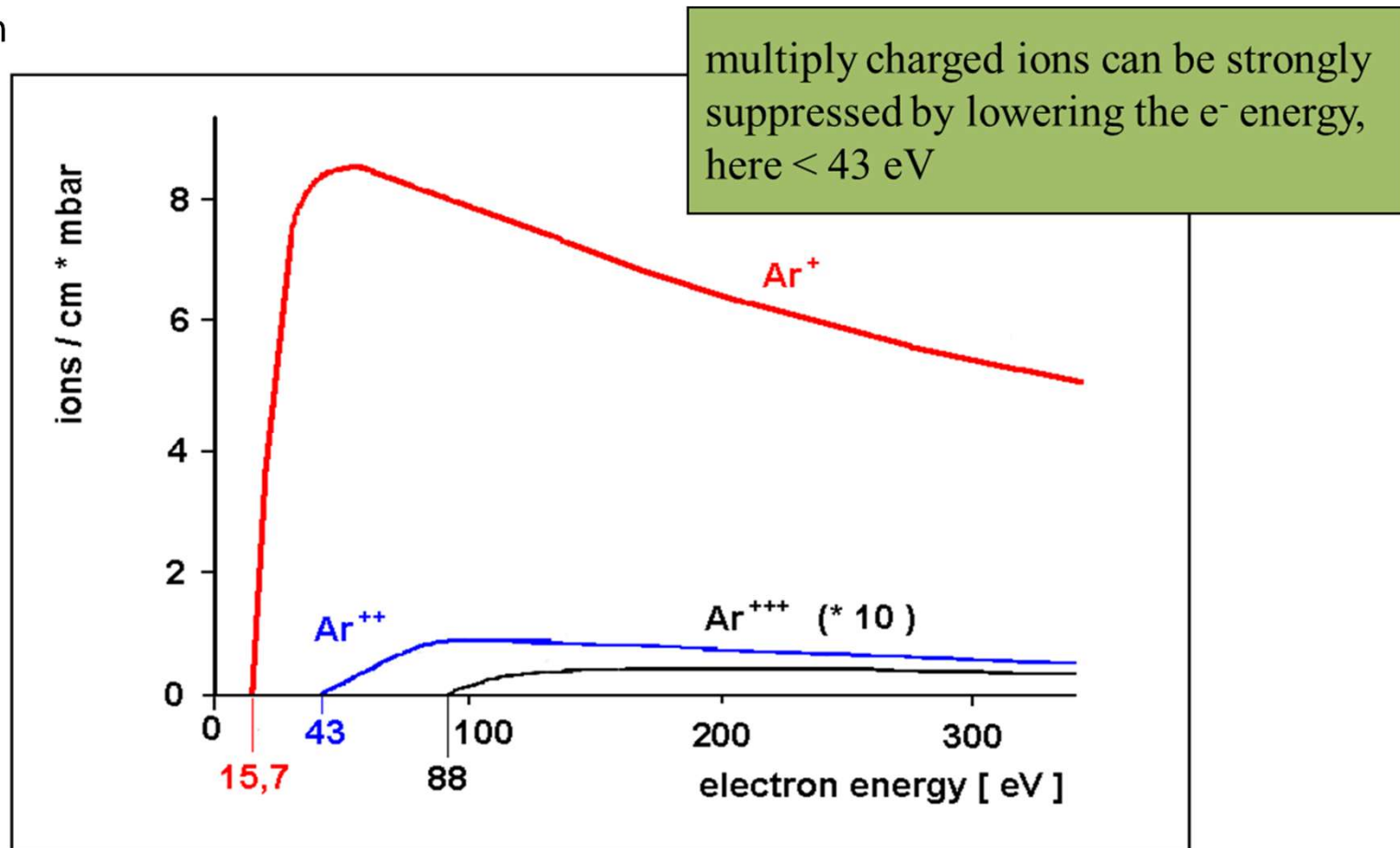

2.2 Electron ionization

Fragmentation during ionization



appearance potential (AE) – minimum energy required for creation of particular fragment ion.

cracking (fractal) pattern – the array of peaks in the complete spectrum of a pure substance.

Peak heights in a spectrum are usually **normalized** by taking the largest peak in the spectrum (**base peak**) as 100. Every chemical compound has its own distinctive cracking pattern (“**fingerprint**”).

Ionization efficiencies and appearance potentials can be used in many ways to study electron impact phenomena:

- *mechanism of ionization and dissociation*
- *calculation of chemical bond strengths*
- *energy states of atoms, molecules, free radicals*
- *theory of mass spectra*

2.2 Electron ionization

Fragmentation during ionization

The fragment distribution of CO₂

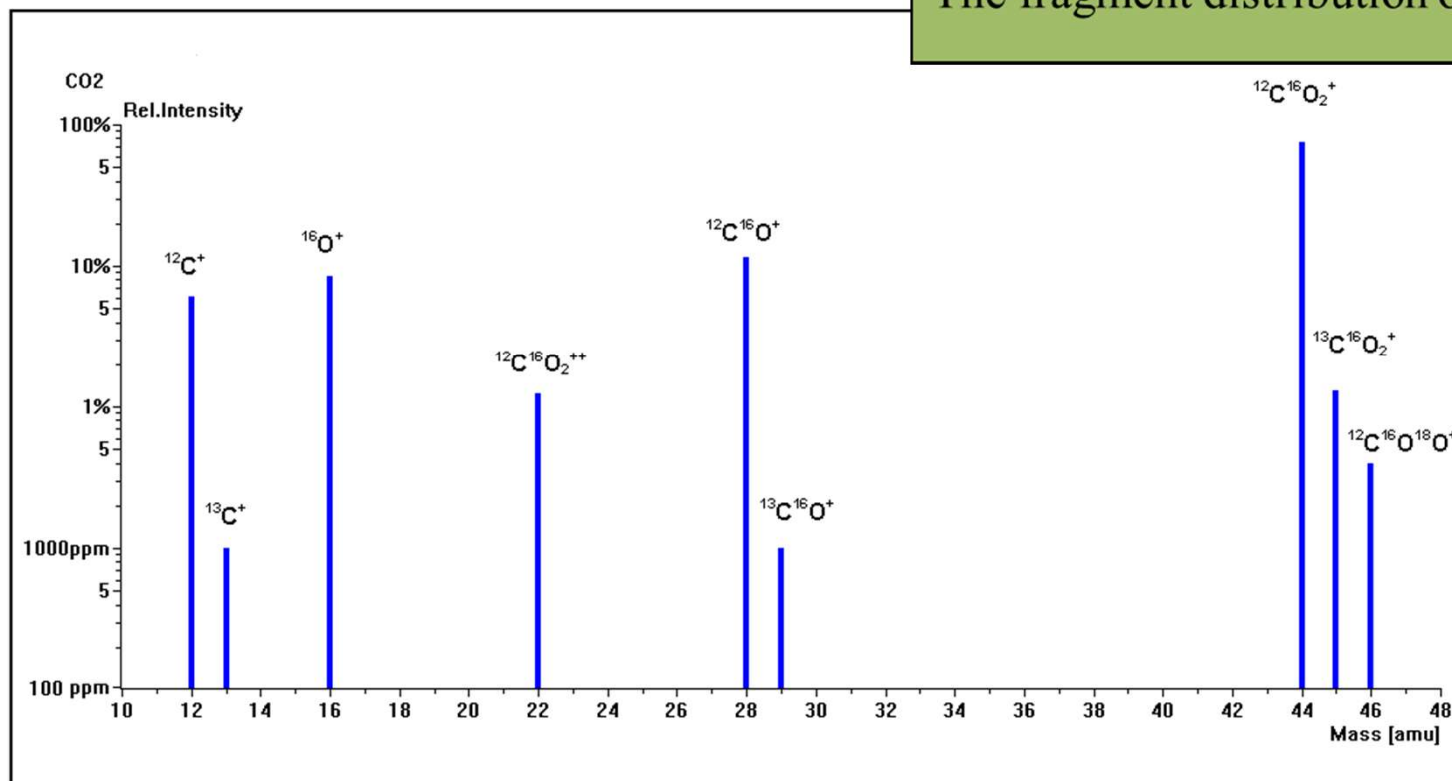

2.2 Electron ionization

Mass spectrum of a gas mixture (recorded at 90 eV ionization energy)

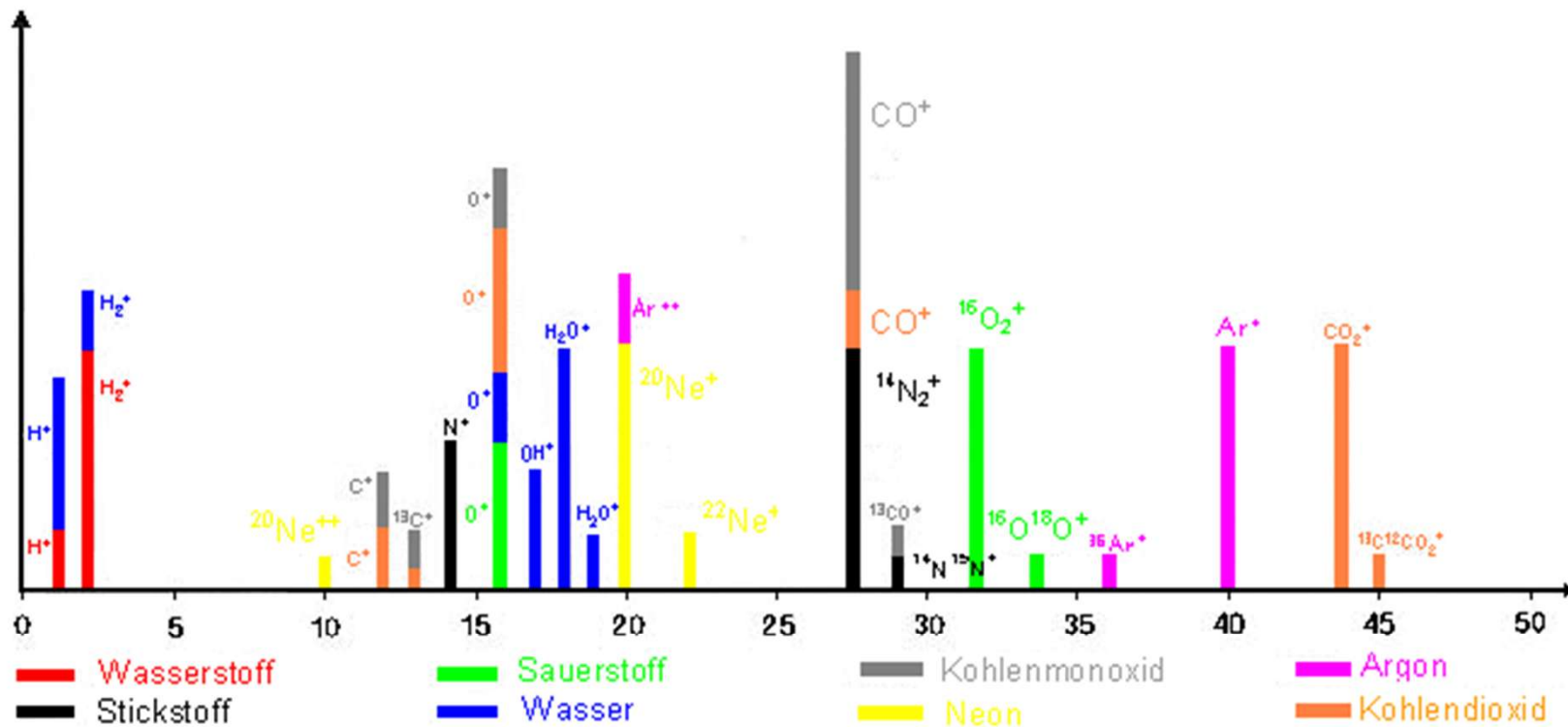

Before carrying out a quantitative gas analysis, the respective calibration factors for each individual component must be determined by feeding suitable calibration gas mixtures with respective non-overlapping components.

2. Ion sources

2.3 Chemical Ionization

CI: production of ions through a collision of the molecule to be analyzed with primary ions (ions of a reagent gas) that are present in the ion source.

Ion–molecule collisions will thus be induced in a definite part of the source. In order to do so, the local pressure has to be sufficient to allow for frequent collisions.

Combined EI and CI source:

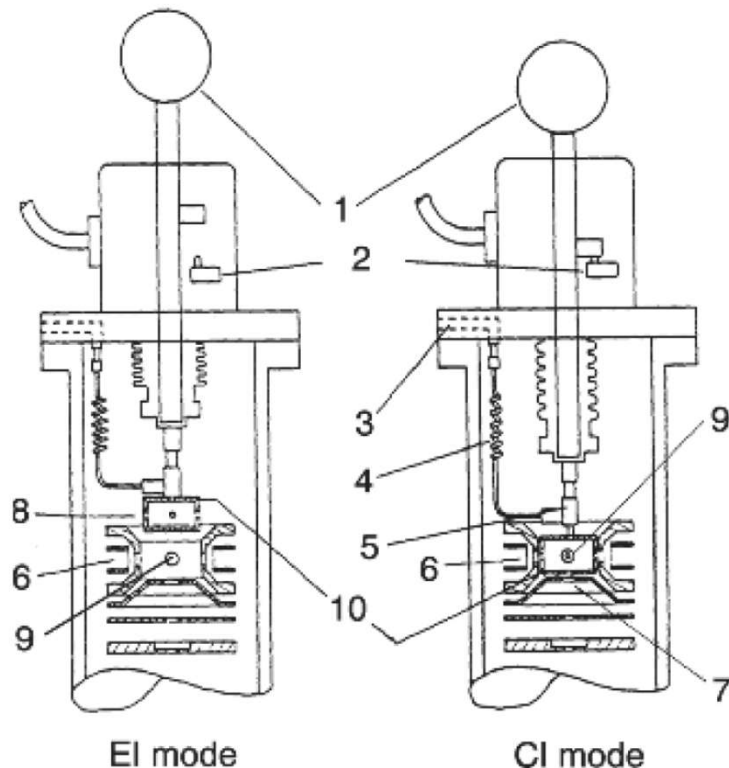

Chemical ionization (CI) is a technique that produces ions with little excess energy. Thus this technique presents the advantage of yielding a spectrum with *less fragmentation* in which the molecular species is easily recognized. Chemical ionization is a lower energy process than electron ionization.

- (1) EI/CI switch; in EI mode, the box serves as a pusher;
- (2) microswitch; (3) entrance for the reagent gas;
- (4) flexible capillary carrying the reagent gas;
- (5) diaphragm; (6) filament giving off electrons;
- (7) path of the ions towards the analyzer inlet;
- (8) hole for the ionizing electrons in CI mode;
- (9) sample inlet;
- (10) box with holes, also named 'ion volume'.

The pumping speed is sufficient to maintain a 60 Pa pressure (mean free path is about 0.1 mm) within the box. Outside, the usual pressure in a source, about 10^{-3} Pa, will be maintained.

2.3 Chemical Ionization

- ❑ Inside the box, the sample pressure amounts to a small fraction of the reagent gas pressure → **electron entering the box preferentially ionizes the reagent gas molecules** through electron ionization.
- ❑ The ions then mostly collide with other reagent gas molecules, thus creating an **plasma** through a series of reactions.
- ❑ Both **positive and negative ions of the analyzed sample will be formed by chemical reactions with ions in the plasma**. This causes **proton transfer reactions, hydride abstractions, adduct formations, charge transfers**, and so on.
- ❑ This plasma will also contain low-energy electrons, called **thermal electrons**. These are either electrons that were used for the first ionization and later slowed, or electrons produced by ionization reactions. These slow electrons may be associated with molecules, thereby yielding **negative ions by electron capture**.

Ions produced from a molecule by the abstraction of a proton or a hydride, or the addition of a proton or of another ion, allow the determination of the molecular mass of the molecules in the sample.

2.3 Chemical Ionization - proton transfer

When analyte molecules M are introduced in the plasma of reagent gas, the **reagent ions** GH^+ can often transfer a proton to the molecules M and produce **protonated molecular ions** MH^+ .

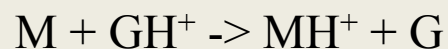

- ❑ It is acid–base reaction: the reagent gas ions GH^+ is Brønsted acid (proton donor) and the analyte molecules M is Brønsted base (proton acceptor).
- ❑ The **proton affinity** (PA) is the negative enthalpy change for the protonation reaction. The observation of protonated molecular ions MH^+ implies that the analyte molecule M has a proton affinity higher than that of the reagent gas: $\text{PA}(\text{M}) > \text{PA}(\text{G})$
- ❑ If the reagent gas has a proton affinity higher than that of an analyte. $\text{PA}(\text{M}) < \text{PA}(\text{G})$, proton transfer from GH^+ to M will be energetically unfavourable.

methane

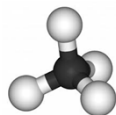

ammonia

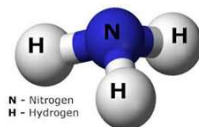

isobutane



- ❑ The energetics of the proton transfer can be controlled by using different reagent gases. The most common reagent gases: **methane** (PA=5.7 eV), **isobutane** C_4H_{10} (PA=8.5 eV) and **ammonia** (PA=9.0 eV).
- ❑ Fragmentation may occur with methane while with isobutane or ammonia the spectrum often presents solely a protonated molecular ion because protonation by these reagent gases is considerably less exothermic.

2.3 Chemical Ionization - proton transfer

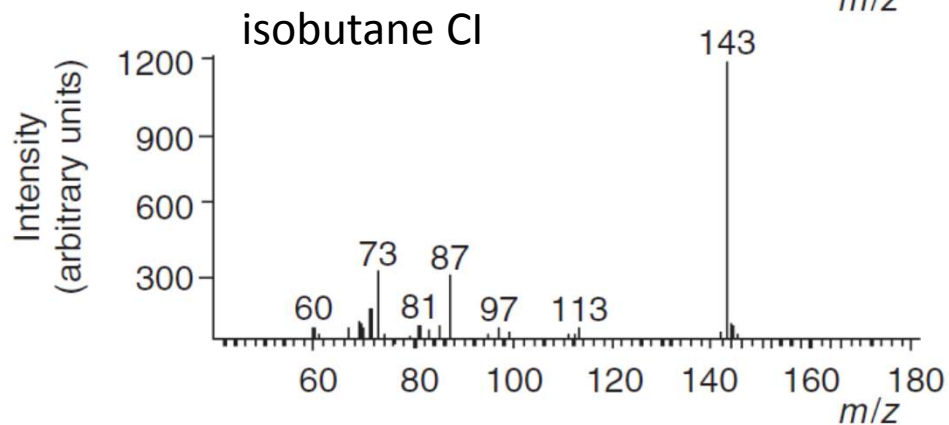
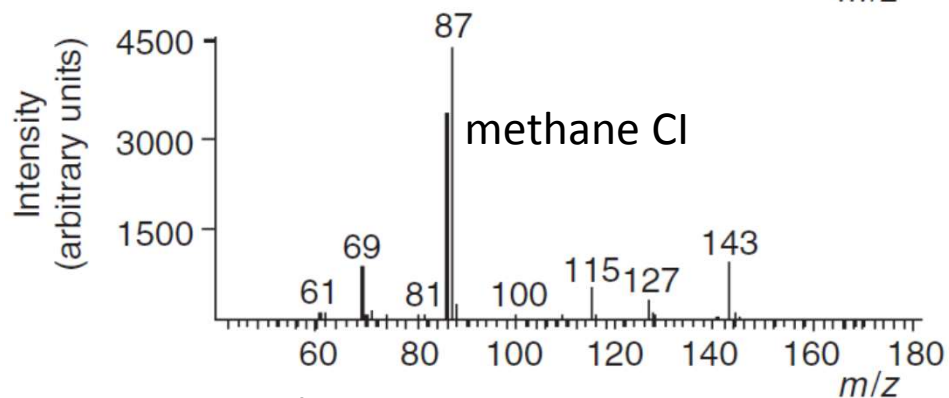
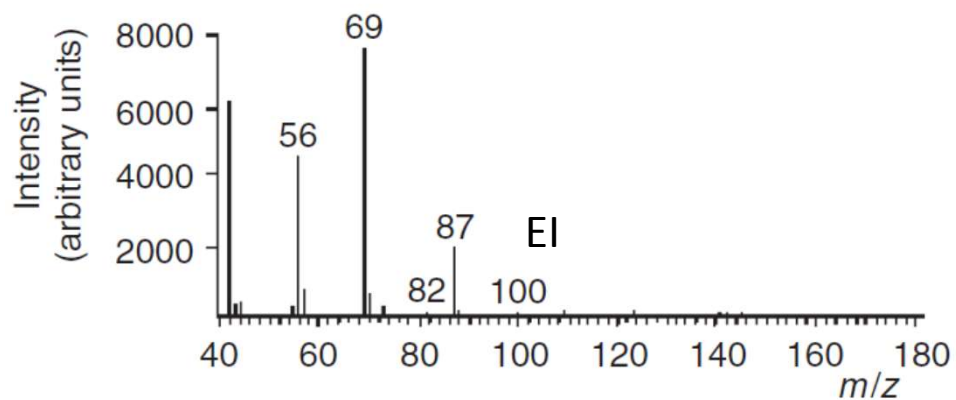

Mass spectra of **butyl methacrylate**
 $C_8H_{14}O_2$ or
 $CH_2C(CH_3)COO(CH_2)_3CH_3$

- The ionization techniques (EI vs CI)
- and the reagent gas (methane vs isobutane)

influence

- the amount of fragmentation and
- the prominence of the protonated molecular ions detected at 143 Th.

2.3 Chemical Ionization – adduct formation

The sample molecule can be associated with a protonated molecular ion MH^+ or a reagent ion F^+ :

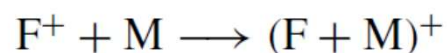
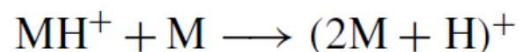

(An **adduct** is a product of a direct addition of two or more distinct molecules, resulting in a single reaction product containing all atoms of all components.)

- ❑ In chemical ionization, all the ions are liable to associate with polar molecules to form adducts. The process is favored by a possible formation of hydrogen bonds.
- ❑ **For the adduct to be stable**, the excess energy must be eliminated, a process which requires a collision with a third partner => **reaction rate is of the third order**
- ❑ A mixture of two species M and N can give rise to associations such as $(MH+N)^+$, $(F+N)^+$, $(F+M)^+$, and so on.
- ❑ It is always useful to examine the peaks appearing beyond the ions of the molecular species of a substance thought to be pure. If some peaks cannot be explained by reasonable associations, a mixture must be suspected.

2.3 Chemical Ionization – adduct formation

Two examples of chemical ionization (isobutane) spectra.

- top spectrum - a pure compound.
- bottom spectrum - a mixture of two compounds with masses 261 and 270. The substance was initially pure but appears as a mixture in the gas phase because it loses either hydrogen cyanide (HCN) or water.

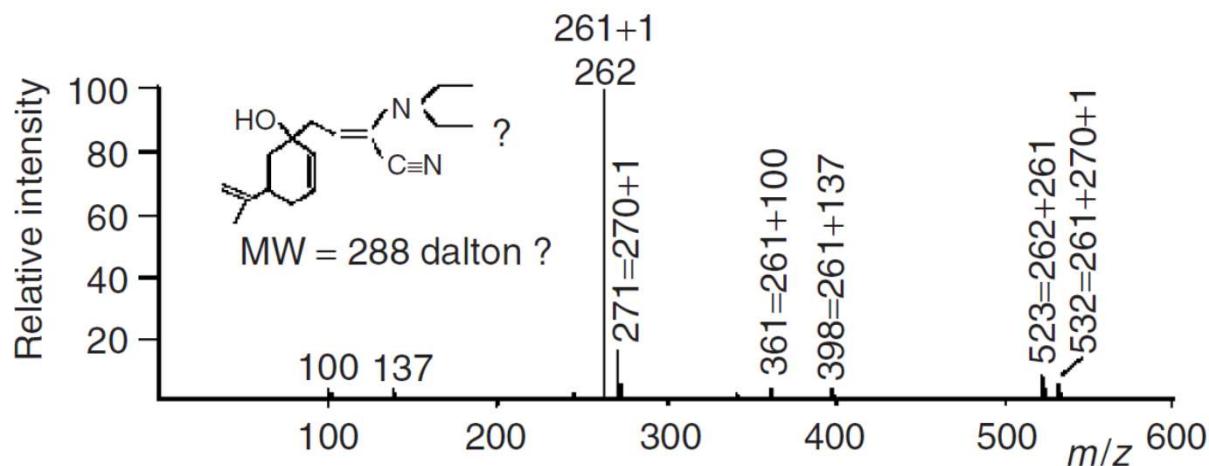
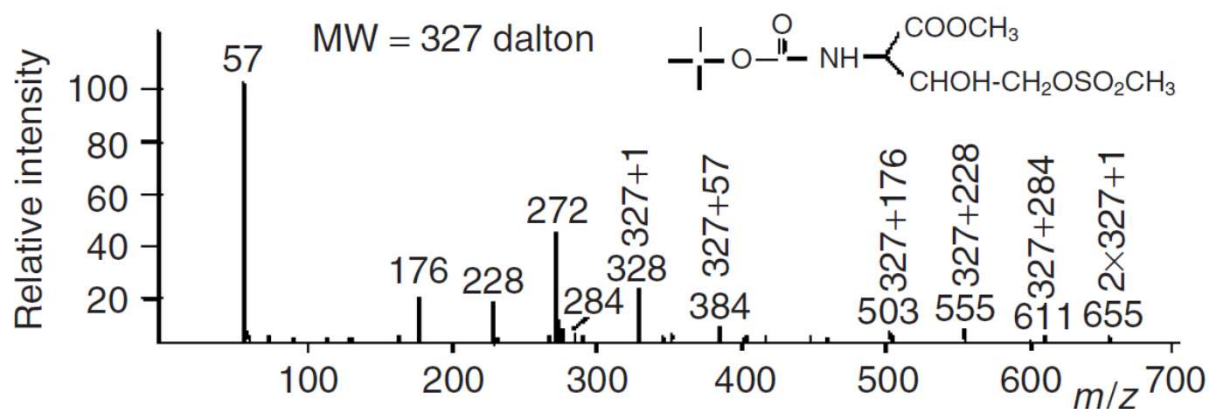

When interpreting the results, one must always keep in mind that a mixture that is observed may result from the presence of several constituents before the vaporization or from their formation after the vaporization.

2.3 Chemical Ionization - charge-transfer CI

Rare gases, nitrogen, carbon monoxide and others with high ionization potential react by charge exchange:

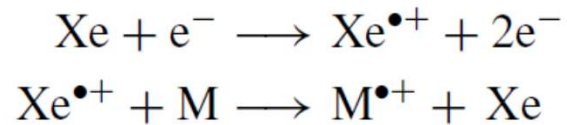

A **radical** cation is obtained, as in EI, but with a smaller energy content. Less fragmentation is thus observed. In practice, it is not used very often.

Repeat the nomenclature:

Radical (more precisely, a free radical) is an atom, molecule, or ion that has unpaired valence electrons.

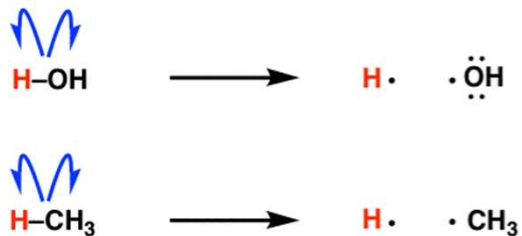

Anion is an ion with more electrons than protons, giving it a net negative charge.

Cation is an ion with fewer electrons than protons, giving it a positive charge.

2.3 Chemical Ionization - negative ion formation

Almost all neutral substances are able to yield positive ions, whereas **negative ion creation requires the presence of acidic groups or electronegative elements**. This allows some selectivity for their detection in mixtures.

Negative ions can be produced by *capture of thermal electrons by the analyte molecule*

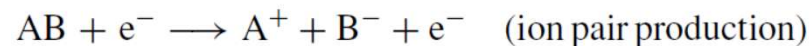

- ❑ The *associative resonance capture* that leads to the formation of negative molecular ions needs electrons in the energy range 0–2 eV.
- ❑ The *dissociative resonance capture* is observed with electrons of 0–15 eV and leads to the formation of negative fragment ions.
- ❑ *Ion pair production* is observed with a wide range of electron energies above 15 eV. It is principally this process that leads to negative ion production under conventional EI conditions. Ion pair production forms structurally insignificant very low-mass ions with a sensitivity that is 3–4 orders of magnitude lower than that for positive ion production.

Any excess of energy from the negative molecular ion as it is formed must be removed by collision. Thus, in CI conditions, the **reagent gas** serves not only for producing thermal electrons but also as a source of molecules for collisions to stabilize the formed ions.

or by *ion–molecule reactions between analyte and ions present in the reagent plasma*. These reactions can be an acid–base reaction or an addition reaction through adduct formation.

2.3 Chemical Ionization - reagent gases

Methane

If methane is introduced into the ion volume through the tube, the primary reaction with the electrons will be a classical EI reaction:

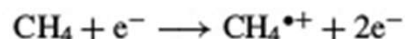

This ion will fragment, mainly through the following reactions:

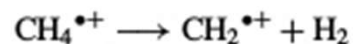
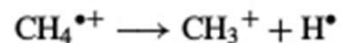

However, mostly, it will collide and react with other methane molecules yielding

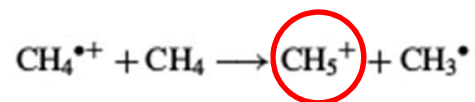

Other ion-molecule reactions with methane will occur in the plasma, such as

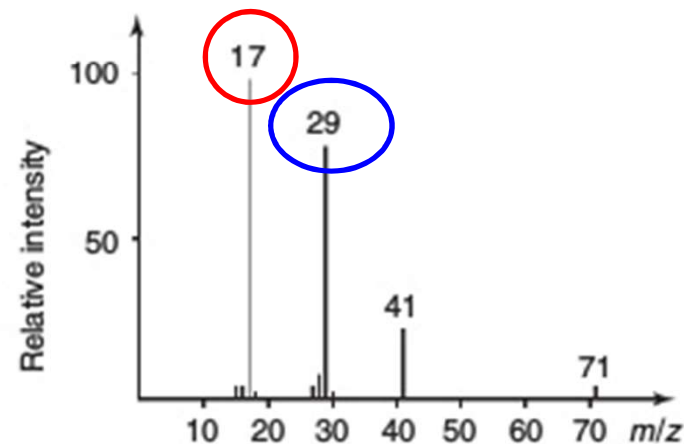
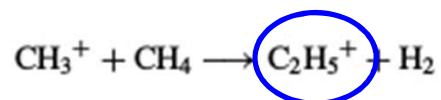

Figure 1.7
Spectrum of methane ionization plasma at 20 Pa. The relative intensities depend on the pressure in the source.

continues on next slide ...

2.3 Chemical Ionization - reagent gases

Methane

A $C_3H_5^+$ ion is formed by the following successive reactions:

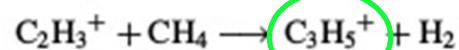
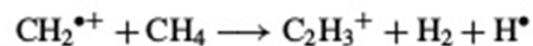

The relative abundance of all these ions will depend on the pressure. Figure 1.7 shows the spectrum of the plasma obtained at 200 μ bar (20 Pa). Taking CH_5^+ , the most abundant ion, as a reference (100%), $C_2H_5^+$ amounts to 83 % and $C_3H_5^+$ to 14 %.

Unless it is a saturated hydrocarbon, the sample will mostly react by acquiring a proton in an acid-base type of reaction with one of the plasma ions, for example

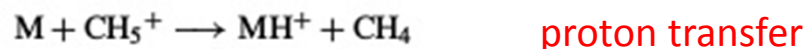

A systematic study showed that the main ionizing reactions of molecules containing heteroatoms occurred through acid-base reactions with $C_2H_5^+$ and $C_3H_5^+$. If, however, the sample is a saturated hydrocarbon RH, the ionization reaction will be a hydride abstraction:

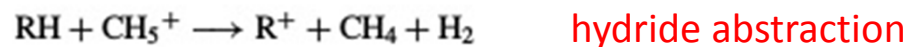

Moreover, ion-molecule adduct formation is observed in the case of polar molecules, a type of gas-phase solvation, for example



The ions $(MH)^+$, R^+ and $(M + CH_3)^+$ and other adducts of ions with the molecule are termed molecular species or, less often, pseudomolecular ions. They allow the determination of the molecular mass of the molecules in the sample.

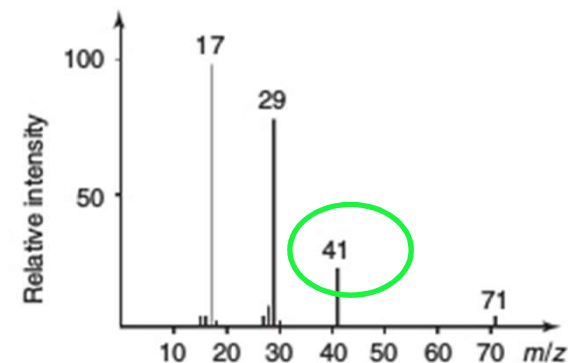
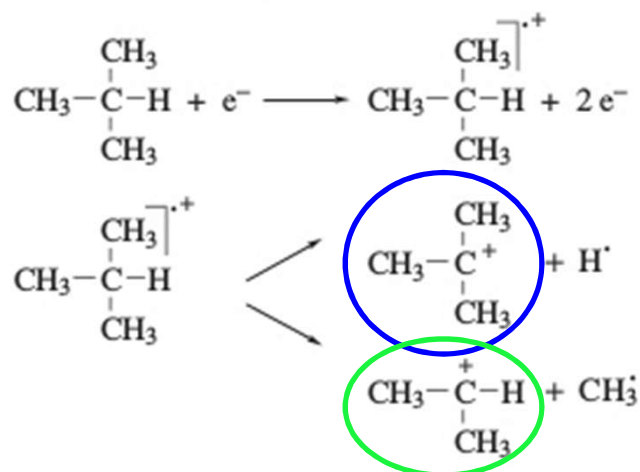

Figure 1.7
Spectrum of methane ionization plasma at 20 Pa. The relative intensities depend on the pressure in the source.

2.3 Chemical Ionization - reagent gases

Isobutane

Isobutane loses an electron upon EI and yields the corresponding radical cation, which will fragment mainly through the loss of a hydrogen radical to yield a *t*-butyl cation, and to a lesser extent through the loss of a methyl radical:



An ion with mass 39 Da is also observed in its spectrum (Figure 1.8) which corresponds to C_3H_3^+ . Neither its formation mechanism nor its structure are known, but it is possible that it is the aromatic cyclopropenium ion.

Here again, the plasma ions will mainly react through proton transfer to the sample, but polar molecules will also form adducts with the *t*-butyl ions $(M + 57)^+$ and with C_3H_3^+ , yielding $(M + 39)^+$ among others.

This isobutane plasma will be very inefficient in ionizing hydrocarbons because the *t*-butyl cation is relatively stable. This characteristic allows its use in order to detect specifically various substances in mixtures containing also hydrocarbons.

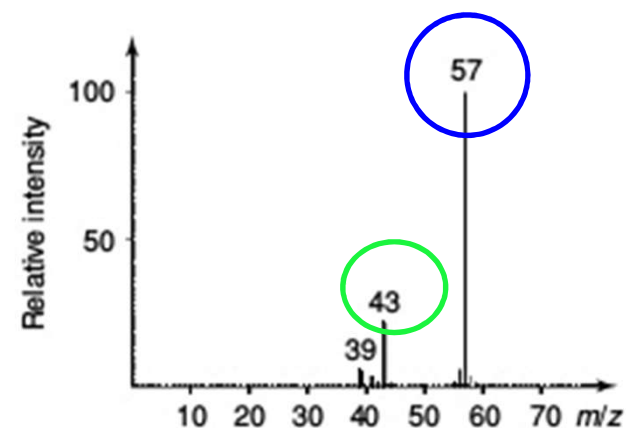
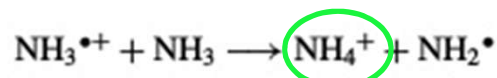

Figure 1.8
Spectrum of the isobutane plasma under chemical ionization conditions at 200 μbar .

2.3 Chemical Ionization - reagent gases

Ammonia

The radical cation generated by EI reacts with an ammonia molecule to yield the ammonium ion and the NH_2^\bullet radical:



An ion with mass 35 Da is observed in the plasma (Figure 1.9) which results from the association of an ammonium ion and an ammonia molecule:

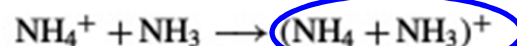

This adduct represents 15 % of the intensity of the ammonium ion at 200 μbar .

In this gas, the ionization mode will depend on the nature of the sample. The basic molecules, mostly amines, will ionize through a proton transfer:

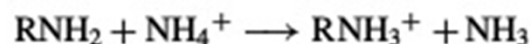

Polar molecules and those able to form hydrogen bonds while presenting no or little basic character will form adducts. In intermediate cases, two pseudomolecular ions $(M + 1)^+$ and $(M + 18)^+$ will be observed. Compounds that do not correspond to the criteria listed above, for example saturated hydrocarbons, will not be efficiently ionized. Alkanes, aromatics, ethers and nitrogen compounds other than amines will not be greatly ionized. Comparing spectra measured with various reagent gases will thus be very instructive. For example, the detection, in the presence of a wealth of saturated hydrocarbons, of a few compounds liable to be ionized is possible, as shown in Figure 1.10.

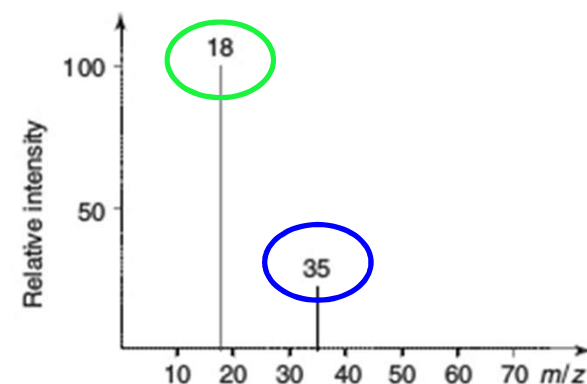

Figure 1.9
Spectrum of an ammonia ionization plasma at 200 μbar .

2. Ion sources

2.4 SIMS and Fast atom/ion bombardment

Secondary ion mass spectrometry (SIMS) analyses the secondary ions emitted when a **surface is irradiated with an energetic primary ion beam**.

- ❑ mostly used with solids and is especially useful to study *conducting surfaces*. High resolution chemical maps are produced by scanning a tightly focused ionizing beam across the surface.
- ❑ **Static SIMS** – low energy beam (less damage),
- ❑ **Dynamic SIMS** – high energy beam (erosion, profiling)

Fast atom bombardment (FAB) and **liquid secondary ion mass spectrometry (LSIMS)**

a **high primary current beam of neutral atoms/molecules (FAB) or ions (LSIMS)** focused on the sample. **The sample must be dissolved in a non-volatile liquid matrix.** *Glycerol is most often used, m-nitrobenzyl alcohol (MNBA) is a good liquid matrix for non-polar compounds, and di- and triethanolamine are efficient, owing to their basicity, in producing negative ions.* Thioglycerol and eutectic mixture of dithiothreitol and dithioerythritol (5:1 w/w), referred to as magic bullet, are alternatives to glycerol.

- ❑ Energetic particles hit the sample solution, inducing a shock wave which ejects ions and molecules from the solution. Ions are accelerated by a potential difference towards the analyzer. These techniques induce little or no ionization. They generally eject into the gas phase ions that were already present in the solution.
- ❑ The neutral atom beam at about 5 keV is obtained by ionizing a compound, most often **argon**, sometimes **xenon**. Ions are accelerated and focused towards the compound to be analysed under several kilovolts
- ❑ Using a ‘**caesium gun**’, one produces a beam of Cs⁺ ions at about 30 keV. It is claimed to give better sensitivity than a neutral atom beam for high molecular weights. However, the advantage of using neutral molecules instead of ions lies in the avoidance of an accumulation of charges in the non-conducting samples.

More details in the course F7360 Charakterizace povrchů a tenkých vrstev
spring semester 2022

2. Ion sources

2.4 SIMS and Fast atom/ion bombardment (contin.)

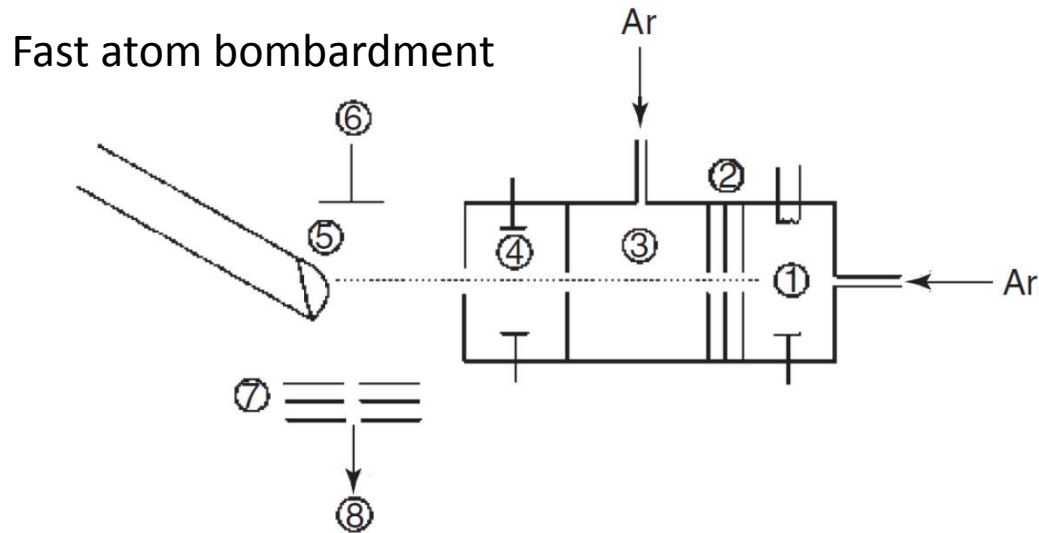

Softer than EI and CI. Ions are produced by bombardment with heavy atoms. Gives $(M+H)^+$ ions and little fragmentation. Good for more polar compounds.

(1) Ionization of argon; the ions are accelerated and focused by the lenses (2). **In (3), the argon ions exchange their charge with neutral atoms, thus becoming rapid neutral atoms.** As the beam path passes between the electrodes (4), all ionic species are deflected. Only rapid neutral atoms reach the sample dissolved in a drop of glycerol (5). The ions ejected from the drop are accelerated by the pusher (6), and focused by the electrodes (7) towards the analyzer (8).

*This method is very **efficient for producing ions from polar compounds** with **high molecular weights**. Ions up to **10 000 Da** and above can be observed, such as peptides and nucleotides. Moreover, it often produces ion beams that can be maintained during long periods of time, sometimes several tens of minutes, which allows several types of analysis to be carried out.*

2. Ion sources

2.5 Laser Desorption Ionization (LDI)

- ❑ **Laser desorption ionization (LDI)** is an efficient method for producing gaseous ions. Generally, laser pulses yielding from 10^6 to 10^{10} Wcm^{-2} are focused on a sample surface of about 10^{-3} – 10^{-4} cm^2 , most often a solid.
- ❑ This technique is used in the study of surfaces and in the analysis of the local composition of samples, such as inclusions in minerals or in cell organelles. It normally allows selective ionization by adjusting the laser wavelength. However, in most conventional infrared LD modes, the laser creates a thermal spike, and thus it is not necessary to match the laser wavelength with the sample.
- ❑ Since the signals are very short, simultaneous detection analyzers or time-of-flight analyzers are required. The probability of obtaining a useful mass spectrum depends critically on the specific physical properties of the analyte (e.g. photoabsorption, volatility, etc.).
- ❑ Furthermore, the produced ions are almost always fragmentation products of the original molecule if its mass is above approximately 500 Da. This situation changed dramatically with the development of **matrix-assisted laser desorption ionization (MALDI)** ... *next slide*

2. Ion sources

2.5 Matrix-Assisted Laser Desorption Ionization (MALDI)

- ❑ Achieved in **two steps**. In the **first step**, the compound to be analyzed is mixed with a suitable **matrix** (usually small crystallized organic molecules) using a solvent. The **matrix molecules must have a strong absorption at the laser wavelength**. This **mixture is dried** before analysis, i.e. any liquid solvent used in the solution preparation is removed. The result is a 'solid solution' deposit of **analyte-doped matrix crystals**. The **analyte molecules** are embedded throughout the matrix so that they are **completely isolated** from one another.
- ❑ The **second step** occurs under vacuum conditions inside the source of the mass spectrometer - **ablation of solid solution by intense laser pulses over a short duration**. Irradiation by the laser induces rapid heating of the crystals by the accumulation of a large amount of energy in the condensed phase through excitation of the matrix molecules. The **rapid heating causes localized sublimation of the matrix crystals, ablation of a portion of the crystal surface and expansion of the matrix into the gas phase, entraining intact analyte** in the expanding matrix plume.

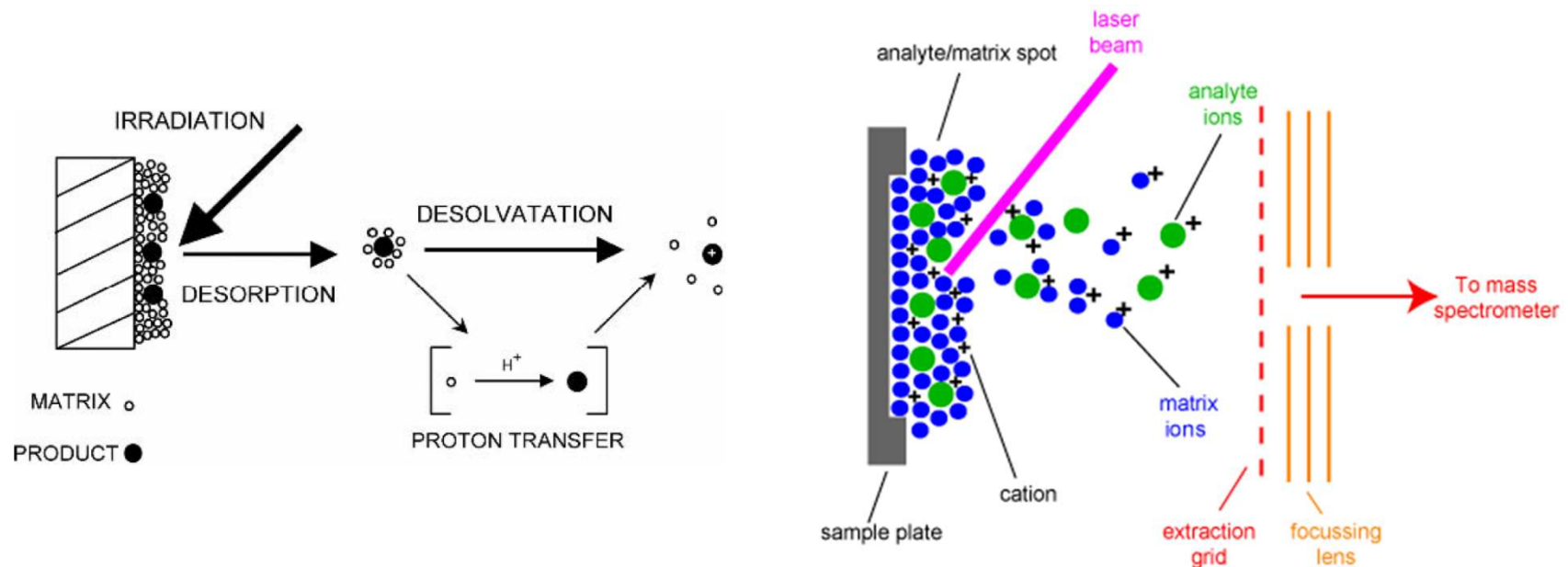

2. Ion sources

2.5 MALDI (about matrix)

... mixing some saturated matrix solution (5–10 μl) with a smaller volume (1–2 μl) of an analyte solution. Then, a droplet (0.5–2 μl) of the resulting mixture is placed on the MALDI probe, which usually consists of a metal plate with a regular array of sites for sample application. The droplet is dried at room temperature and when the liquid has completely evaporated to form crystals, the sample may be loaded into the mass spectrometer.

Analyte	Matrix	Abbreviation
Peptides/proteins	α -Cyano-4-hydroxycinnamic acid	CHCA
	2,5-Dihydroxybenzoic acid (gentisic)	DHB
	3,5-Dimethoxy-4-hydroxycinnamic acid (sinapic)	SA
Oligonucleotides	Trihydroxyacetophenone	THAP
	3-Hydroxypicolinic acid	HPA
Carbohydrates	2,5-Dihydroxybenzoic acid	DHB
	α -Cyano-4-hydroxycinnamic acid	CHCA
	Trihydroxyacetophenone	THAP
Synthetic polymers	Trans-3-indoleacrylic acid	IAA
	Dithranol	DIT
	2,5-Dihydroxybenzoic acid	DHB
Organic molecules	2,5-Dihydroxybenzoic acid	DHB
Inorganic molecules	Trans-2-(3-(4-tert-Butylphenyl)-2methyl-2-propenyliedene)malononitrile	DCTB
Lipids	Dithranol	DIT

❑ MALDI matrix selection is based on the laser wavelength used. In addition, the most effective matrix is strongly related to the class of analyte.

❑ The matrix should have strong absorbance at the laser wavelength, low enough mass to be sublimable, vacuum stability, ability to promote analyte ionization, solubility in solvents compatible with analyte and lack of chemical reactivity

2. Ion sources

2.5 MALDI (about laser)

- ❑ Generally, the **power density** required corresponds to an energy flux of **20 mJ cm⁻²**
- ❑ The laser spot diameter at the surface of the sample varies from **5 to 200 μm**.
- ❑ It is important to determine the threshold irradiance, the laser pulse power that results in the onset of matrix desorption.
- ❑ It is not necessary to adjust the wavelength to match the absorption frequency of each analyte because it is the matrix that absorbs the laser pulse.
- ❑ When an **IR laser** is used, only less fragmentation is observed, indicating that the IR-MALDI is somewhat cooler. On the other hand, IR-MALDI induces a larger depth of vaporization per shot that leads to shorter lifetime of the sample. Compared with UV-MALDI, a somewhat lower sensitivity is observed.

2. Ion sources

2.5 MALDI (processes, spectra features)

- ❑ Among the chemical and physical ionization pathways suggested for MALDI are **gas-phase photoionization**, excited state **proton transfer**, **ion–molecule reactions**, **desorption of preformed ions**, and so on.
- ❑ The most widely accepted ion formation mechanism involves **proton transfer in the solid phase** before desorption or **gas-phase proton transfer in the expanding plume from photoionized matrix molecules**.
- ❑ The matrix also minimizes **sample damage** from the laser pulse by absorbing most of the incident energy and increases the efficiency of energy transfer from the laser to the analyte. MALDI is a widespread and powerful source for the production of intact gas-phase ions from a broad range of large, non-volatile and thermally labile compounds such as proteins, oligonucleotides, synthetic polymers and large inorganic compounds.
- ❑ Because the process is independent of the absorption properties and size of the compound to be analyzed, MALDI allows the desorption and ionization of analytes with **very high molecular mass** in excess of 100000 Da. For example, MALDI allows the detection of femtomoles of proteins with molecular mass up to 300000 Da.
- ❑ Typical MALDI spectra include mainly the **monocharged molecular species by protonation in positive ion mode**. **More easily deprotonated compounds are usually detected in negative ion mode**.
- ❑ Compounds that are not easily protonated can be cationized instead, often by adding a small quantity of alkali, copper or silver cations to the sample.

2. Ion sources

2.5 MALDI (fragmentation)

Fragmentations

There are essentially three different types of fragmentations that generate fragment ions in MALDI spectra.

- 1) Fragmentations taking place in the source are called **in-source decay (ISD)** fragmentations. To be precise, fragmentation at the sample surface that occurs before or during the desorption event (on a time scale of a few picoseconds to nanoseconds) is called **prompt fragmentation**.
- 2) Fragmentation occurring in the source after the desorption event but before the acceleration event (on a time scale of a few nanoseconds to microseconds) is called **fast fragmentation**.
- 3) Fragmentation that occurs after the acceleration region of the mass spectrometer is called **post-source decay (PSD)** fragmentation. It corresponds to the fragmentation of metastable ions, which are stable enough to leave the source but contain enough excess energy to allow their fragmentation before they reach the detector.

Acquisition of an excess of internal energy can be due to the direct interaction photon/molecule, to ionization energy and to activation of molecules in solid state. Another important mechanism consists of the multiple collisions that ions undergo in the source. These collisions can be controlled by the strength of the electric field used to extract the ions from the source.

ISD fragmentations lead to product ions that are always apparent in the MALDI spectra, whereas the observation of product ions from PSD fragmentation needs certain instrumental conditions. This induces a broadening of the peaks with a concomitant loss of mass resolution and sensitivity.

2. Ion sources

2.5 MALDI (pros and cons)

- ❑ MALDI is more sensitive than other laser ionization techniques. Indeed, the number of matrix molecules exceeds widely those of the analyte, thus separating the analyte molecules and thereby preventing the formation of *sample clusters* that inhibit the appearance of molecular ions.
- ❑ MALDI suffers from some disadvantages such as low **shot-to-shot reproducibility** and strong dependence on the sample preparation method.
- ❑ High concentrations of buffers and other contaminants commonly found in analyte solutions can interfere with the desorption and ionization process of samples.
- ❑ Prior purification to remove the contaminants leads to improvements in the quality of mass spectra. For instance, the removal of alkali ions has proven to be very important for achieving high desorption efficiency and mass resolution.

Other variations

- ❑ (Matrix-free) **surface-activated laser desorption ionization (SALDI)** uses graphite as the surface.
- ❑ But the use of porous silicon as a new surface is more promising and has led to the development of a new method called **desorption ionization on silicon (DIOS)**.
 - The structure of porous silicon allows the analyte molecules to be retained while its strong UV absorption allows the desorption ionization of the sample under UV laser irradiation.
 - DIOS mass spectra do not present interference in the low-mass range, while signals due to the matrix are observed in MALDI. It allows small molecules (100–3000 Da) to be easily analysed. Furthermore, DIOS is equivalent to MALDI in sensitivity, but is more tolerant of the presence of salts or buffers.

2. Ion sources

2.5 MALDI (at atmosph. pressure)

Atmospheric Pressure MALDI

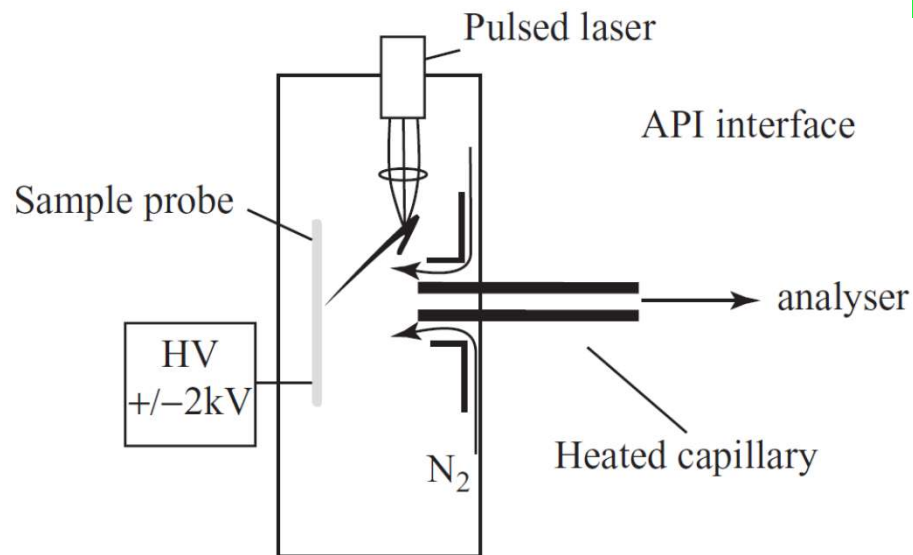

As the transfer of ions into the mass spectrometer is **relatively inefficient**, the total sample consumption is higher for AP-MALDI than for vacuum MALDI.

Because of the fast and **efficient thermalization** of the ion internal energy at atmospheric conditions, AP MALDI is a softer ionization technique compared with conventional vacuum MALDI and even softer than vacuum IR-MALDI. Ions produced by this method generally exhibit **no fragmentation** but tend to form clusters with the matrix. These unwanted adducts between matrix and analyte can be eliminated by increasing the energy transferred to the ions in the source. For instance, increasing the laser energy or some API parameters, such as capillary temperature, increases the analyte-matrix dissociation process.

*As a result of the almost **complete decoupling** of the ion desorption from the **mass analyser**, the performance of the instrument (**calibration, resolution and mass accuracy**) is not affected by source conditions (**type of sample matrix, sample preparation method and location of the laser spot on the sample**). This allows much greater experimental flexibility. It is possible, for instance, to use long-pulse lasers to increase the overall sensitivity without observing deterioration in resolution.*

2. Ion sources

2.6 Electrospray (ESI)

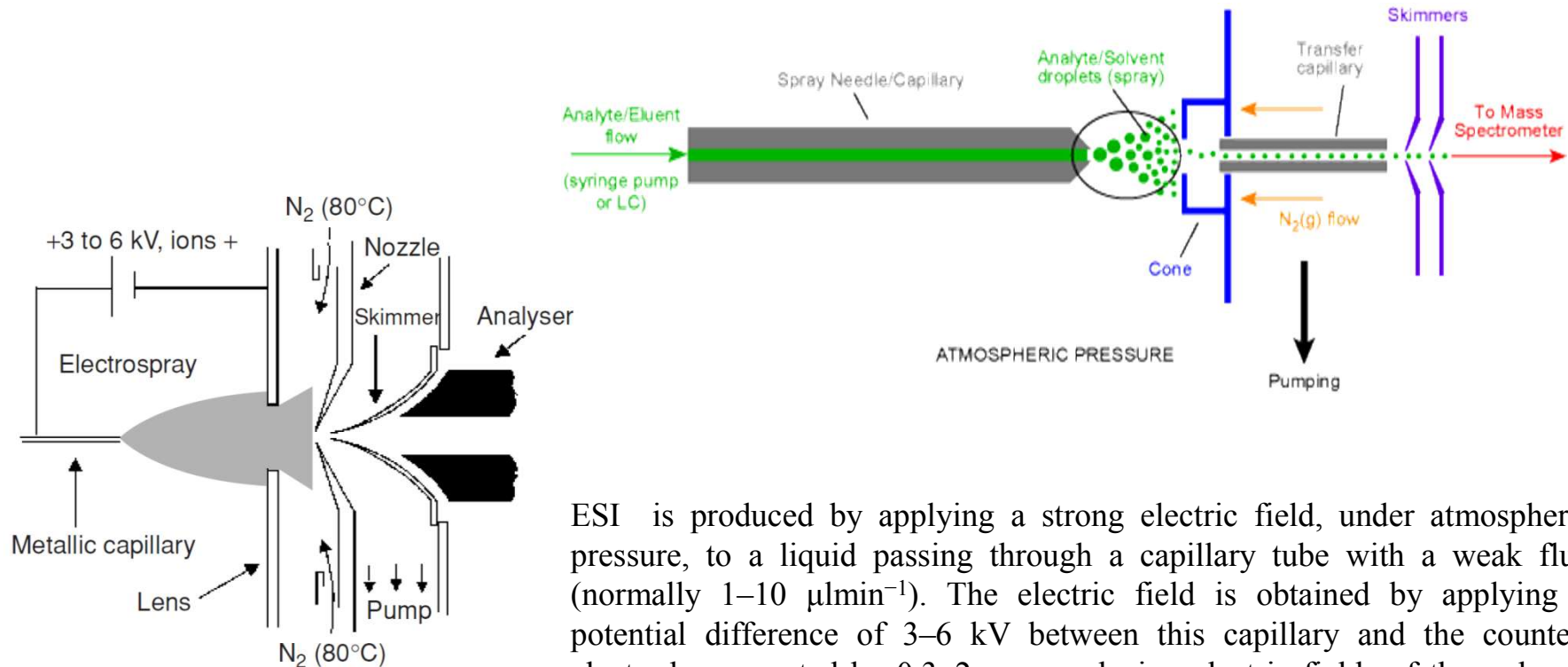

ESI is produced by applying a strong electric field, under atmospheric pressure, to a liquid passing through a capillary tube with a weak flux (normally 1–10 μLmin^{-1}). The electric field is obtained by applying a potential difference of 3–6 kV between this capillary and the counter-electrode, separated by 0.3–2 cm, producing electric fields of the order of 10^6Vm^{-1}

A gas injected coaxially at a low flow rate allows the dispersion of the spray to be limited in space.

These droplets then pass either through a curtain of **heated inert gas**, most often **nitrogen**, or through a **heated capillary** to remove the last solvent molecules.

The spray starts at an '**onset voltage**' that, for a given source, depends on the surface tension of the solvent. In a source which has an onset voltage of 4 kV for **water** (surface tension 0.073Nm^{-2}), 2.2 kV is estimated for **methanol** (0.023Nm^{-2}), 2.5 kV for **acetonitrile** (0.030Nm^{-2}) and 3 kV for **dimethylsulfoxide** (0.043Nm^{-2}).

2. Ion sources

2.6 Electrospray (ESI) (contin.)

If one examines with a microscope the nascent drop forming at the tip of the capillary while increasing the voltage, at low voltages the drop appears spherical, then elongates under the pressure of the accumulated charges at the tip in the stronger electric field; when the surface tension is broken, the shape of the drop changes to a 'Taylor cone' and the spray appears.

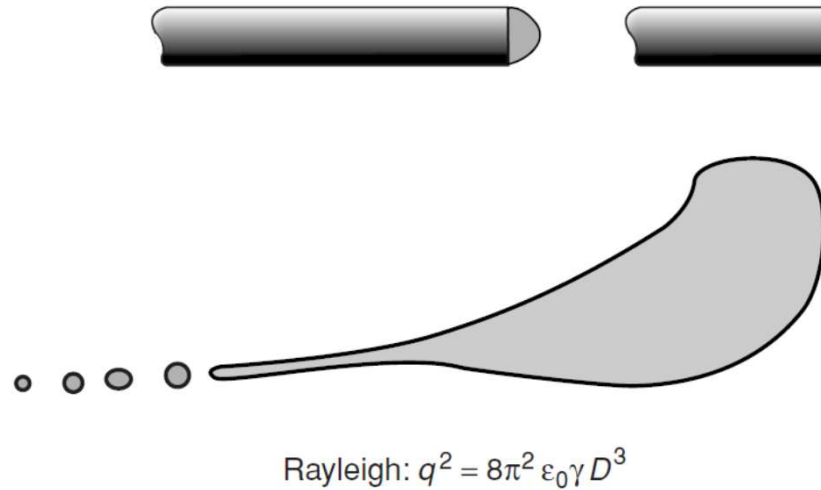

A decomposing droplet in an electrospray source; q , charge; ϵ_0 , permittivity of the environment; γ , surface tension and D , diameter of a supposed spherical droplet.

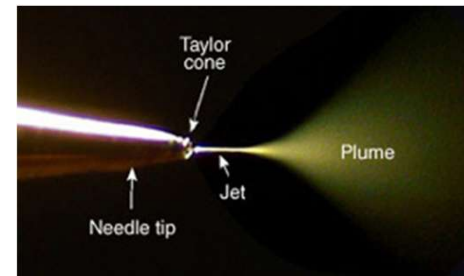

*Breakdown of the droplets can occur before the limit given by the **Rayleigh equation** is reached because the droplets are mechanically deformed, thus reducing the repulsion necessary to break down the droplets. The solvent contained in the droplets evaporates, which causes them to shrink and their charge per unit volume to increase.*

2. Ion sources

2.6 Electrospray (ESI) (contin.)

- ❑ From this **Taylor cone**, about 20 smaller droplets are released. Typically a first-generation droplet from the capillary will have a diameter of about 1.5 μm and will carry around 50 000 elementary charges, or about 10^{-14} C. The offspring droplets will have a diameter of 0.1 μm and will carry 300 to 400 elementary charges. The total volume of the offspring droplets is about 2% of the precursor droplet but contain 15% of the charge. The charge per unit volume is thus multiplied by a factor of seven. The **precursor droplet** will shrink further by **solvent evaporation** and will produce other generations of offspring.
- ❑ These small, highly charged droplets will continue to lose solvent, and when the electric field on their surface becomes large enough, desorption of ions from the surface occurs. Sensitivity is higher for compounds whose concentration at the surface is higher, thus more lipophilic ones.
- ❑ When the droplet contains very **large molecules**, like **proteins** for example, the molecules will not *desorb*, but are *freed by evaporation* of the solvent. This seems to occur when the molecular weight of the compounds exceeds **5000 to 10 000 Da**.
- ❑ The ions obtained from **large molecules** carry a greater number of charges if several ionizable sites are present. Typically, a protein will carry one charge per thousand daltons approximately, less if there are very few basic amino acids. **Small molecules**, say less than a thousand daltons, will produce mainly **monocharged** ions.
- ❑ ESI can also be used in the case of molecules without any ionizable site through the formation of sodium, potassium, ammonium, chloride, acetate or other adducts.

*ESI has important characteristics: for instance, it is able to produce **multiply charged ions** from **large molecules**. The formation of ions is a result of the electrochemical process and of the accumulation of charge in the droplets.*

2. Ion sources

2.6 Electrospray (ESI) (contin.)

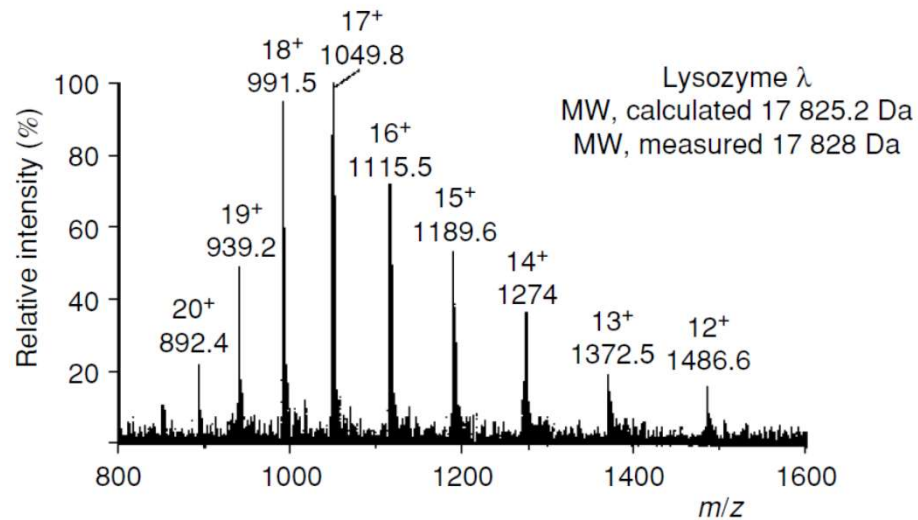

ESI spectrum of phage lambda lysozyme. The molecular mass is measured as being $17\,828 \pm 2.0$ Da.

An ion separated from the first one by $(j-1)$ peaks, in increasing order of mass-to-charge ratio, has a measured ratio of m_2 Th and a number of charges $z_1 - j$, so that

$$z_1 = \frac{j(m_2 - m_p)}{(m_2 - m_1)} \quad \text{and} \quad M = z_1(m_1 - m_p) \quad z_1 = \frac{j(m_2 + m_p)}{(m_2 - m_1)} \quad \text{and} \quad M = z_1(m_1 + m_p)$$

The ESI mass spectra of biological macromolecules normally correspond to a statistical distribution of consecutive peaks characteristic of multiply charged molecular ions obtained through **protonation** $(M+zH)^{z+}$, or **deprotonation** $(M-zH)^{z-}$, with minor if any contributions of ions produced by *dissociations or fragmentations*.

Consider a positive ion with charge z_1 whose mass-to-charge ratio is measured as being m_1 Th, issued from a **molecular ion** with mass M Da to which z_1 protons have been added. We then have

$$z_1 m_1 = M + z_1 m_p$$

where m_p is the mass of the proton

2. Ion sources

2.6 Electrospray (ESI) (contin.)

Using the peaks at m/z 939.2 and 1372.5 ($j = 6$), we obtain $z_1 = 6(1372.5 - 1.0073)/(1372.5 - 939.2) = 19$ and we can number all the peaks measured according to the number of charges. M can be calculated from their mass. This technique allowed the determination of the molecular masses of proteins above 130 kDa with a detection limit of about 1 pmol using a quadrupole analyser

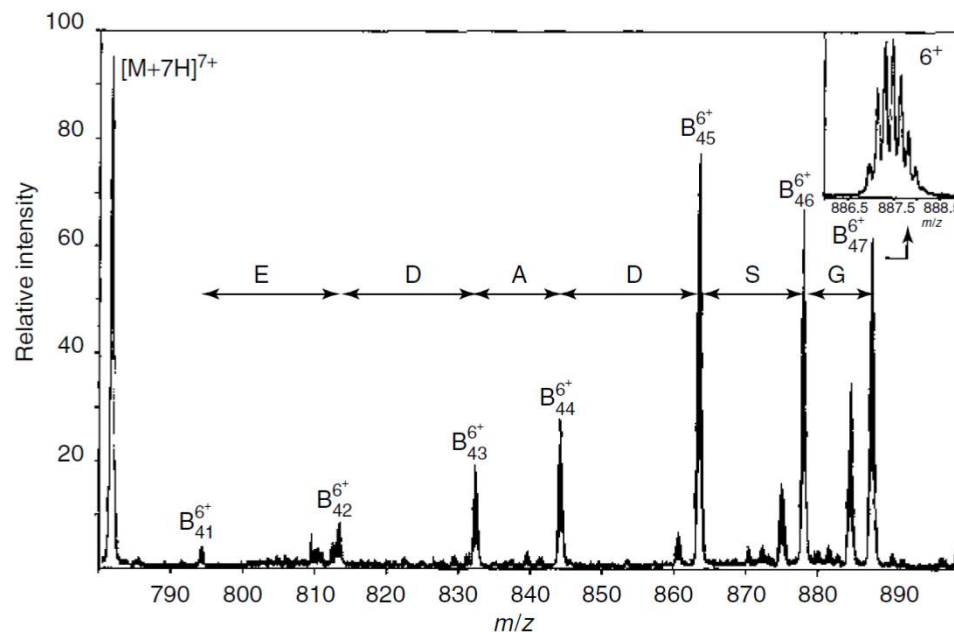

Product ion spectrum of the $[M + 7H]^{7+}$ ion from the following peptide:
ALVRQGLAKVAYVYKPNNTHEQHRLRKSEA
QAKKEKLLNIWSEDNADSGQ.

Notice that fragment ions having lower charge number z may appear at higher m/z values than the precursor, which indeed occurs in the spectrum shown. The inset shows that, owing to the high resolution, the isotopic peaks are observed separated by $1/6$ Th, and thus $1/z = 1/6$ or $z = 6$. As neighbour peaks differ by 1Da, the observed distance between them will be $1/z$, allowing the direct determination of the charge state of the corresponding ion.

2. Ion sources

2.6 Electrospray (ESI) (contin.)

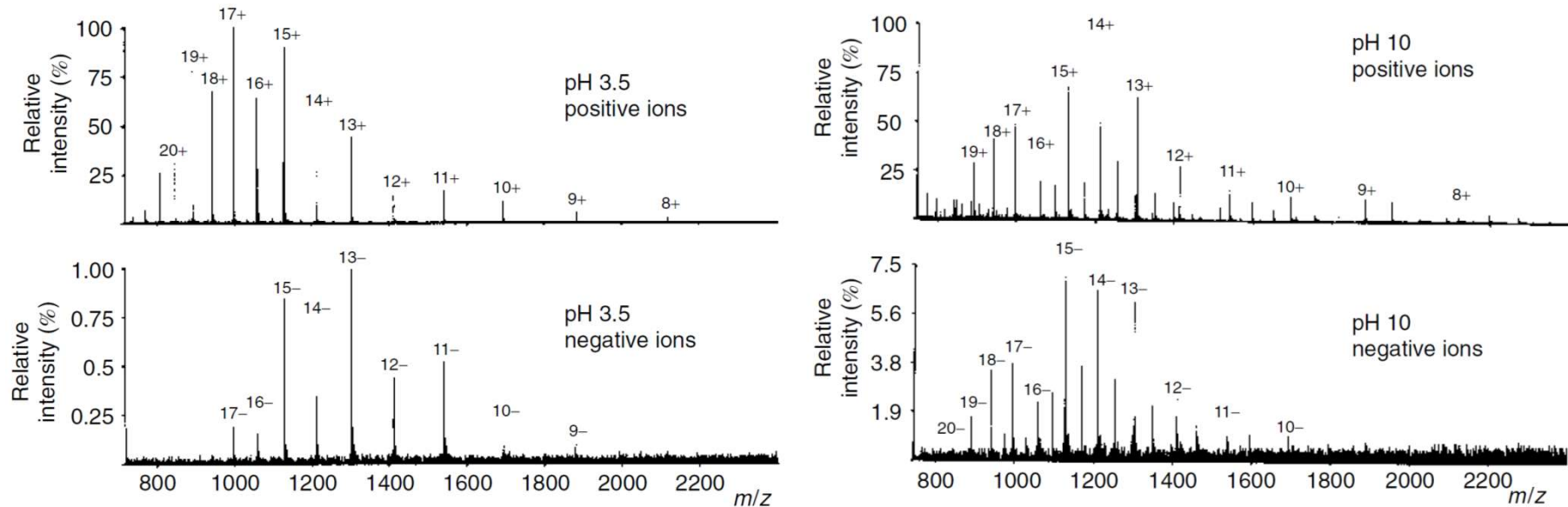

*Charges of ions generated by ESI do not reflect the charge state of compounds in the analysed solution, but are the result of both **charge accumulation** in the droplets and **charge modification** by electrochemical process at the probe tip.*

The negative ion spectrum of myoglobin at pH 3 shows a better signal-to-noise ratio than the same spectrum at pH 10.

pH is a measure of the **acidity** or **basicity** of an aqueous solution. Solutions with a pH less than 7 are said to be acidic and solutions with a pH greater than 7 are basic or alkaline. Pure water has a pH very close to 7.

2. Ion sources

2.6 Electrospray (ESI)

Sensitivity to Concentration

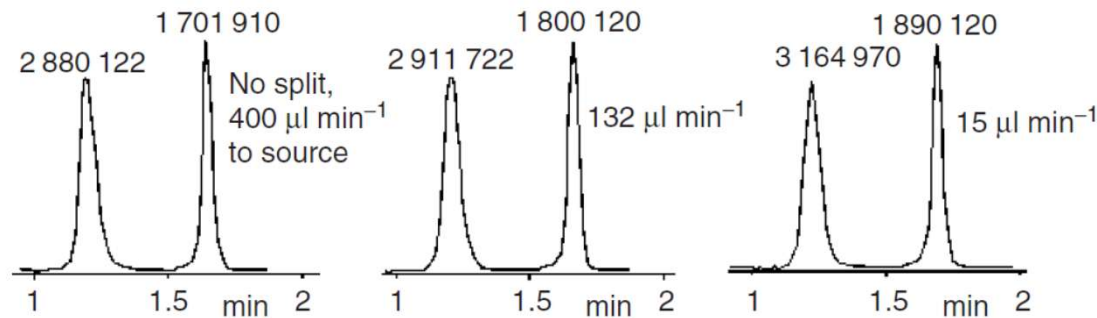

Another feature of ESI is its sensitivity to concentration, and not to the total quantity of sample injected in the source, as is the case for most other sources.

The sensitivity increases somewhat when the flow entering the source is reduced. This remains true up to flows as low as some tens of nanolitres per minute. When flow rates higher than about $500 \mu\text{l min}^{-1}$ are used, the sensitivity is reduced. Lower flow rates also allow less analyte and buffer to be injected in the source, **reducing contamination**. Furthermore, for the same amount of sample, an HPLC column with a lower diameter, and using smaller flow rates, will give an increased sensitivity because the concentration of the sample in the elution solvent is increased. *Based on this concentration dependence, modifications of the technique, called **microelectrospray** (μESI), or **nanospray** (nESI), which use much lower flow rates down to some tens of **nanolitres per minute**, have been developed using adapted probe tips. Detection limits in the range of **attomoles** (10^{-15} moles) injected have been demonstrated.*

2. Ion sources

2.6 Electrospray (ESI) (contin.)

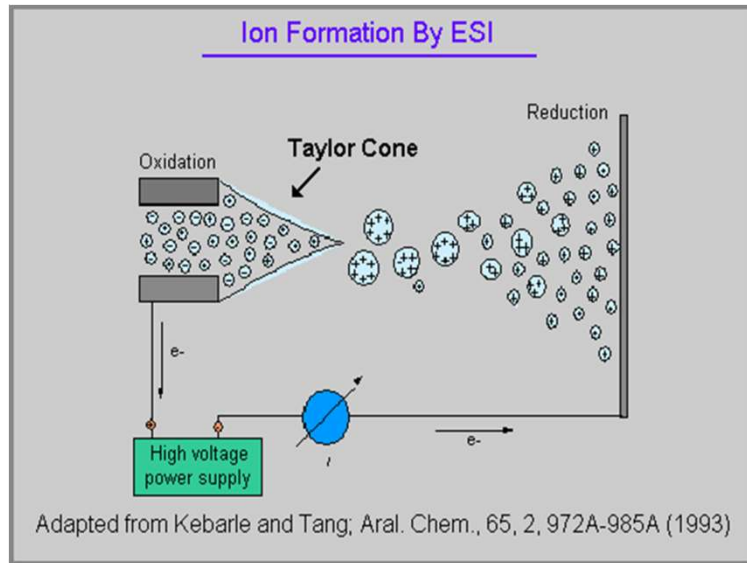

When positive ions are extracted for analysis, electrons have to be provided in the circuit from the capillary. The same number of negative charges must be 'pumped' out of the solution as positive charges are extracted to the analyser, thus an **oxidation** occurs. For negative ions, electrons have to be consumed, and thus a **reduction** occurs.

A major consequence is that the total number of ions per unit time that can be extracted to the spectrometer is actually limited by the electric current produced by the oxidation or reduction process at the probe tip.

*This limiting current is not dependent on the flow rate, up to very low flow, and this explains why ESI is only **concentration dependent**. In practice, the total ion current is limited to a maximum of about $1 \mu\text{A}$.*

Ions, either positive or negative, of an **analyte A** will be desorbed from the droplets, producing a theoretical ion current $I_A = k_A[A]$, where k_A is a rate constant depending on the nature of A . Let us suppose that another ion **B** is produced from the **buffer**, at a rate $I_B = k_B[B]$.

The total ion current for these two ions $I_T = (I_A + I_B)$, but this total ion current is limited by the **oxidation**, if positive ions are desorbed, or **reduction** process that occurs at the probe tip.

2. Ion sources

2.6 Electrospray (ESI) (contin.)

- ❑ The ESI source is a **constant-current electrochemical cell**. The important consequence is that there will be a constant current I_M carried by the ions.
- ❑ If there are too many ions from salts in the flow, they will suffice to produce I_M and the ions of the sample will be either at low abundances or not observed.
- ❑ On the other hand, if the solution is very dilute and at very low flow (below 1 μl), the ion flow from the capillary can be insufficient to provide I_M .
- ❑ The electrochemical process at the probe tip will then produce additional ions by **oxidation** (or **reduction** in negative ion mode) of either the *solvent or the sample* depending on their respective oxidation (reduction) potentials.

*This will lead to the observation of **radical cations** or **radical anions** in the spectrum.*

2. Ion sources

2.6 Electrospray (ESI) (contin.)

This limiting current is symbolized I_M , and $I_T = I_M$ if no other ionic species are present. The current for each ion will be proportional to its **relative desorption rate**

$$I_A = I_M \frac{k_A [A]}{k_A [A] + k_B [B]} \quad I_B = I_M \frac{k_B [B]}{k_A [A] + k_B [B]}$$

Let us consider that $[B]$ remains constant, but the analyte concentration $[A]$ varies; then two limiting cases are to be considered. First, for $k_A [A] \ll k_B [B]$,

$$I_A \approx I_M \frac{k_A [A]}{k_B [B]} \quad I_B \approx I_M \frac{k_B [B]}{k_B [B]} \approx I_M$$

This means that the intensity detected for A will be proportional to its concentration, but the sensitivity will be inversely proportional to $[B]$.

The other extreme case leads to

$$I_A \approx I_M \frac{k_A [A]}{k_A [A]} \approx I_M \quad I_B \approx I_M \frac{k_B [B]}{k_A [A]}$$

I_A remains constant, and quantitation of $[A]$ is no longer possible. The intensity of the signal for B will become weaker as $[A]$ increases.

2. Ion sources

2.6 Electrospray (ESI) (contin.)

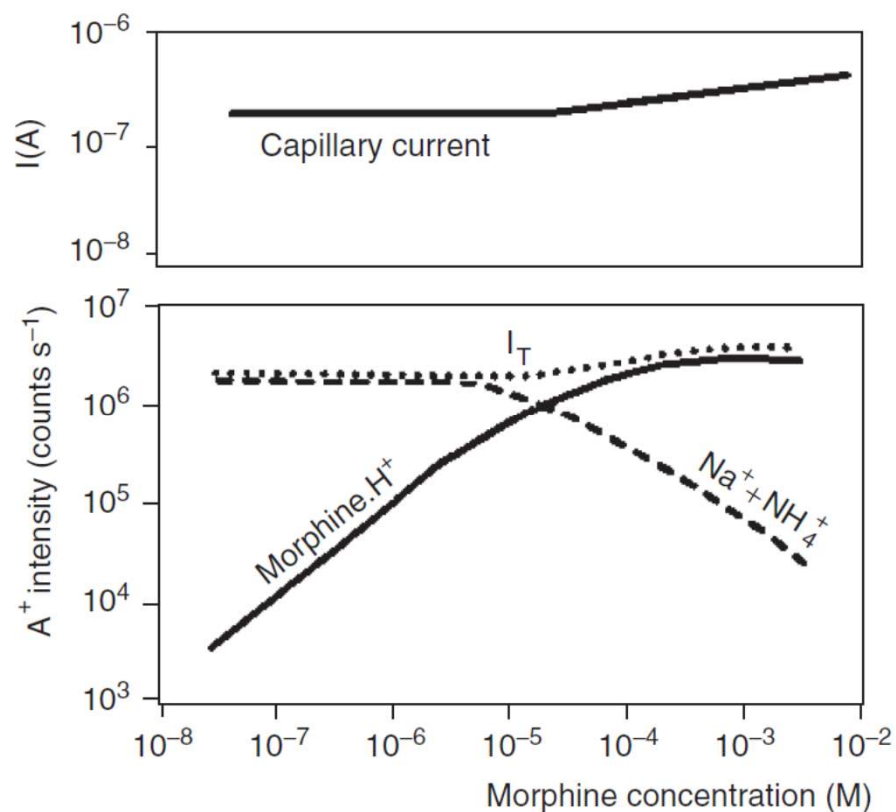

In a solvent containing NH_4^+ and Na^+ ions at constant concentrations, an increasing amount of **morphine chlorhydrate** is added. The graph shows on top the number of amperes at the capillary tip, and below the intensity monitored at the mass of protonated morphine and the sum of the intensities for the NH_4^+ and Na^+ ions. Linearity is observed at low concentrations, but from about 5×10^{-6} significant curvature is observed (note that the scales are logarithmic) the intensity for morphine is constant, and the signal for the other ions diminishes. At still higher concentrations, the intensity levels out.

3. Mass Analyzers

Type of analyser	Symbol	Principle of separation
Electric sector	E or ESA	Kinetic energy
Magnetic sector	B	Momentum
Quadrupole	Q	m/z (trajectory stability)
Ion trap	IT	m/z (resonance frequency)
Time-of-flight	TOF	Velocity (flight time)
Fourier transform ion cyclotron resonance	FTICR	m/z (resonance frequency)
Fourier transform orbitrap	FT-OT	m/z (resonance frequency)

Measuring the performance of a mass analyzer

Mass resolution or resolving power

Mass range limit - The mass range determines the limit of m/z over which the mass analyzer can measure ions. It is expressed in Th, or in u for an ion carrying an elementary charge, that is $z = 1$.

Analysis speed - The analysis speed, also called the scan speed, is the rate at which the analyzer measures over a particular mass range. It is expressed in mass units per second ($u\ s^{-1}$) or in mass units per millisecond ($u\ ms^{-1}$).

Transmission - The transmission is the ratio of the number of ions reaching the detector and the number of ions entering the mass analyzer. Sensitivity of spectrometer is related to transmission.

Mass accuracy - Mass accuracy indicates the accuracy of the m/z provided by the mass analyzer. It is the difference that is observed between the theoretical m/z ($m_{\text{theoretical}}$) and the measured m/z (m_{measured}). It can be expressed in millimass units (mmu) but is often expressed in parts per million (ppm).

Resolution or resolving power

resolving power $R = M / \Delta M$
where ΔM is the resolution

- A measure of ability to separate and identify ions of slightly different masses. Usually defined in terms of the largest mass at which a given criterion is met.
- The most popular “valley” definition: highest mass at which two adjacent peaks of equal height, differing in mass by ΔM , exhibit a valley between the peaks not greater than a certain percentage such as 2 or 10 %, of the peak height.
- In practice, resolution must often be determined using an isolated peak. Then ΔM is often taken as the width of the peak at 50 % peak height level (FWHM).

For example resolving power of 2500 is required to separate the N_2^+ peak (mass = 28.006148) from CO^+ peak (mass = 27.994915), even though the nominal mass is only 28.

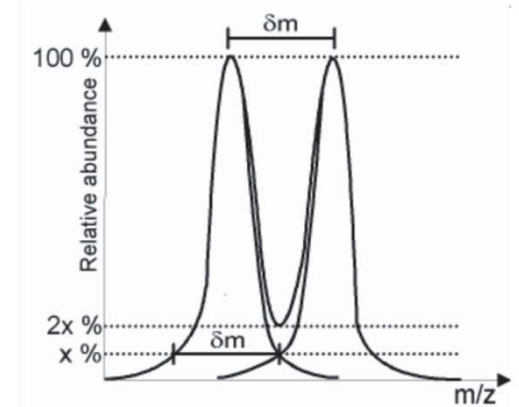
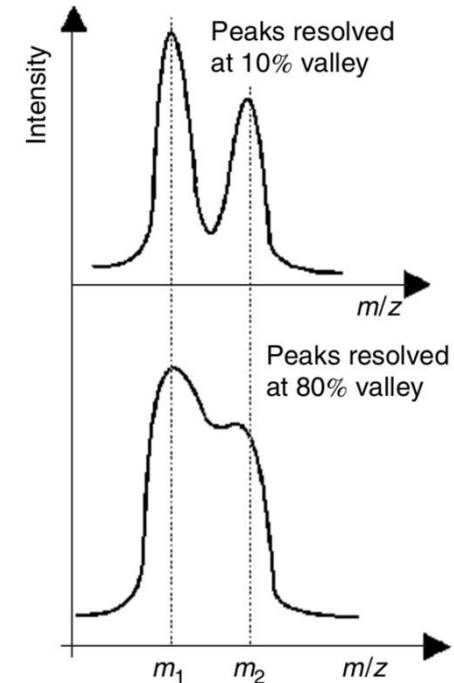

Sensitivity

Sensitivity and resolving power are inversely proportional!

- ❑ A measure of the instrument's response to ions of a particular component at an arbitrary m/z value. It is expressed for a particular peak and a particular sample
- ❑ various materials exhibit different efficiencies for ionization in the source,
- ❑ there might be differences in the efficiencies of the transmission of ions through the mass analyzer
- ❑ the detector may exhibit a higher or lower efficiency for a particular mass or type of ion.

instrument noise level, i.e. the spurious instrument response not due to ions striking the ion collector – signal-to-noise at least 2:1 for good measurement
instrument background, instrument response, at a given mass, without the sample

3. Mass Analysers

3.1 Quadrupole Analyzers

The quadrupole analyzer is a device which uses the stability of the trajectories in oscillating electric fields to separate ions according to their m/z ratios. The 2D or 3D ion traps are based on the same principle.

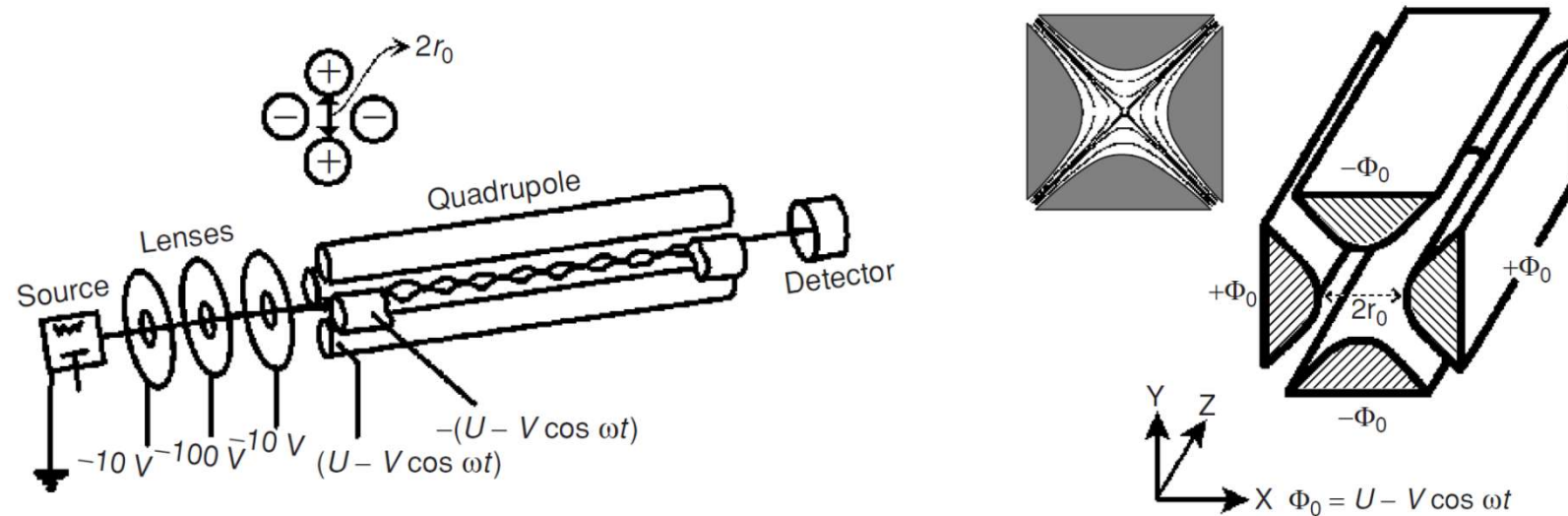

$\Phi_0 \sim$ potential applied to the rods.

$\omega \sim$ the angular frequency (in radians per second $= 2\pi\nu$, where ν is the frequency of the RF field).

$U \sim$ the direct potential (500 to 2000V).

$V \sim$ the 'zero-to-peak' amplitude of the RF voltage, 0 to 3000V (from -3000 to $+3000V$ peak to peak).

3. Mass Analyzers

3.1 Quadrupole Analyzers (contin.)

Equations of Motion

$$F_x = m \frac{d^2x}{dt^2} = -ze \frac{\partial \Phi}{\partial x}$$

$$F_y = m \frac{d^2y}{dt^2} = -ze \frac{\partial \Phi}{\partial y}$$

$$\Phi_{(x,y)} = \Phi_0(x^2 - y^2)/r_0^2 = (x^2 - y^2)(U - V \cos \omega t)/r_0^2$$

Differentiating and rearranging the terms leads to the following equations of the movement (**Paul equation**):

$$\frac{d^2x}{dt^2} + \frac{2ze}{mr_0^2} (U - V \cos \omega t) x = 0$$

$$\frac{d^2y}{dt^2} - \frac{2ze}{mr_0^2} (U - V \cos \omega t) y = 0$$

3. Mass Analyzers

3.1 Quadrupole Analyzers (contin.)

The trajectory of an ion will be stable if the values of x and y never reach r_0 , thus if it never hits the rods. The following equation was established in 1866 by the physicist **Mathieu** in order to describe the propagation of waves in membranes:

$$\frac{d^2u}{d\xi^2} + (a_u - 2q_u \cos 2\xi) u = 0$$

u stands for either x or y . Comparing the preceding equations with this one, and taking into account that the **potential along y has opposite sign to the one along x** , the following change of variables gives to the equations of the movement the form of the **Mathieu equation**. First, ξ is defined as being

$$\xi = \frac{\omega t}{2} \quad \text{and} \quad \text{thus} \quad \xi^2 = \frac{\omega^2 t^2}{4}$$

In the first term of the **Paul equation**, replacing t^2 by ξ^2 introduces a factor $\omega^2/4$. To compensate for this factor, the whole equation must be multiplied by the reverse, $4/\omega^2$. In the cosine term, 2ξ is equal to ωt , as needed in the Paul equations. Incorporating these changes and rearranging the terms yields the following expressions:

$$a_u = a_x = -a_y = \frac{8zeU}{m\omega^2 r_0^2} \quad \text{and} \quad q_u = q_x = -q_y = \frac{4zeV}{m\omega^2 r_0^2}$$

As long as x and y , which determine the position of an ion from the centre of the rods, both remain less than r_0 , the ion will be able to pass the quadrupole without touching the rods.

3. Mass Analyzers

3.1 Quadrupole Analyzers (contin.)

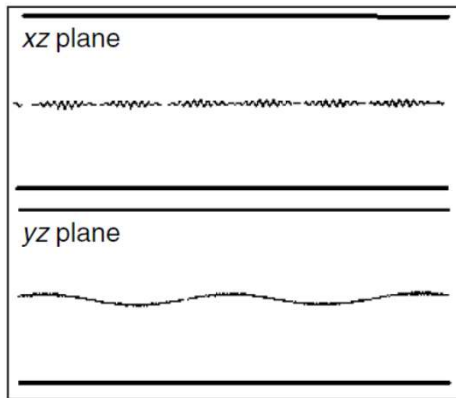

Stable along both x and y

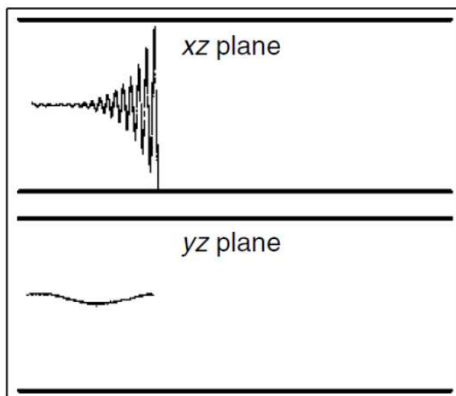

Stable along y, unstable along x

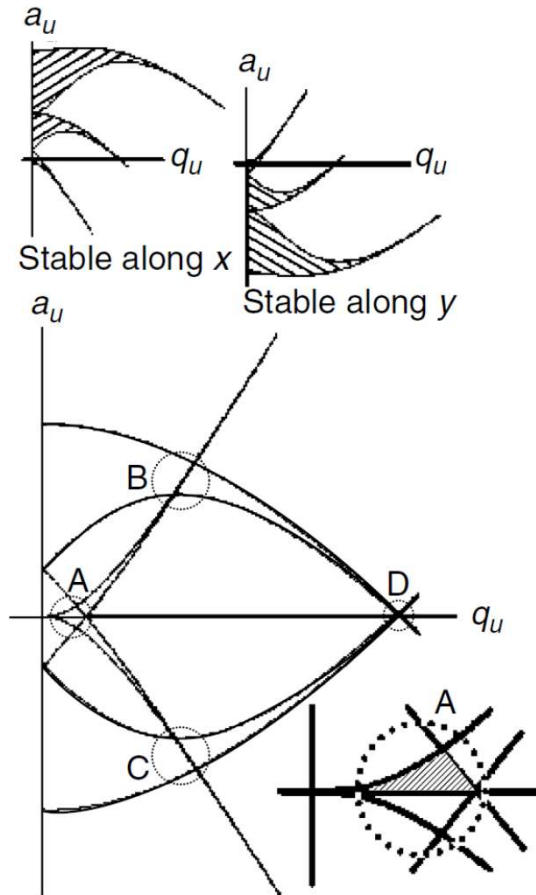

Stability areas for an ion along x or y and along x and y; u represents either x or y. The four stability areas are labelled A to D and are circled.

The area A is that used commonly in mass spectrometers.

In practice, the highest detectable m/z ratio is about **4000 Th**, and the resolution hovers around **3000**. Thus, beyond **3000 u** the isotope clusters are no longer clearly resolved.

Usually, quadrupole mass spectrometers are operated at unit resolution, that is a resolution that is sufficient to separate two peaks one mass unit apart.

Quadrupoles are low-resolution instruments.

3. Mass Analyzers

3.1 Quadrupole Analyzers (contin.)

$$U = a_u \frac{m \omega^2 r_0^2}{z 8e} \quad \text{and} \quad V = q_u \frac{m \omega^2 r_0^2}{z 4e}$$

The last terms of both the U and V equations is a constant for a given quadrupole instrument, as they operate at constant ω . We see that switching from one m/z to another results in a proportional multiplication of a_u and q_u , which means changing the scale of the drawing in U, V coordinates; thus the triangular area A will change from one mass to another, like proportional triangles.

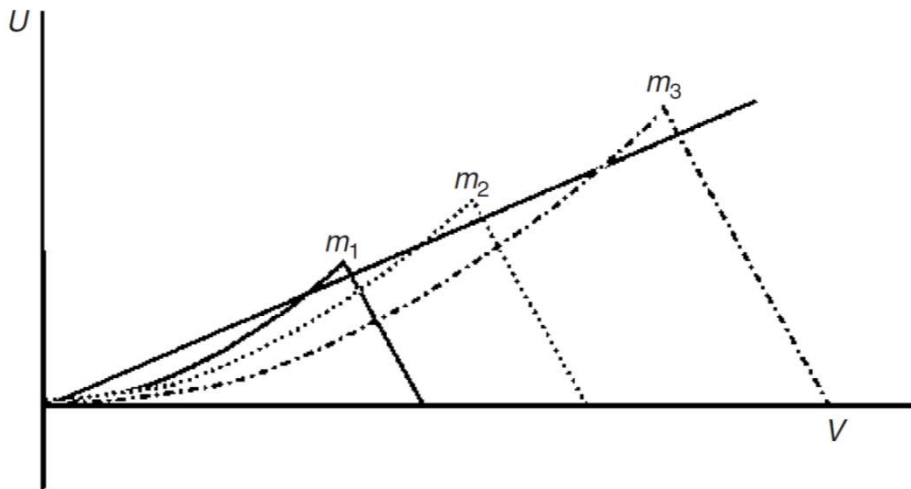

Stability areas as a function of U and V for ions with different masses ($m_1 < m_2 < m_3$). Changing U linearly as a function of V , we obtain a straight operating line that allows us to observe those ions successively.

A line with a **higher slope** would give us a **higher resolution**, so long as it goes through the stability areas.

Keeping $U = 0$ (no direct potential) we obtain zero resolution. All of the ions have a stable trajectory so long as V is within the limits of their stability area.

3. Mass Analyzers

3.1 Quadrupole Analyzers (contin.)

These quadrupoles also have the property of focusing the trajectory of the ions towards the centre of the quadrupole.

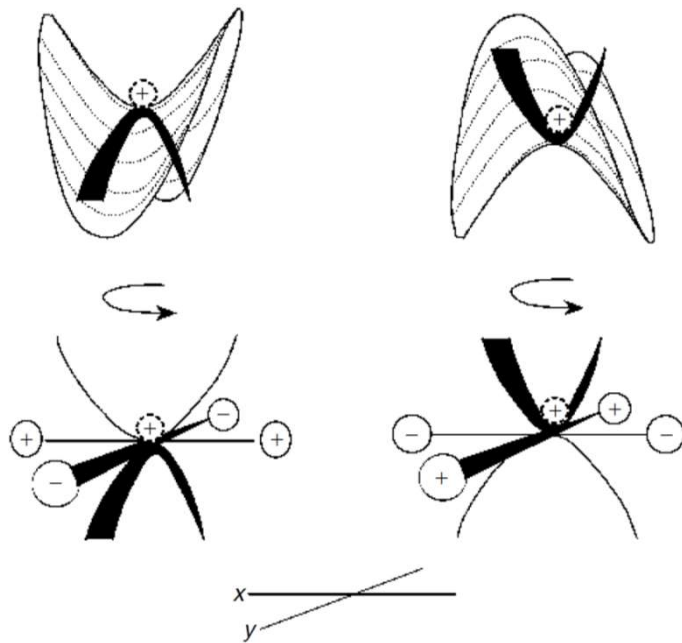

It goes down the potential 'valley' with respect to the negative rods, and acquires some kinetic energy in that direction. However, the potentials quickly change, so that the **kinetic energy** is converted into **potential energy** and the ion goes back to the centre of the rods, as would happen for a ball on a horse's saddle that is turned quickly. The name '**saddle field**' is an allusion to this phenomenon.

The time for crossing the analyzer is short compared with the time necessary to switch from one mass to the other,

The ions remain long enough between the rods for a few oscillations of the alternative potential to occur. This means that the kinetic energy at the source exit must range from 1-100 eV.

3. Mass Analyzers

3.1 Quadrupole Analyzers (contin.)

Ion Guide and Collision Cell

When U is equal to zero (quadrupole operating in the RF only mode) all of the ions with a mass higher than a given limit selected by adjusting the value of the RF voltage V have a stable trajectory.

But the transmission of ions with high masses suffers from their poorer focusing. Indeed, the efficiency of focusing depends on the depth of the effective potential well, which is inversely proportional to m/z . Consequently, ions with high m/z are weakly focused and may be lost on the rods.

To increase the transmission of ions with high masses by a more efficient focalization, the RF voltage V is increased. Indeed, the depth of the effective potential well, which influences the efficiency of focusing, is proportional to V^2 . **However, all heavy ions are poorly focused when V is low and all light ions are lost when V is high.**



The quadrupoles operating in RF-only mode have the property to focus the trajectory of ions. The use of quadrupoles as ion guides or ion focusing devices has been extended to other **multipoles** as **hexapoles** and **octapoles**. An RF voltage V is applied to the rods, with a polarity inverted from one rod to the next one.

$$U(r) = n^2 z^2 e^2 V^2 / (4mr_0^2 \omega^2) (r/r_0)^{2n-2}$$

As an ion moves from the centre of the multipole towards any one of the rods, the potential increases to reach a maximum at the surface of the rod. For the quadrupole ($n = 2$), the potential varies as $(r/r_0)^2$, whereas the hexapole ($n = 3$) and the octapole ($n = 4$) have potentials that vary as $(r/r_0)^4$ and $(r/r_0)^6$, respectively.

3. Mass Analyzers

3.1 Quadrupole Analyzers (contin.)

Type	Focusing power	Mass range for simultaneous transmission of ions
Quadrupole	High	Narrow
Hexapole		
Octapole	Low	Wide

- ❑ While the **octapole** has a *softer potential* around the centre but a *steeper potential* close to the rods. Furthermore, for the same conditions, the maximum potential generated by an octapole has an amplitude that is four times higher than the potential generated by a quadrupole.
- ❑ The extent of the mass range for simultaneous transmission of ions is not important when the ion guide is combined with a scanning analyzer.
- ❑ TOF measure all the ions simultaneously, requires ion guides that transmit all the ions together at the same time in the entire mass range of the analyzer.

3. Mass Analyzers

3.2 Quadrupole ion traps (QITs).

An ion trap is a device that uses an oscillating electric field to store ions. The ion trap works by using an RF quadrupolar field that traps ions in two or three dimensions.

3D ion trap - Paul ion trap

2D ion trap - Four rod quadrupole ending in lenses that reflect ions forwards and backwards in that quadrupole.

Conceptually, a Paul ion trap can be imagined as a quadrupole bent in on itself in order to form a closed loop. The inner rod is reduced to a point at the centre of the trap, the outer rod is the circular electrode, and the top and bottom rods make up the caps.

In quadrupole instruments, the potentials are adjusted so that only ions with a selected mass go through the rods.

The principle is different in this case. Ions of different masses are present together inside the trap, and are expelled (by applying a resonant frequency along z) according to their masses so as to obtain the spectrum.

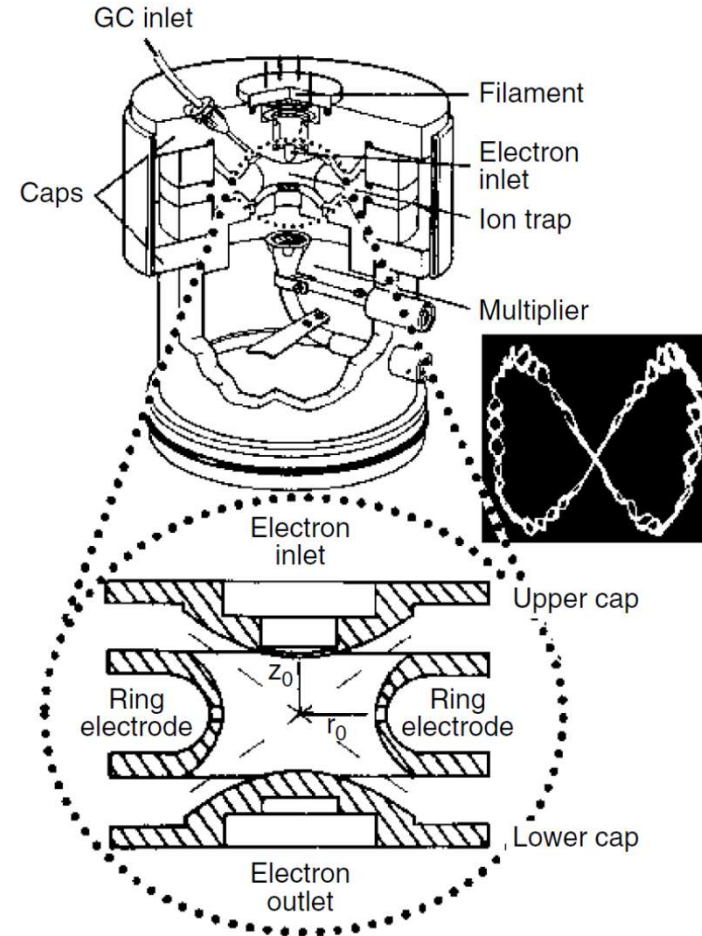

3. Mass Analyzers

3.2 Quadrupole ion traps (contin.).

To avoid **ion losses** by expansion, a pressure of helium gas which removes excess energy from the ions by collision. This pressure hovers around 10^{-3} Torr (0.13 Pa). A single high-vacuum pump with a flow of about 40 l s^{-1} is sufficient to maintain such a vacuum compared with the 250 l s^{-1} needed for other mass spectrometers.

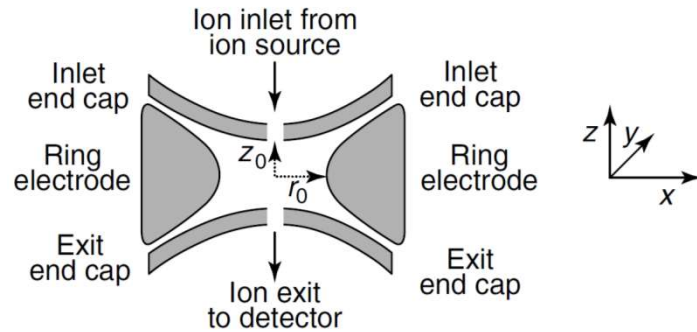

In the Paul ion trap the motion of the ions under the influence of the applied potentials occurs in three dimensions, x , y and z . The z motion resulting from the kinetic energy of the ions when they enter the quadrupole field. However, due to the cylindrical symmetry $x^2 + y^2 = r^2$, it can also be expressed using z , r coordinates.

Mathieu equation, whose solutions are known, is

$$\beta_u = [a_u + (q_u^2/2)]^{1/2}$$

$$\frac{d^2z}{dt^2} - \frac{4ze}{m(r_0^2 + 2z_0^2)} (U - V \cos \omega t) z = 0$$

$$\frac{d^2r}{dt^2} + \frac{2ze}{m(r_0^2 + 2z_0^2)} (U - V \cos \omega t) r = 0$$

$$\frac{d^2u}{d\xi^2} + (a_u - 2q_u \cos 2\xi)u = 0 \quad \xi = \frac{\omega t}{2},$$

$$a_u = a_z = -2a_r = \frac{-16zeU}{m(r_0^2 + 2z_0^2)\omega^2},$$

$$q_u = q_z = -2q_r = \frac{8zeV}{m(r_0^2 + 2z_0^2)\omega^2}$$

3. Mass Analyzers

3.2 Quadrupole ion traps (contin.).

To have a stable trajectory, the movement of the ions must be such that during this time the coordinates never reach or exceed r_0 (r -stable) and z_0 (z -stable). The complete integration of the **Mathieu equation** by the method of **Floquet and Fourier** requires the use of a function $e^{(\alpha+i\beta)}$. **Real solutions correspond to a continuously increasing, and thus *unstable*, trajectory. Only purely imaginary solutions correspond to *stable trajectories*.** This requires both $\alpha = 0$ and $0 < \beta_u < 1$

$$\beta_u = \left[a_u - \frac{(a_u - 1)q_u^2}{2(a_u - 1)^2 - q_u^2} - \frac{(5a_u + 7)q_u^4}{32(a_u - 1)^3(a_u - 4)} - \frac{(9a_u^2 + 58a_u + 29)q_u^6}{64(a_u - 1)^5(a_u - 4)(a_u - 9)} \right]^{1/2}$$

A simpler approximate equation holds for q_u values lower than 0.4: $\beta_u = [a_u + (q_u^2/2)]^{1/2}$

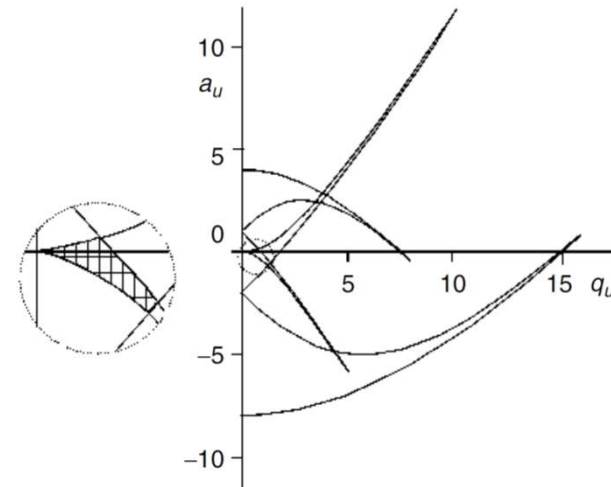
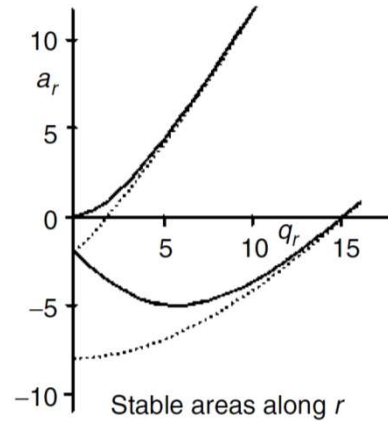
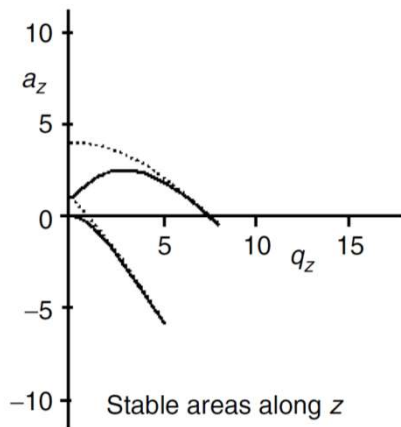

The iso- β lines for $\beta_u = 0$ (solid lines) and $\beta_u = 1$ (dotted lines)

3. Mass Analyzers

3.2 Quadrupole ion traps (contin.).

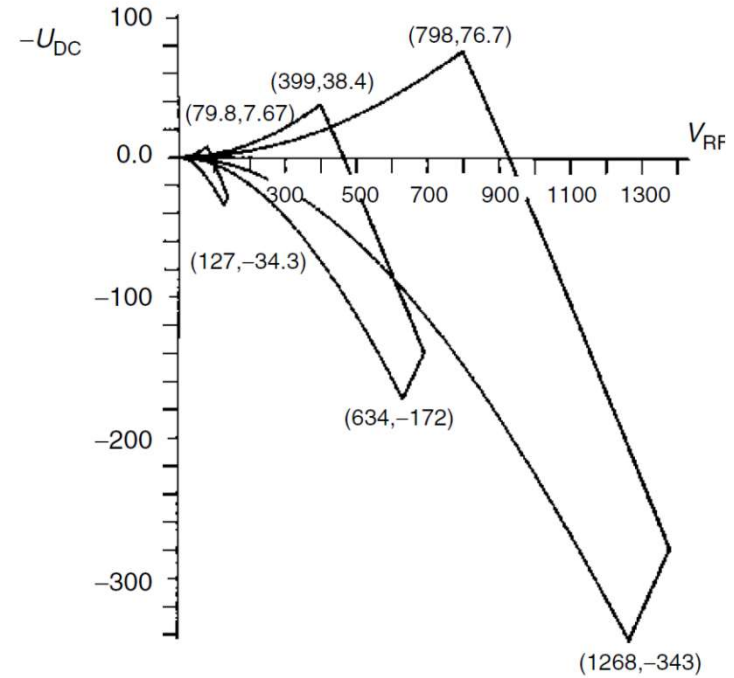
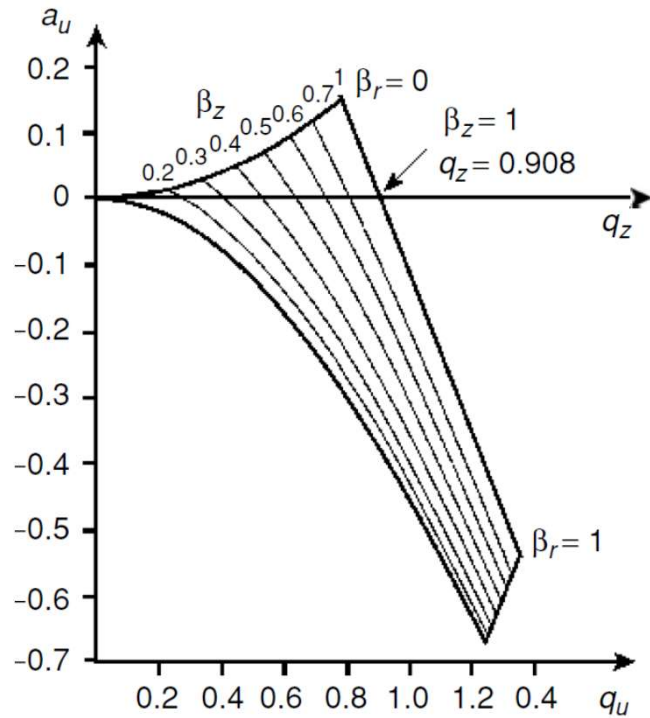

Typical stability diagram for a 3D ion trap. The value at $\beta_z = 1$ along the q_z axis is $q_z = 0.908$. At the upper apex, $a_z = 0.149\ 998$ and $q_z = 0.780\ 909$.

3. Mass Analyzers

3.2 Quadrupole ion traps (contin.).

The ions will not oscillate at this same ‘fundamental’ ν frequency because of their inertia, which causes them to oscillate at a ‘secular’ frequency f , lower than ν , and decreasing with increasing masses. It should be noted that a_u and q_u , and thus β , are inversely proportional to the m/z ratio. $f_z = \beta_z \nu / 2$

As the maximum value of β for a stable trajectory is $\beta = 1$, the maximum secular frequency f_z of an ion will be half the fundamental ν frequency.

The second important parameter which is a function of q_z is the **Dehmelt pseudopotential** well. The trapping efficiency of ions injected in the trap can be described using the pseudopotential well given by the following equation:

$$\overline{D_z} = q_z \frac{V}{8} = \frac{eV^2}{m(r_0^2 + 2z_0^2)\omega^2}$$

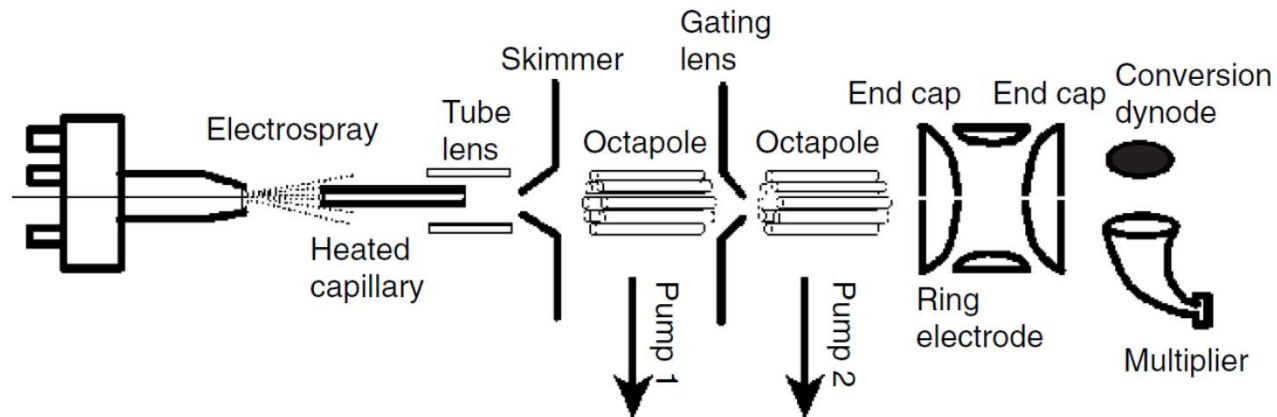

3. Mass Analyzers

3.2 Quadrupole ion traps (contin.).

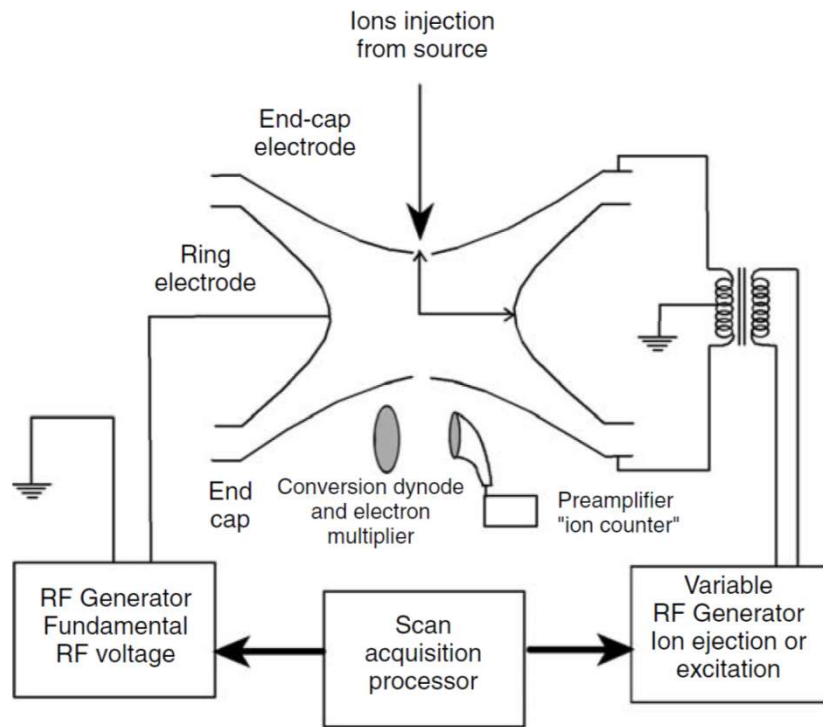

Ion trap with an RF voltage applied to the ring electrode, providing the fundamental frequency ν and its associated variable amplitude V . Instead of injecting ions, electrons may be injected for internal ionization. Variable RF voltage can be applied to the end caps for ion excitation or ion ejection.

As no DC voltage is applied, the 3D trap will be operated along the q_u axis, $a_u = 0$.

q_z is given by the following equation:

$$q_z = \frac{8zeV}{m (r_0^2 + 2z_0^2) \omega^2}$$

q_z will increase if V increases, and decrease if m increases.

3. Mass Analyzers

3.2 Quadrupole ion traps (contin.).

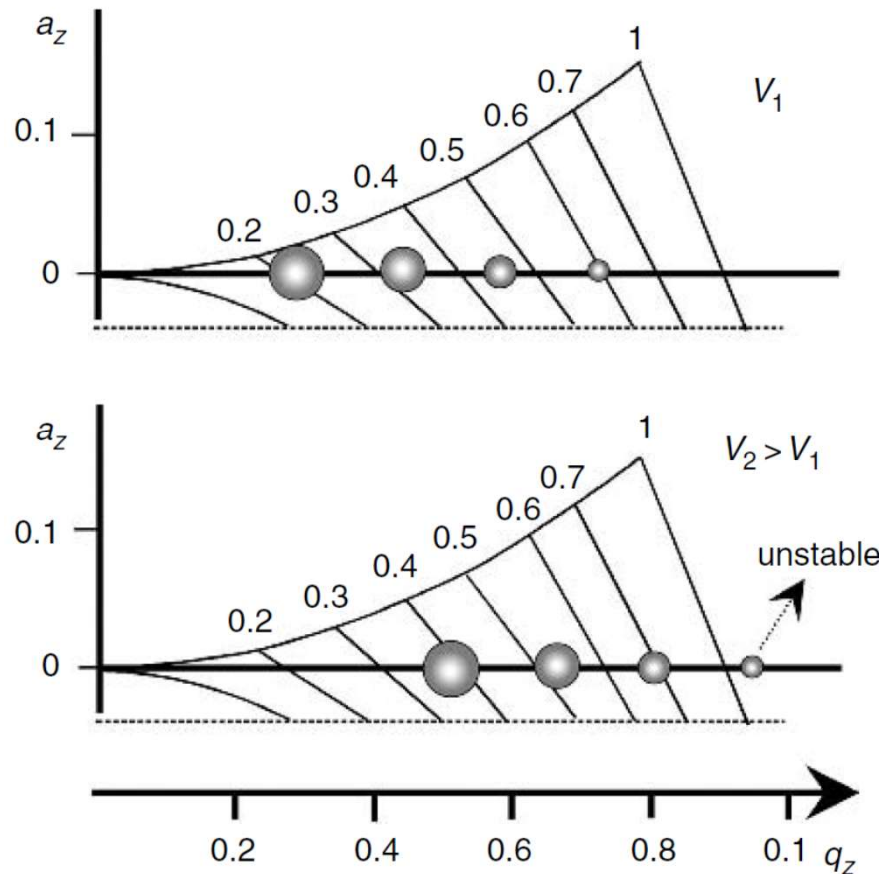

If V is increased, all the ions will have a higher q_z value. If this value is equal to **0.908**, $\beta = 1$, and the ion has reached its stability limit. A slight increase of V will cause this ion to have an unstable trajectory, and will be expelled from the trap in the z direction.

Thus 50% of the expelled ions will reach the detector. This allows the ions present in the trap to be analyzed.

$$q_z = \frac{8zeV}{m(r_0^2 + 2z_0^2)\omega^2} \quad m_{\text{MAX}} = \frac{8ze \cdot 8000}{0.908(r_0^2 + 2z_0^2)(2\pi\nu)^2}$$

See the example at page No. 109 Hoffmann

Thus, besides trying to increase V at higher values without arcing, the maximum observable mass can be increased by reducing the size of the trap or using a lower RF frequency ν .

3. Mass Analyzers

3.3 Time-of-Flight Analyzers (TOF)

Ions acquire the same kinetic energy, i.e. a distribution of their masses presents a distribution of their velocities.

Mass-to-charge ratios are determined by measuring the time that ions take to move through a field-free region between the source and the detector.

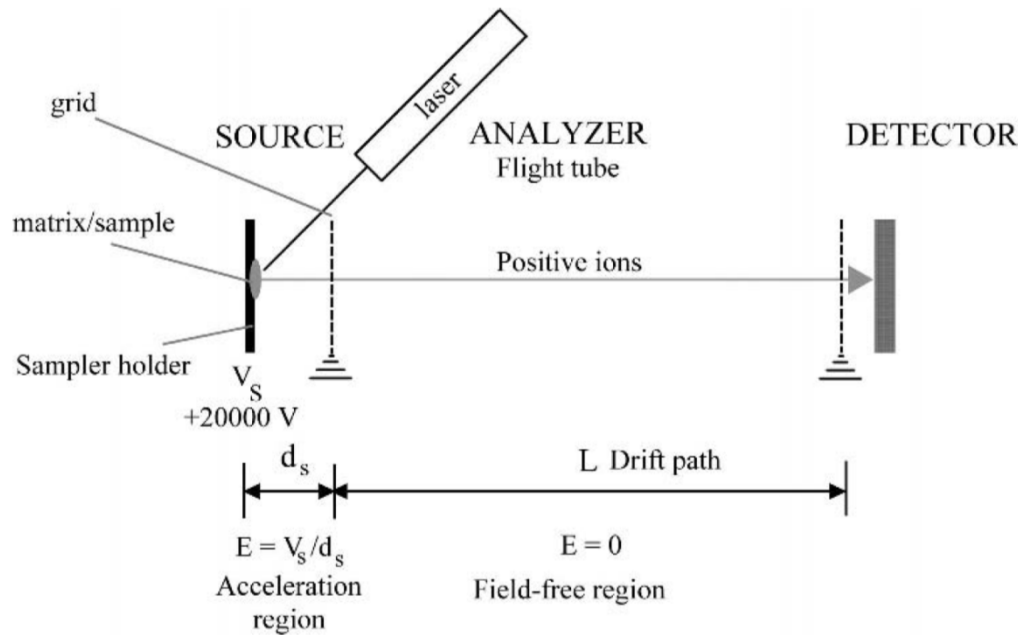

Ion with mass m and total charge $q = ze$ is accelerated in the source by a potential V_S . Its electric potential energy E_{el} is converted into kinetic energy E_k :

$$E_k = \frac{mv^2}{2} = qV_S = zeV_S = E_{el}$$

$$v = (2zeV_S/m)^{1/2} \quad t = \frac{L}{v}$$

$$t^2 = \frac{m}{z} \left(\frac{L^2}{2eV_S} \right)$$

TOF analyser is well suited to the pulsed nature of the laser desorption ionization. The development of matrix-assisted laser desorption/ionization TOF has paved the way for new applications not only for **biomolecules** but also for **synthetic polymers** and **polymer/biomolecule conjugates**.

3.3 Time-of-Flight Analyzers - Calibration

The TOF analyzer should **be mass calibration with two reference points**.

The term in parentheses can be replaced with the constant A .

$$(m/z)^{1/2} = \left(\frac{\sqrt{2eV_s}}{L} \right) t$$

A constant B should be added to produce a simple equation for a straight line. This constant B allows correction of the measured time zero that may not correspond exactly with the true time zero.

$$(m/z)^{1/2} = At + B$$

Therefore, the conversion of flight times to mass supposes a preliminary calibration with two known molecules (standards). Using their known m/z ratios and their measured flight times, this equation is solved for the two calibration constants A and B . As long as the points are not too close together, a simple two-point calibration is usually accurate.

Internal calibration is a method in which the flight times of the standard and unknown ions are measured from the same spectrum providing the best possible match of experimental conditions for the three species involved. The highest degree of mass accuracy is usually achieved through internal calibration.

3.3 Time-of-Flight Analyzers – Pros and cons

- ❑ In principle, the **upper mass range of a TOF instrument has no limit**, which makes it especially suitable **for soft ionization techniques**. For example, samples with masses above 300 kDa have been observed by MALDI-TOF.
- ❑ Another advantage of these instruments is their **high transmission efficiency** (all the formed ions are in principle analyzed contrary to the scanning analyzers that transmit ions successively along a time scale). It leads to very **high sensitivity**. For example, the spectrum from 10^{-15} mol of gramicidin and the detection of 100–200 attomole amounts of various proteins have been obtained with TOF analyzers.
- ❑ The most important **drawback of the TOF analyzers is their poor mass resolution**. Mass resolution is affected by factors that create a distribution in flight times among ions with the same m/z ratio:
 - the length of the ion formation pulse (time distribution),
 - the size of the volume where the ions are formed (space distribution),
 - the variation of the initial kinetic energy of the ions (kinetic energy distribution), and so on.
 - The electronics and more particularly the digitizers, the stability of power supplies, space charge effects and mechanical precision can also affect the resolution and the precision of the time measurement.

3.3 Time-of-Flight Analyzers – Mass resolution improvements

- Because the mass resolution is proportional to the flight time, one solution **to increase the resolution** of the TOF analyzers is to **lengthen the flight tube**.

$$\frac{m}{z} = \left(\frac{2eV_s}{L^2} \right) t^2 \quad \frac{1}{z} dm = \left(\frac{2eV_s}{L^2} \right) 2t dt \quad \frac{m}{dm} = \frac{t}{2dt} \quad R = \frac{m}{\Delta m} = \frac{t}{2\Delta t} \approx \frac{L}{2\Delta x}$$

Δm and Δt are the peak widths measured at the 50% level on the mass and time scales, respectively and Δx is the thickness of an ion packet approaching the detector.

- It is possible also to decrease the flight time by **lowering the acceleration voltage** but it reduces sensitivity.
- So, the only way **to have both, high resolution and high sensitivity**, is to **use a long flight tube** with a length of **1 to 2 m** for a higher resolution and an **acceleration voltage** of at least **20kV** to keep the sensitivity high.
- To improve the mass resolution two techniques were developed: **delayed pulsed extraction** and the **reflection** (see next two slides).

3.3 Time-of-Flight Analyzers – delayed pulsed extraction

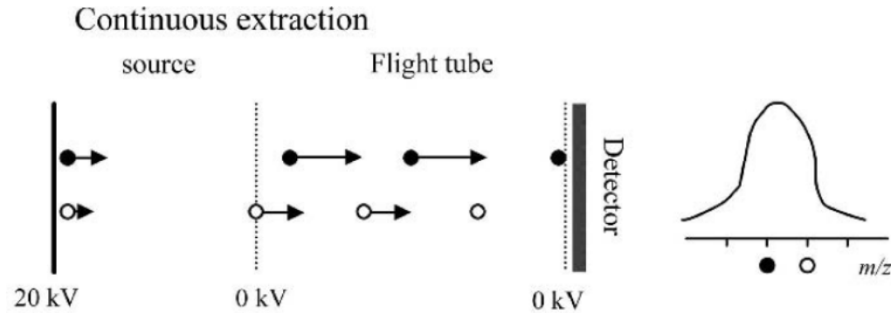

In the continuous extraction mode the ions with the same m/z ratio but with different kinetic energy reach the detector at slightly different times, resulting in peak broadening.

Delayed Pulsed Extraction

Delayed pulsed extraction

1) ion production



2) ion extraction

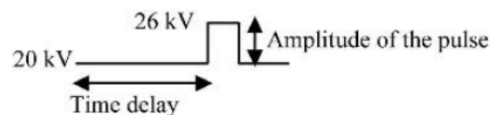
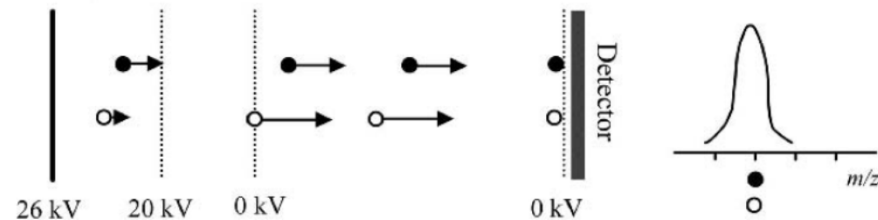

The extraction pulse applied after a certain delay transmits more energy to the ions which remained for a longer time in the source.

→ the initially less energetic ions receive more kinetic energy and join the initially more energetic ions at the detector.

Energy focusing can be accomplished by adjusting the amplitude of the pulse and the time delay between ion formation and extraction.

For optimal focusing, both the pulse and the delay is adjusted separately, and it is **mass dependent**. Lower pulse voltages or shorter delays are required to focus ions of lower m/z ratio.

3.3 Time-of-Flight Analyzers - Reflectrons

Another way to improve mass resolution is to use an electrostatic reflector also called a reflectron. It creates a retarding field that acts as an ion mirror by deflecting the ions and sending them back through the flight tube. Reflectron consists usually of a series equally spaced grid electrodes or more preferably ring electrodes connected through a resistive network of equal-value resistors.

Reflectron

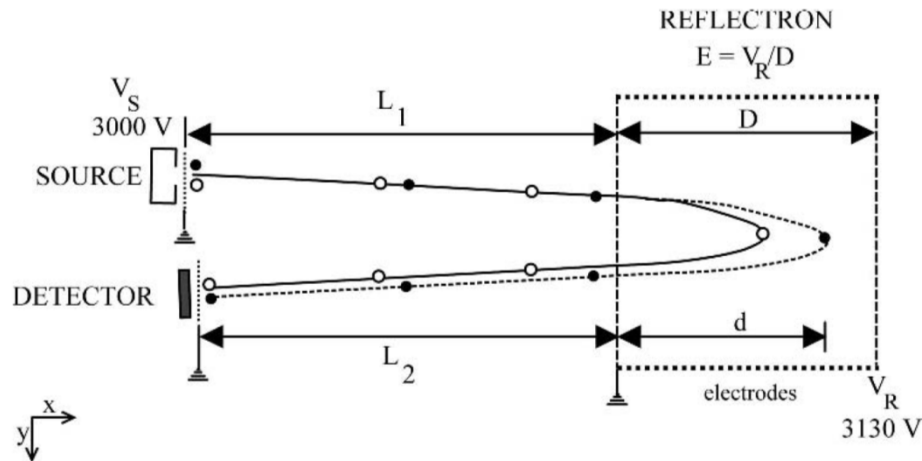

- ❑ Ions with more kinetic energy and hence with more velocity will penetrate the reflectron more deeply than ions with lower kinetic energy. →

Consequently, the faster ions will spend more time in the reflectron and will reach the detector at the same time than slower ions with the same m/z – correction of the initial kinetic energy dispersion (see next slide)

- ❑ The reflectron increases the mass resolution at the expense of sensitivity and introduces a mass range limitation.

The performance of the reflectron may be improved by using a **two-stage reflectron**, to reduce the size and to improve the homogeneity of the electric field. In this reflectron, two successive homogeneous electric fields of different potential gradient are used. The first stage is characterized by an **intense electric field** responsible for the strong deceleration of the ions while the second stage is characterized by a **weaker field**.

These two-stage reflectrons have the advantage of being more compact devices because of the strong deceleration of the ions at the first stage, but they suffer from a lower transmission.

3.3 Time-of-Flight Analyzers - Reflectrons

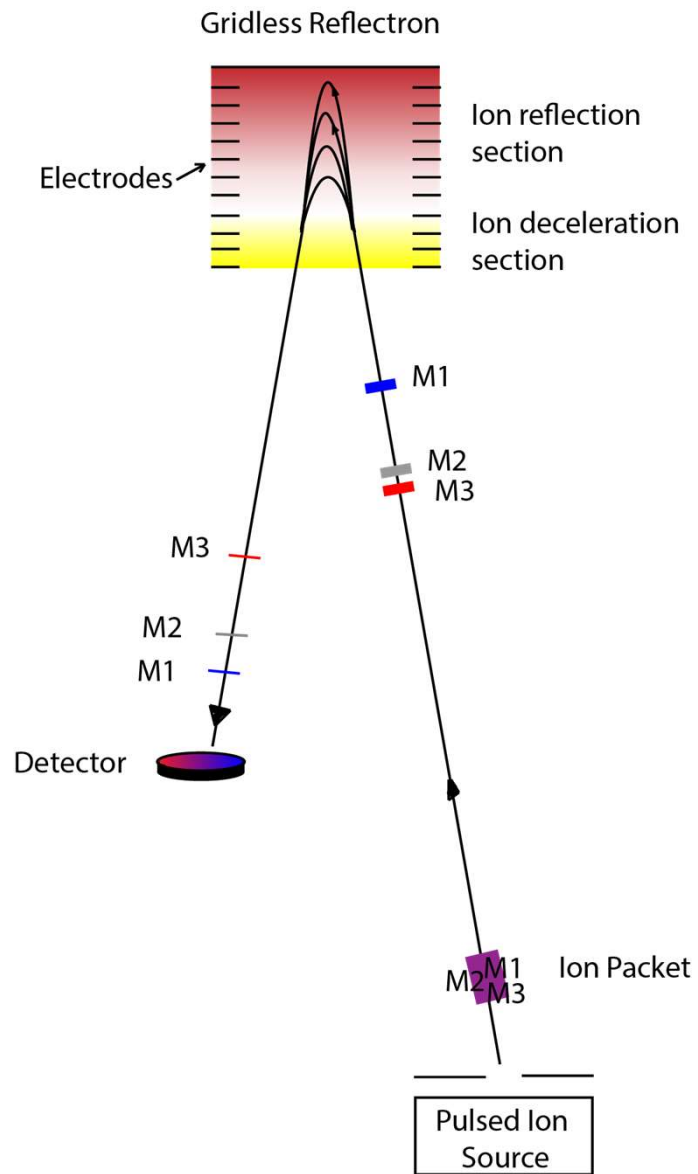

□ Ions with more kinetic energy and hence with more velocity will penetrate the reflectron more deeply than ions with lower kinetic energy. →

Consequently, the faster ions will spend more time in the reflectron and will reach the detector at the same time than slower ions with the same m/z – correction of the initial kinetic energy dispersion



view down the reflectron

3. Mass Analyzers

3.4 Magnetic and Electromagnetic Analyzers

Action of the magnetic field

$$F_M = qvB \quad qvB = \frac{mv^2}{r} \quad \text{or} \quad mv = qBr$$

$$\frac{1}{2}mv^2 = qV_s \quad \frac{m}{q} = \frac{r^2 B^2}{2V_s}$$

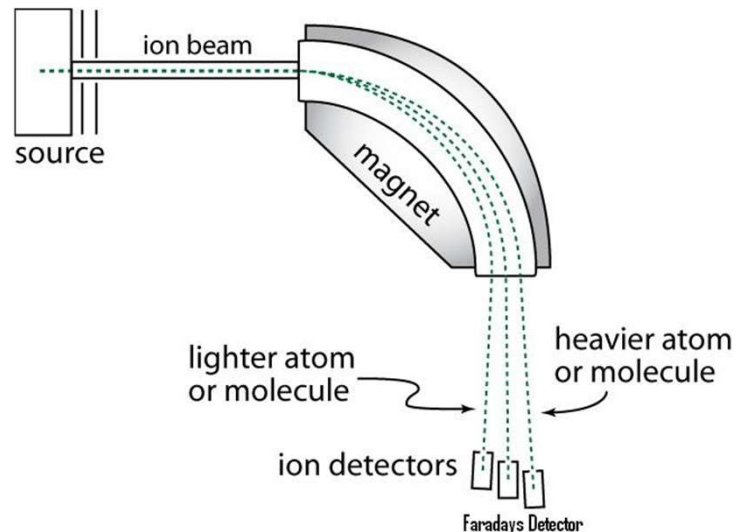

If the radius r is imposed by the presence of a flight tube with a fixed radius r , for a given B only ions with corresponding m/q go through.

➡ **Changing B as a function of time allows successive observations of ions with various values of m/q provided that they all have the same kinetic energy.** The **magnetic analyzer is fundamentally a momentum analyzer** and can be used as a mass analyzer provided that the kinetic energy of the ions or at least their velocity is known. The kinetic energy can be controlled with an electrostatic analyzer (*next slide*).

Instead of positioning a guide tube and detecting the ions successively while scanning the magnetic field, it is also possible to use the characteristic that ions with the same kinetic energy but different m/q ratios have trajectories with different r values. Such ions emerge at different positions (these instruments are said to be dispersive).

3.4 Electromagnetic Analyzers – Electrostatic field

Suppose a radial electrostatic field E is produced by a cylindrical condenser. The trajectory is then circular and the velocity is constantly perpendicular to the field.

$$qE = \frac{mv^2}{r}$$

Introducing the entrance kinetic energy E_k

$$r = \frac{2E_k}{qE}$$

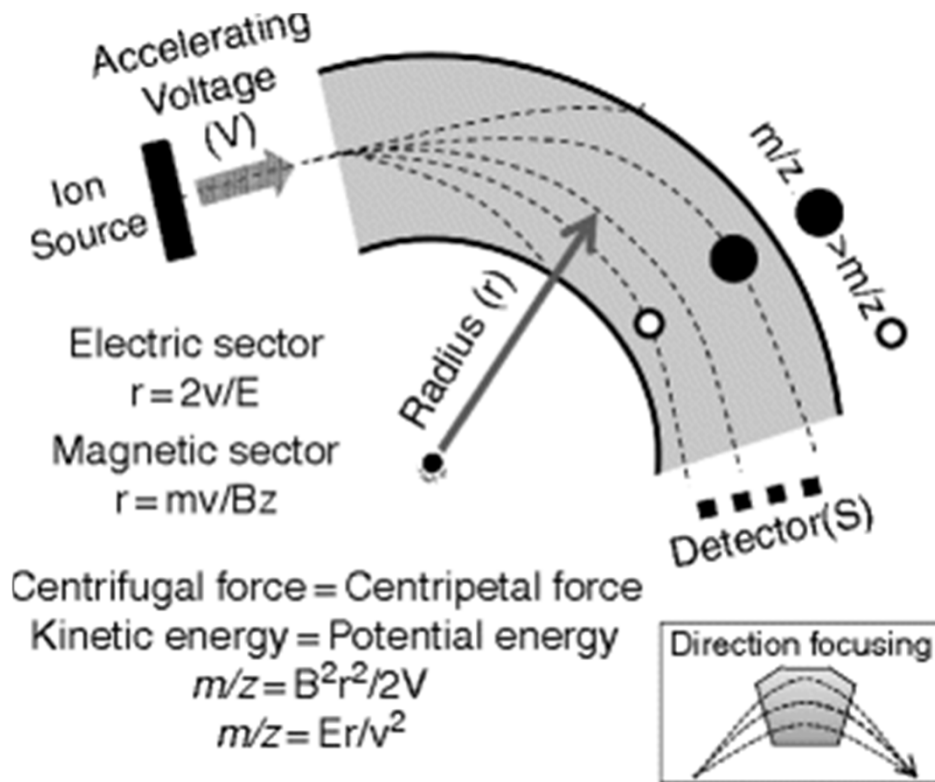

Since the trajectory is independent of the mass, the **electric field is** not a mass analyzer, but rather a **kinetic energy analyzer**, just as the magnetic field is a momentum analyzer.

The electric sector separates the ions according to their kinetic energy.

3.4 Electromagnetic Analyzers – Dispersion and resolution

Resolution depends inversely on the dispersion at the analyzer outlet. **Three factors favor the dispersion, and thus the loss of resolution:**

1. If the ions entering the field **do not have the same kinetic energy**, they follow **different trajectories** through the field. This is called **energy dispersion**.
2. If the ions entering the field follow **different trajectories**, this divergence may increase during the trip through the field. This is called **angular dispersion**.
3. The incoming ions do not originate from one point, but from a **slit**. The magnetic or electric field can only yield, at best, a picture of that slit. The picture width depends on the width of the slit and on the magnifying effect of the analyzer.

energy dispersion

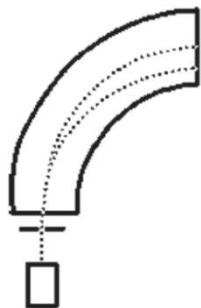

angular dispersion

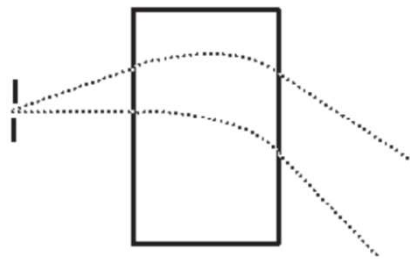

3.4 Electromagnetic Analyzers – Direction focusing

Direction focusing in a magnetic sector

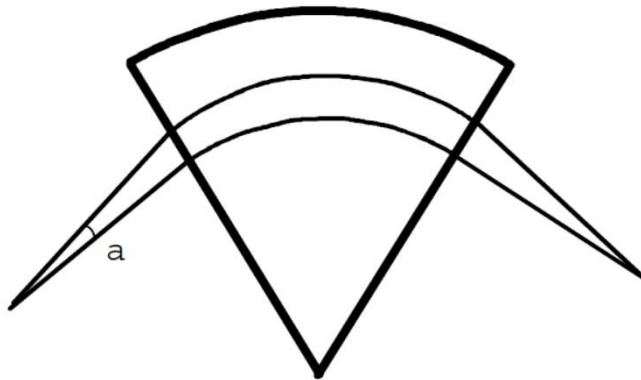

Direction focusing in an electric sector

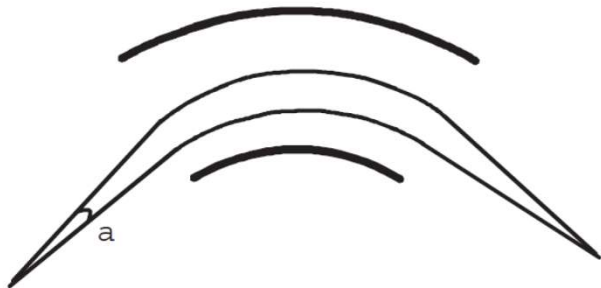

- An ion entering the magnetic field along a trajectory perpendicular to the field edge follows a circular trajectory. An ion **entering at an angle α** with respect to the previous perpendicular trajectory **follows a circular trajectory with an identical radius** and thus converges with the previous ion when emerging from the sector.

➡ Choosing correctly the geometry of the magnetic field (sector field) allows focusing of the incoming beam.

- An ion entering the electric sector perpendicular to the field edge follows a curved trajectory. However, if the ion **trajectory at the inlet is not perpendicular to the edge**, its trajectory is **longer if it enters the sector closer to the outside** and **shorter if it enters the sector closer to the inside**.

➡ A suitably chosen geometry results in a direction focusing

3.4 Electromagnetic Analyzers – Energy focusing

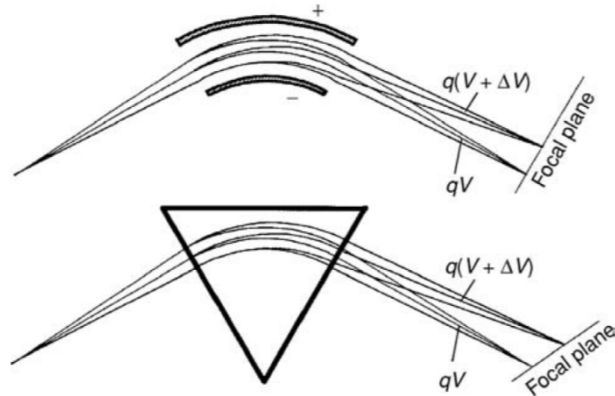

When a beam of ions with different kinetic energies issues from the source, the electric and magnetic sectors produce an **energy dispersion** and a **direction focusing**.

If two sectors with the same energy dispersion are oriented as shown below, the **first sector energy dispersion is corrected by the second sector convergence**.

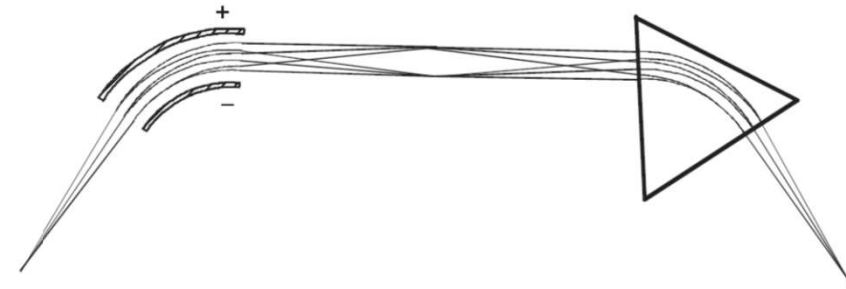
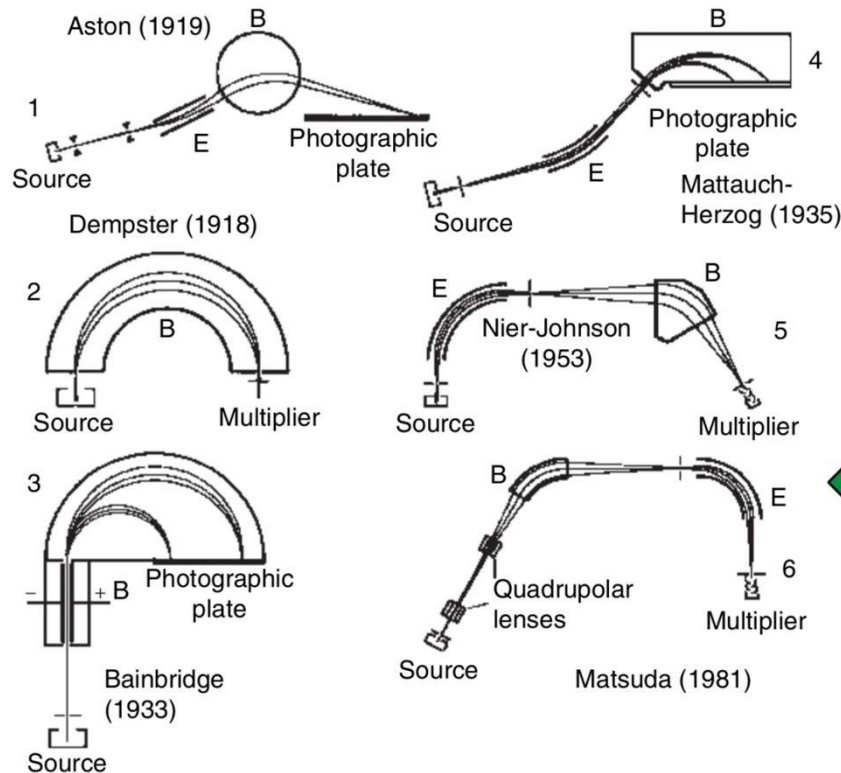

← **Double-focusing instruments** use this principle (B - magnetic sector, E - electric sector)
Instruments 4, 5 and 6 are mostly used.

3.4 Electromagnetic Analyzers – Practical considerations

- ❑ The **magnetic** instrument's sources must **function with potentials V_s of about 10 kV**. The **vacuum in the source must thus be very high** to avoid arcing.
- ❑ **Classical magnets** were not well suited to fast scanning because of the **hysteresis phenomenon** and the **magnet heating up** by the **Foucault currents** induced by rapidly changing magnetic fields. **Lamellar magnets** avoid such inconveniences; they have been well developed and are now widely used.
- ❑ **Magnetic instruments function at constant resolution $R = m/\delta m$** . As a result, **δm is proportional to m** . Consider $R = 1000$; ion $m_1 = 100$ ($\delta m_1 = 0.1$) is observed while scanning from mass 99.95 to 100.05, whereas for ion $m_2 = 1000$ ($\delta m_1 = 1$) masses range from 999.5 to 1000.5. If the scanning is carried out to cover a mass unit within a time t , the ion m_1 is observed during $0.1t$, whereas m_2 during $1t$. Since detection time interval differ, **the number of detected ions does not correspond to the number of ions produced**  **scanning time decreases exponentially to correct for this error**.
- ❑ **Method to increase the mass precision: peak matching technique** consists of comparing the masses of two compounds that are simultaneously ionized in the spectrometer source: one is unknown and its exact mass is sought; the other is a reference and its mass is known with accuracy. **This comparison is achieved by a very rapid alternative modification of the acceleration voltage to focus the two ions, the intensities of the magnetic and electric fields being kept constant**. The match is perfect when the two mass profiles exactly overlap. If the acceleration voltages necessary for the focusing of the two ions are known with accuracy, the mass of the unknown compound can be determined with accuracy.

4. Detectors

Detectors are able to generate from the incident ions an electric current that is proportional to their abundance.

A variety of approaches are used to detect ions:

- ❑ The measurement of direct charge current that is produced when an ion hits a surface and is neutralized (**Farraday cup**).
- ❑ The kinetic energy transfer of incident ions by collision with a surface that in turn generates secondary electrons, which are further amplified to give an electronic current (**electron multipliers or electro-optical ion detectors**). Because the number of ions leaving the mass analyzer at a particular instant is generally quite small, significant amplification is often necessary to obtain a usable signal. Indeed, 10 incident ions per second at the detector corresponds to an electric current of 1.6×10^{-18} A.
- ❑ the detector consists of a pair of metal plates within the mass analyzer region close to the ion trajectories. Ions are detected by the image current that they produce in a circuit connecting the plates (**image current detectors** at FTICR or orbitrap).

Ion detectors can be divided into two classes:

1. **point ion collectors**: made to count ions of a single mass at a time and therefore they detect the arrival of all ions sequentially at one point.
2. **array collectors**: ability to count multiple masses and detect the arrival of all ions simultaneously along a plane (photographic plates, image current detectors or array detectors).

Efficiency of detectors generally decreases exponentially when the mass of the ion increases.

4. Detectors

4.1 Photographic Plate & Faraday Cup

Photographic Plate

Ions sharing the same m/z ratio all reach the plate at the same place and the **position of the spots** allows the determination of their m/z values after calibration. The **darkness of the spots** gives an approximate value of their relative abundance. This detector, which allows simultaneous detection over a large m/z range, has been used for many years but **is obsolete today**.

Faraday Cup

measures a direct charge current that is produced when an ion hits a surface and is neutralized.

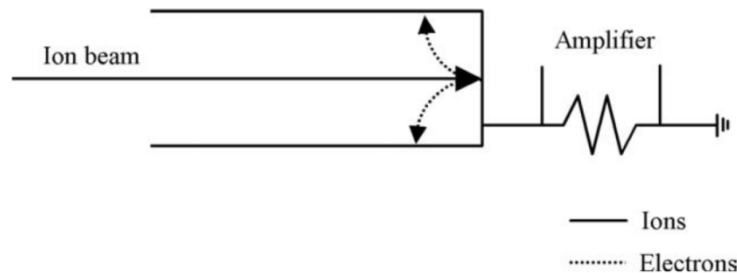

Because the charge associated with an electron leaving the wall of the detector is identical to the arrival of a positive ion at this detector, **secondary electrons emitted when an ion strikes the wall of the detector are an important source of errors.**

The accuracy of this detector can be improved by suppression of secondary electrons and preventing the escape of reflected ions and secondary electrons. The cup is coated with **carbon** because it produces few secondary ions. The **shape** of the cup and the use of a **weak magnetic field** prevent also any secondary electrons produced inside to exit.

The disadvantages of this simple and robust detector are its **low sensitivity** and its **slow response** time.

4. Detectors

4.2 Electron multipliers (EMs) - discrete dynode

Electron multiplier - The most widely used ion detector in mass spectrometry.

The **discrete dynode electron multiplier** is made up of a **series of 12 to 20 dynodes** that have good secondary emission properties. Ions from the analyzer are accelerated to a high velocity towards an electrode (**conversion dynode**) held at a **high potential from ± 3 to ± 30 kV** (polarity depends on the charge of the detected ions).

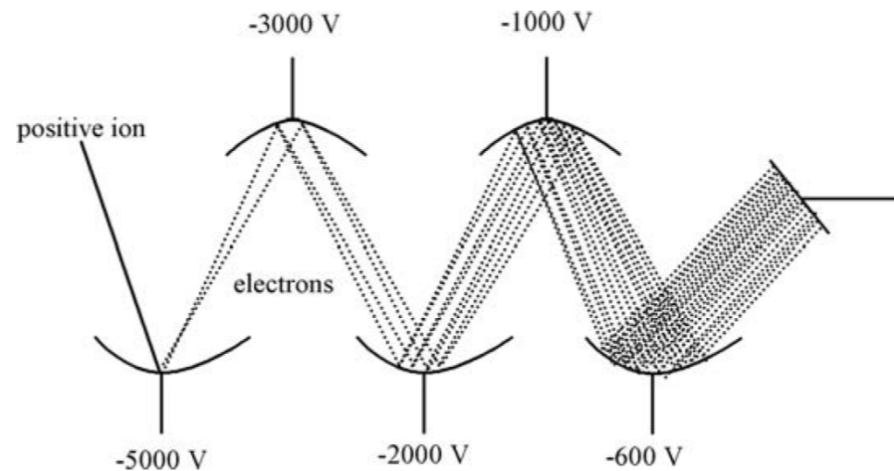

A positive or negative ion striking the conversion dynode causes the **emission of several secondary particles**. When **positive ions** strike the negative high-voltage conversion dynode, the **secondary particles of interest are negative ions and electrons**. When **negative ions** strike the positive high-voltage conversion dynode, the **secondary particles of interest are positive ions**.

The **secondary particles are converted to electrons at the first dynode**. A **cascade of electrons** is created and the final flow of electrons provides an electric current at the end of the electron multiplier that is then increased by conventional electronic amplification.

4.2 Electron multipliers - Channeltron

A type of **continuous-dynode** electron multipliers (CDEM), which is called a **channeltron**, is made from a **lead-doped glass with a curved tube shape** that has good secondary emission properties.

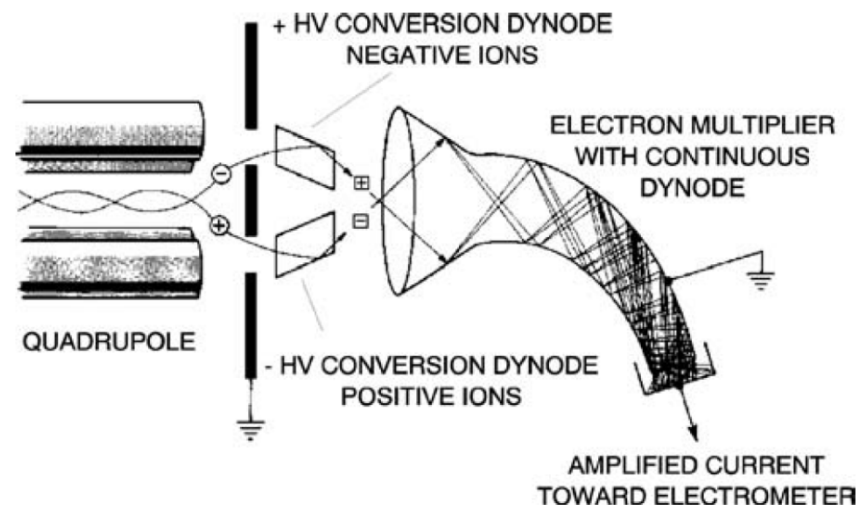

- ❑ The **amplifying power** is the product of the **conversion factor** (number of secondary particles emitted by the conversion dynode for one incoming ion) and the **multiplying factor** of the continuous dynode electron multiplier.
- ❑ The lifetime is limited to 1 or 2 years because of surface contamination from the ions or from a relatively poor vacuum.
- ❑ The **conversion factor is highly dependent on the impact velocity** of the detected ions and on **their nature** (mass, charge and structure), so these detectors are not as precise as Faraday cups.
- ❑ Because of their slower velocity, large ions produce fewer secondary electrons and thus the efficiency decreases when the mass of the ion increases. **The conversion dynodes kept at high potential reduce the mass discrimination effect**, especially with mass analyzers delivering ions at low kinetic energy, such as quadrupoles or ion traps.

4.2 Electron multipliers - Microchannel plate (MCP)

MCP is a **plate in which parallel cylindrical channels** have been drilled. The channel diameter ranges from 4 to 25 μm with a centre-to-centre distance ranging from 6 to 32 μm and a few millimetres in length.

The plate input side is kept at a negative potential of about 1 kV compared with the output side.

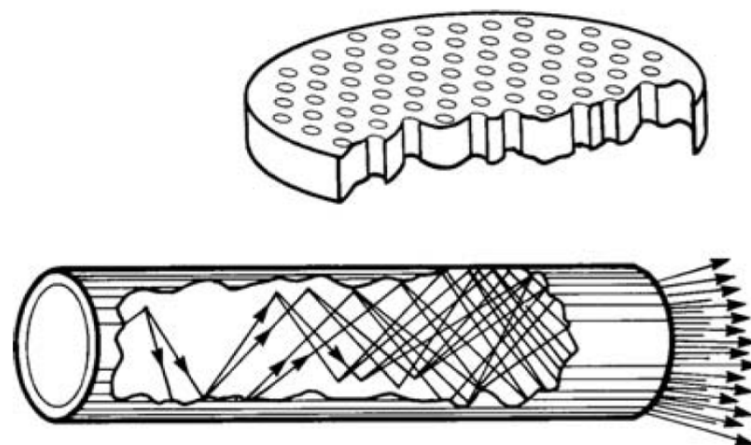

- ❑ **Electron multiplication is ensured by a semiconductor substance covering each channel and giving off secondary electrons.**
- ❑ The snowball effect within a channel can multiply the number of electrons by 10^5 . A plate allows an **amplification of 10^2 – 10^4** , whereas by using several plates the amplification can reach 10^8 .
- ❑ This detector is characterized by a **very fast response time** because the secondary electron path inside the channel is very short. In consequence, it is well suited to TOF analyzers, which need precise arrival times and narrow pulse widths.
- ❑ The **large detection area** of the microchannel plate allows the detection of large ion beams from the analyzer without additional focalization.
- ❑ They are **fragile, sensitive to air** and large microchannel plates are **expensive**.

4.2 Electron multipliers - Microsphere plate (MSP)

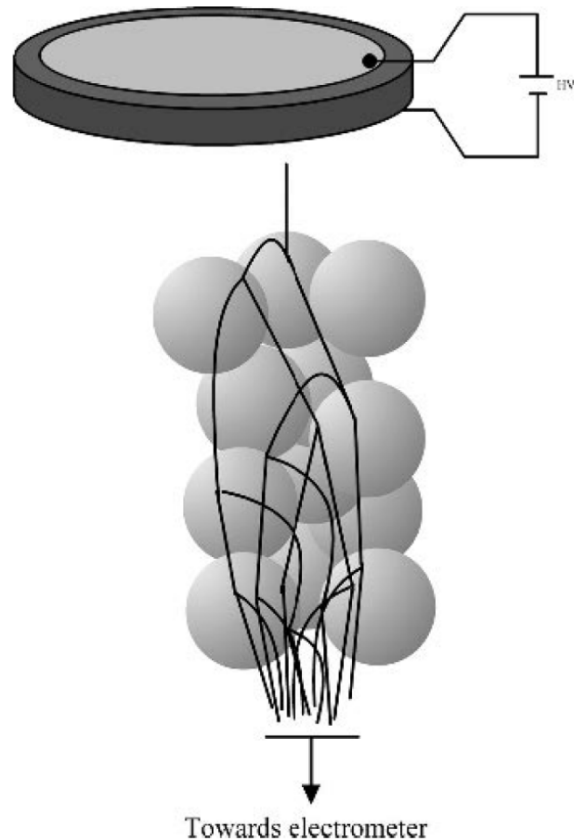

MSP electron multiplier consists of **glass beads with diameters from 20 to 100 μm that are sintered to form a thin plate** with a thickness of 0.7 mm.

- ❑ This plate is porous with irregularly shaped channels between the planar faces. The **surfaces of the beads are covered with an electron emissive material** and the two sides of the plate are coated to make them conductive.
- ❑ A potential difference 1.5–3.5 kV is applied across the plate, with the output side of the plate at the more positive potential.
- ❑ The microsphere plate offers some advantages over the microchannel plate:
 - **less expensive,**
 - **gain is higher, 10^6 – 10^7 ,** because nearly the **entire surface of the input side is active** and therefore emits secondary electrons that will be accelerated onto and through the plate to give the final signal. *In comparison, the surface of the microchannel plate between the microchannels, which corresponds to about 50% of the entire surface, is inactive.*

4. Detectors

4.3 Electro-Optical Ion Detectors

Conversion of ions to electrons and then to photons.

The most common - the **Daly detector**: **two conversion dynodes**, **scintillation or phosphorescent screen** and **photomultiplier**. Detection of positive and negative ions. In the **positive mode**, ions are **accelerated towards the negative dynode**, whereas in the **negative mode** towards the **positive dynode**. **Secondary electrons** that are given off are then **accelerated towards the phosphorescent screen emitting photons**. The photons are detected by the **photomultiplier**.

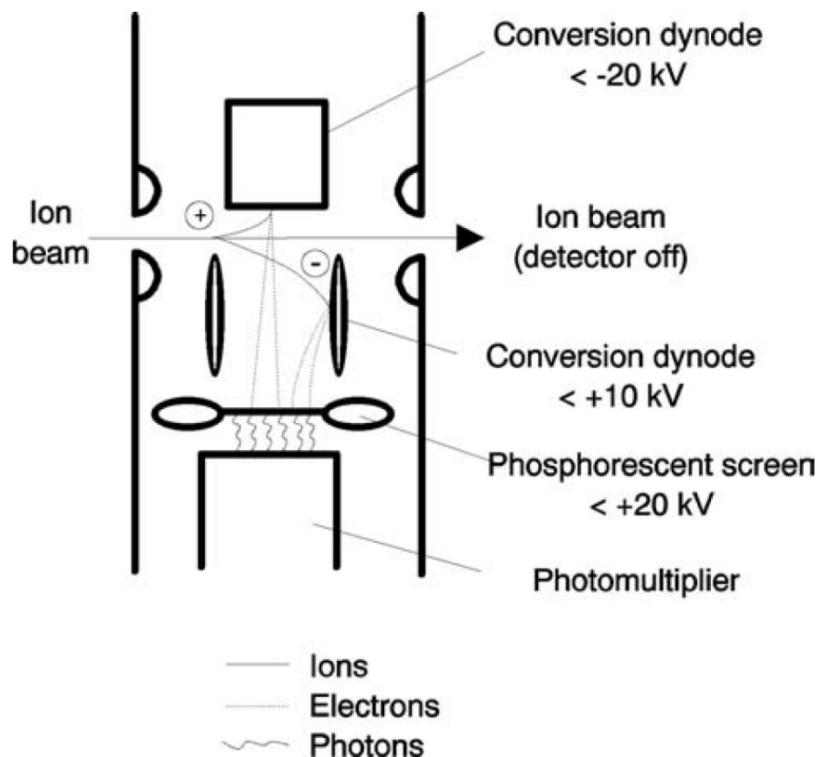

- ❑ The phosphorescent screen surface is covered with a thin layer of aluminum conductor to avoid the formation of a charge that would prevent new electrons from reaching it.
- ❑ Its lifetime is longer than the lifetime of electron multipliers because the photomultiplier is sealed in glass and held under vacuum.
- ❑ It has a **fast response time** and a **similar sensitivity to electron multipliers with an amplification $10^4 - 10^5$** .

Another electro-optical ion detector is the **electro-optical array detector**: allows the simultaneous measurement of ions spatially separated along the focal plane of the mass spectrometer. It **combines the microchannel plate and Daly detector**.