

Buněčné regulace II

Základní morfogenetické dráhy – Hedgehog, Notch, BMP a RTK

Vítězslav Bryja

Klíčové molekulární komponenty vývoje

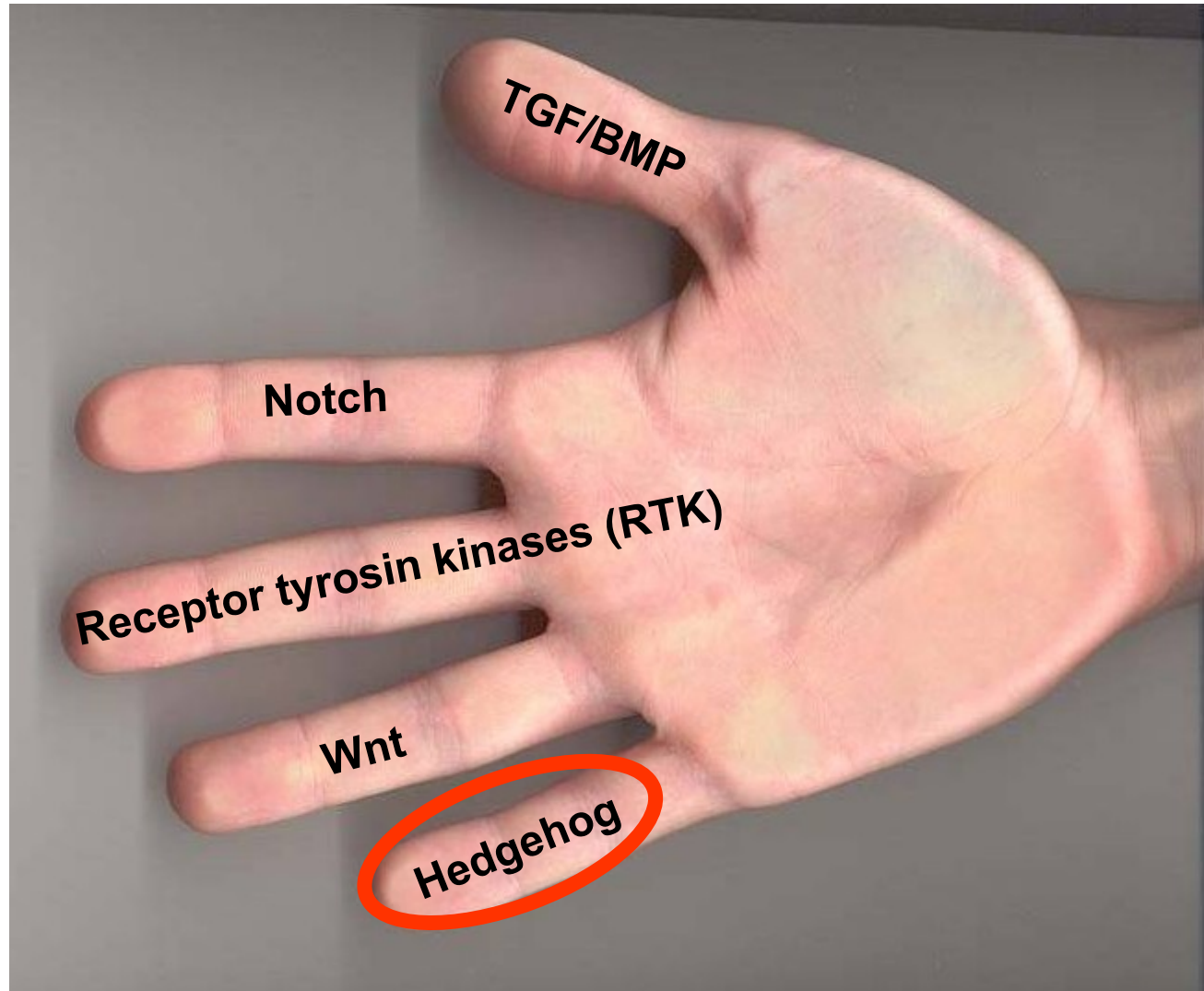

Hedgehog dráha

- hedgehog (Hh) u octomilky – název „ježek“ podle fenotypu larvy
- u savců jsou tři homology:
 - sonic hedgehog (Shh)
 - indian hedgehog (Ihh)
 - desert hedgehog (Dhh)

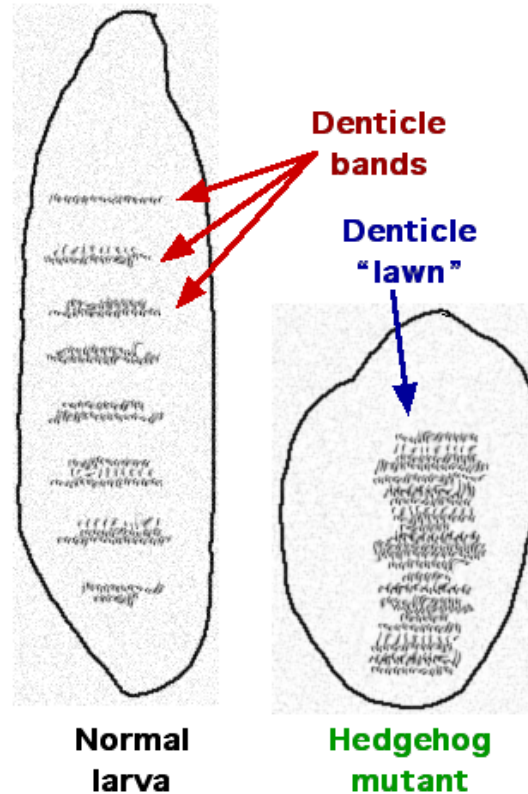

Sonic the Hedgehog

The hedgehog gene (hh) was first identified in the fruit-fly *Drosophila melanogaster* in the classic Heidelberg screens of Christiane Nüsslein-Volhard and Eric Wieschaus, as published in 1980. These screens, which led to them winning the Nobel Prize in 1995 along with developmental geneticist Edward B. Lewis, identified genes that control the segmentation pattern of the *Drosophila* embryos.

Schéma Shh dráhy

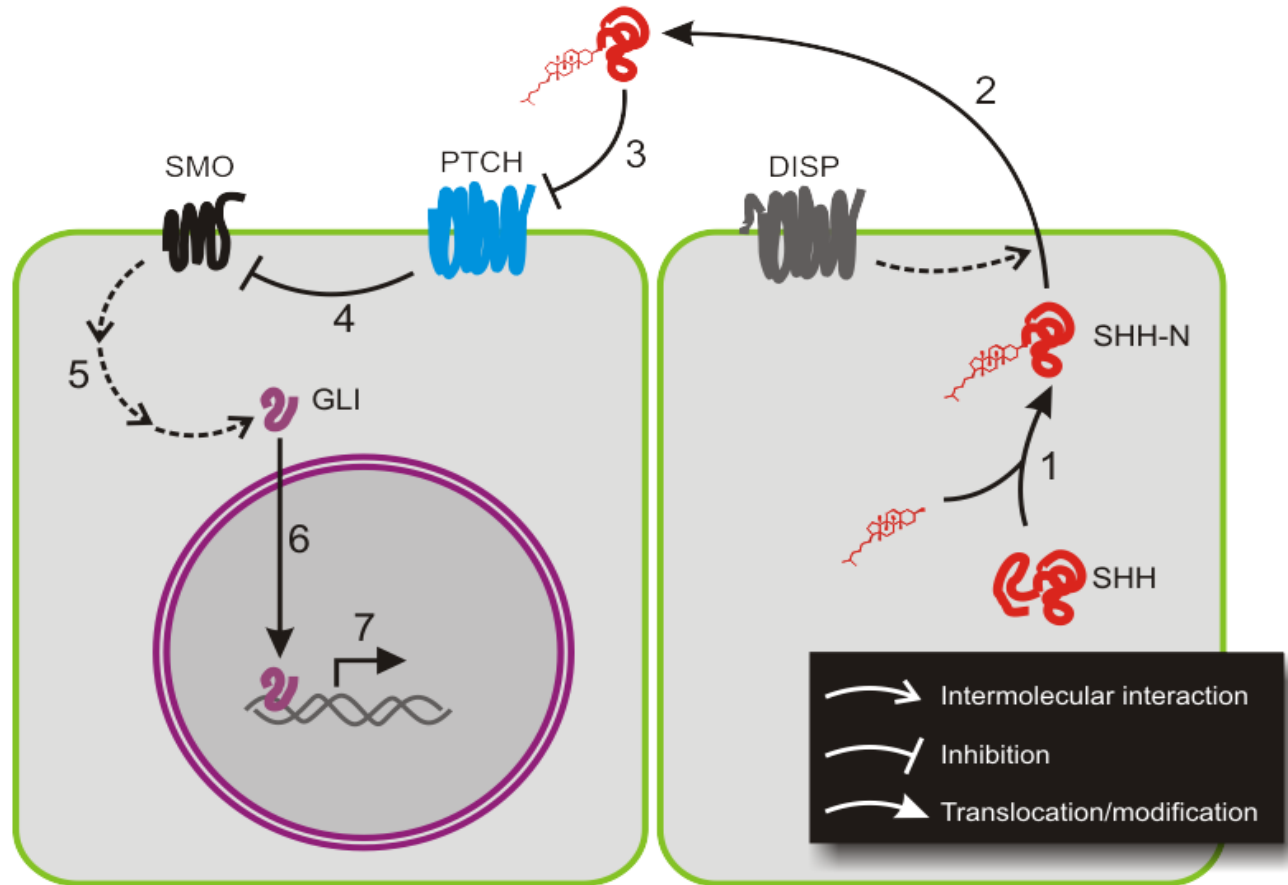

- Sonic hedgehog (SHH) je modifikován oxysterolem a pro sekreci vyžaduje protein Dispatched (Disp)
- Shh váže Patched (PTCH), který je za normálních okolností inhibítozem Smoothened (SMO), po vazbě Shh je tato inhibice přerušena
- Uvolnění SMO umožňuje aktivaci transkripčních faktorů z rodiny GLI, které se přesouvají do jádra a spouští transkripci

Schéma Shh dráhy

- legenda k obrázku:

Sonic hedgehog (SHH) is translated as a ~45kDa precursor and undergoes autocatalytic processing to produce an ~20kDa N-terminal signaling domain (referred to as SHH-N) and a ~25kDa C-terminal domain with no known signaling role (1 on figure 5). During the cleavage, a cholesterol molecule is added to the carboxyl end of the N-terminal domain, which is involved in trafficking, secretion and receptor interaction of the ligand. When SHH reaches its target cell, it binds to the Patched-1 (PTCH1) receptor(3). In the absence of ligand, PTCH1 inhibits Smoothed (SMO), a downstream protein in the pathway(4). It has been suggested that SMO is regulated by a small molecule, the cellular localisation of which is controlled by PTCH. PTCH1 has a sterol sensing domain (SSD), which has been shown to be essential for suppression of Smo activity. A current theory of how PTCH regulates SMO is by removing oxysterols from SMO. PTCH acts like a sterol pump and remove oxysterols that have been created by 7-dehydrocholesterol reductase. Upon binding of a Hh protein or a mutation in the SSD of PTCH the pump is turned off allowing oxysterols to accumulate around SMO. This accumulation of sterols allows SMO to become active or stay on the membrane for a longer period of time. The binding of SHH relieves SMO inhibition, leading to activation of the GLI transcription factors(5): the activators Gli1 and Gli2 and the repressor Gli3. The sequence of molecular events that connect SMO to GLIs is poorly understood. Activated GLI accumulates in the nucleus(6) and controls the transcription of hedgehog target genes(7).

Shh – učebnicový morfogen

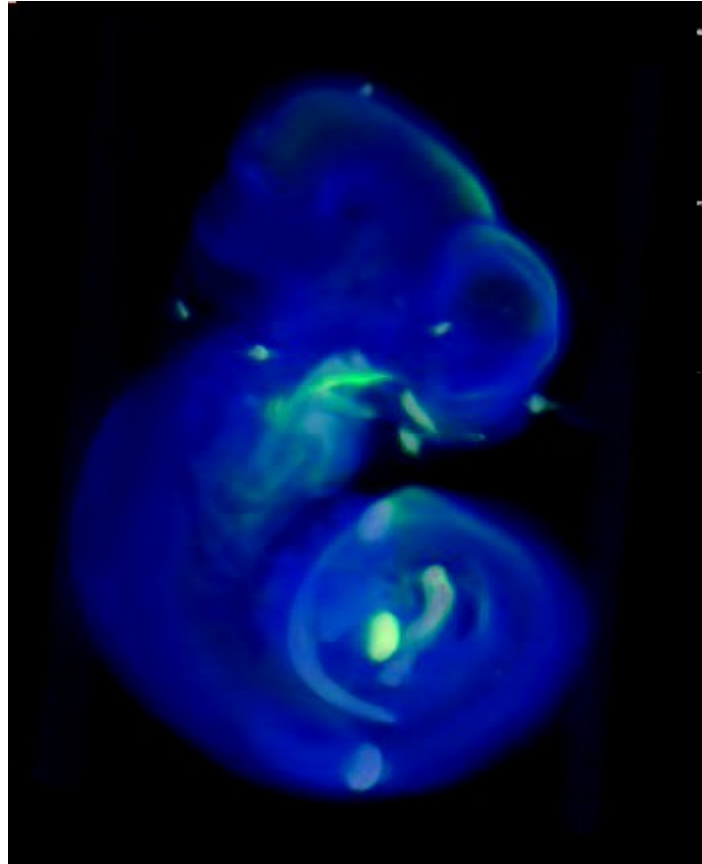

Např. specifikace jednotlivých prstů končetiny

Shh

Shh = jeden z nejlépe popsáných klasických morfogenů (tzv. **model francouzské vlajky**) – v závislosti na koncentraci morfogenu se spouští odlišné transkripční programy

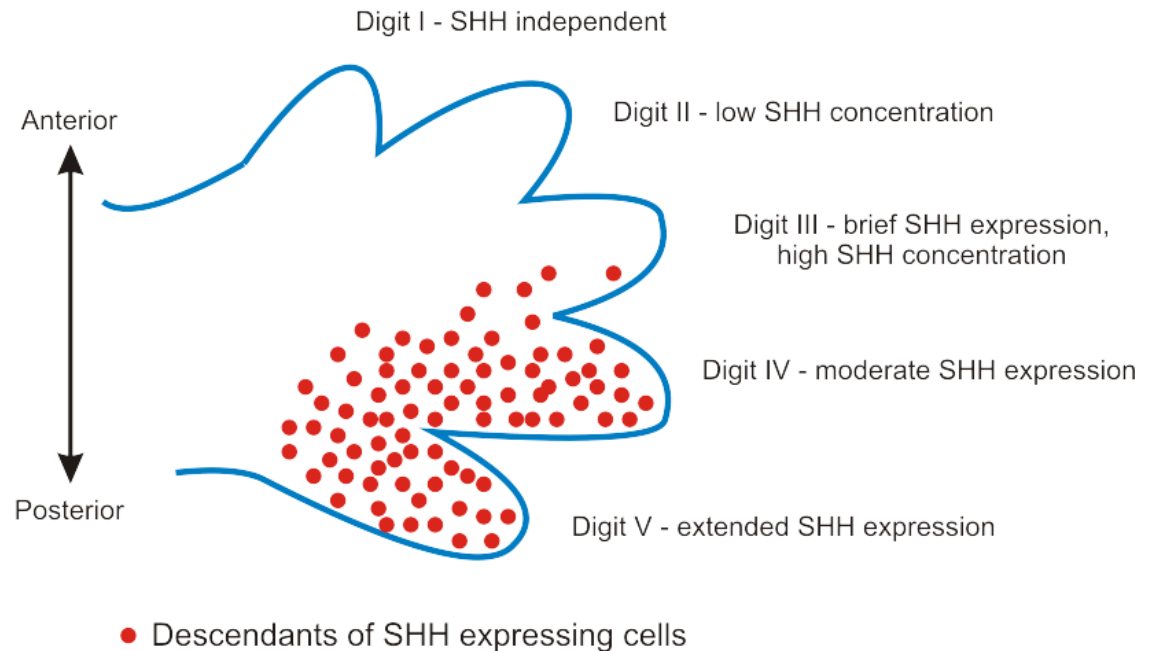

Např. specifikace jednotlivých prstů končetiny

Přirozené inhibitory Shh dráhy



cyclopamin – teratogenní alkaloid z kýchavice (*Veratrum californicum*), poprvé identifikován jako látku způsobující kyklopii (= 1 oko) a holoprosencephalii u ovcí

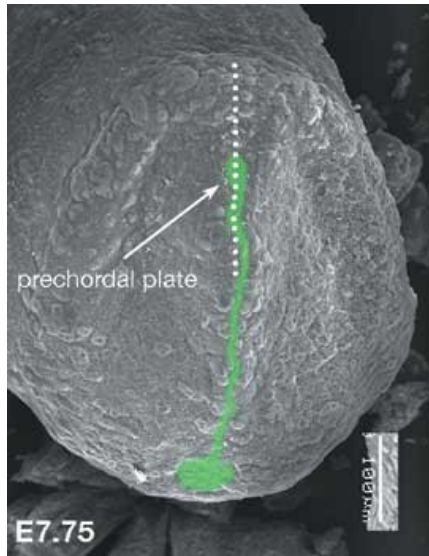

Expression of Sonic hedgehog (Shh) protein and the determination of the midline structure in mouse embryo.

An SEM micrograph of the frontal view of a mouse embryo (fetal age 7.75 days). Shh protein is green. The dotted line in the micrograph shows the region: Shh antibody reveals Shh. The part that will become the brain (head fold) is followed by the prechordal plate. Shh (in green) that is expressed in the prechordal plate induces midline structure formation.

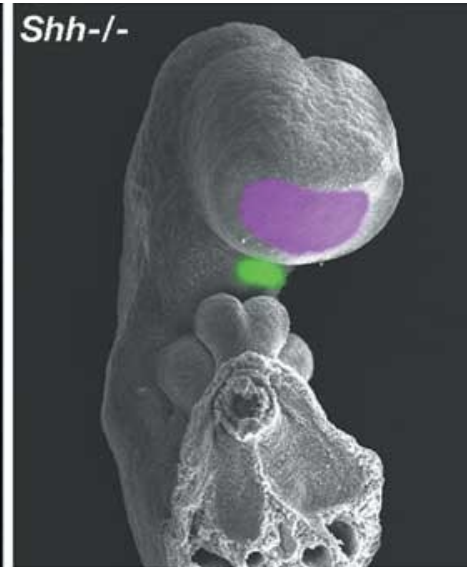
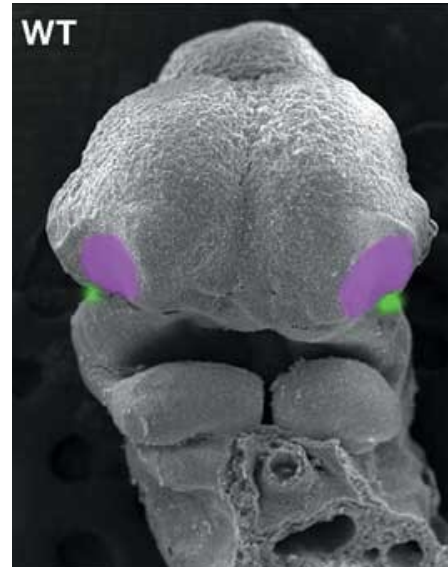

Model mice with Holoprosencephaly due to a Sonic Hedgehog (Shh) deficiency.

An SEM micrograph of ten-day old mouse embryos (front view of face). The mouse deficient in Shh gene (right) has no midline structure and only one region (eye position shown in green). Note, too, the lack of nostril separation due to no midline structure. The normal embryo (left), by contrast, has both the eyes and nostrils separated to between the two hemispheres.

Hedgehog (Hh) dráha je vázána na primární cilie

- Abnormální Hh/Wnt a s nimi spojená onemocnění jsou způsobena defekty ve tvorbě primárních cilií (infertilita, polydaktylie, polycystické ledviny, degenerace retiny).
- Hh je přímo vázán na primární cílie.

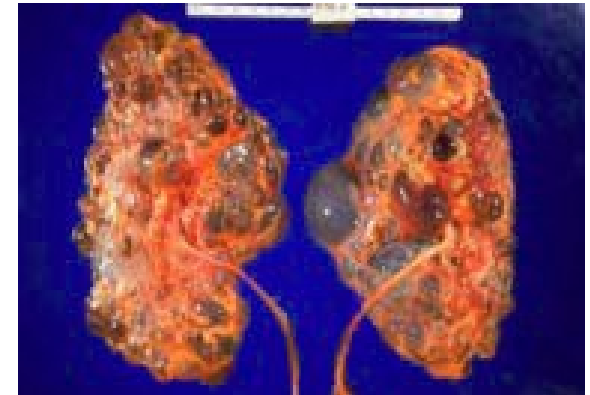
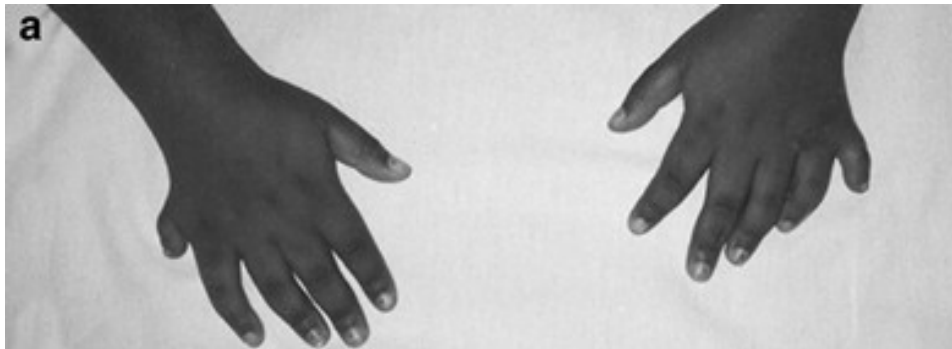

Primary cilia vs. motile (secondary) cilia

PRIMÁRNÍ

- struktura 9+0
- nepohyblivé
- téměř všechny buňky (www.primary-cilium.co.uk)
- solitérní

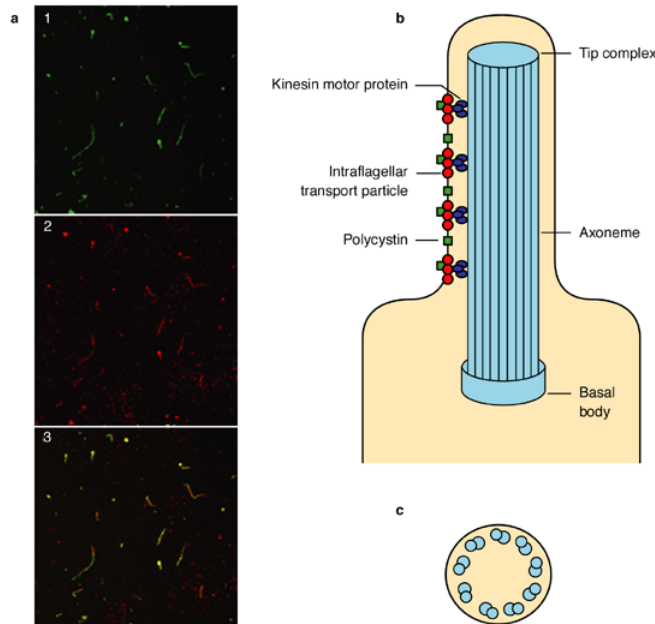

The primary cilium

Expert Reviews in Molecular Medicine © 2006 Cambridge University Press

SEKUNDÁRNÍ

- struktura 9+2
- pohyblivé
- epitelu tracheje, vejcovodů, ependym...

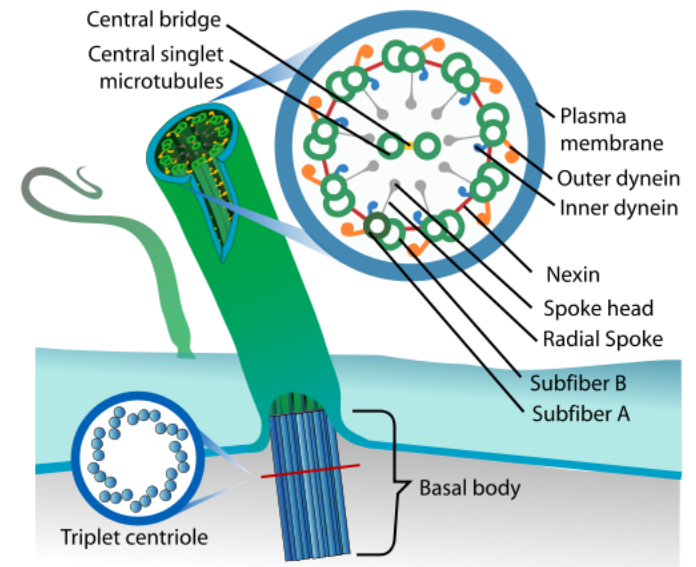

Primární cilie a Hh signalizace

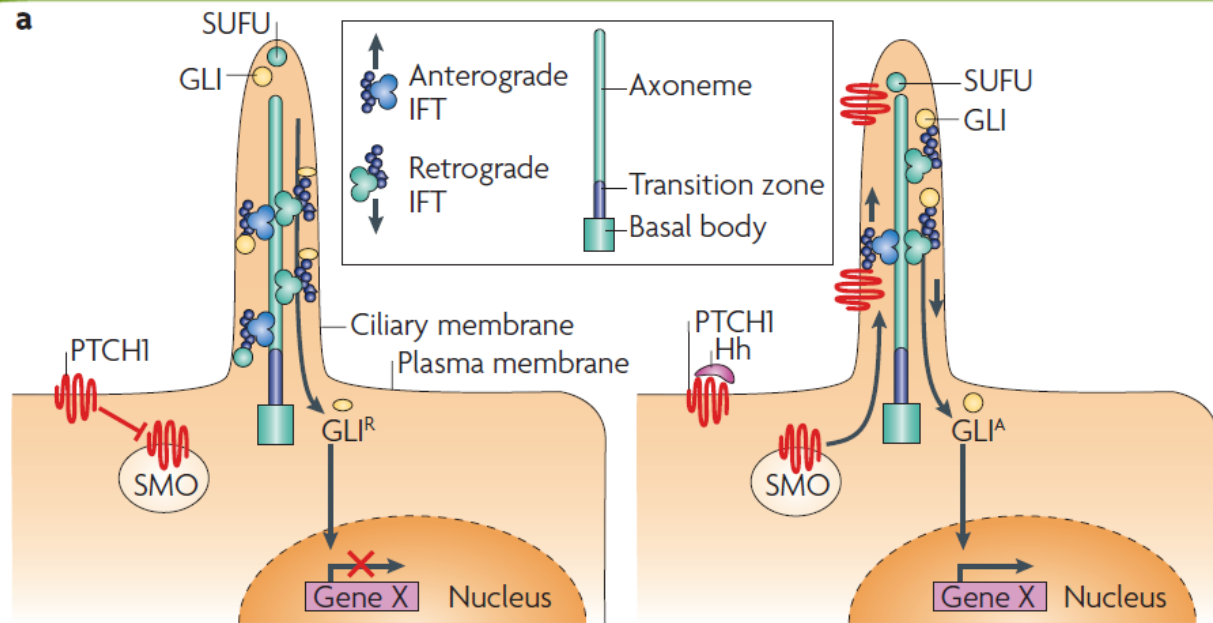

- Je spojen s primárními ciliemi
- Ligand se naváže na patch (Ptc) protein, což způsobí zrušení inhibičního efektu Ptc na protein smoothened (Smo), který transdukuje signál přes glioma transkripční faktory (Gli) do jádra, kde řídí expresi Hh genů. (Gli1, Gli2 a Gli3A jsou aktivátory a Gli3R je represor). Hlavním represorem je SuFu.
- IFT hraje klíčovou úlohu ve funkci regulace Hh signální dráhy (spojuje Smo a Gli)
- Mutace Kif3A a Kif3B mají podobné fenotypy v důsledku ztráty cilie.

Primární cilie a Hh signalizace – změny Gli

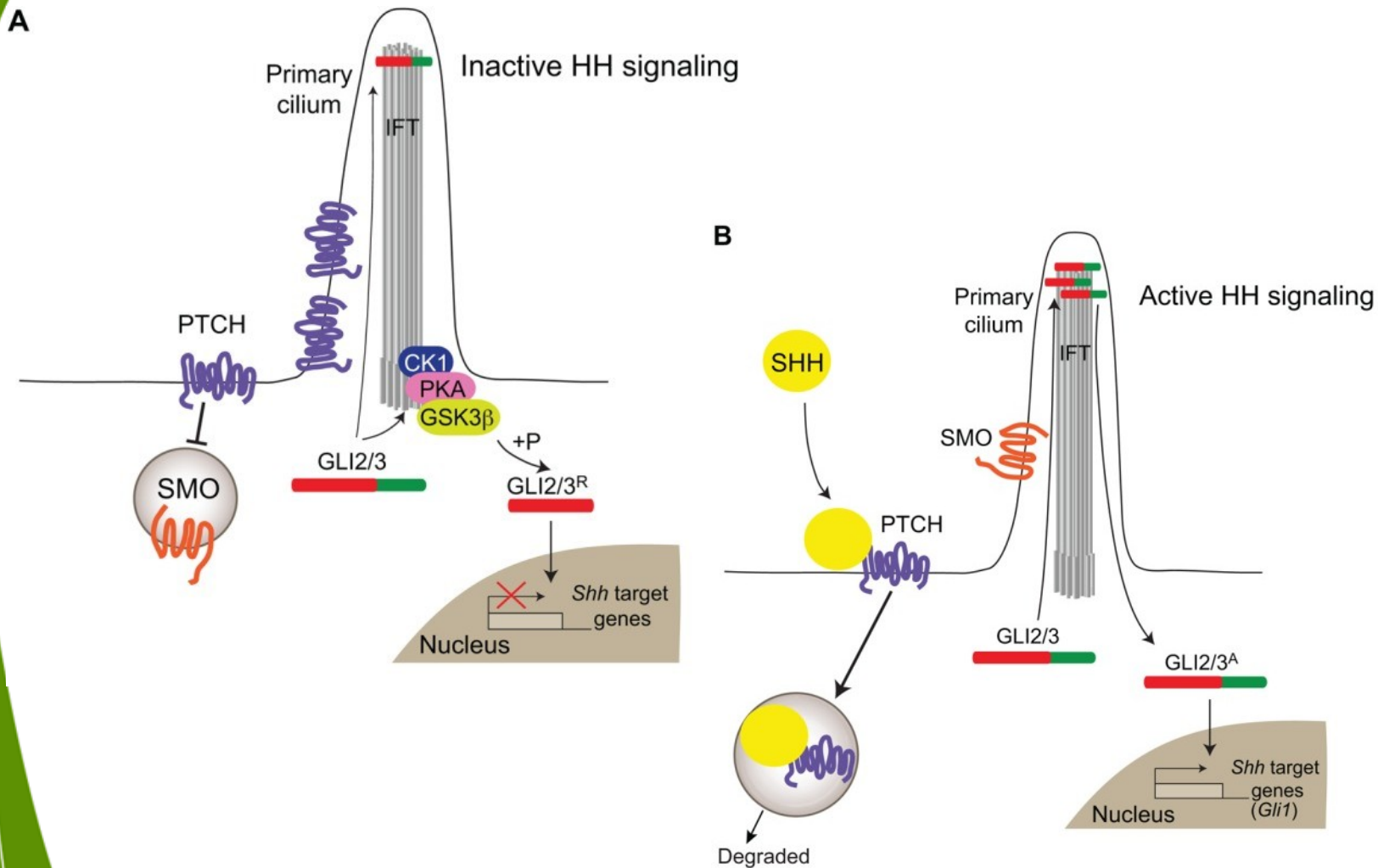

Fyziologie buň. systému

Hh signalizace reguluje „klidové“ kmenové buňky: v mozku

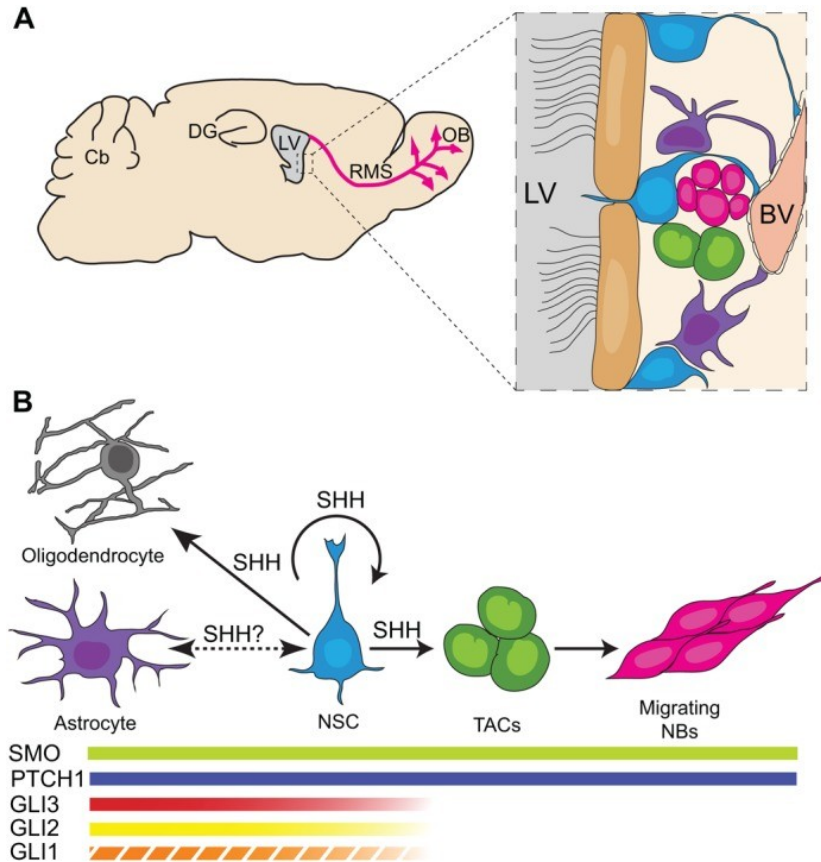

Neural stem cells in the mouse forebrain SVZ, like other adult stem cells, produce lineage-restricted progenitors and respond to SHH. (A) In the subventricular zone (SVZ) lining the lateral ventricles (LVs), neural stem cells (NSCs; blue) self-renew or divide asymmetrically to generate transit-amplifying cells (TACs, green), progenitors that proliferate and give rise to proliferating neuroblasts (NBs, magenta) that migrate away from the SVZ via the rostral migratory stream (RMS) to the olfactory bulb (OB). The end feet of NSCs and astrocytes (purple) often contact blood vessels (BVs), which are an essential component of the neurogenic niche. Multiciliated ependymal cells (brown) form the immediate boundary between the cerebrospinal fluid-filled ventricle and the SVZ. Cb, cerebellum; DG, dentate gyrus. (B) Mature astrocytes and NSCs share many molecular and morphological characteristics, and both cell types respond to sonic hedgehog (SHH) signaling. Whether one cell type can be transformed into the other (dashed double-headed arrow), as appears to occur during injury and what role HH signaling may play in this process remain to be determined. NSCs also produce a small number of oligodendrocytes (gray), which is augmented by SHH signaling. Smoothed (SMO) and patched 1 (PTCH1) are thought to be expressed at all the stages of NSC lineage progression. Activation of the canonical HH signaling pathway, however, occurs only at the NSC stage, where it is important for maintaining the undifferentiated and proliferative state of the NSCs (circular arrow). Expression of the glioma-associated oncogene proteins (GLIs) ends as the lineage progresses from NSCs to TACs. In addition, whereas GLI2 and GLI3 are expressed in mature astrocytes and NSCs throughout the SVZ and the rest of the brain, GLI1 is present in only a subset of NSCs and astrocytes (hatched orange line), possibly in regions where HH signaling is the highest.

- Důsledek deregulace Shh v mozku – meduloblastom, glioblastom ...

Fyziologie buň. systému

Hh signalizace reguluje „klidové“ kmenové buňky nebo v kůži

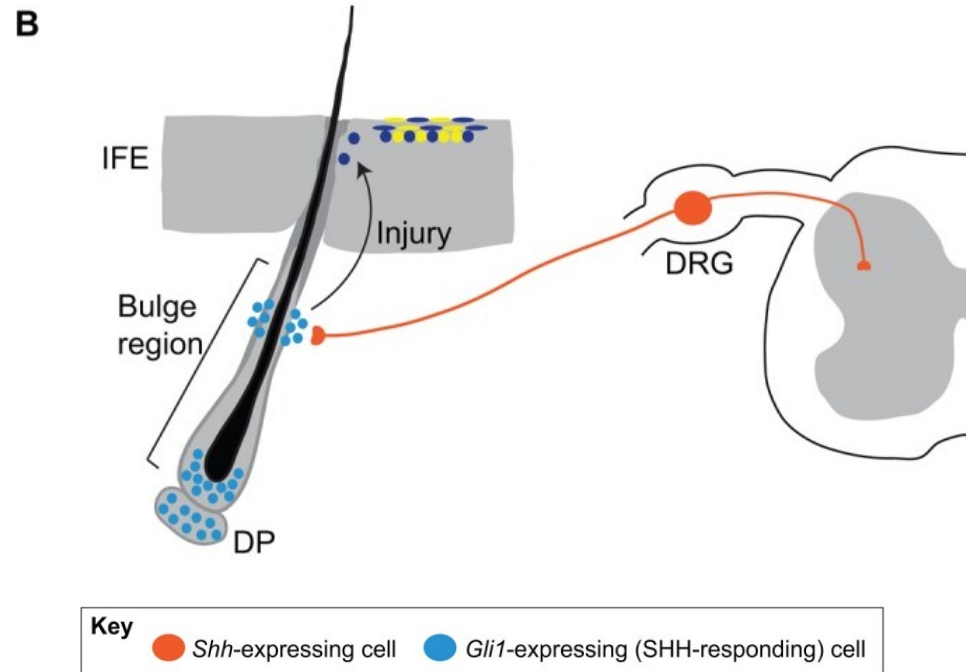

- Důsledek deregulace *Shh* v kůži – bazocelulární karcinom (BCC)

Primární cilie a Hh signalizace: důkaz

Basal cell carcinoma – způsobena aktivací Smoothened

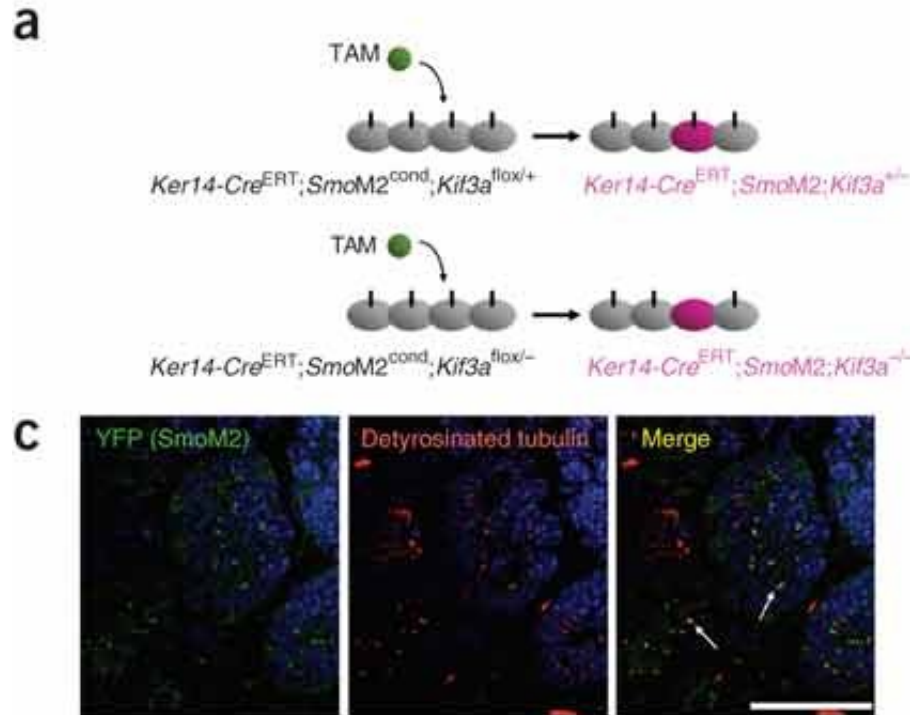

Ker14-Cre: drives expression to the epidermis

SmoM2 (cond): constitutively active Smoothened (activated by Cre)

Kif3a Flox: following Cre leads to Kif3a deletion and primary cilia loss

Primární cilie a Hh signalizace: důkaz

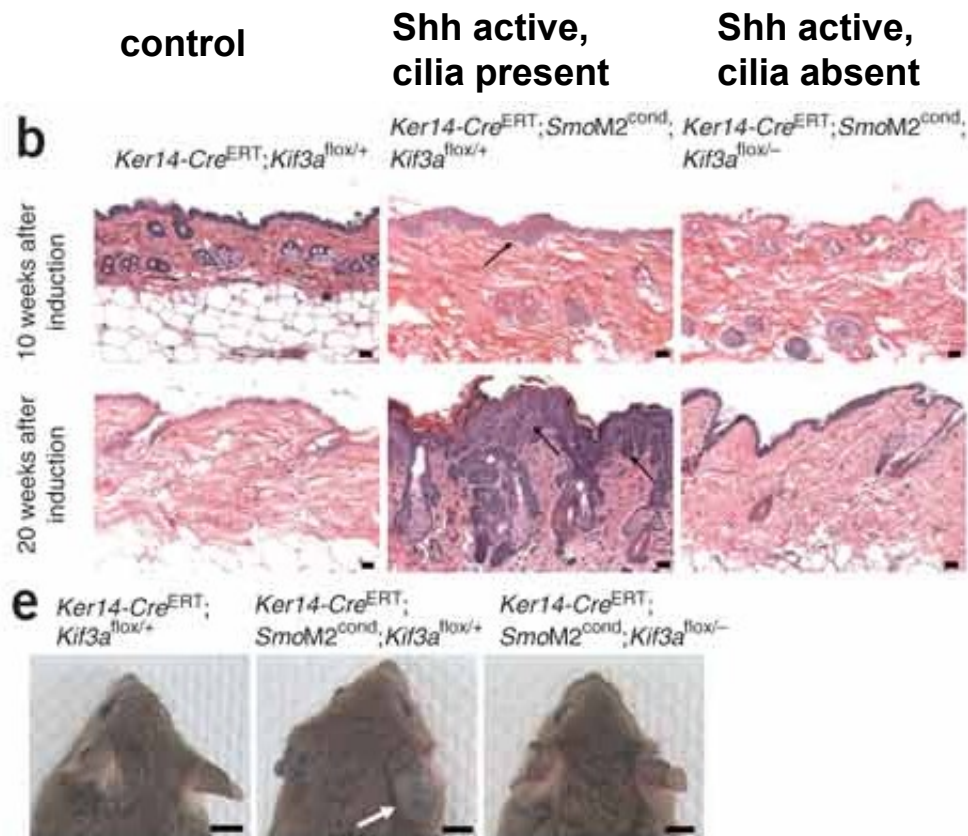

Ker14-Cre: drives expression to the epidermis

SmoM2 (cond): constitutively active Smoothened (activated by Cre)

Kif3a Flox: following Cre leads to Kif3a deletion and primary cilia loss

Klíčové molekulární komponenty vývoje

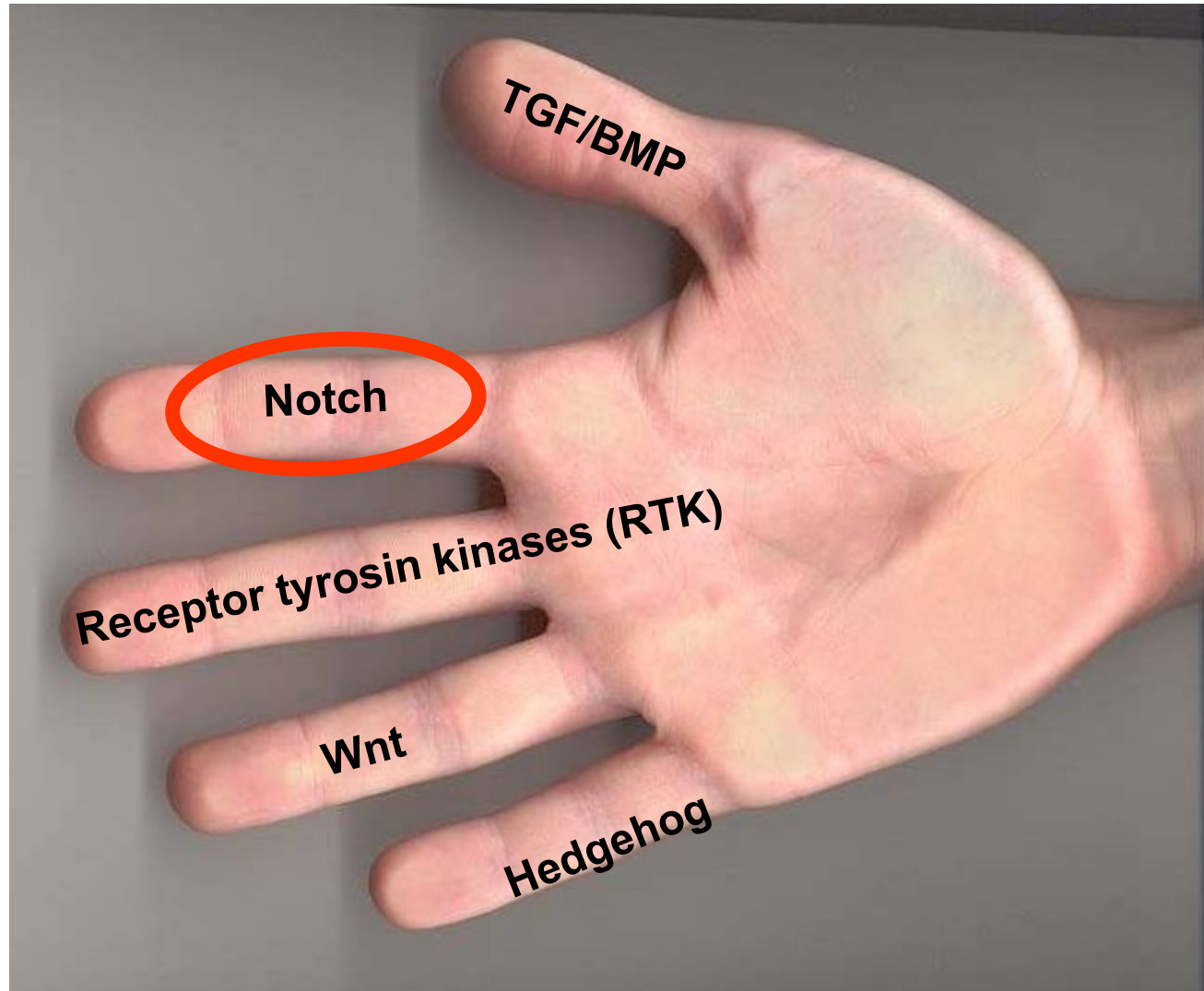

Notch

- Notch=zářez – podle prvního fenotypu octomilky se zářezy na křídlech (T.H. Morgan, 1919)

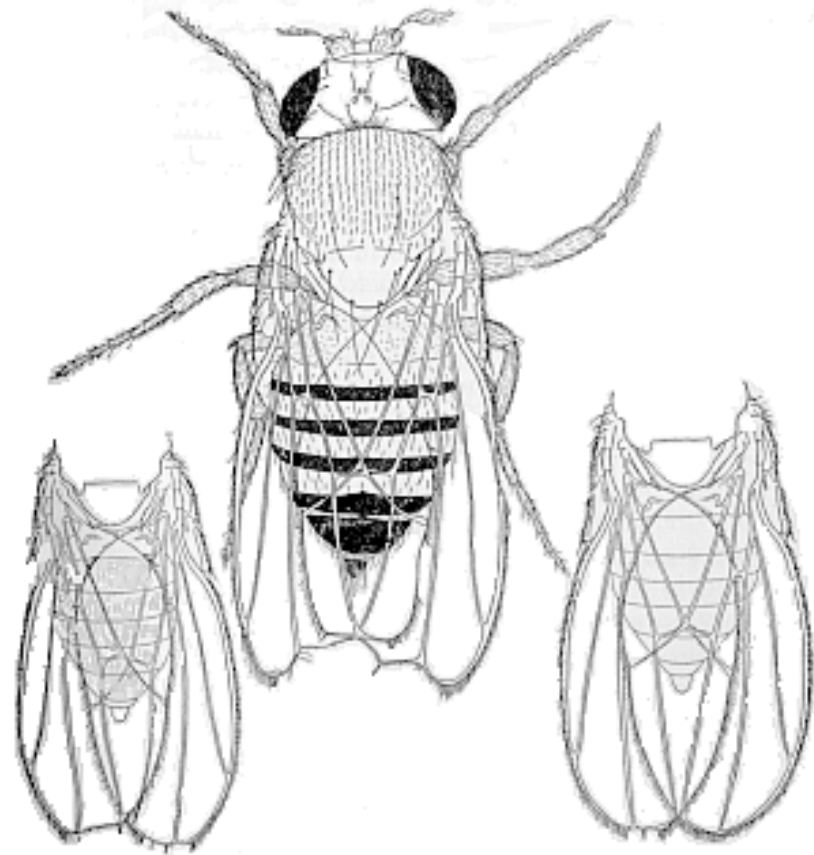

Notch

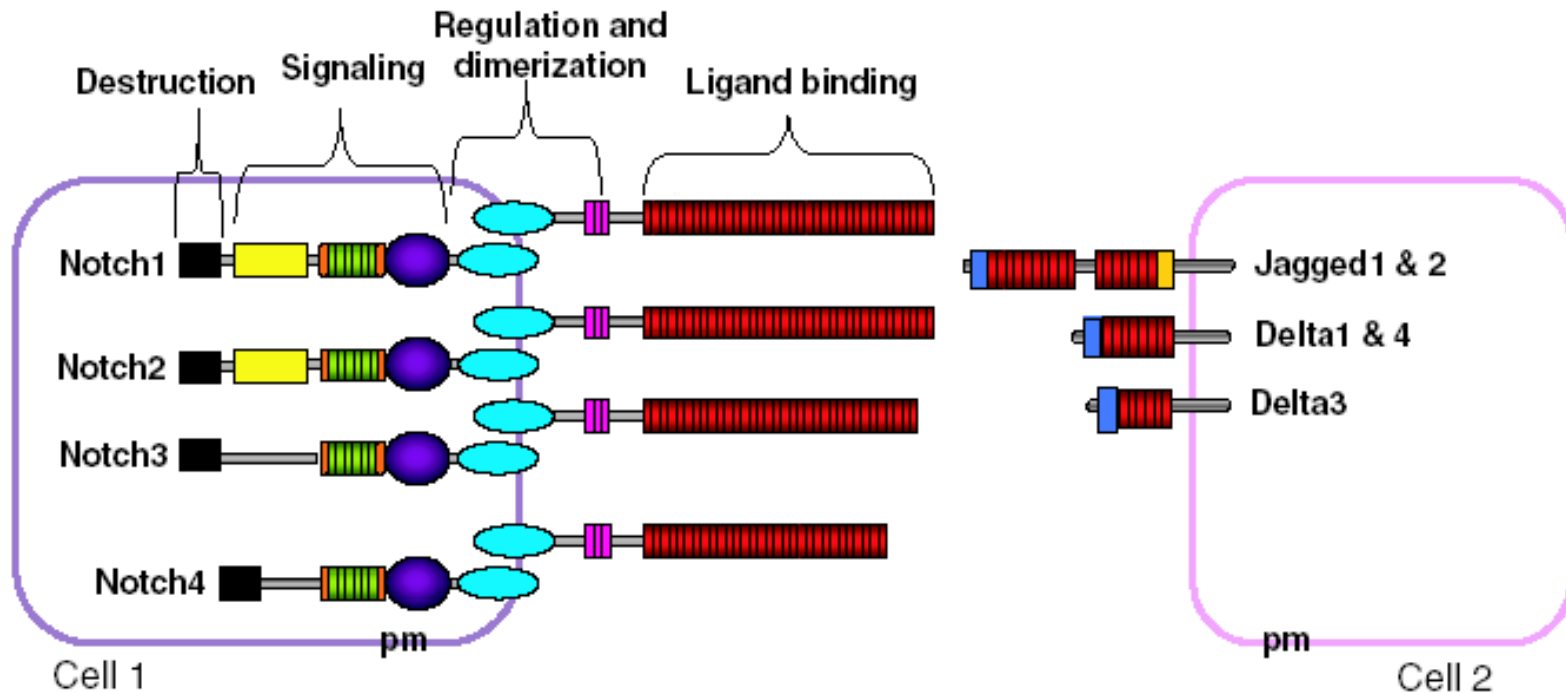

Transmembránové heterodimerické receptory Notch 1-4

Notch ligandy Jagged a Delta – jsou vázány na buněčný povrch

Notch dráha - overview

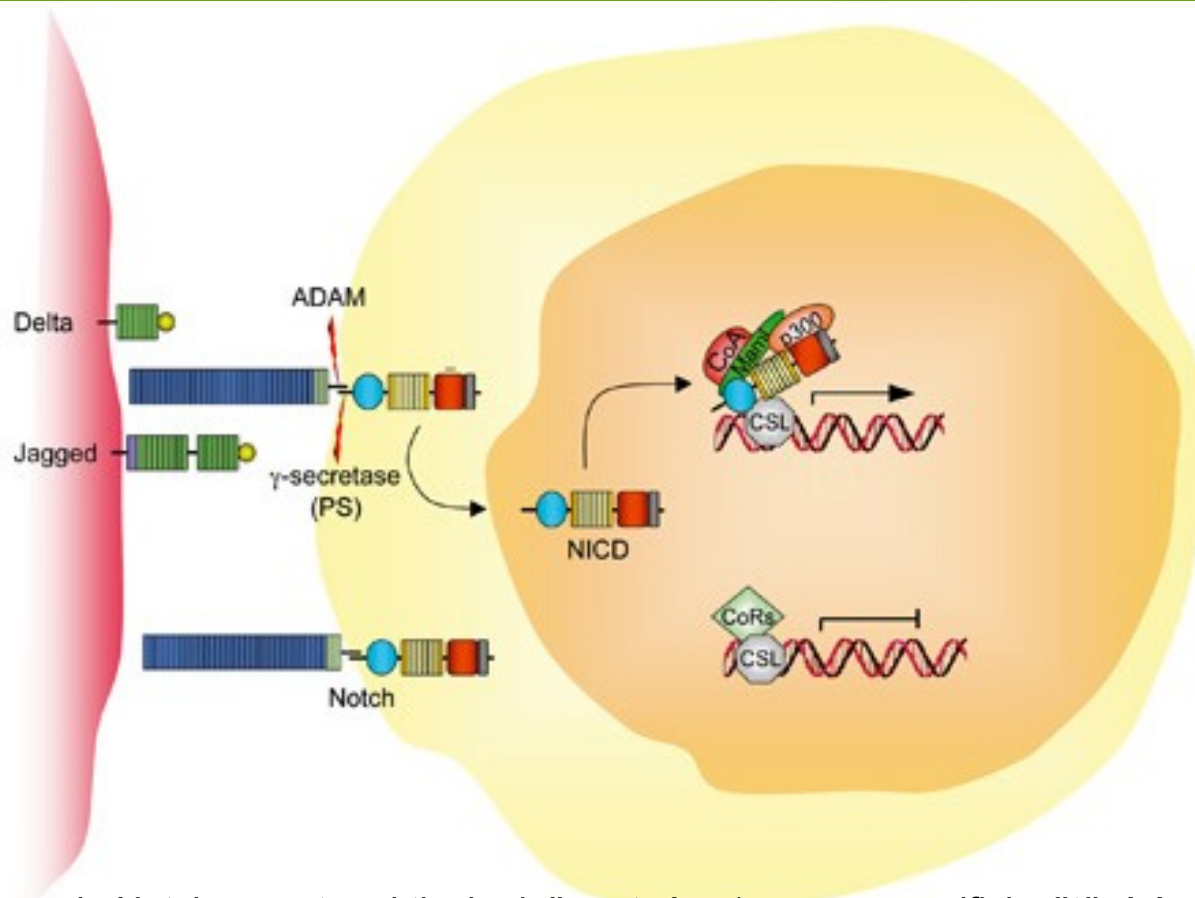

- Vazba ligandu Notch receptor aktivuje dvě proteázy (enzymy specificky štěpící protein)
- Proteázy jsou z rodiny ADAM a gamma-sekretáz
- Štěpení Notch těmito proteázami uvolňuje tzv. NICD (Notch intracellular domain), který se uvolňuje a do cytoplazmy a následně přesouvá do jádra
- NICD přímo interaguje s transkripčními faktory CBF1/Mastermind a spouští transkripci

Notch dráha - biologie

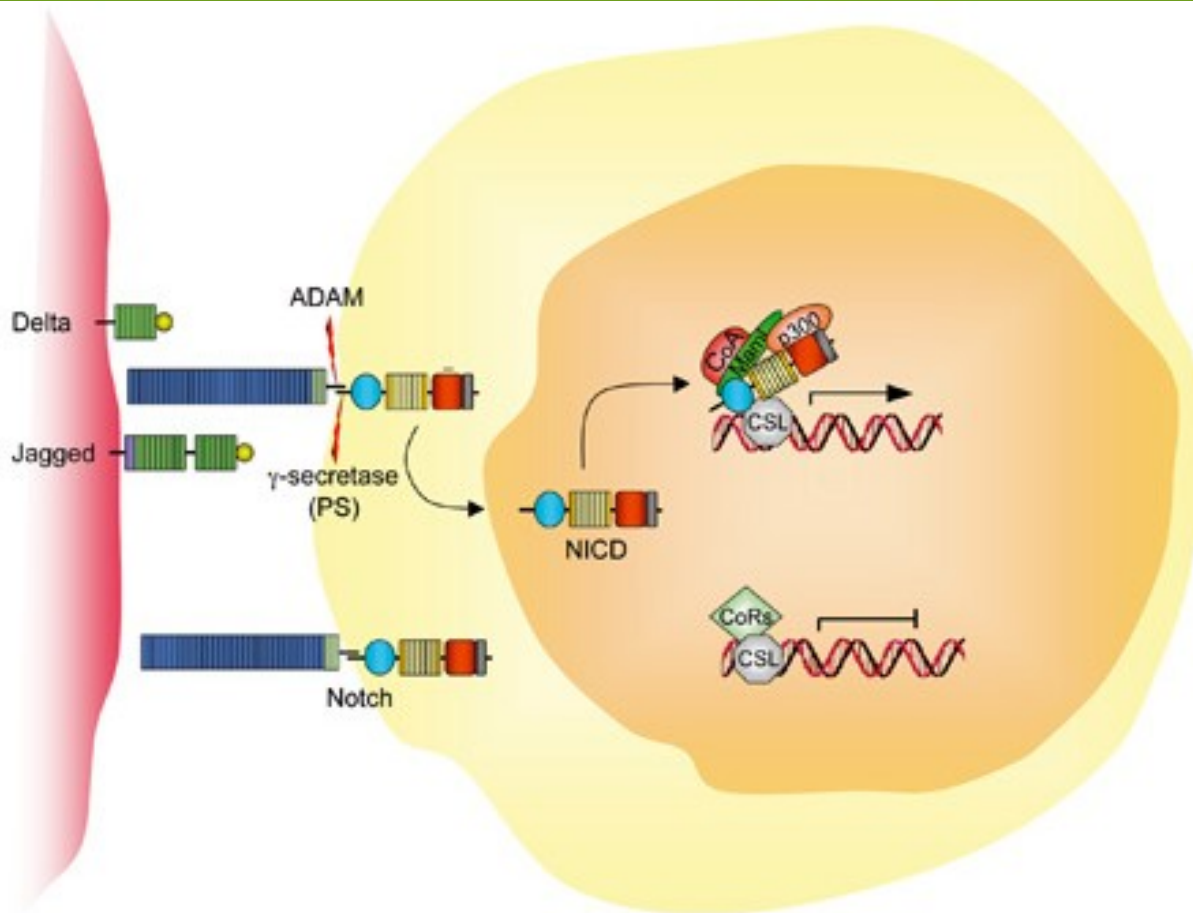

- Díky přímému působení má význam zejména při diferenciaci
- Typicky např. „Binary decisions“ a laterální inhibici
- Role v nikách kmenových buněk nebo při angiogenezi

Nika zárodečných kmenových buněk (*Caenorhabditis elegans*)

► <https://www.stembook.org/node/497>

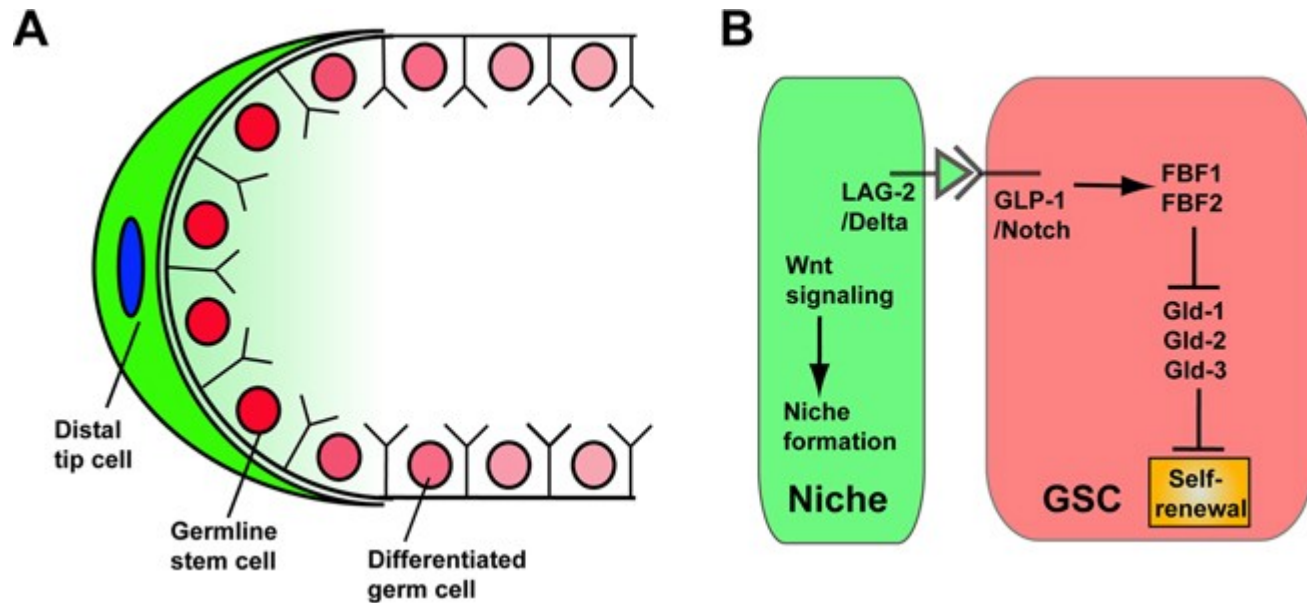

Laterální inhibice – proces, který zajistí, že dvě sousedící buňky nebudou mít stejnou buněčnou identitu (fate); díky signálním drahám (např. Notch), které díky přímému kontaktu zajistí odlišnost sousedících buněk

Nika zárodečných kmenových buněk (Drosophila melanogaster)

➔ <https://www.stembook.org/node/497>

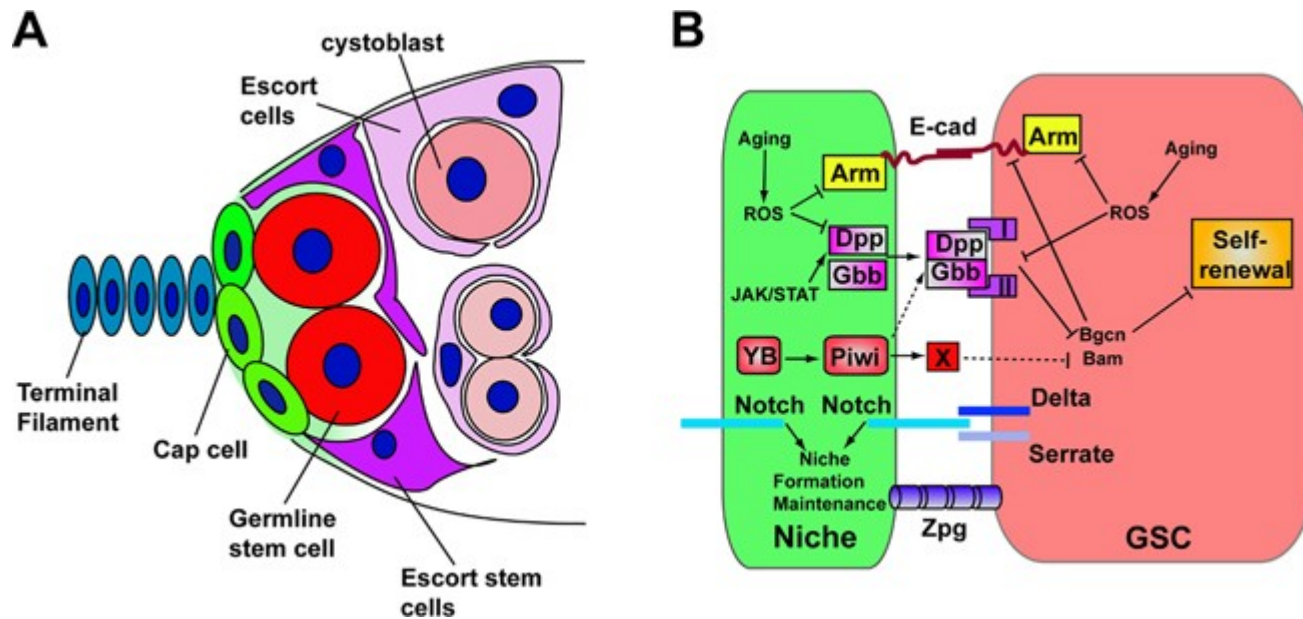

Nika kmenových buněk ve střevě

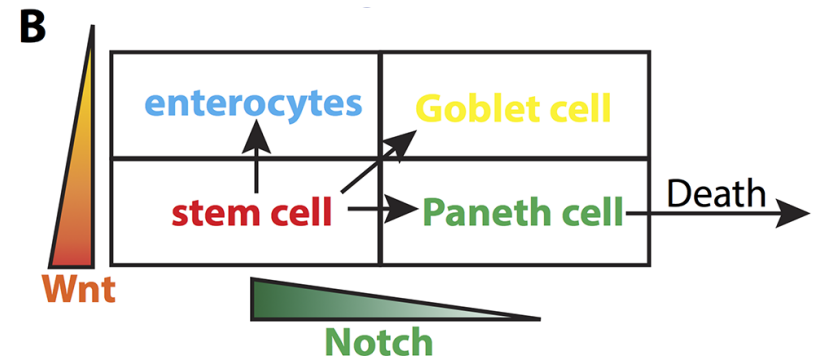
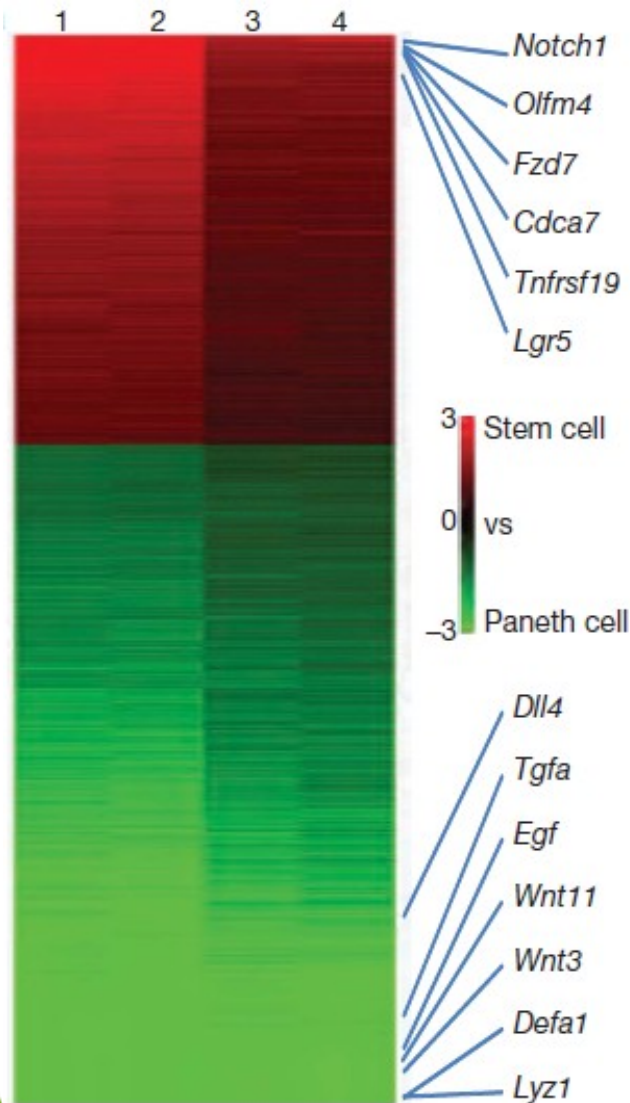

- Pohárková buňka (Goblet cell) – vylučuje mucin a produkuje hlen
- Enterocyt – diferencovaná buňka epitelu střeva

Notch dráha – role v angiogenezi

- Viz další přednáška

Klíčové molekulární komponenty vývoje

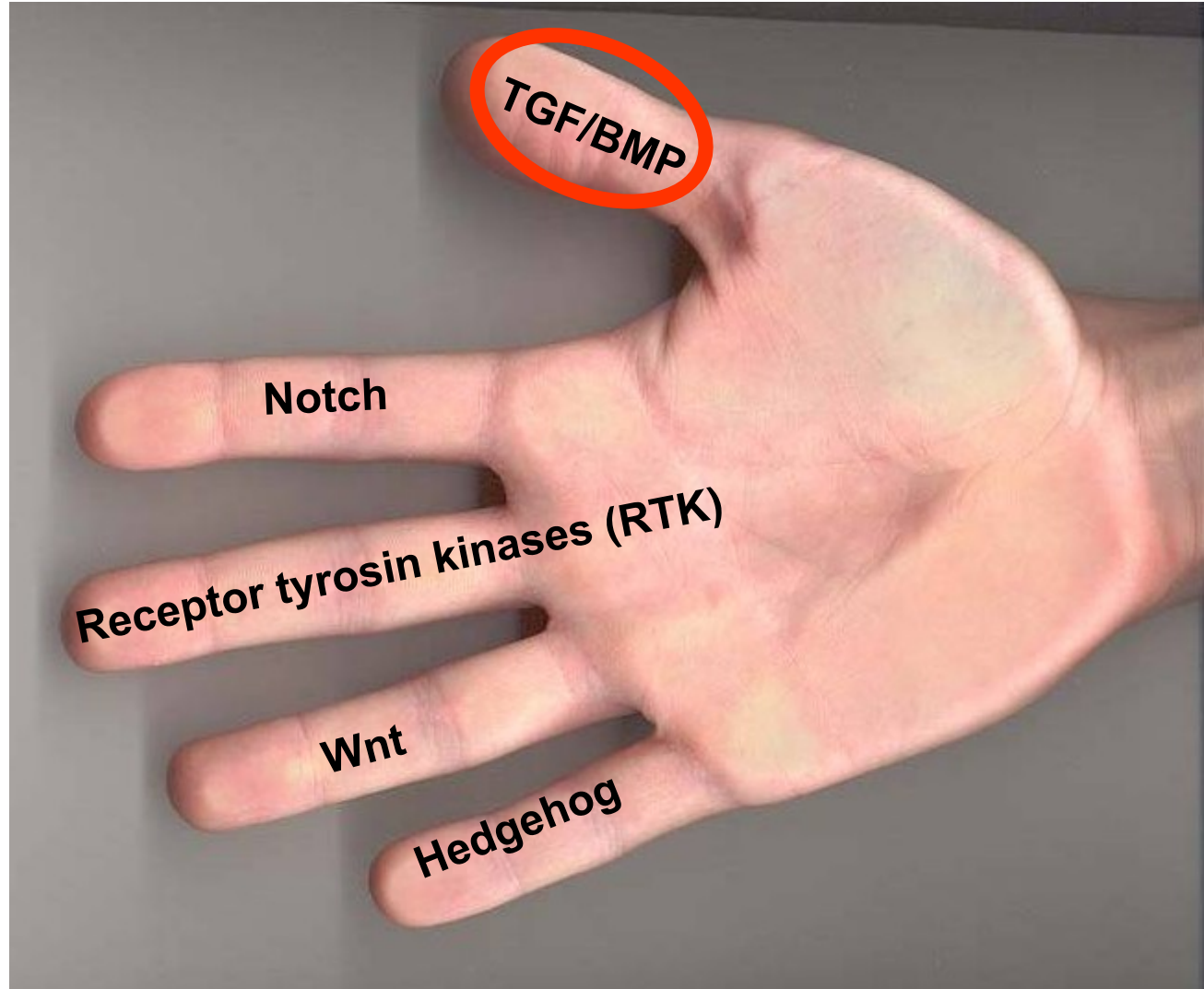

TGF/BMP

- TGF – transforming growth factor (transformující růstový faktor)
- BMP – bone morphogenetic protein (kostní morfogenetický protein)
- patří do TGF β nadrodiny

TGF beta nadrodina:

TGF β nadrodina má následující podrodiny:

1. TGF β 1-3
2. BMPs – 20 různých ligandů
3. GDF (growth differentiation factor): 9 ligandů
4. activin/inhibin/nodal

Společným znakem je signalizace přes:

- konzervativní rodinu Ser/Thr kinázových receptorů – jsou dvou typů a po vazbě ligandu dimerizují
- cytoplazmatická signalizace přes tzv. SMAD proteiny

Signální dráha BMP

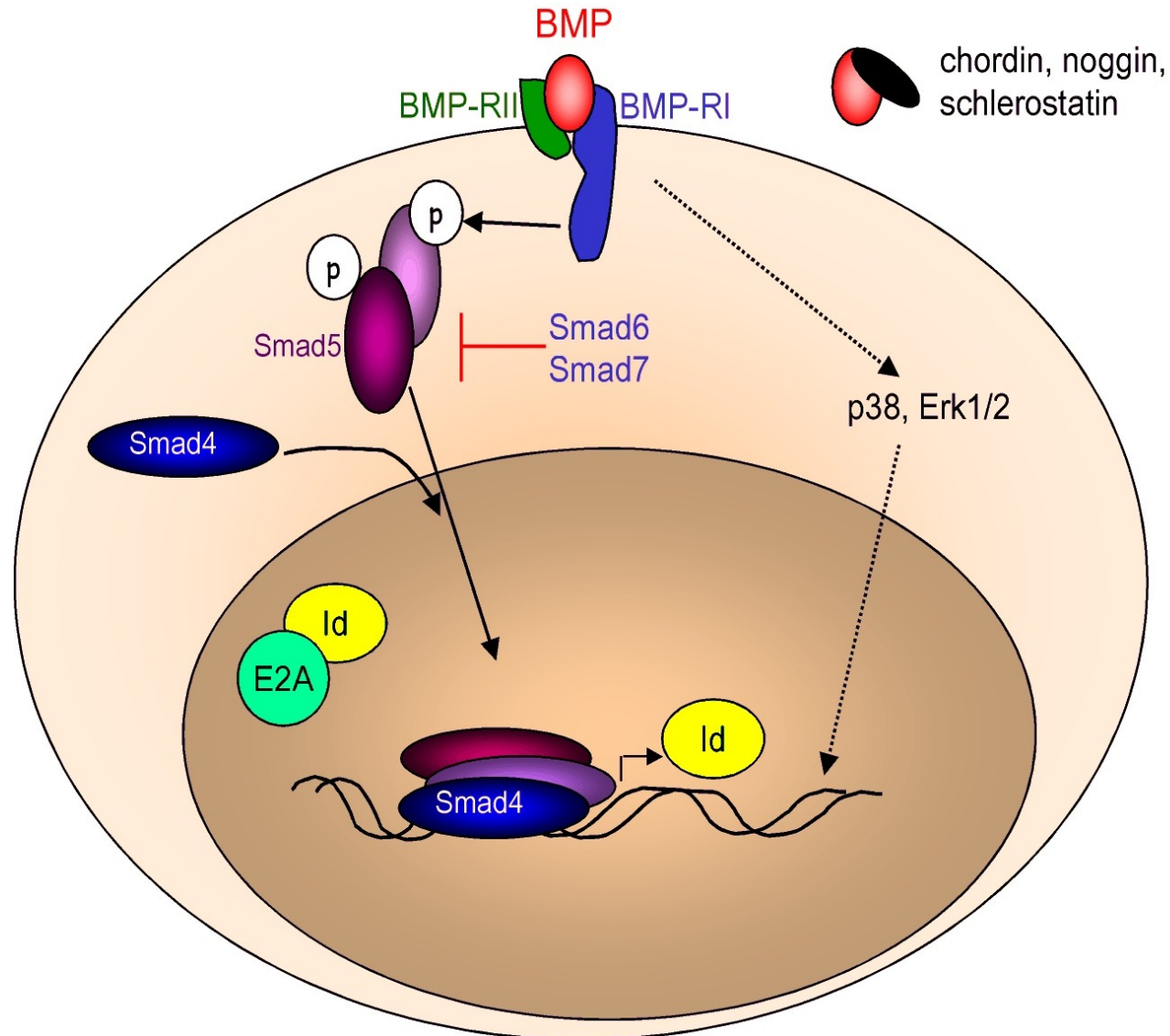

Inhibitory BMP faktorů

jsou klíčové pro fyziologické funkce BMP

- noggin
- chordin (Chd)
- sklerostin

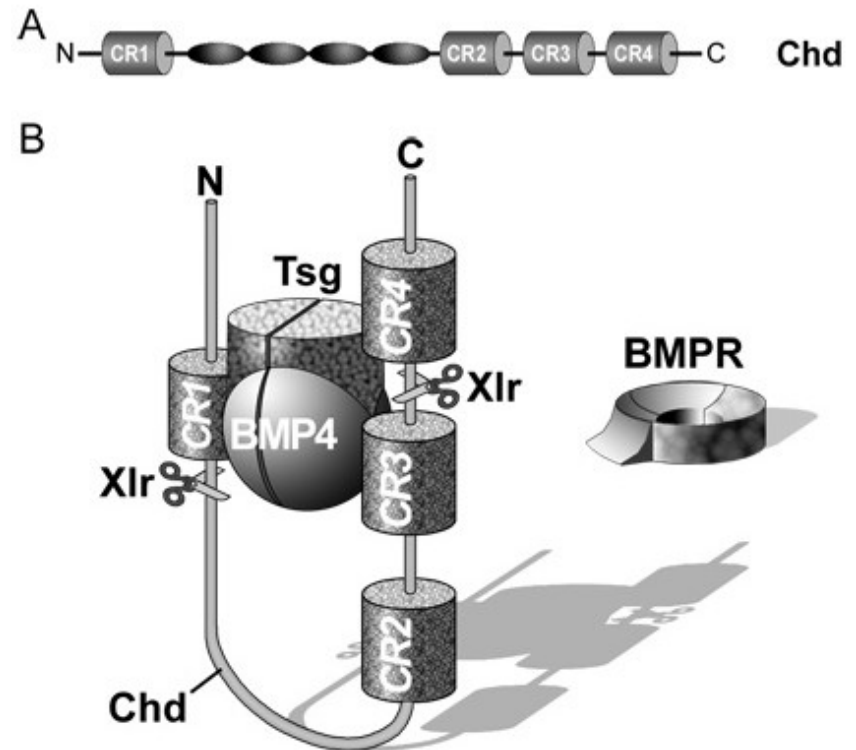

Přímá fyzická interakce mezi chordinem a BMP je podstatou inhibičního působení chordinu

Klíčová role BMP inhibitorů produkovaných notochordem při indukci nervové ploténky

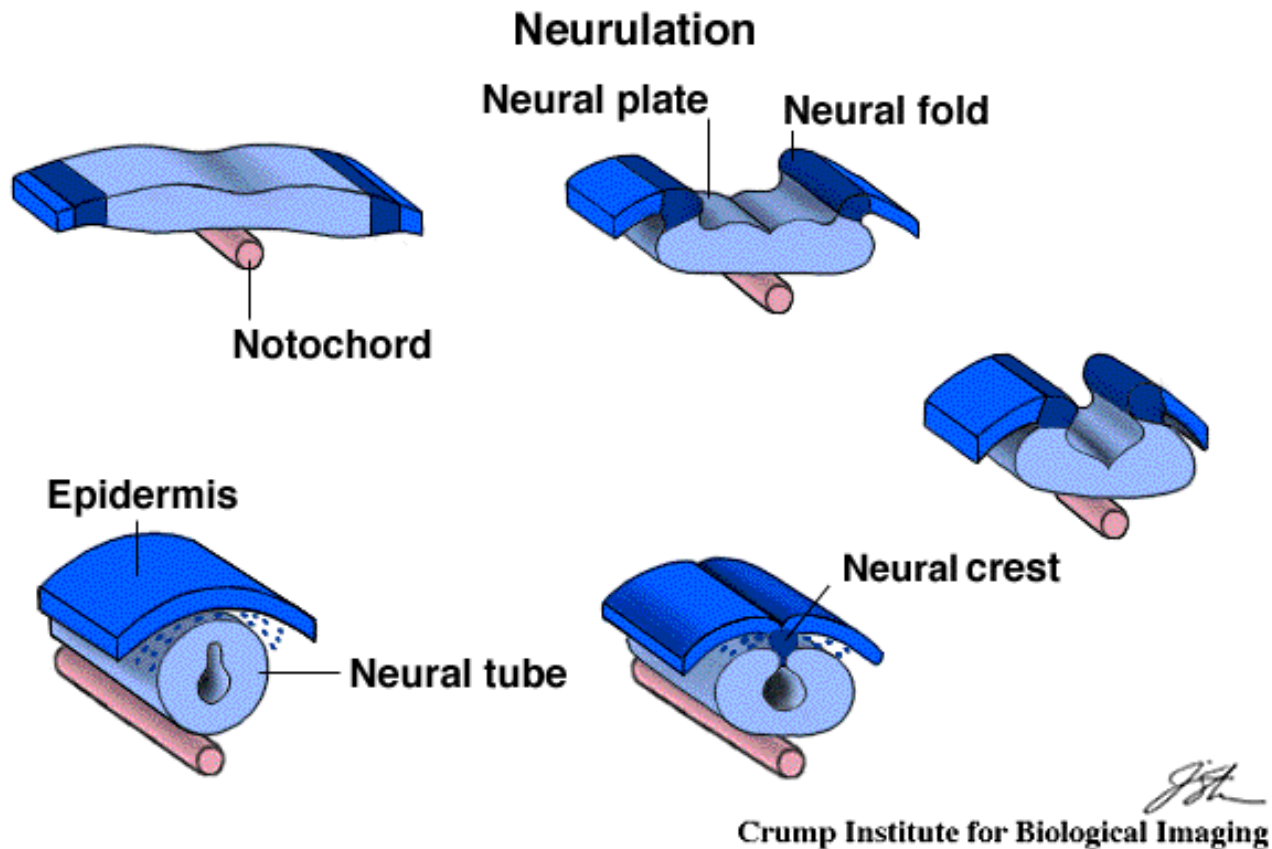

notochord (= chorda) produkuje faktory, které specifikují ektoderm a vedou ke tvorbě nervové ploténky (neural plate). Jde zejména o následující faktory: **noggin**, **chordin** a **folliculin** (inhibitory BMP a aktivinu).

BMP signalizace přímo antagonizuje Wnt ve střevní kryptě

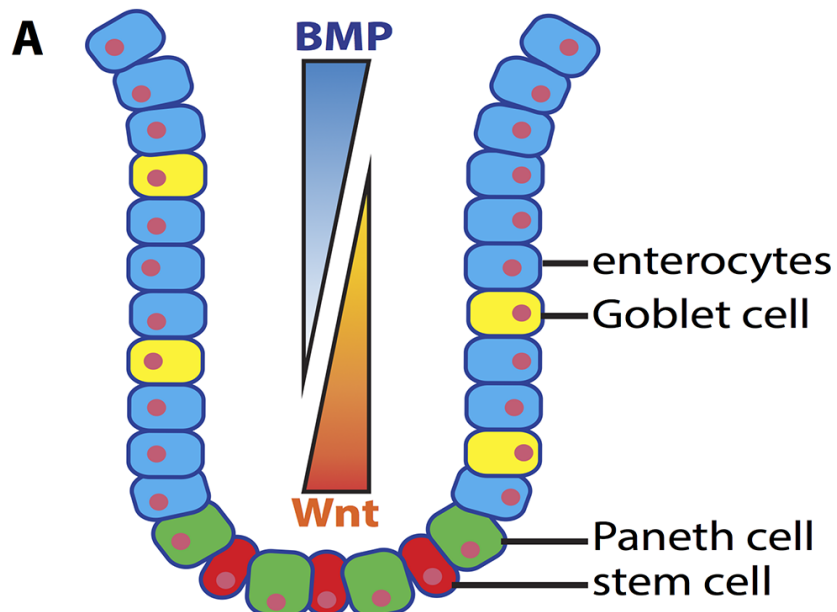

- Noggin (inhibitor BMP) je spolu s Wnt, R-spondinem a EGF základní složkou média pro kultivaci organoidů

Další zajímavé proteiny z BMP rodiny

Myostatin (GDF8) – regulátor diference svalů

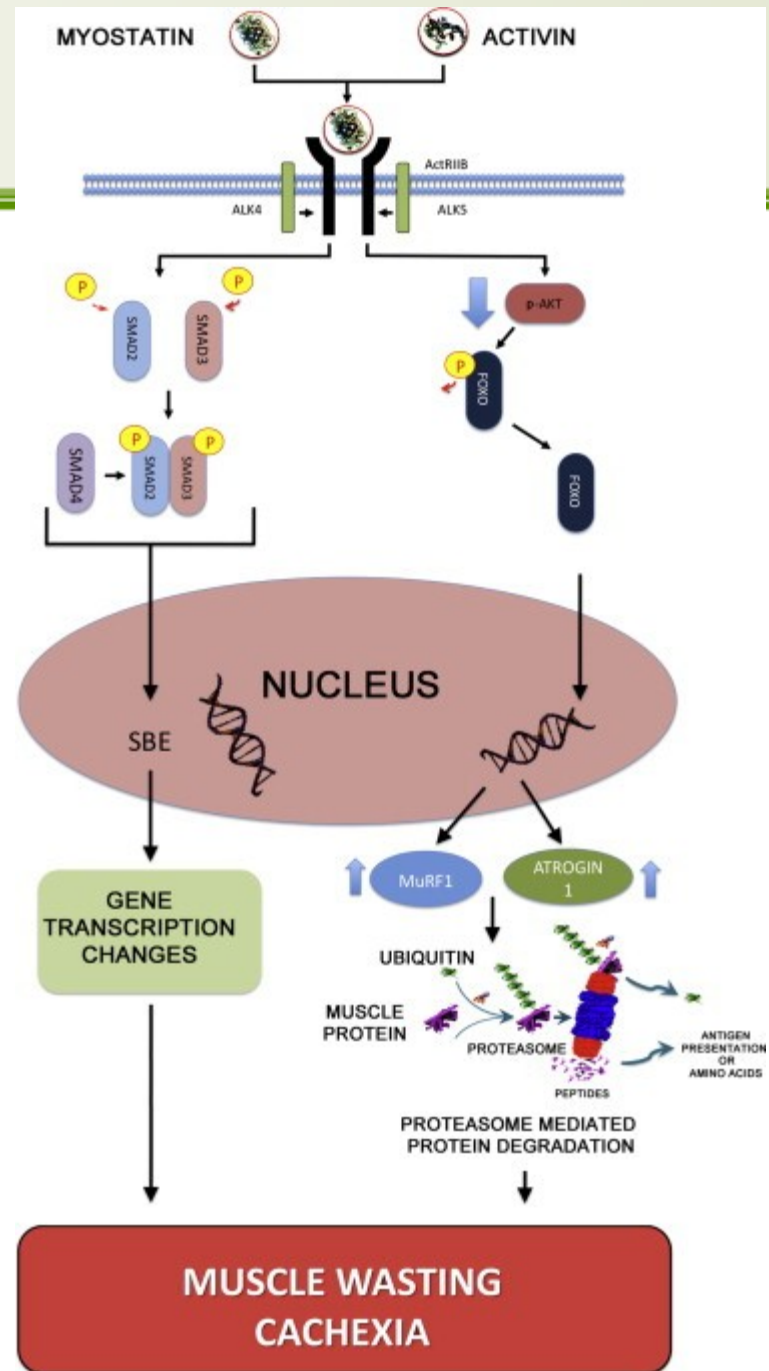

GDF8 (myostatin) – příklad tzv. master regulátoru konkrétní tkáně

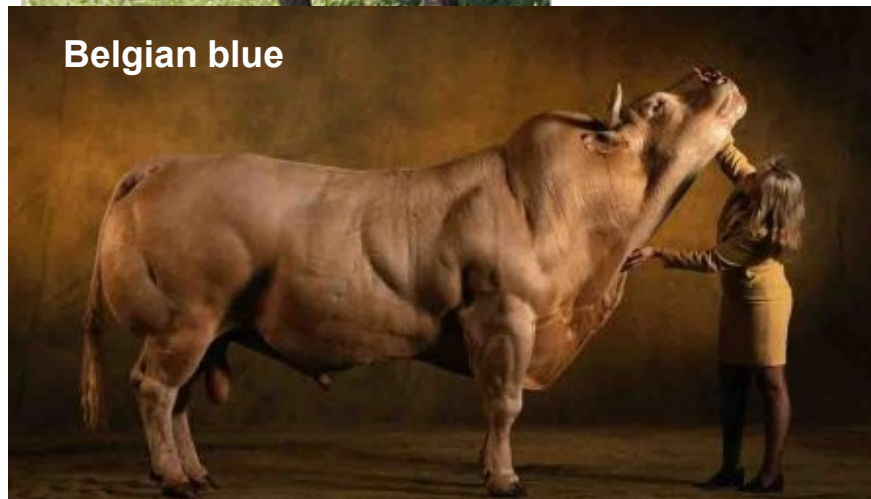

ASK THE TRAINER #8 – MYOSTATIN INHIBITORS

POSTED ON FEBRUARY 17, 2015 BY CHAD SHAW



QUESTION:

What do you think of myostatin inhibitors? I am asking because my workout partner bought one of these products. After doing my own research I am on the fence. I am aware that Myostatin is something the human body produces to slow and regulate muscle growth. I don't know if stopping something your body does naturally is a good idea?

Glen

ANSWER:

Hi, Glen. Myostatin, which is also known as "Growth Differentiation Factor-8" (GDF-8), is a protein embedded in the MSTN gene in humans. It's produced mainly in skeletal muscle cells and binds to receptors in muscle tissue.

TOP RATED PRODUCTS



Kre Alkalyln Hardcore



\$26.99



Vita Drive



\$20.99



Karbolyln Hydrate



\$44.99 - \$48.99



Training Ground Isolate



\$31.99 - \$42.99



Training Ground EAA



\$24.99



Training Ground Protein 6



\$35.99

A study in mice reported that [SRK-015 helped improve muscle capacity and strength](#), and increased lean body mass, particularly in the fast-twitch muscle fibers that are affected in SMA.

Another study found that SRK-015 effectively [increased muscle mass and function](#) in a mouse model of SMA, and also improved the animals' bone structure.

SRK-015 in clinical trials

A placebo-controlled and double-blind Phase 1 clinical trial tested ascending doses of SRK-015 in healthy volunteers. [Positive final results](#), announced in June 2019, showed that participants tolerated SRK-015 well across all doses up to 30 mg/kg, with no dose-limiting toxicities.

A [Phase 2 trial called TOPAZ \(NCT03921528\)](#) opened in May 2019 to evaluate the safety and efficacy of SRK-015 in people with SMA [type 2](#) and [type 3](#). The trial has enrolled 58 patients, ages 2 to 21, at centers in the U.S., Italy, the Netherlands, and Spain.

Patients are divided into three groups, and all are being treated for one year. Those in groups 1 and 2 are being given 20 mg/kg of SRK-015 by intravenous infusion once every four weeks; group 1 includes ambulatory [type 3](#) patients, and group 2 type 2s and 3s who are not able to walk. Those in group 3, all type 2 patients, are randomly receiving SRK-015 infusions of 20 mg/kg or 2 mg/kg once every four weeks for one year. Patients can also be using an approved SMN upregulator therapy. Its primary goals are measures of safety, and clinically meaningful changes in motor function or physical abilities based on the [revised Hammersmith scale](#) and the [expanded Hammersmith functional motor scale](#).

Preliminary trial data released in November 2019 showed a [dose-dependent increase of up to 100-fold in blood levels of latent or inactive myostatin](#). The analysis included 29 patients in total: 12 from group 1, eight from group 2, and nine from group 3. All had been given a single dose of SRK-015 and researchers evaluated them after four weeks. They reported no safety issues.

[Scholar Rock plans](#) to analyze interim safety and efficacy in a subset of patients after six months of treatment, and expects to announce findings late in 2020. Topline results for

nature

International weekly journal of science

[Home](#) | [News & Comment](#) | [Research](#) | [Careers & Jobs](#) | [Current Issue](#) | [Archive](#) | [Audio & Video](#) | [Feedback](#)

[Archive](#) > [Volume 523](#) > [Issue 7558](#) > [News](#) > [Article](#)

NATURE | NEWS



Super-muscly pigs created by small genetic tweak

Researchers hope the genetically engineered animals will speed past regulators.

David Cyranoski

30 June 2015



PDF



Rights & Permissions



Xu-jun Yin

These meaty pigs could become the first genetically engineered animals to be approved for human consumption.

Belgian Blue cattle are hulking animals that provide unusually large amounts of prized, lean cuts of beef, the result of decades of selective breeding. Now, a team of scientists from South Korea and China says that it has created the porcine equivalent using a much faster method

Klíčové molekulární komponenty vývoje

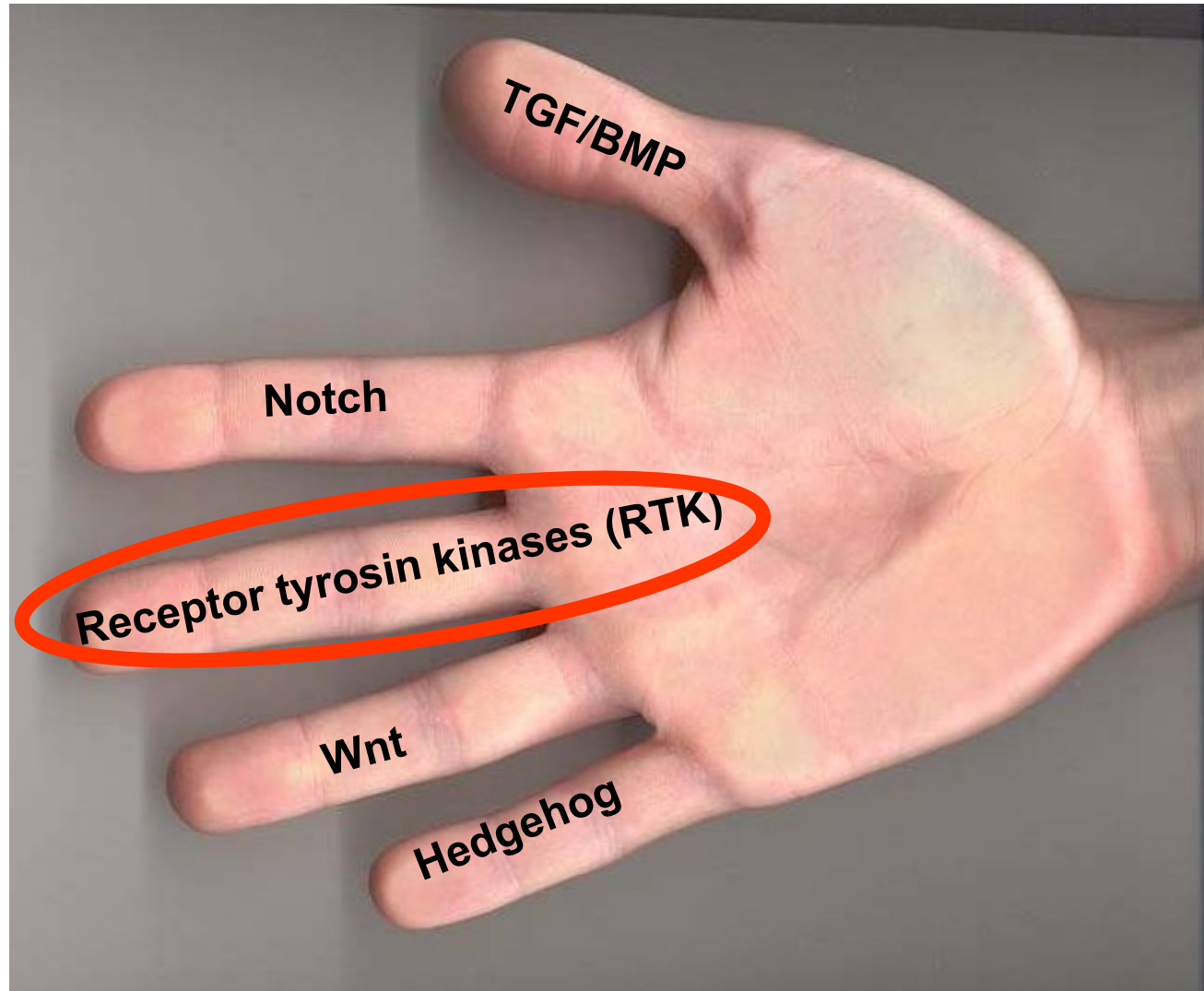

Receptorové tyrosin kinázy (RTK)

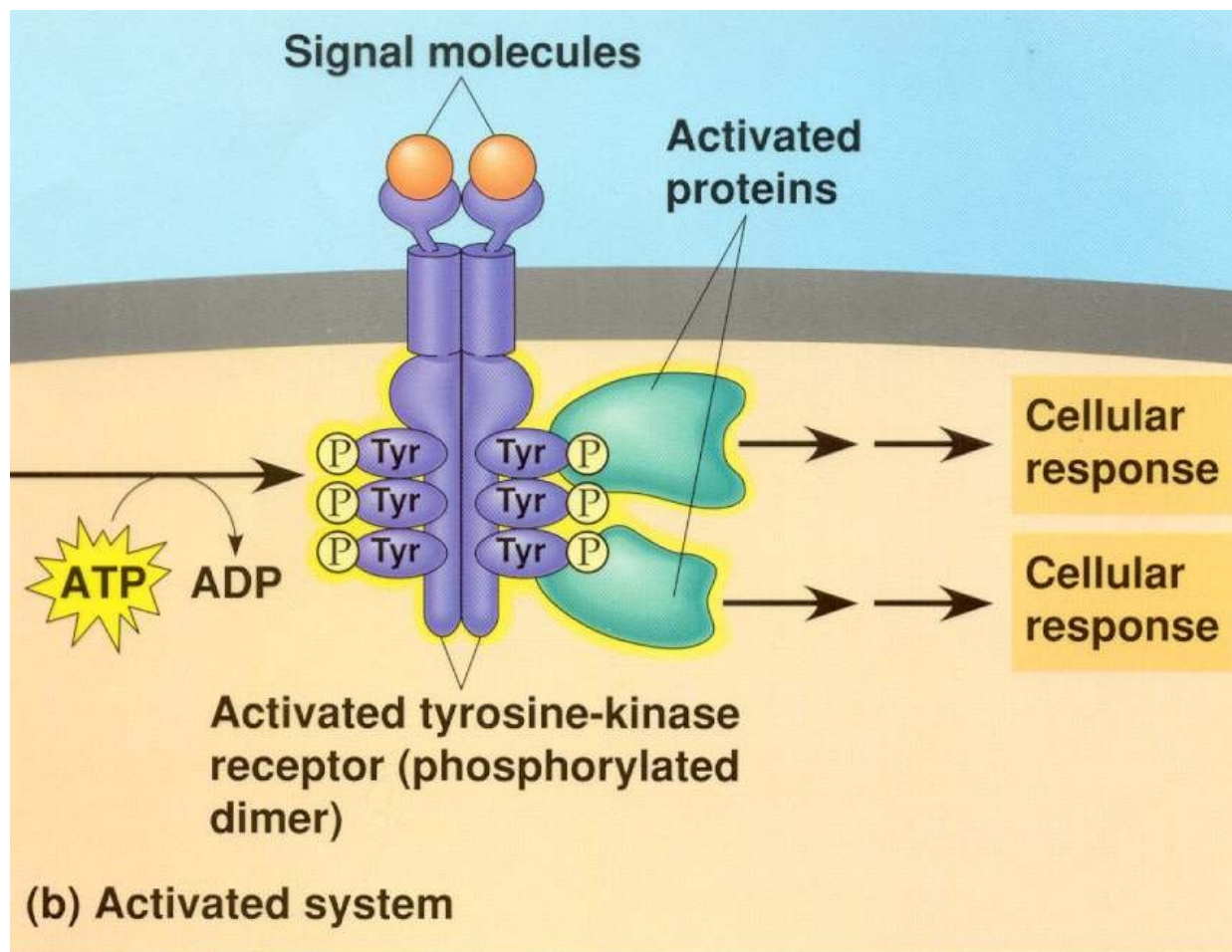

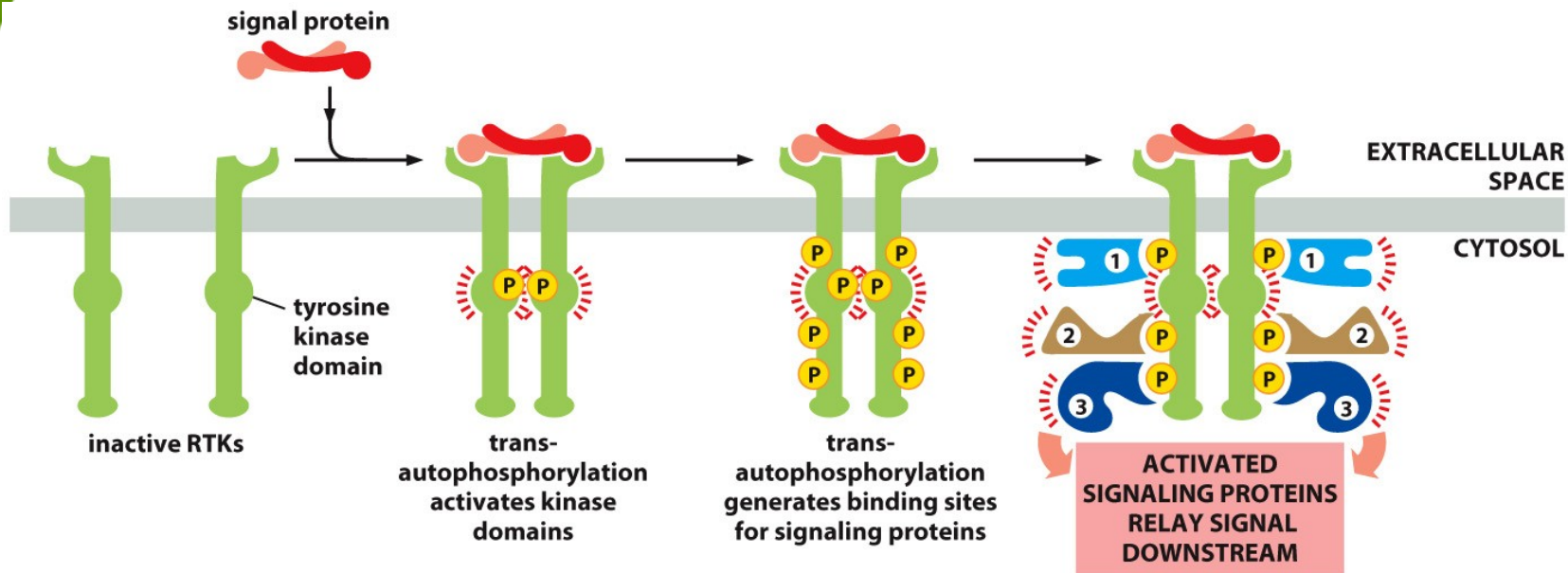

Figure 15-44 Molecular Biology of the Cell 6e (© Garland Science 2015)

1. ligand se specificky váže na receptor
2. receptor dimerizuje
3. tyrosin-kinázové domény se navzájem fosforylují
4. autofosforylace vede k navázání (recruitment) adaptérových proteinů
5. V závislosti na receptoru se aktivují „downstream“ signální dráhy –např. Ras/Raf1/MEK/MAPK kinázová dráha,
6. která vede k buněčné odpovědi

Adaptorové proteiny s SH2 doménou

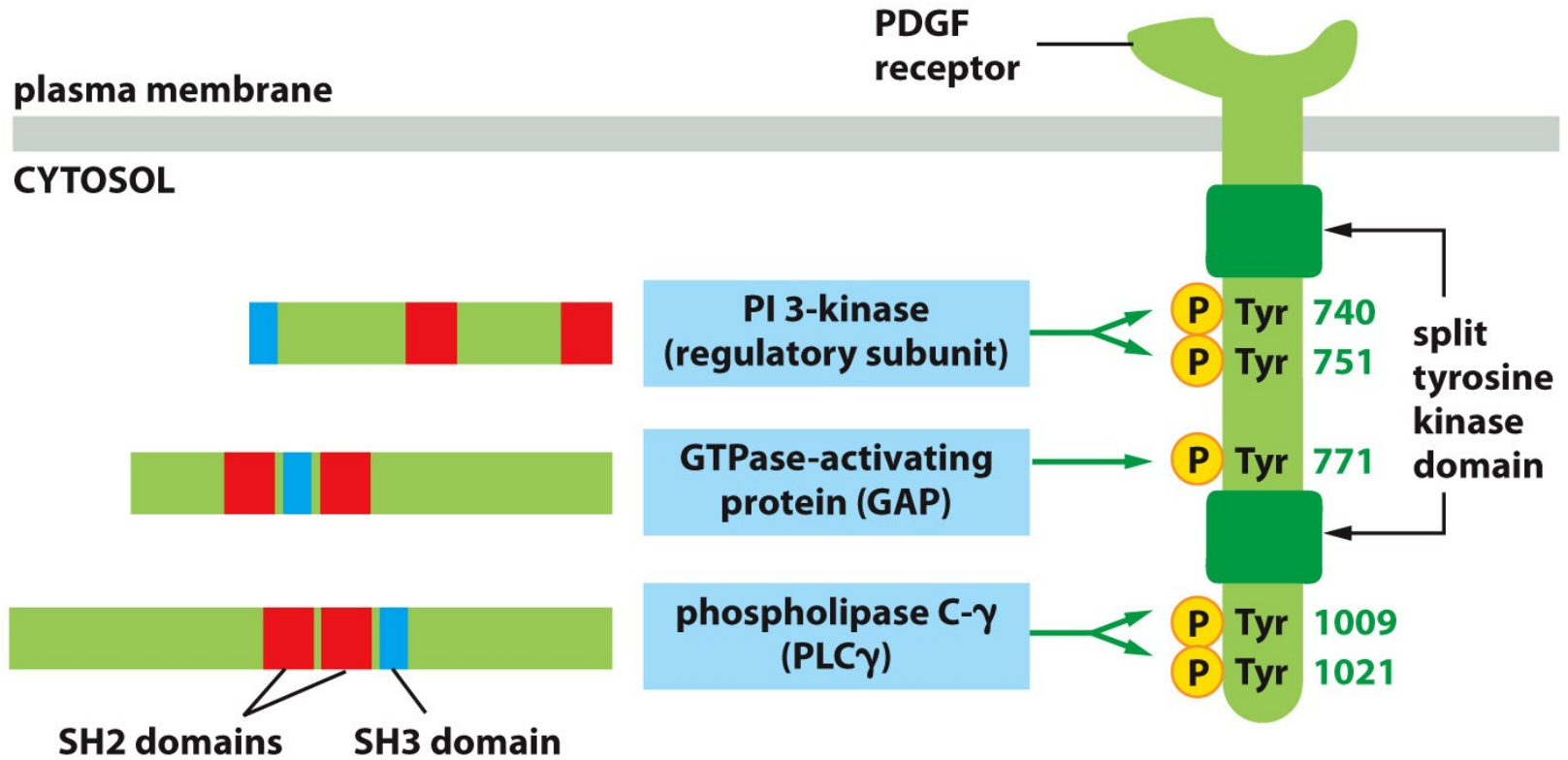

Figure 15-46a Molecular Biology of the Cell 6e (© Garland Science 2015)

Doména SH2 rozpoznává fosfo-tyrosin

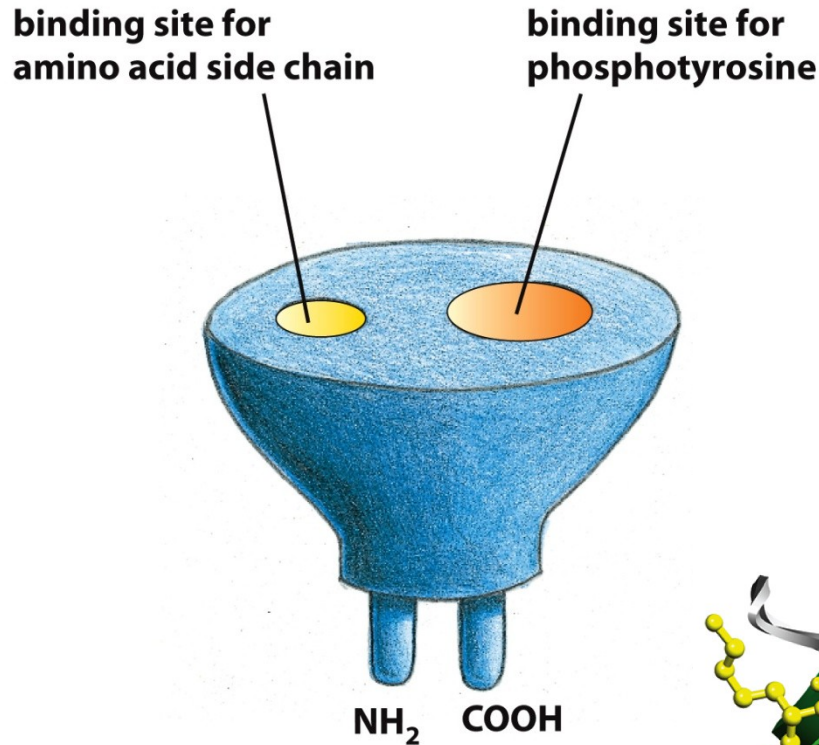

Figure 15-46c Molecular Biology of the Cell 6e (© Garland Science 2015)

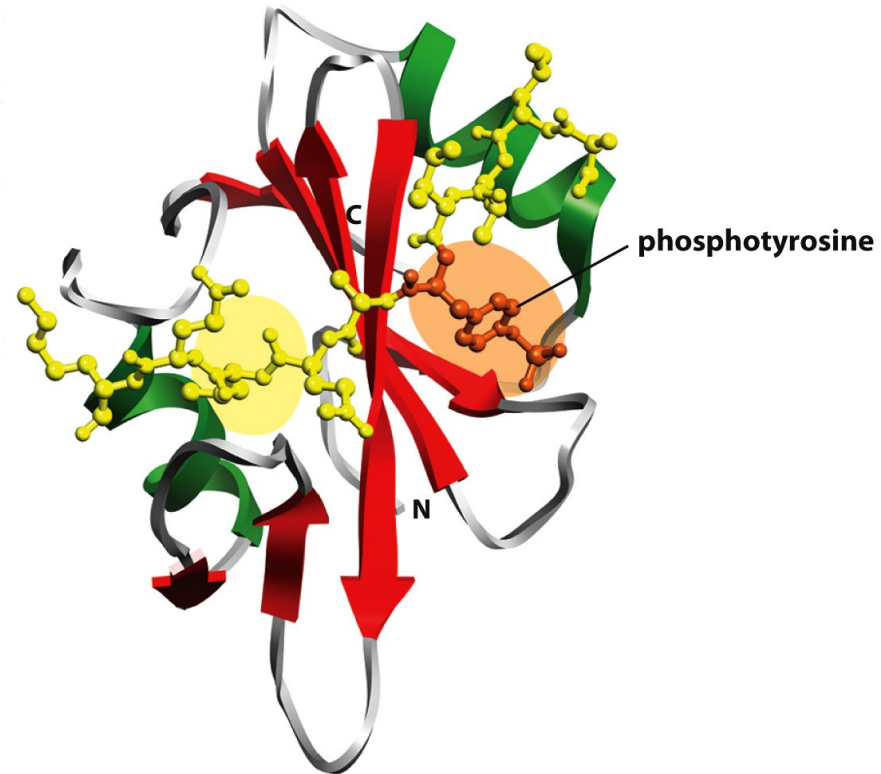

Figure 15-46b Molecular Biology of the Cell 6e (© Garland Science 2015)

Receptorové tyrosin kinázy

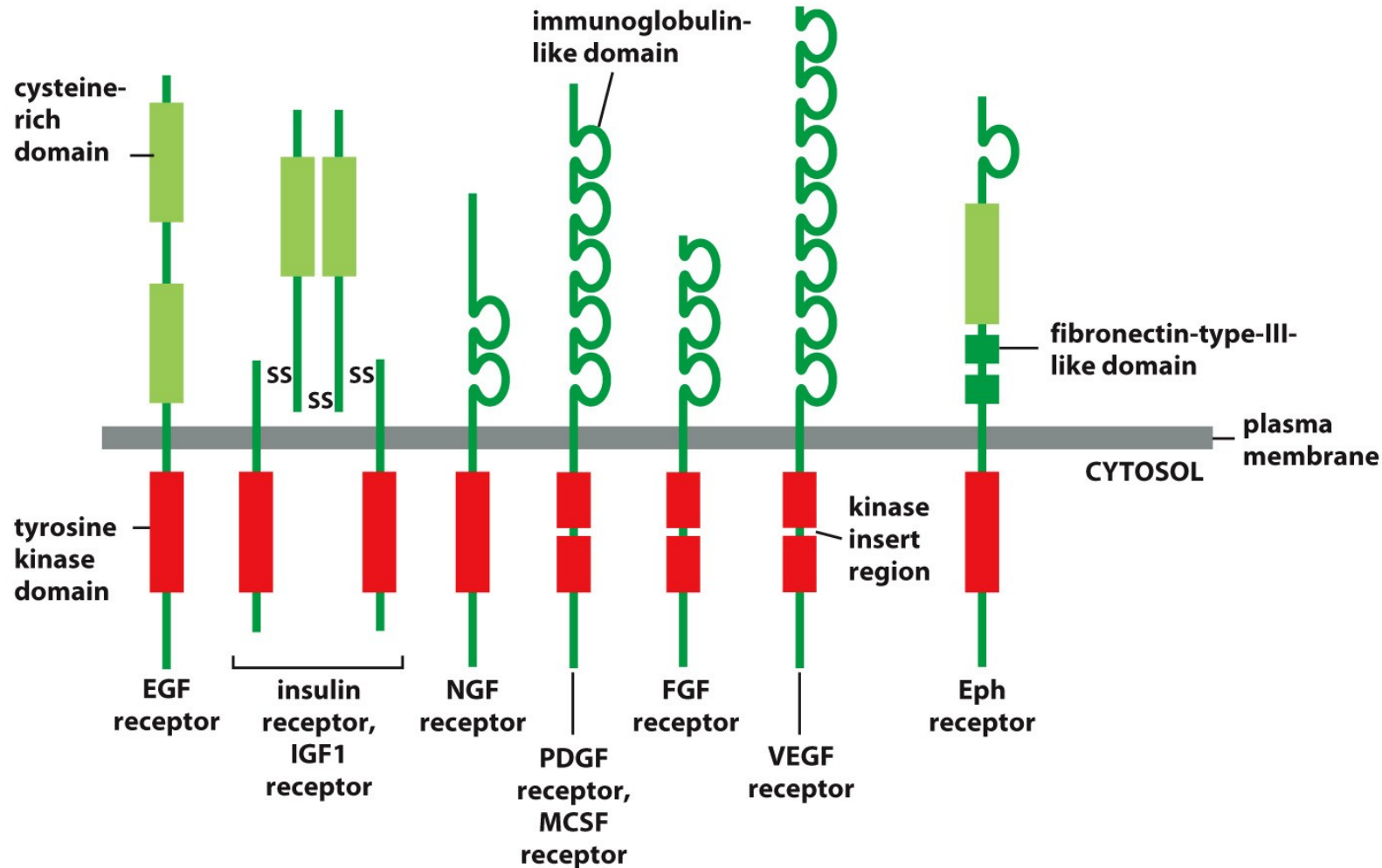

Figure 15-43 Molecular Biology of the Cell 6e (© Garland Science 2015)

Hlavní skupiny receptorových tyrosin kináz

TABLE 15–4 Some Signal Proteins That Act Via RTKs

Signal protein family	Receptor family	Some representative responses
Epidermal growth factor (EGF)	EGF receptors	Stimulates cell survival, growth, proliferation, or differentiation of various cell types; acts as inductive signal in development
Insulin	Insulin receptor	Stimulates carbohydrate utilization and protein synthesis
Insulin-like growth factor (IGF1)	IGF receptor-1	Stimulates cell growth and survival in many cell types
Nerve growth factor (NGF)	Trk receptors	Stimulates survival and growth of some neurons
Platelet-derived growth factor (PDGF)	PDGF receptors	Stimulates survival, growth, proliferation, and migration of various cell types
Macrophage-colony-stimulating factor (MCSF)	MCSF receptor	Stimulates monocyte/macrophage proliferation and differentiation
Fibroblast growth factor (FGF)	FGF receptors	Stimulates proliferation of various cell types; inhibits differentiation of some precursor cells; acts as inductive signal in development
Vascular endothelial growth factor (VEGF)	VEGF receptors	Stimulates angiogenesis
Ephrin	Eph receptors	Stimulates angiogenesis; guides cell and axon migration

Table 15-4 Molecular Biology of the Cell 6e (© Garland Science 2015)

EGF funguje jako mitogenní signál ve střevním epitelu

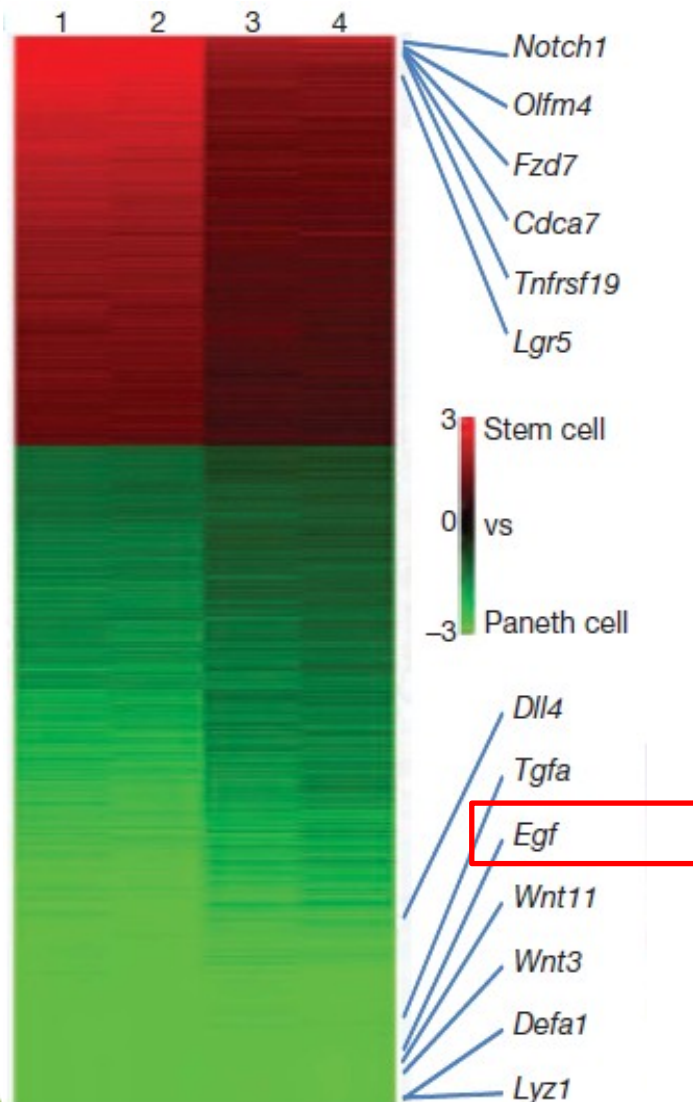

Mitogen – faktor, typicky protein, který indukuje proliferaci buněk (mitózu)

EGF (epidermální růstový faktor)
 FGF (fibroblastový růstový faktor)
 – jsou typické mitogeny

EGF funguje jako mitogenní signál ve střevním epitelu

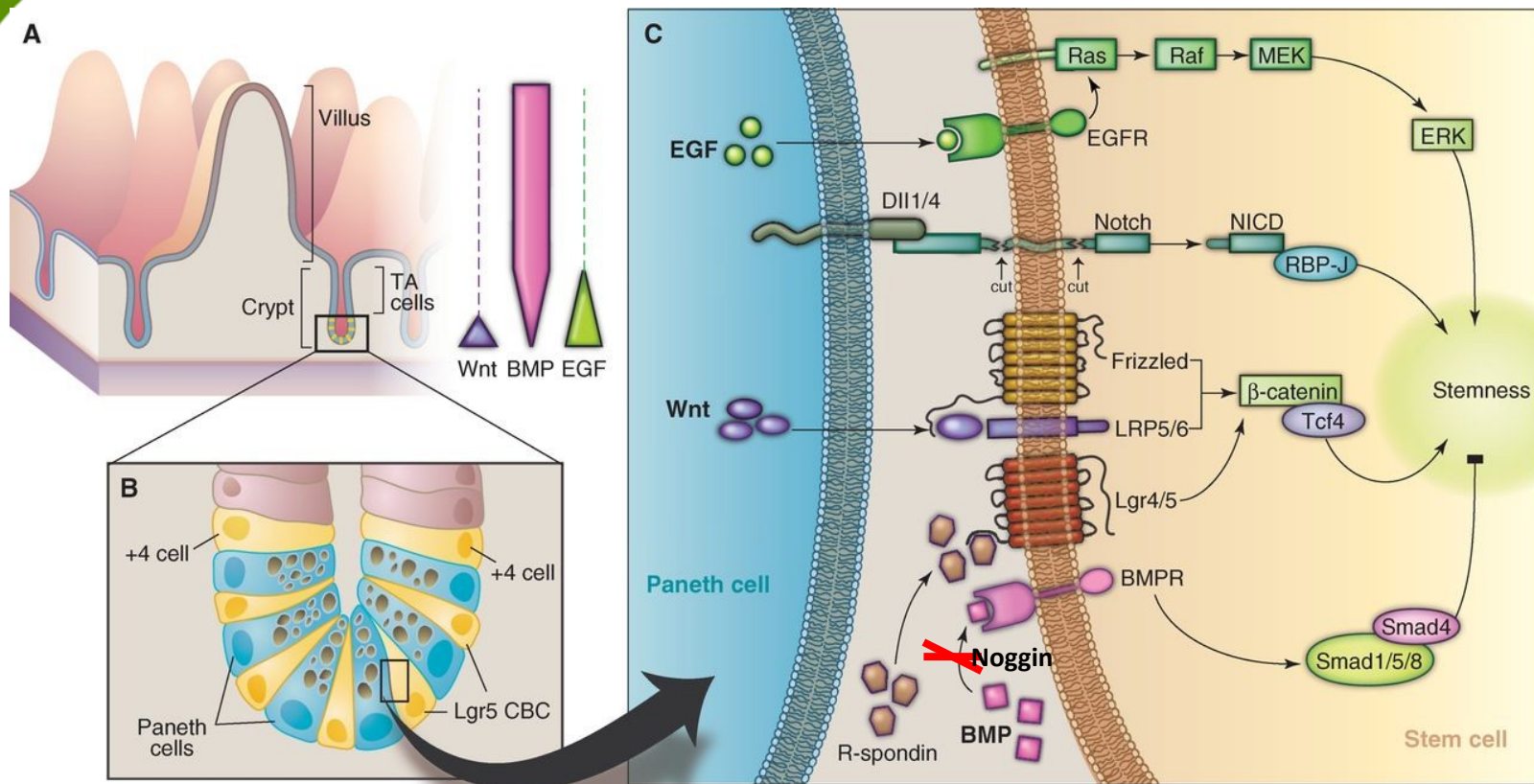

- EGF je spolu s Wnt-3a, R-spondinem a Nogginem (inhibitor BMP) základní složkou média pro kultivaci střevních organoidů

Integrace signálů vede k homeostáze

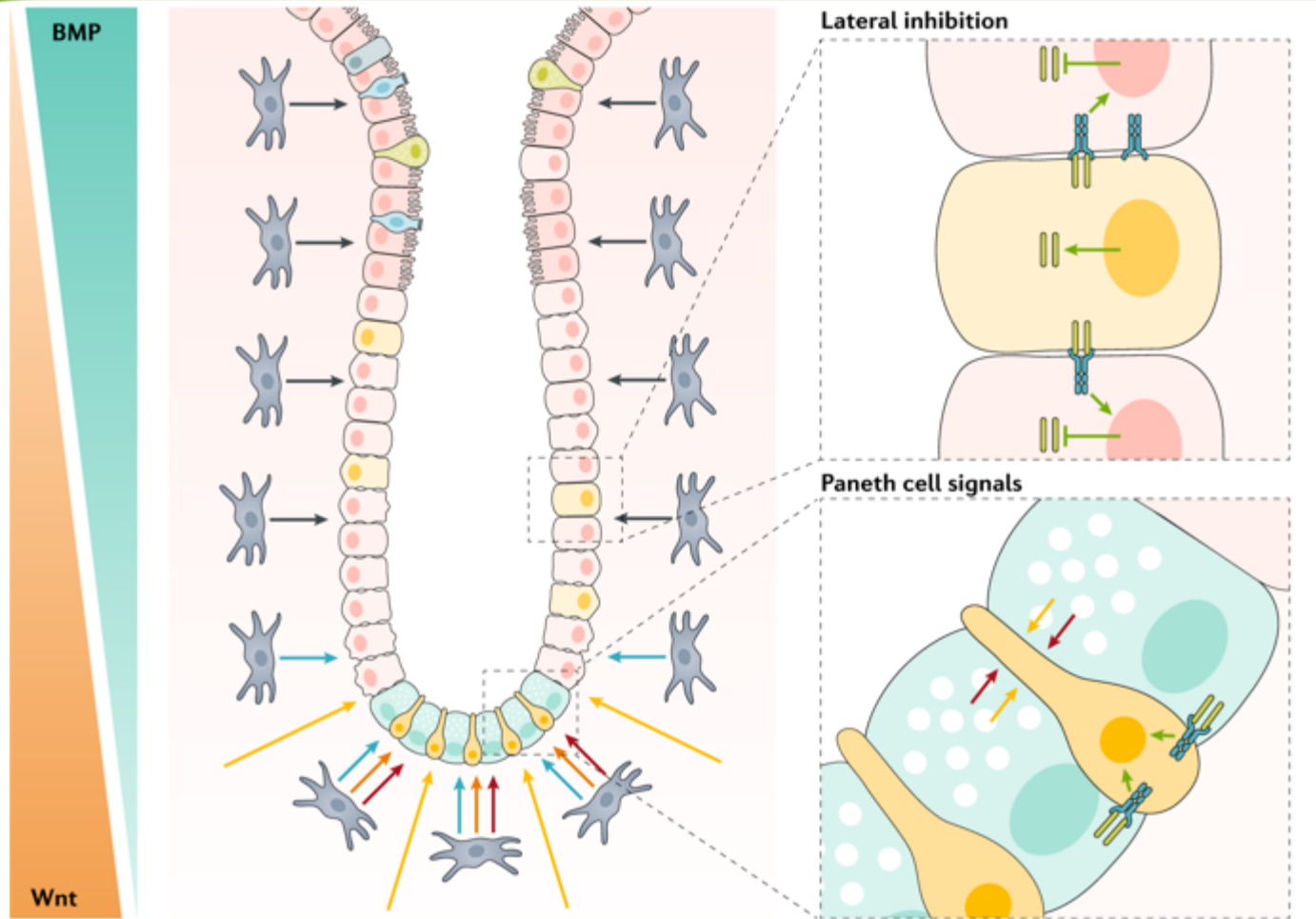

→ BMP ligands	→ R-spondins	Enterocyte	Tuft cell	Goblet cell	Paneth cell
→ BMP inhibitors	→ EGF	CBC cell	Absorptive progenitor	Secretory progenitor	Enteroendocrine cell
→ Wnt ligands	→ Notch signal	Mesenchymal cell			
Notch ligand	Notch receptor				

FGF dráha na příkladu regulace růstu kostí

Jak rostou dlouhé kosti?
- klíčová role chrupavky a růstové ploténky

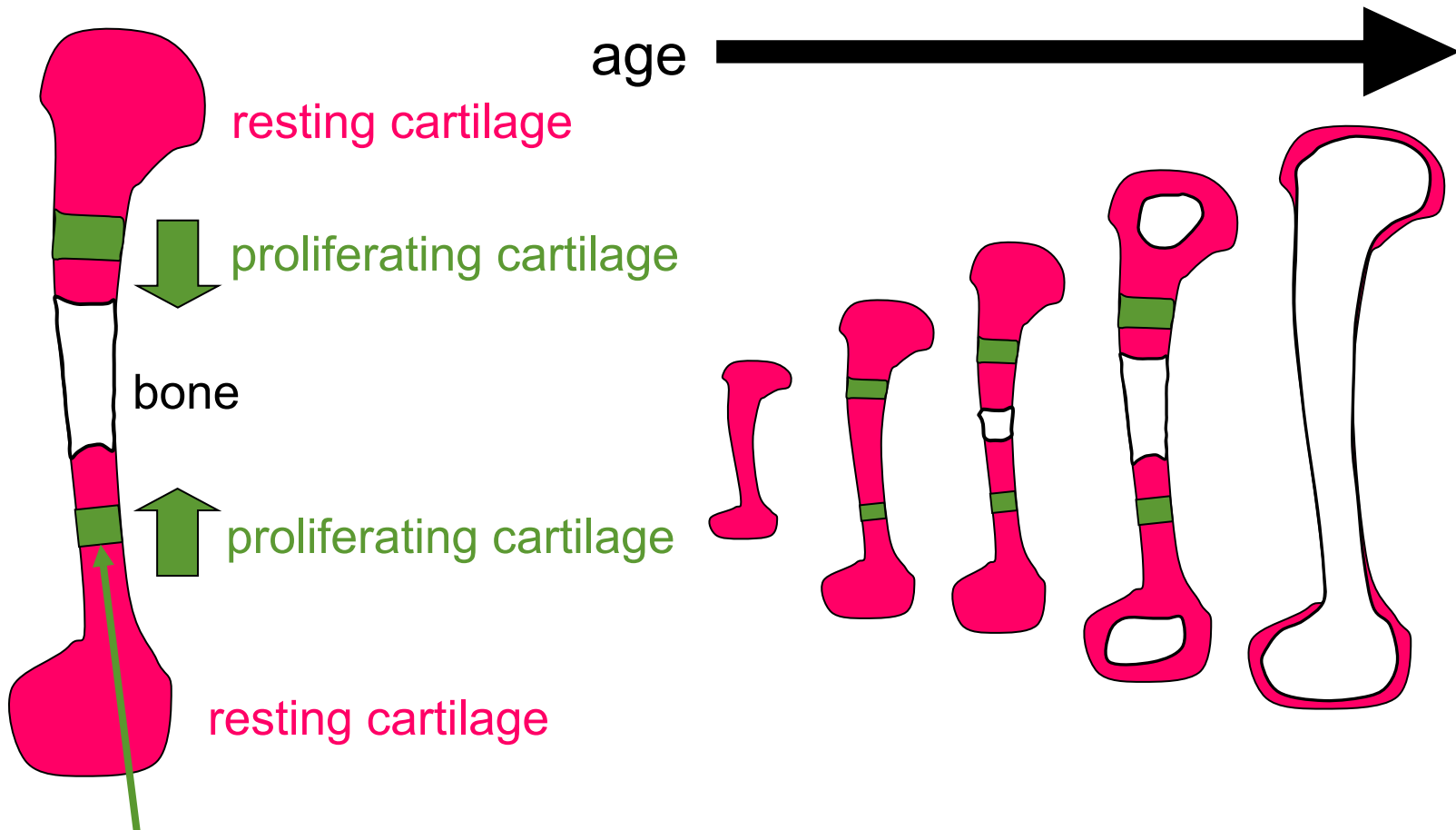

růstová ploténka (growth plate) – zaniká v dospělosti

Aktivující mutace v FGFR3 způsobují skeletální dysplázie

Hypochondroplasia
Achondroplasia
SADDAN
Thanatophoric Dysplasia

STATURE

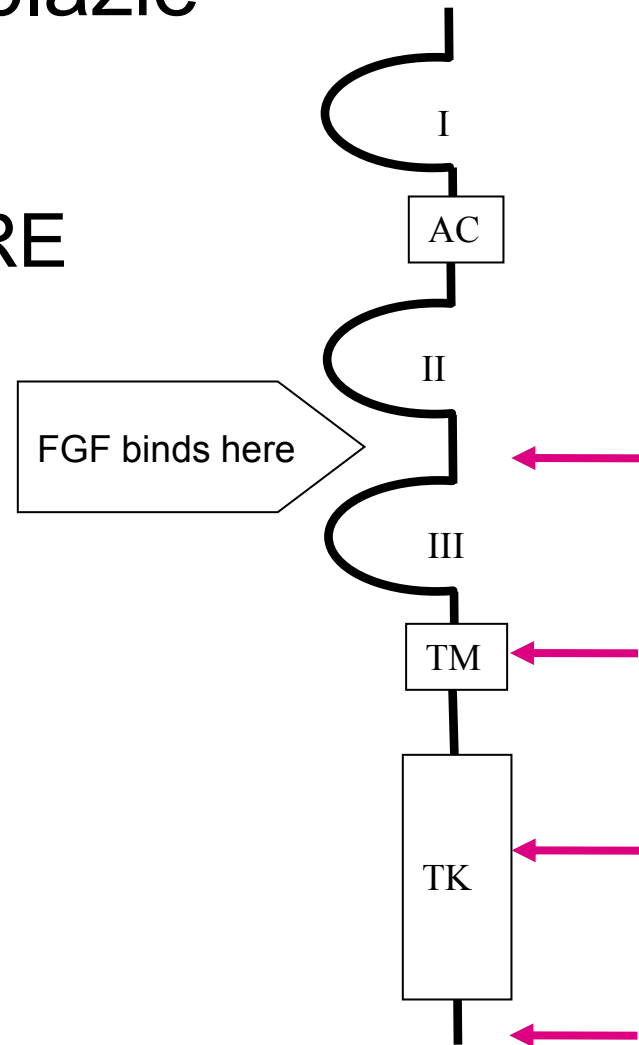



Achondroplasia

FGF-FGFR3 dráha blokuje růst dlouhých kostí

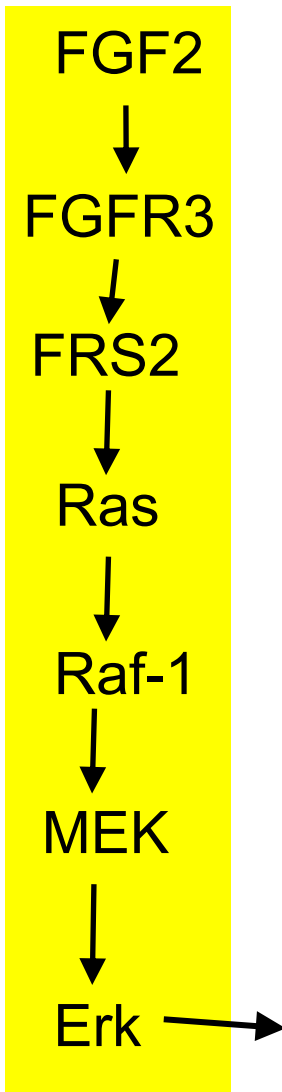

Růstová ploténka v detailu

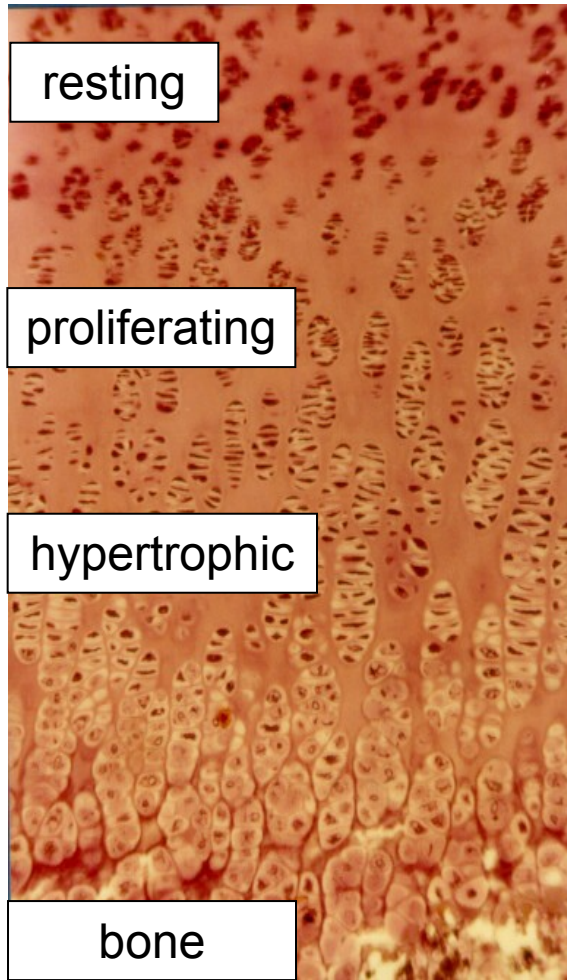
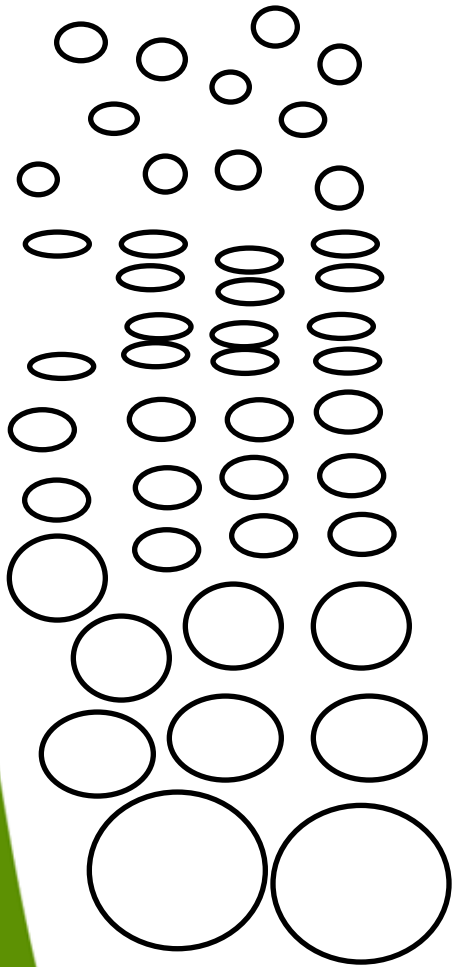

healthy

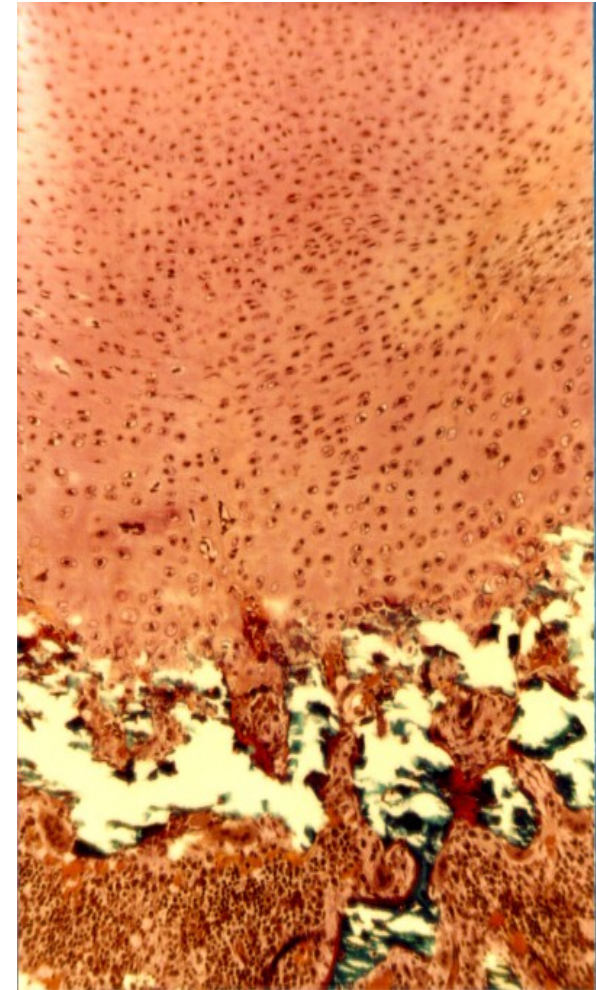

TD

Lék je nyní v závěrečné fázi klinického testování. Jedná se o stabilní formu malé bílkoviny, která je silným stimulatorem růstu kostí. „U genetických poruch růstu neexistuje většinou cílená léčba. Achondroplazie je jedním z prvních syndromů, u kterého se na základě výzkumu patologických mechanismů podařilo lék vyvinout,“ uzavřel téma Pavel Krejčí.



Kontakt pro média:

Mgr. Dana Lipovská, Tisková mluvčí, tel. +420 543 182 006, dana.lipovska@fnusa.cz