

## 2. I Non-Self Sustained Electrical Discharges

FB242 Gas discharges: physical  
mechanisms and applications



Funded by  
the European Union  
NextGenerationEU



CZECH  
RECOVERY  
PLAN



MINISTRY OF EDUCATION,  
YOUTH AND SPORTS

# Non-Selfsustained el. Discharges

A small electric current is flowing with the current densities  $10^{-12}$  až  $10^{-6}$  A/m<sup>2</sup> is always flowing in a weak el. field near the ground surface due to **background ionization** due to natural processes such as cosmic rays, radioactive decay of radioactive materials (including uranium, thorium, and radium) existing naturally in soil and rock.

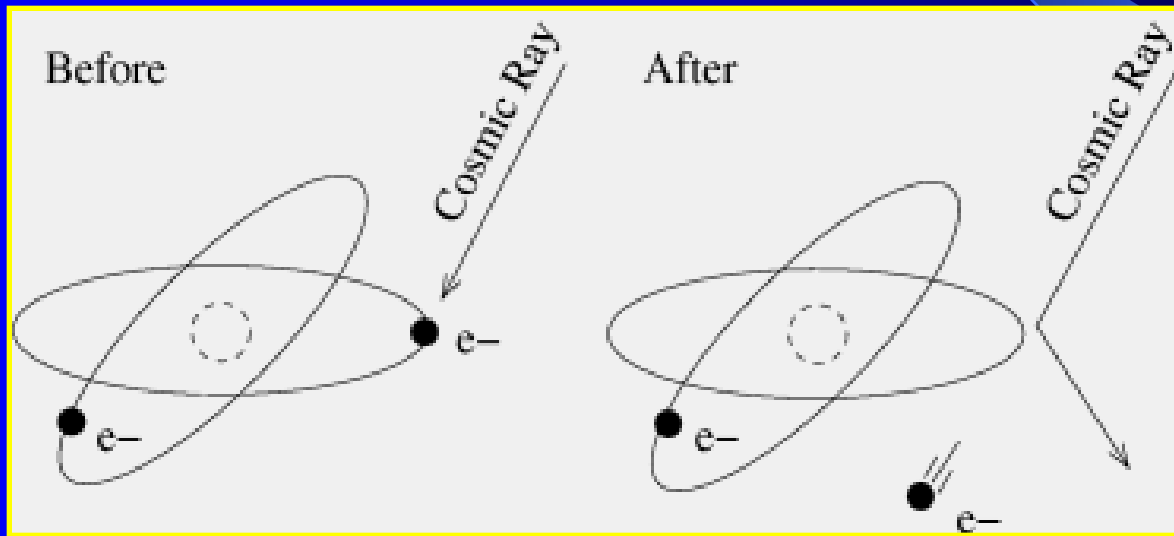

*external ionization source*

**non-selfsustained el. discharges**

# Non-self sustained dark Townsend discharge (a typical case)



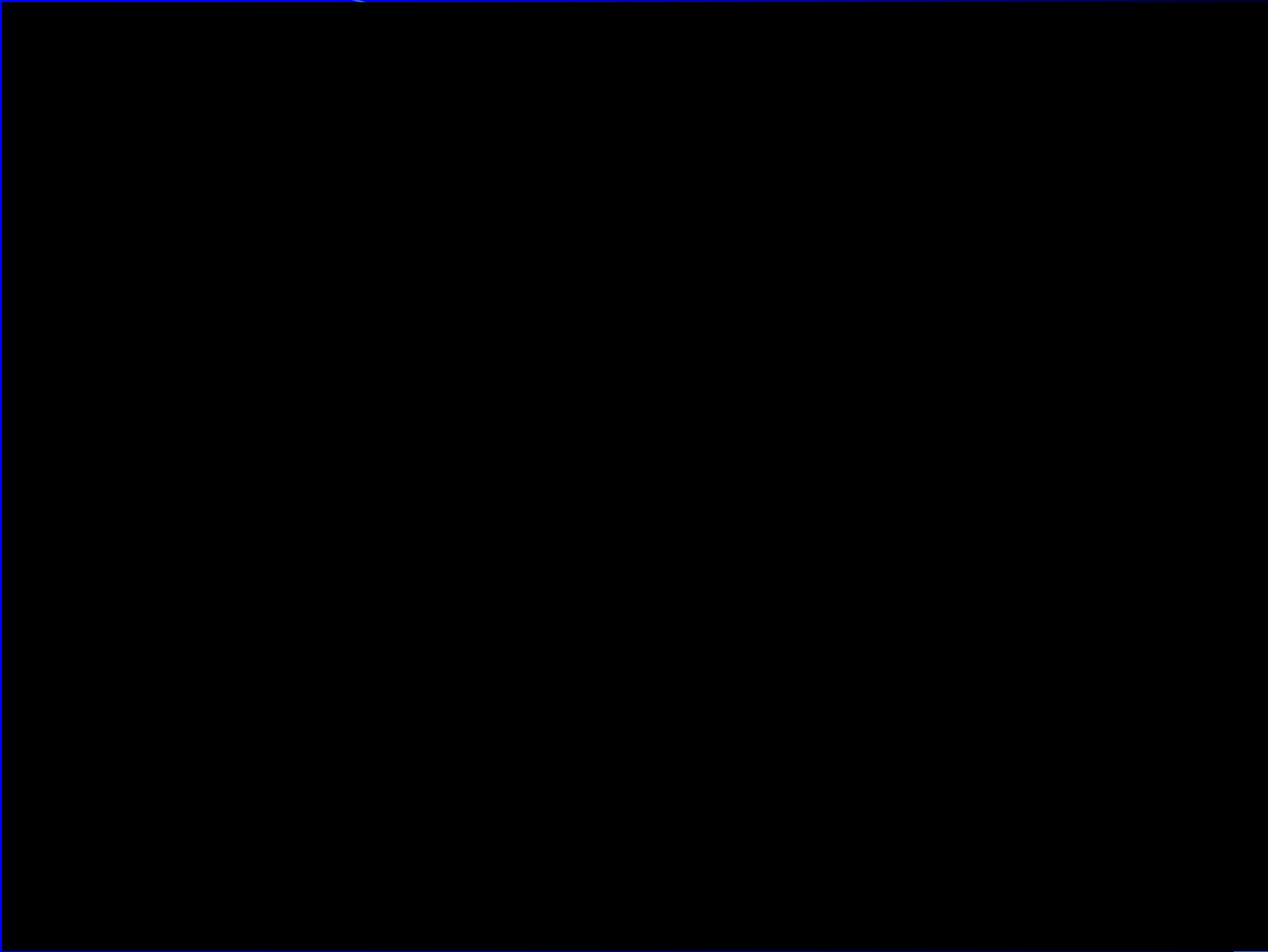

**Volt-ampere characteristics of non-self-sustained el. discharges**

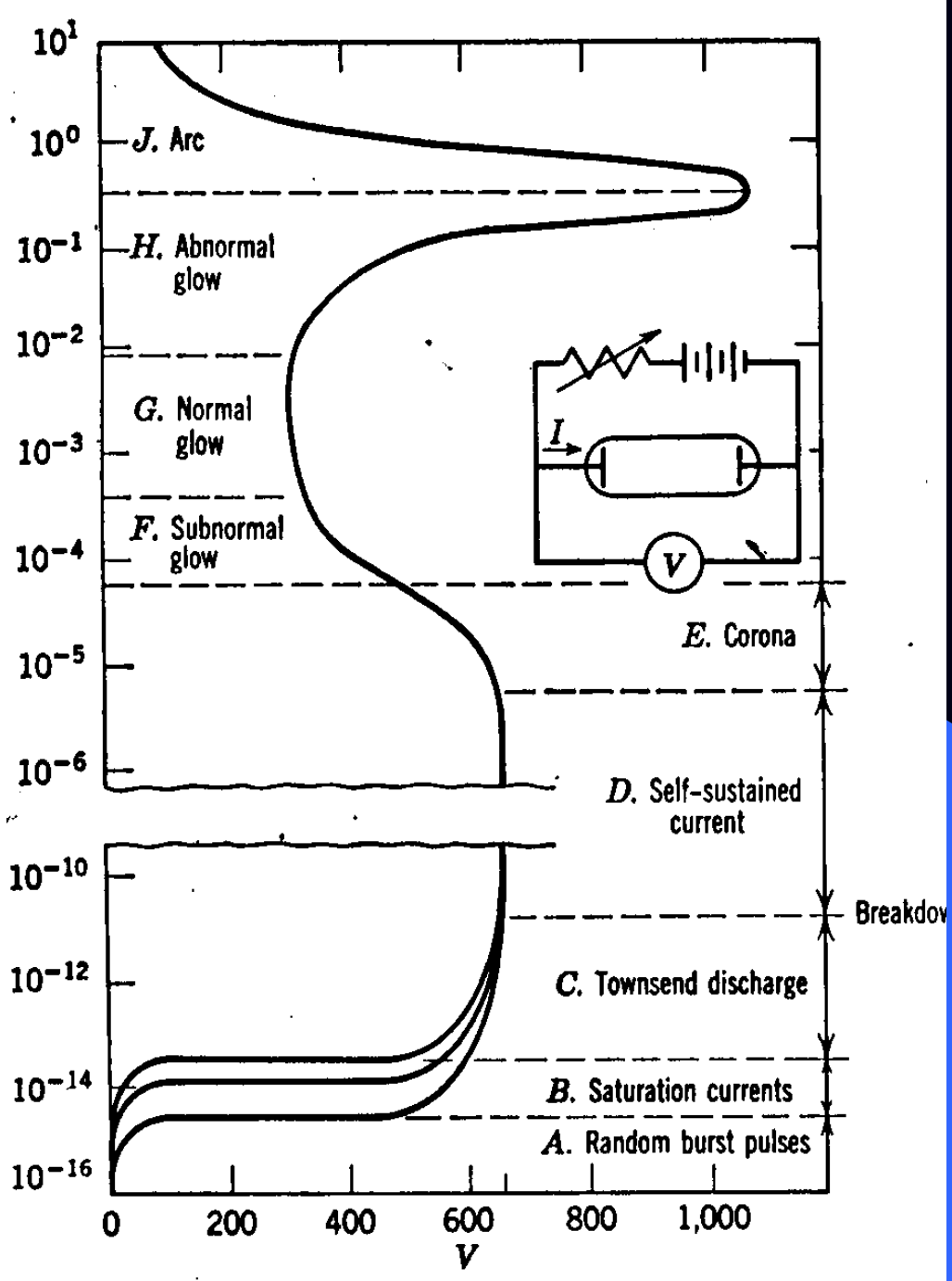

# Plasma recombination

ions plasma  
electron  
atoms gas

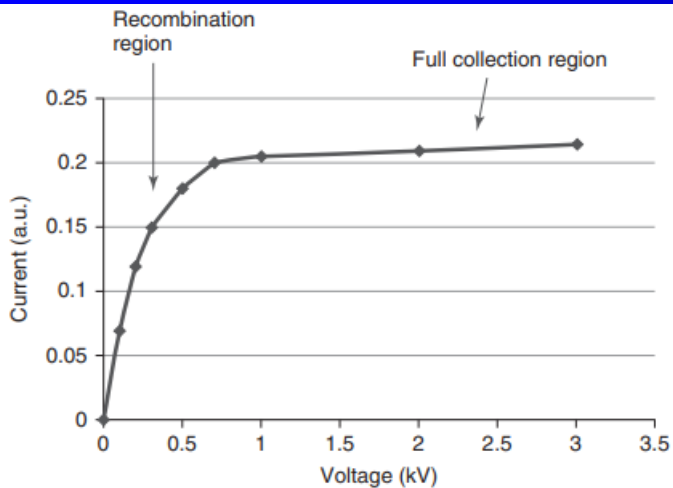
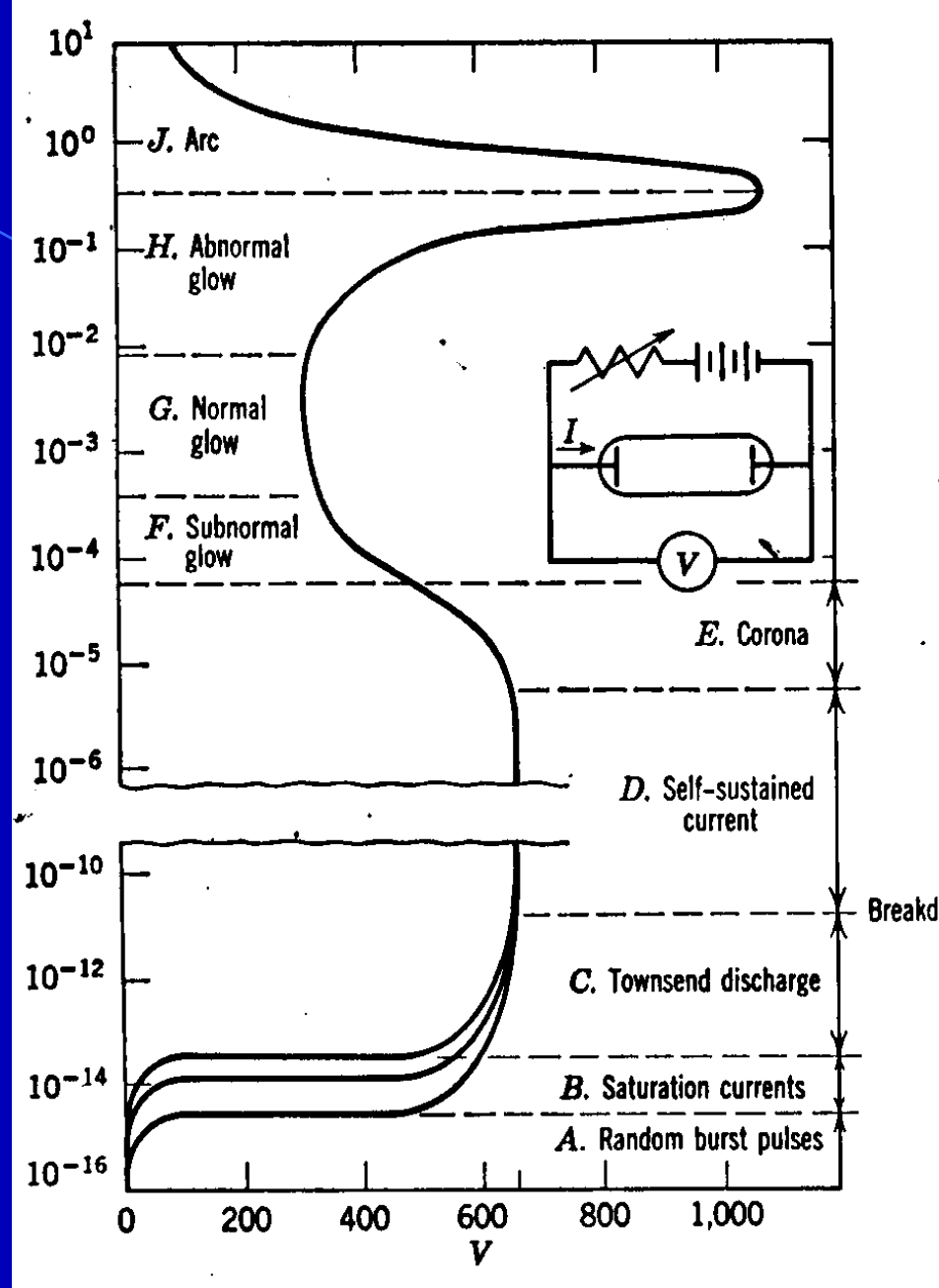
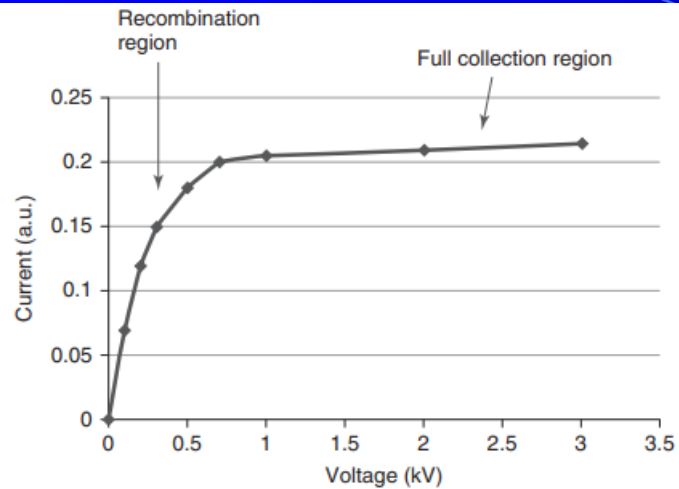
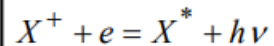

Figure 1.2 Typical current versus applied voltage curve, measured with an ionization chamber, when irradiated by a flux of photons or charged particles.

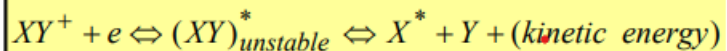

**Figure 1.2** Typical current versus applied voltage curve, measured with an ionization chamber, when irradiated by a flux of photons or charged particles.

### Radiative recombination



### Dissociative recombination



### Three body recombination

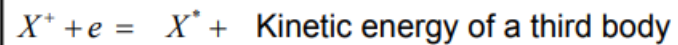

# Practical Gaseous Ionisation Detection Regions

This diagram shows the relationship of the gaseous detection regions, using an experimental concept of applying a varying voltage to a cylindrical chamber which is subjected to ionising radiation. Alpha and beta particles are plotted to demonstrate the effect of different ionising energies, but the same principle extends to all forms of ionising radiation.

The ion chamber and proportional regions can operate at atmospheric pressure, and their output varies with radiation energy. However, in practice the Geiger region is operated at a reduced pressure (about  $1/10^{\text{th}}$  of an atmosphere) to allow operation at much lower voltages; otherwise impractically high voltages would be required. The Geiger region output does not differentiate between radiation energies.

Variation of ion pair charge with applied voltage

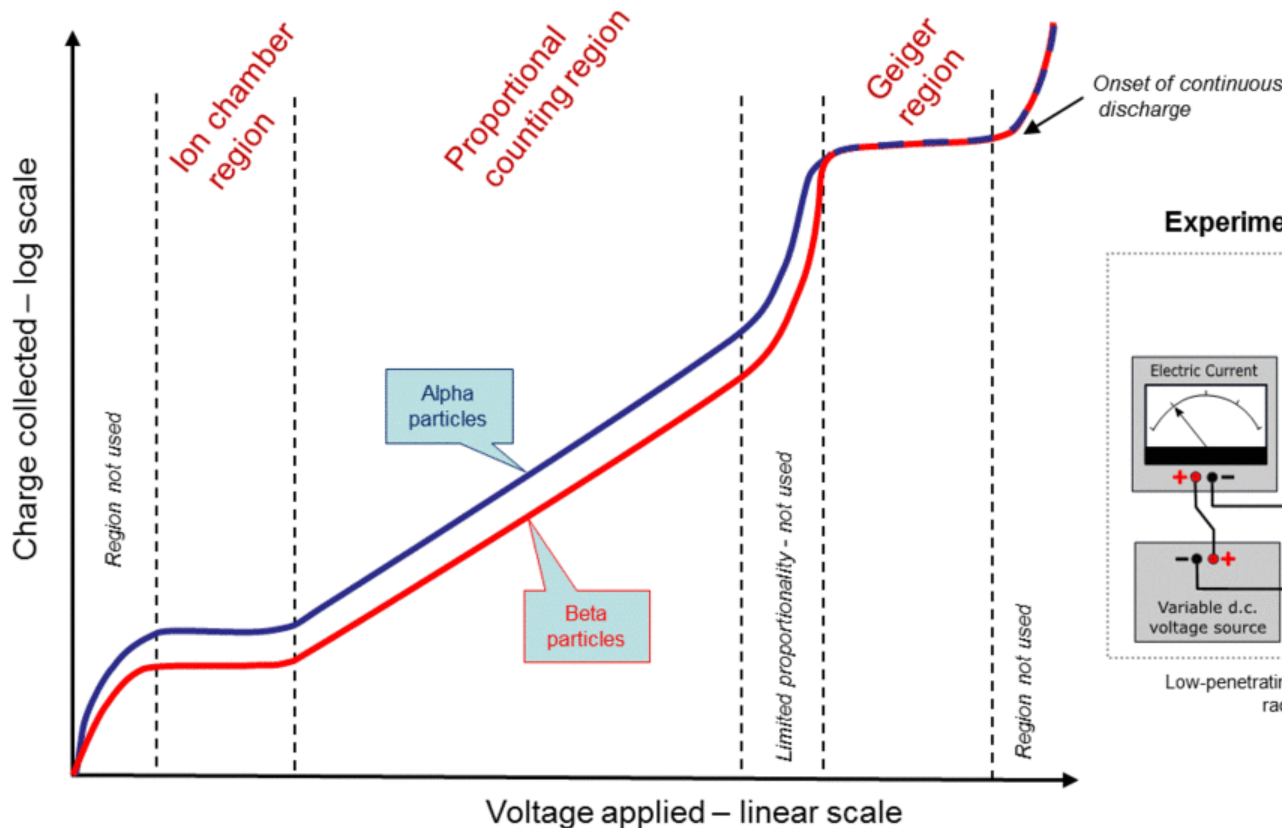

Experimental set-up of a cylindrical chamber

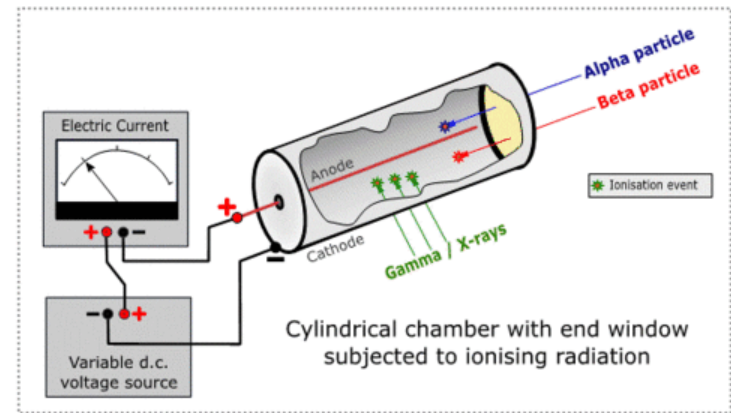

Low-penetrating radiation enters via an end window, but high-penetrating radiation can also enter via the cylinder side wall.



Ionization-free region (recombination region + saturation region)

Townsend first ionization region

Townsend second ionization region

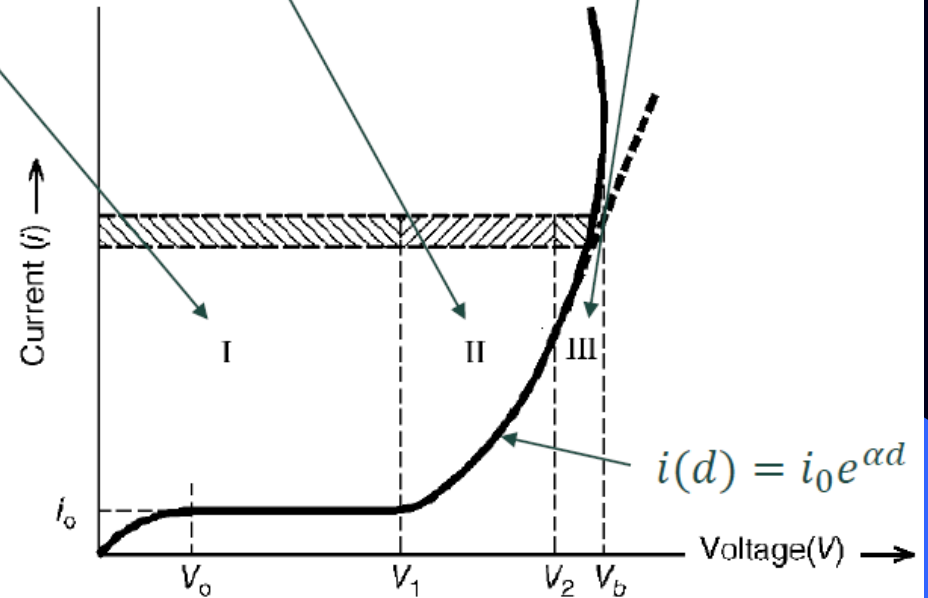
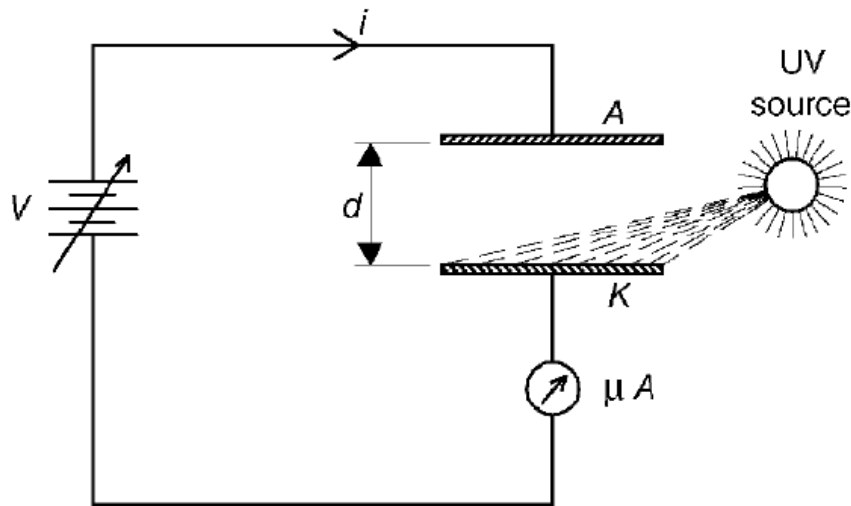

$V > V_1$   
Electron avalanche ionization

- Townsend's avalanche process cannot be sustained without external sources for generating seed electrons.

# Which figure is wrong ?

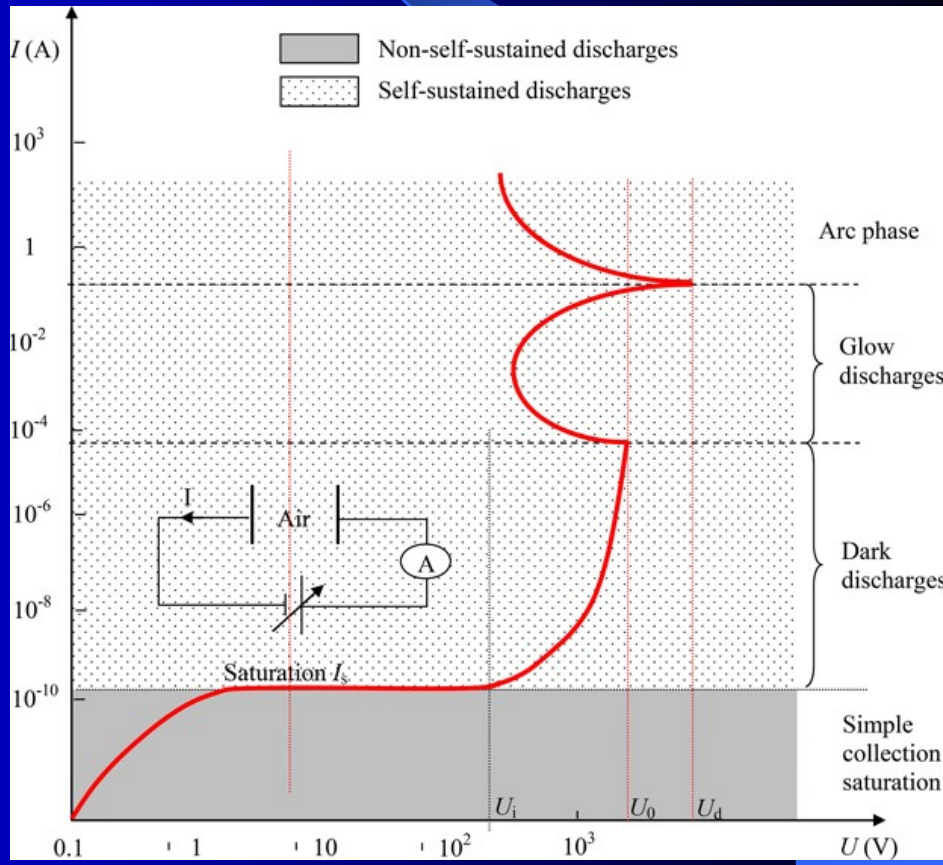
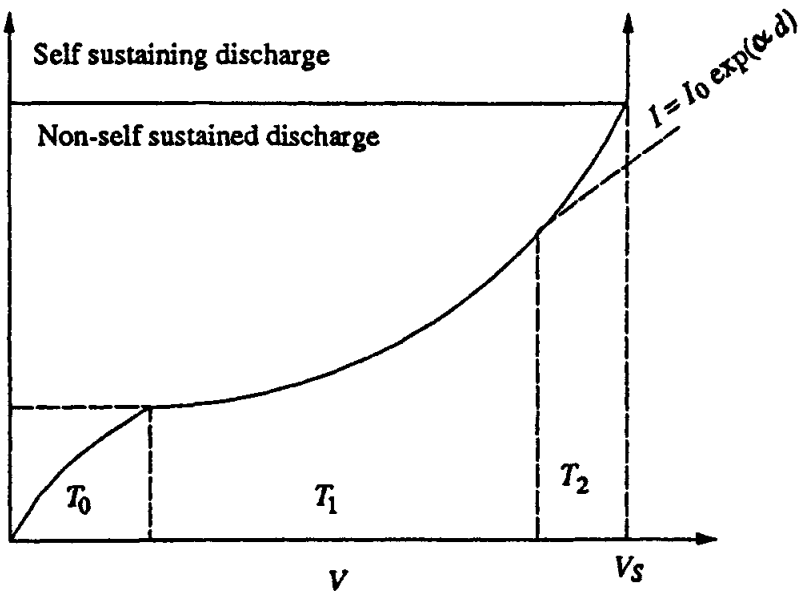

a) **Elastic collision**  $\Delta\varepsilon \sim m/M$  due to the conservation of the momentum and energy

b) **Excitation**

c) **Ionization by the electron impact**

(Why the ionization by positive ion impact can be neglected ???)

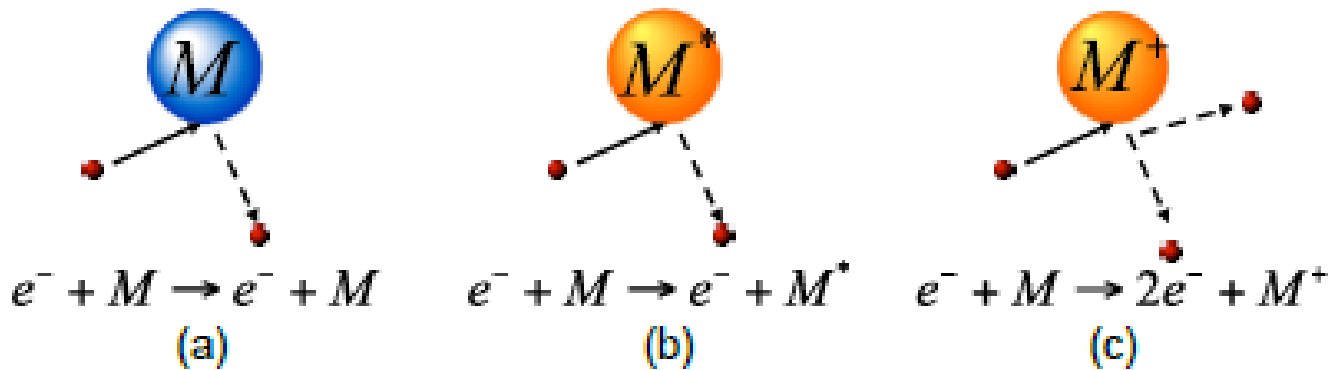

Which electrode is the cathode ?  
(Please consider  $\Delta\varepsilon \sim m/M$ )

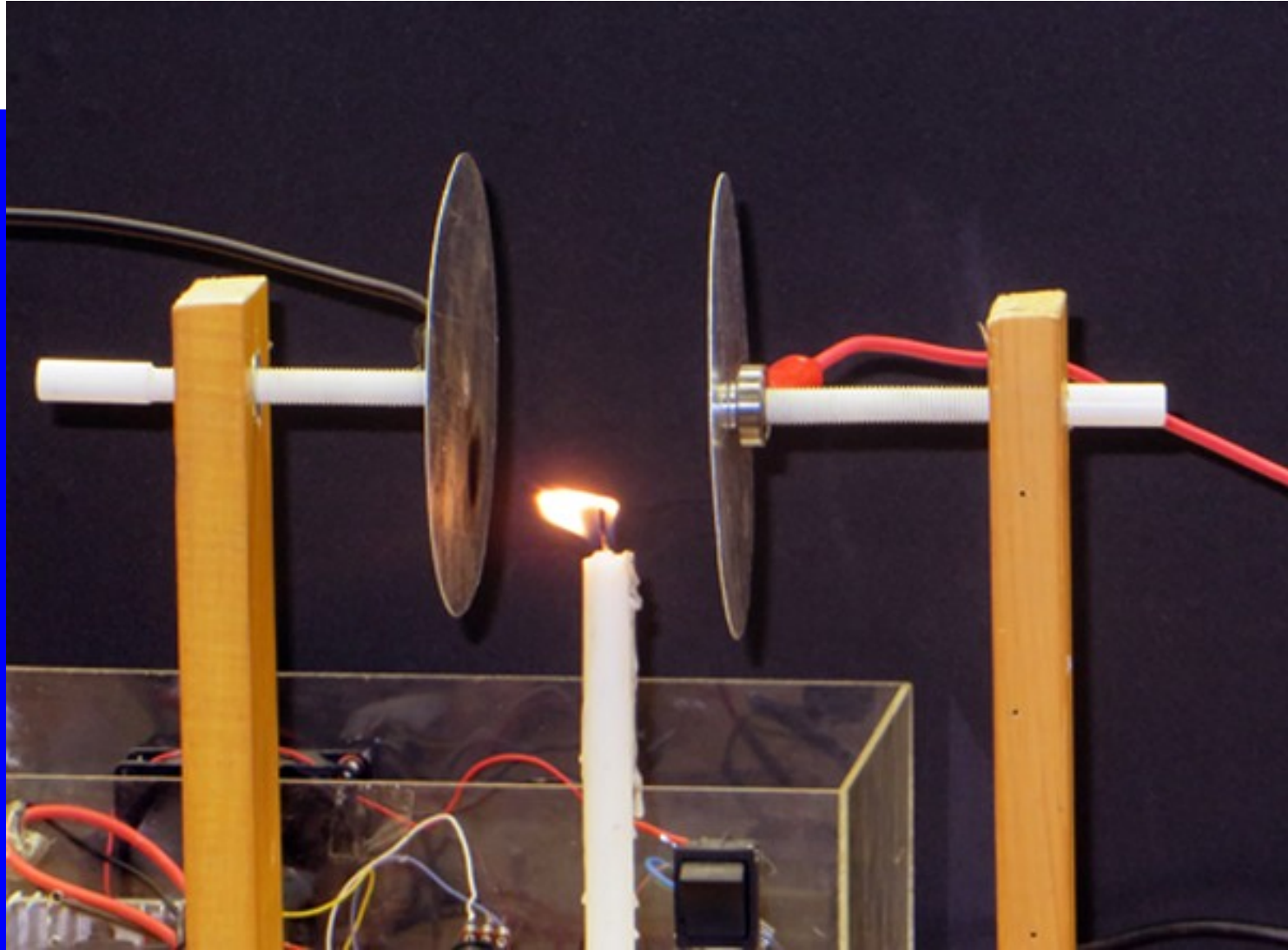

# Elastic and inelastic electron collisions in

Ar

(the processes rate constants vs. Electron energy in electronvolts  
(An electron emperature of **11 600 K** corresponds to the electron kinetic energy of 1 eV.)

[Day1View3Mar08.dvi \(berkeley.edu\)](#)

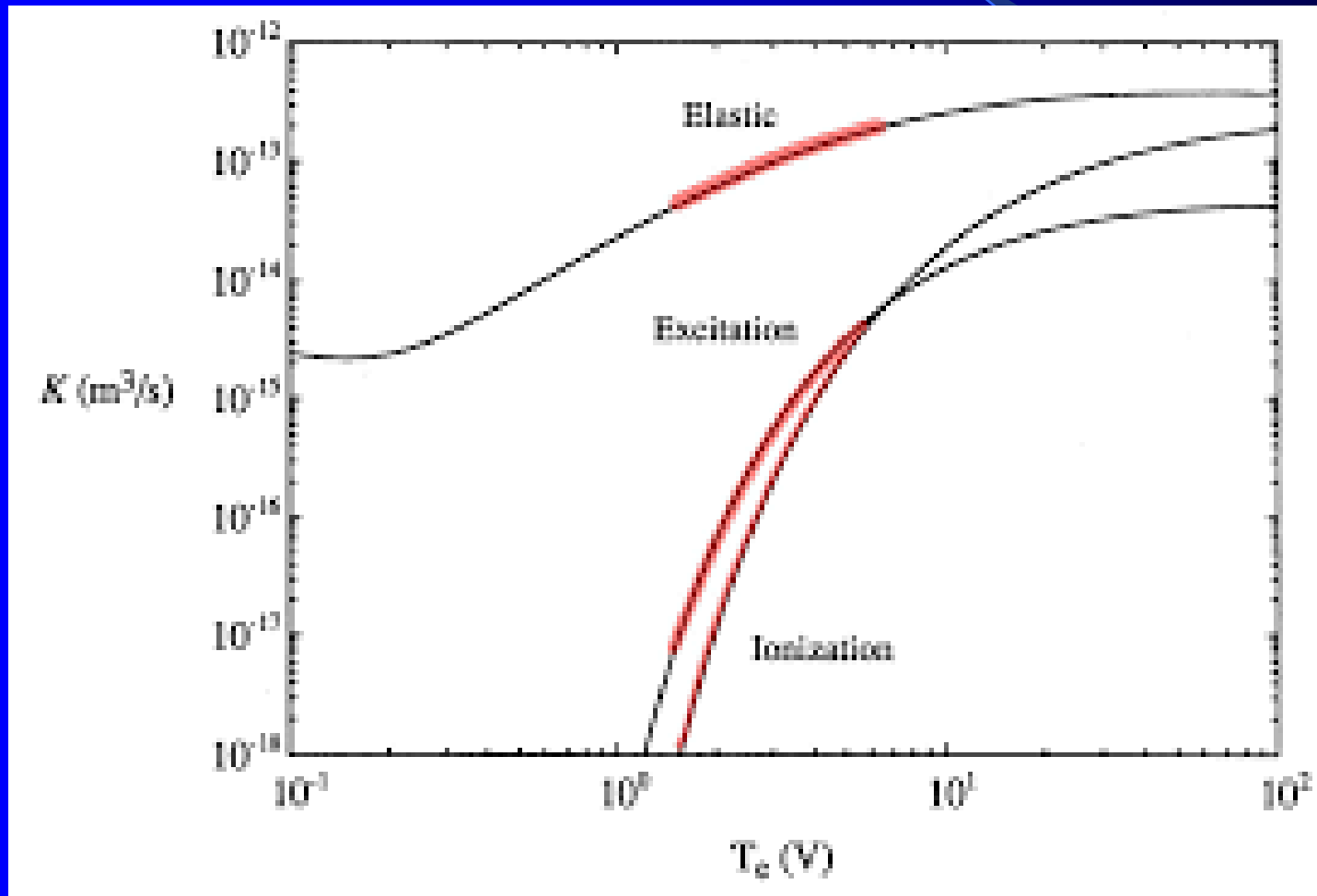

# Elastic and inelastic electron collisions: **cross section** gas

$$\sigma = 1/\lambda \cdot N$$

SI

mean free path  
number density

If the particles in the gas interact by a force with a larger range than their physical size, then the cross section is a larger effective area that may depend on a variety of variables such as the energy of the particles.

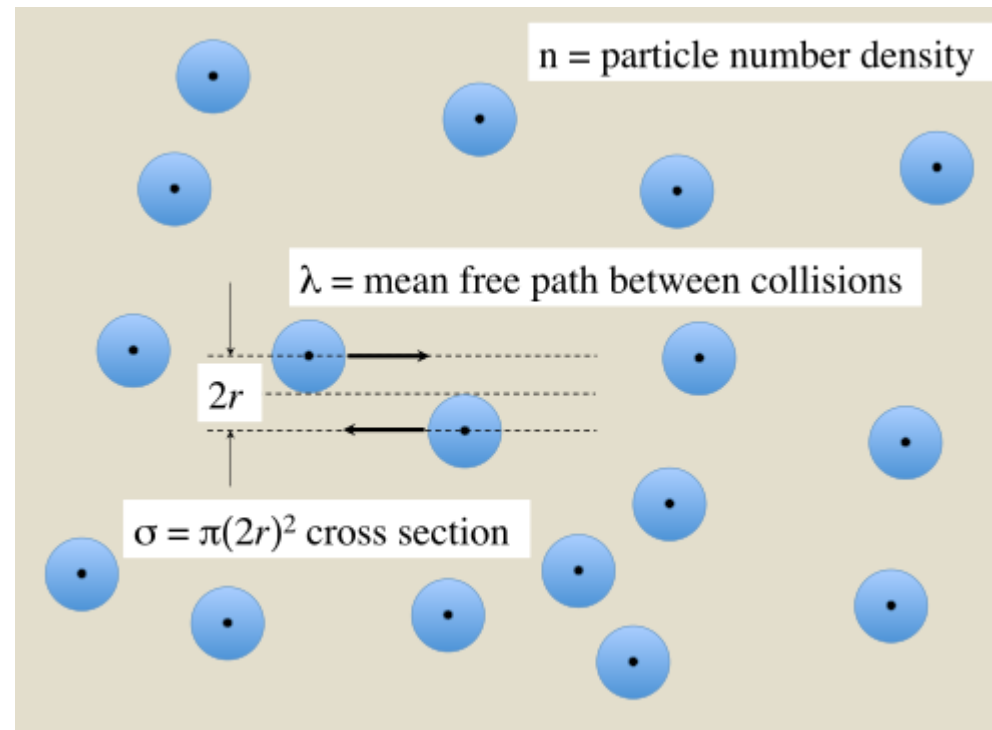

- Cross section for scattering of an electron by a neutral atom:

$$\sigma_n \sim \pi a_0^2$$

- Mean free path:

$$\lambda_{mfp} = (n_n \sigma_n)^{-1}$$

- Collision frequency:

$$\nu_n = n_n \sigma_n v$$

# Elastic and inelastic electron collisions: cross section

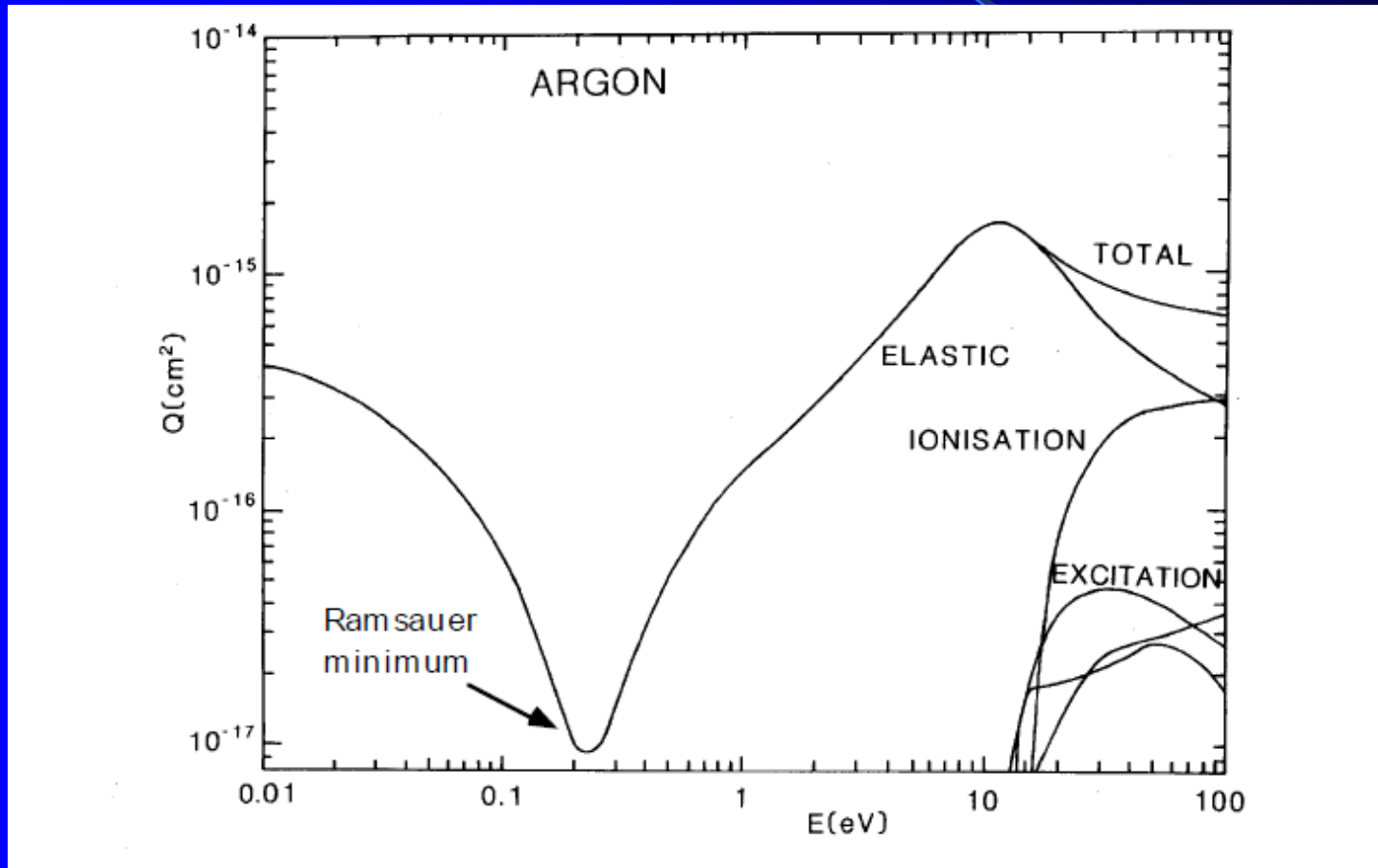



## Ramsauer–Townsend effect.

- In 1912 and 1922 Ramsauer and Townsend respectively observed that for slow-moving electrons in argon, krypton, or xenon, the probability of collision between the electrons and gas atoms obtains a minimum value for electrons with a certain amount of kinetic energy (about 1 electron volts for xenon gas). This is the quantum-mechanical Ramsauer–Townsend effect.

# Townsend electron avalanche

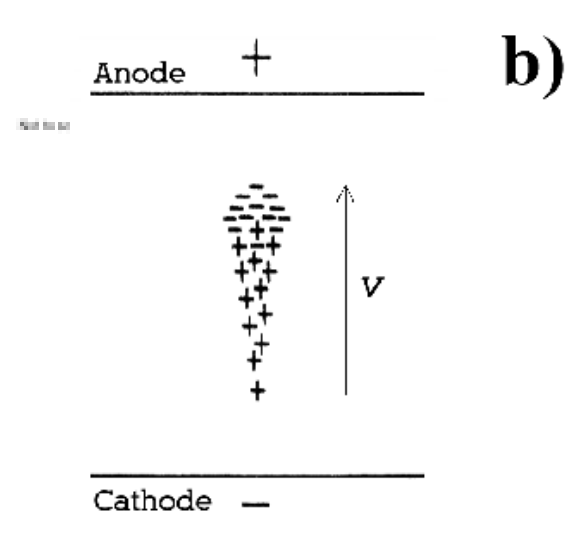
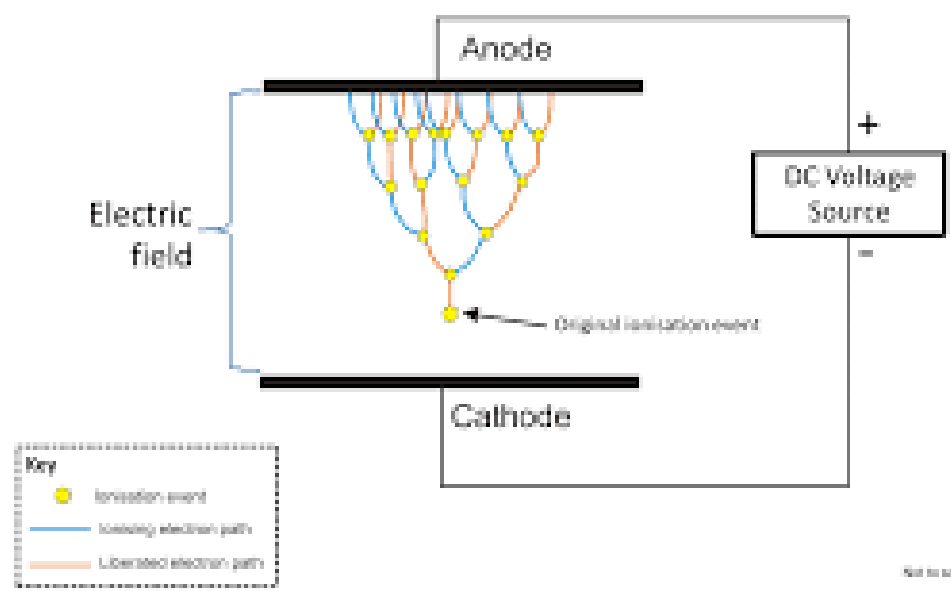

**Electron avalanche in a laboratory experiment**

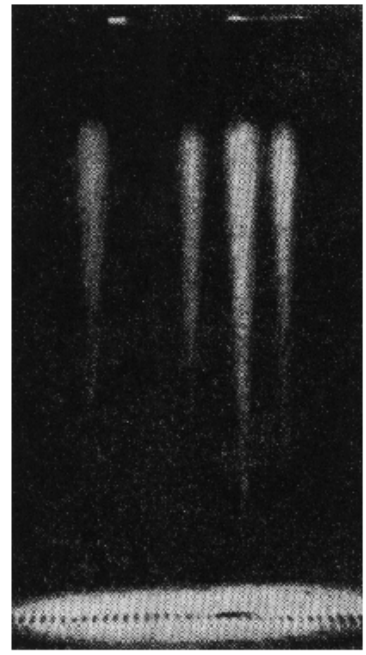

# 1st Townsend coefficient $\alpha$

$\alpha$

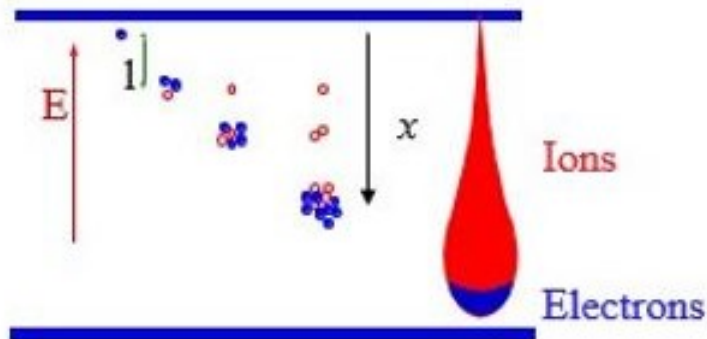

At each mean free path for ionization, electrons create an electron-ion pair; results an exponential increase of charge, with fast electrons on the front and slow ions left behind.

Incremental increase of the number of electrons in the avalanche:

$$dn = n \alpha dx \quad n(x) = n_0 e^{\alpha x}$$

Multiplication factor or Gain:

$$M(x) = \frac{n}{n_0} = e^{\alpha x}$$

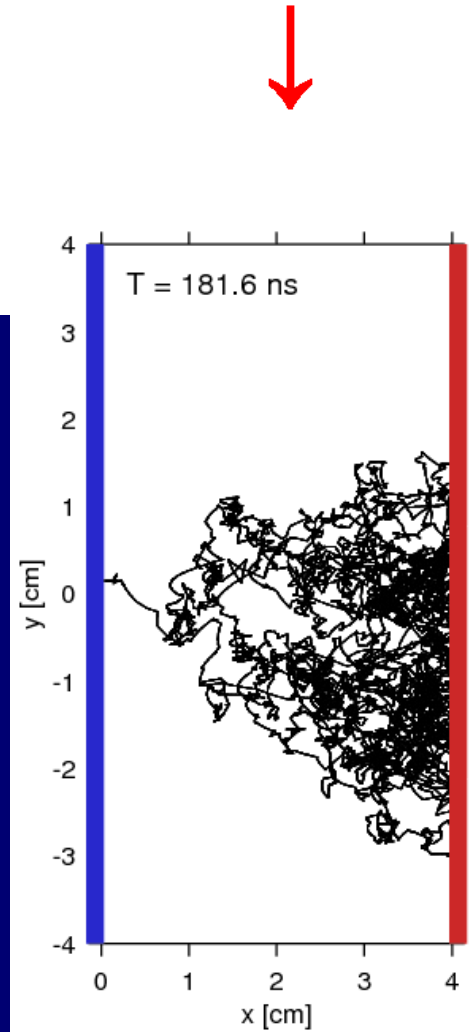

$$\alpha/p \approx Ae^{-Bp/E}$$

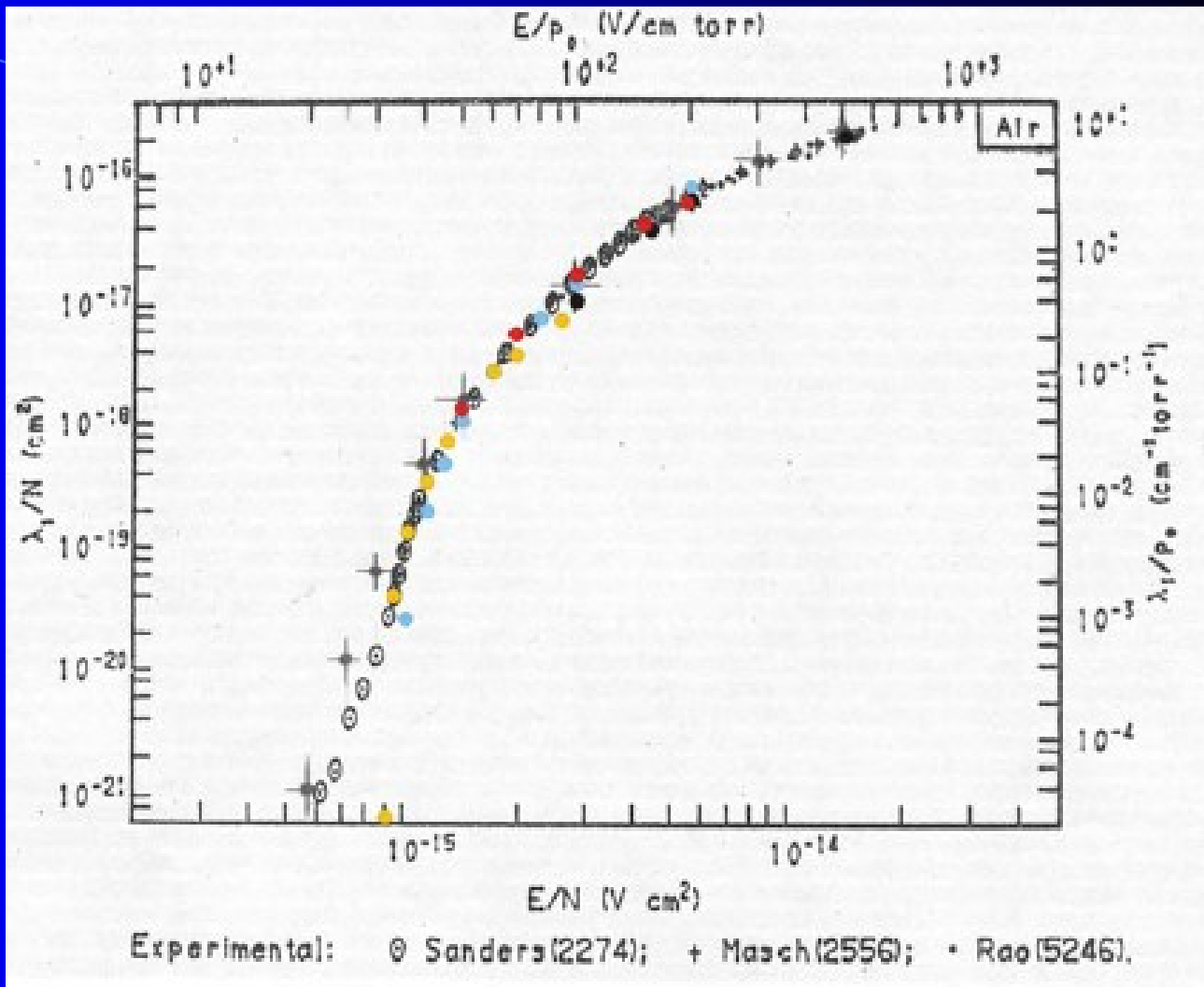

The **townsend** (symbol Td) is a physical unit of the reduced electric field (ratio E/N), where E is electric field and N is concentration of neutral particles.

$$1 \text{ Td (Townsend)} = 10^{-17} \text{ V.cm}^{-2}$$

# Townsend ionization coefficient $\alpha$ and electron attachment coefficient $\eta$ (eta) in air

$\eta$  - the probability that an electron drifting through a gas under the influence of a uniform electric field will undergo electron attachment in a unit distance of drift.

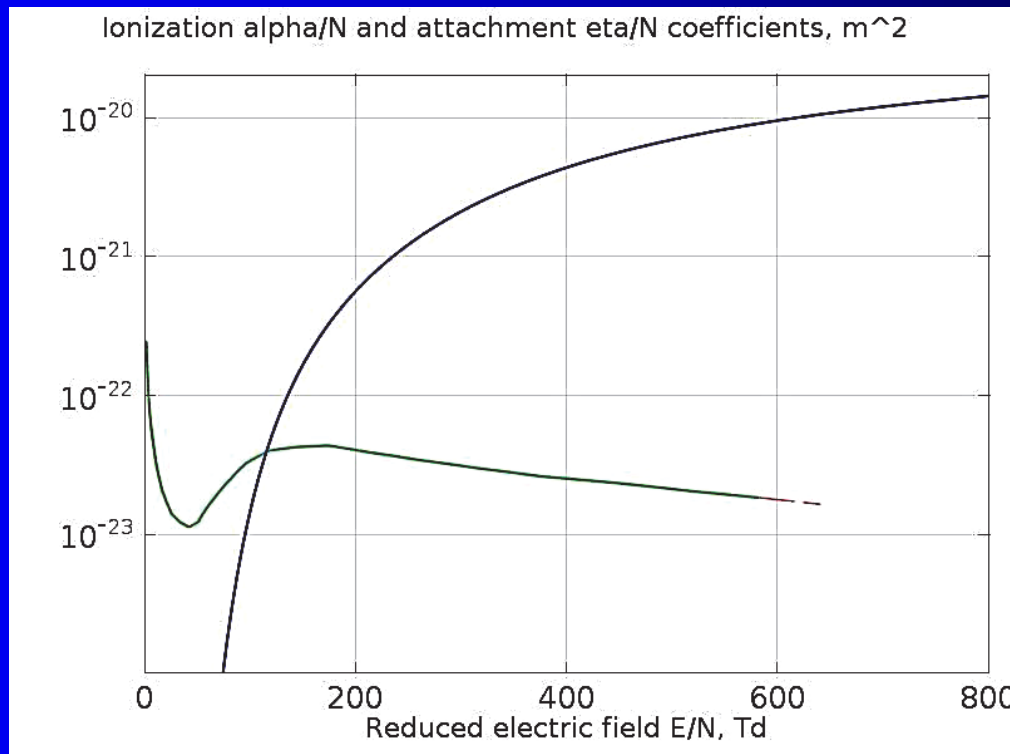

Atom or molecule	Electron affinity (eV)
O	1.461 <sup>*</sup>
O <sub>2</sub>	0.451
O <sub>3</sub>	2.103
NO <sub>2</sub>	2.273
NO	.026
SF <sub>6</sub>	1.05 – 1.5
H	.714

Observe that oxygen molecule is electronegative with an electron affinity of about 0.5 eV.

The electron affinity of SF<sub>6</sub> is 1.0 - 1.5 eV and this large affinity makes this gas a suitable candidate in increasing the breakdown voltage in high voltage equipment.

# Excitation

**Nitrogen** – a special gas. It has an extremely high cross section of vibrational excitation by electron impact. It is a quantum-mechanical phenomena related to the existence of metastable negative ion  $N_2^-$ . This means that the vibrational excitation of molecules is extremely efficient.

*J. Phys. D: Appl. Phys.* 46 (2013) 155205

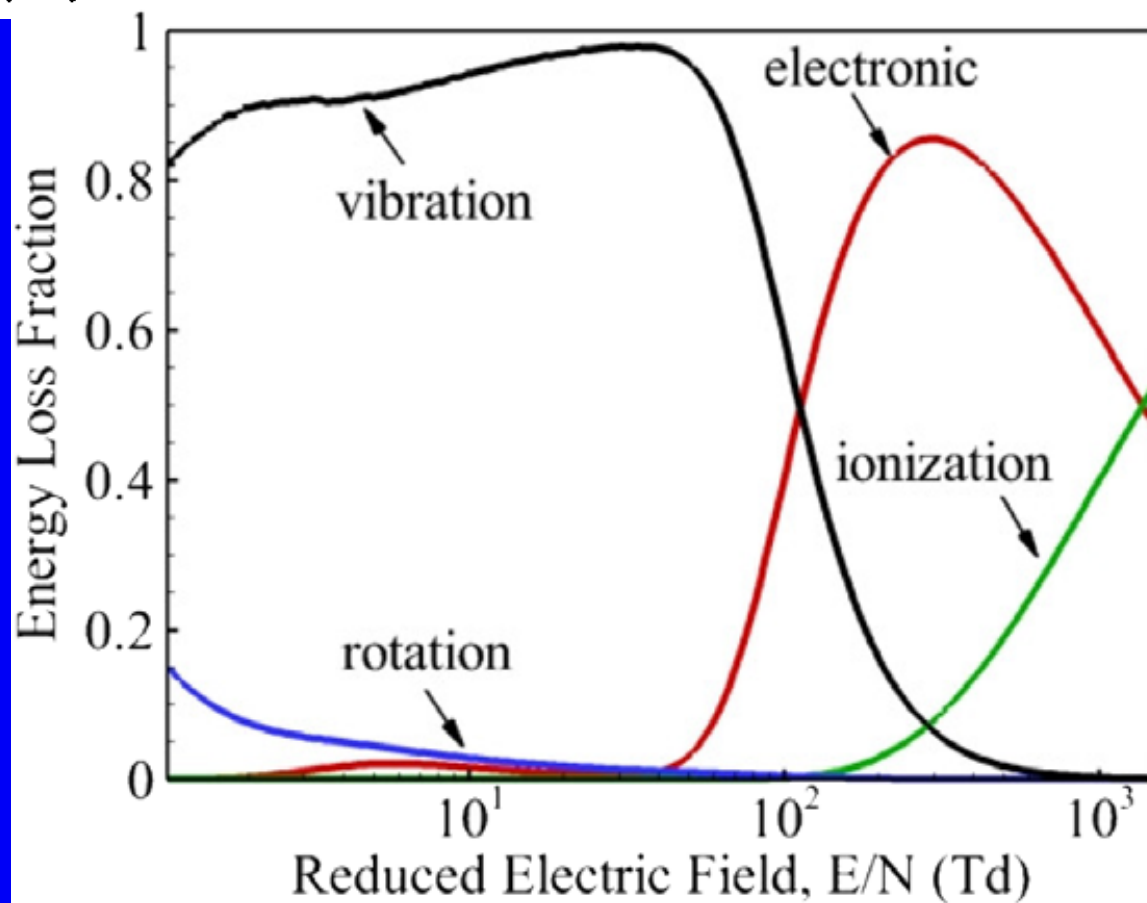

## Applications of non-self-sustained gas discharge

**Example 1: External air ionization by  $\beta$  particles irradiated by Americium 241**





# Smoke detector

(typically 9V and 100 pA)

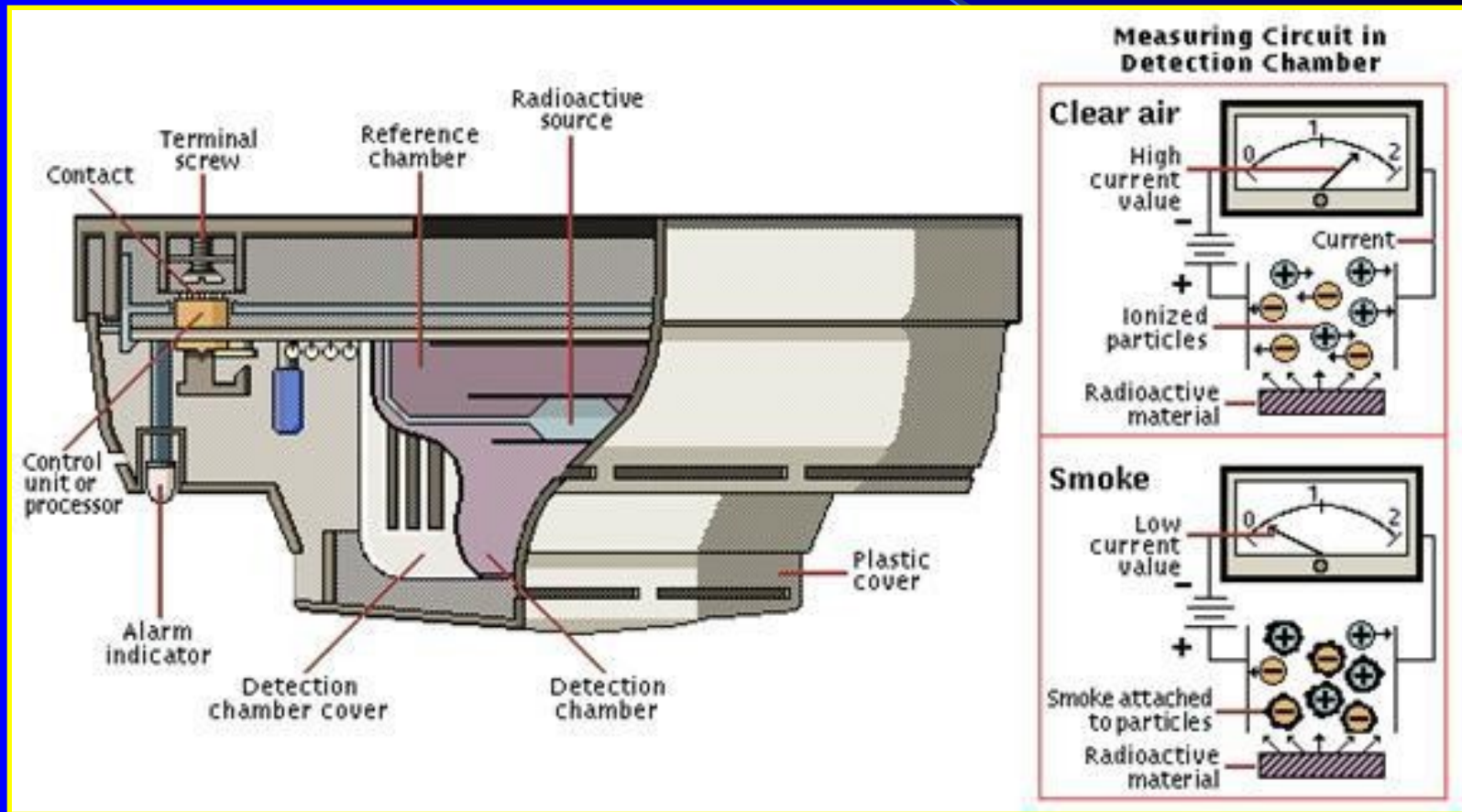

# Gas ionization detectors

## Practical Gaseous Ionisation Detection Regions

This diagram shows the relationship of the gaseous detection regions, using an experimental concept of applying a varying voltage to a cylindrical chamber which is subjected to ionising radiation. Alpha and beta particles are plotted to demonstrate the effect of different ionising energies, but the same principle extends to all forms of ionising radiation.

The ion chamber and proportional regions can operate at atmospheric pressure, and their output varies with radiation energy. However, in practice the Geiger region is operated at a reduced pressure (about  $1/10^{\text{th}}$  of an atmosphere) to allow operation at much lower voltages; otherwise impractically high voltages would be required. The Geiger region output does not differentiate between radiation energies.

Variation of ion pair charge with applied voltage

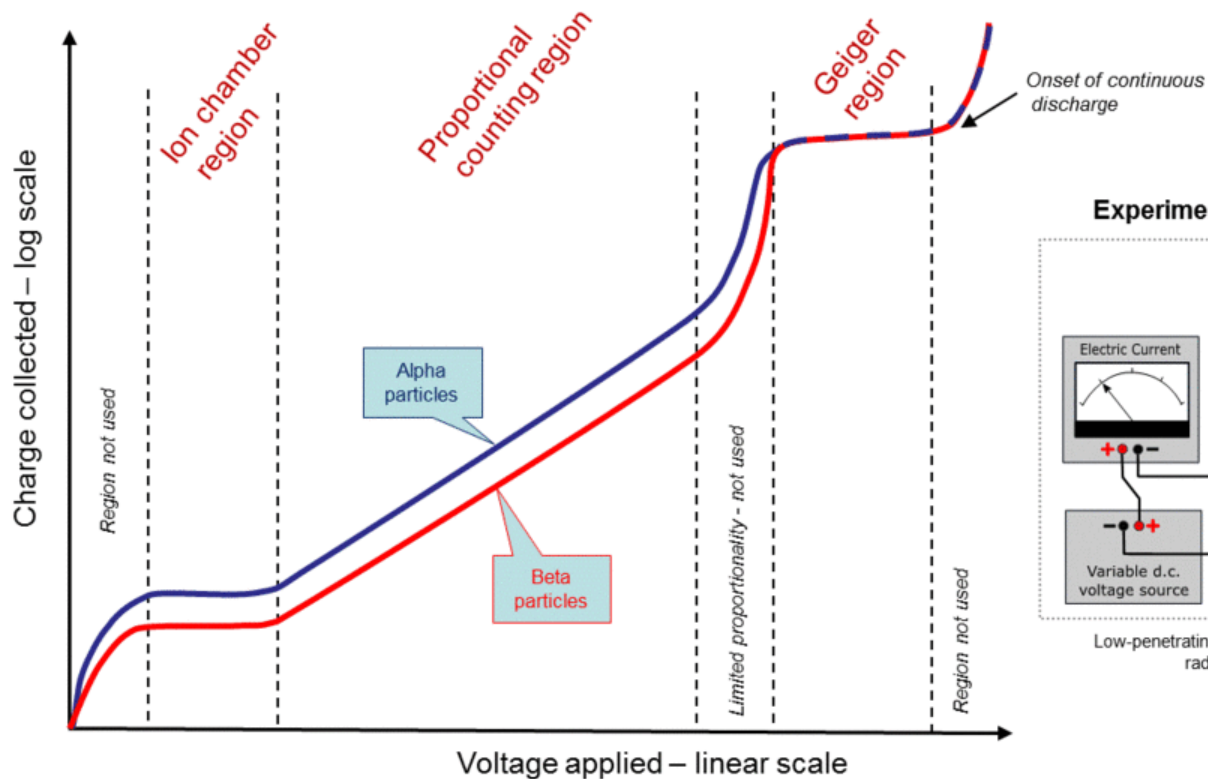

Experimental set-up of a cylindrical chamber

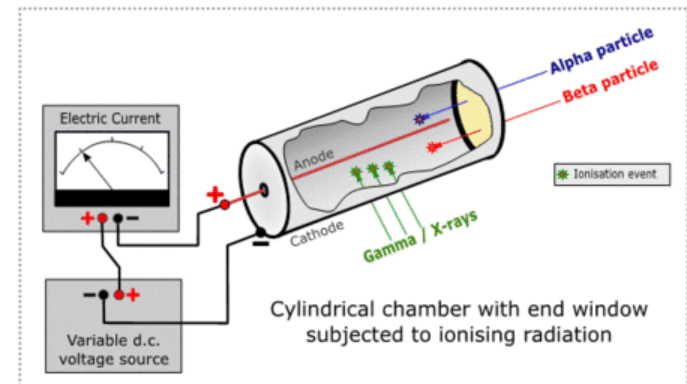

Low-penetrating radiation enters via an end window, but high-penetrating radiation can also enter via the cylinder side wall.

# Proportional detectors

[https://en.wikipedia.org/wiki/Proportional\\_counter](https://en.wikipedia.org/wiki/Proportional_counter)

## Creation of discrete avalanches in a proportional counter

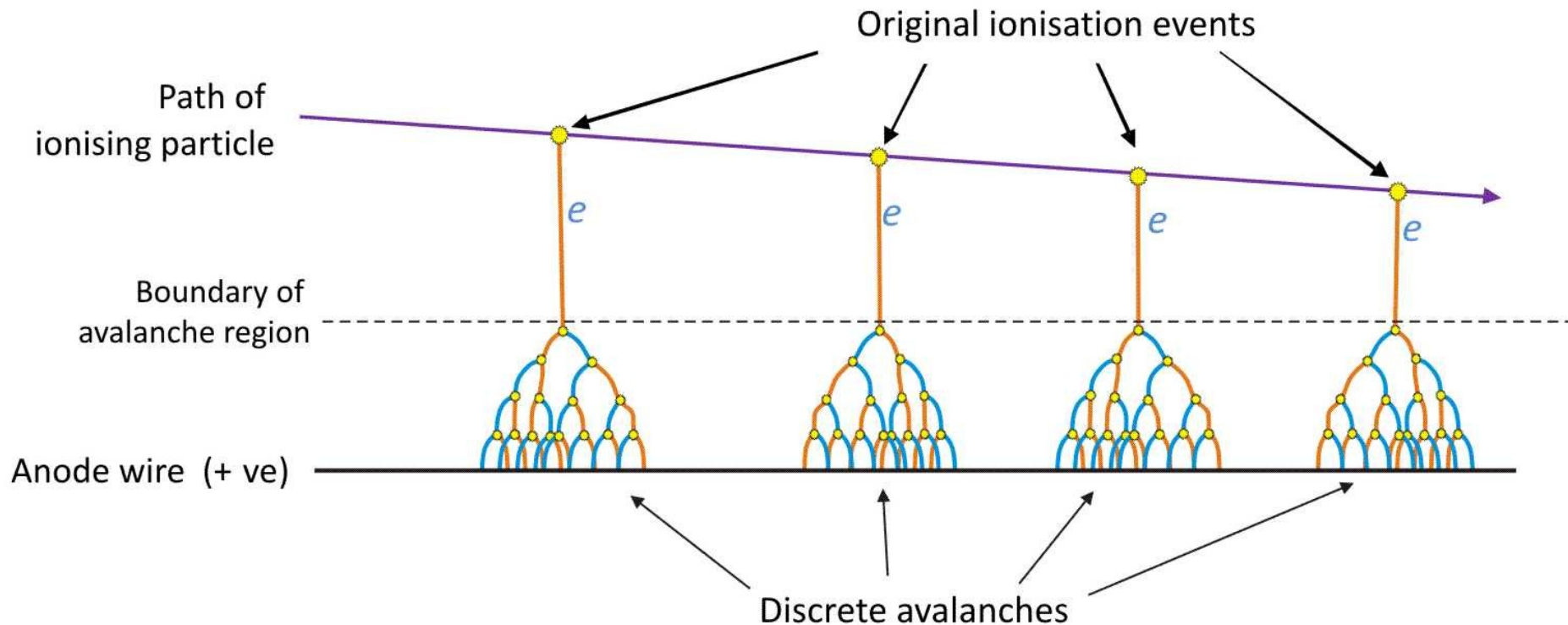

# Multiwire Proportional Counters

**Prof. Charpak**, Nobel prize 1992  
*„Multiwire Proportional Counters“*

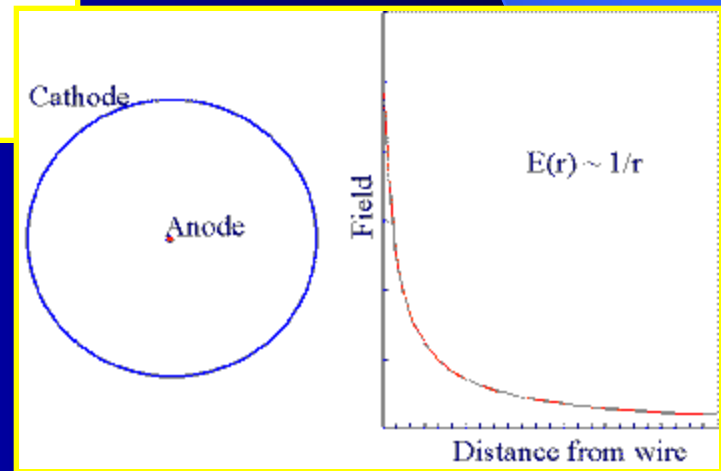
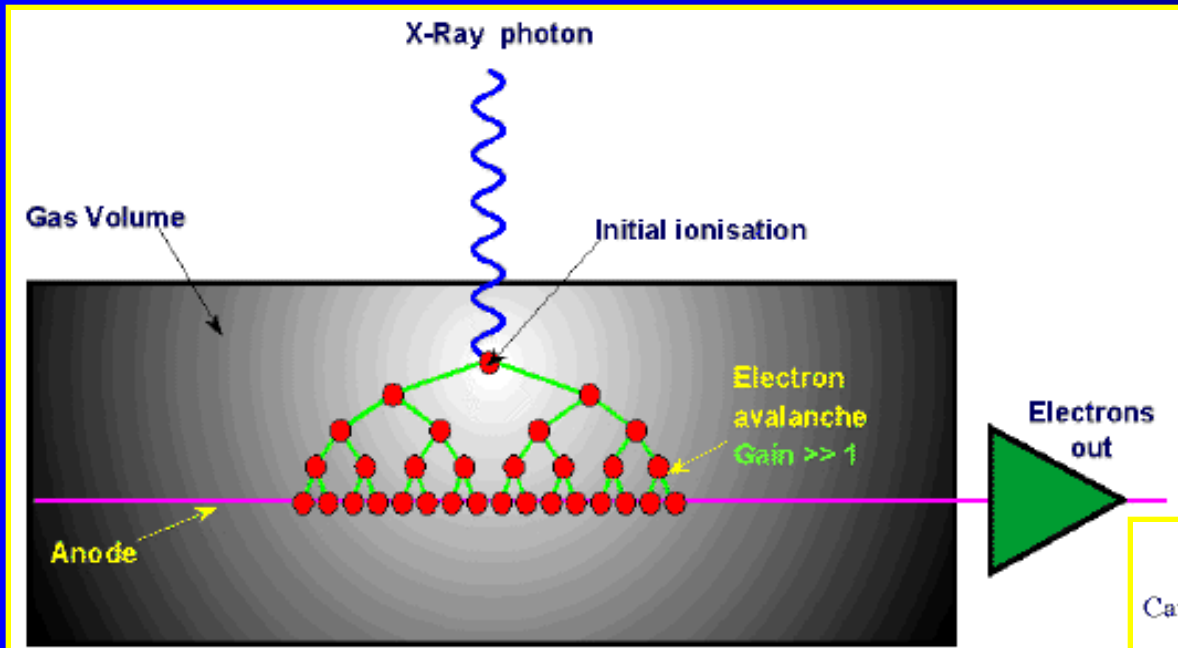
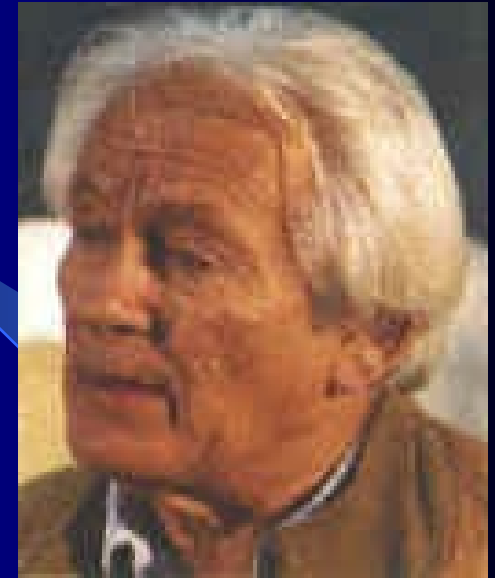

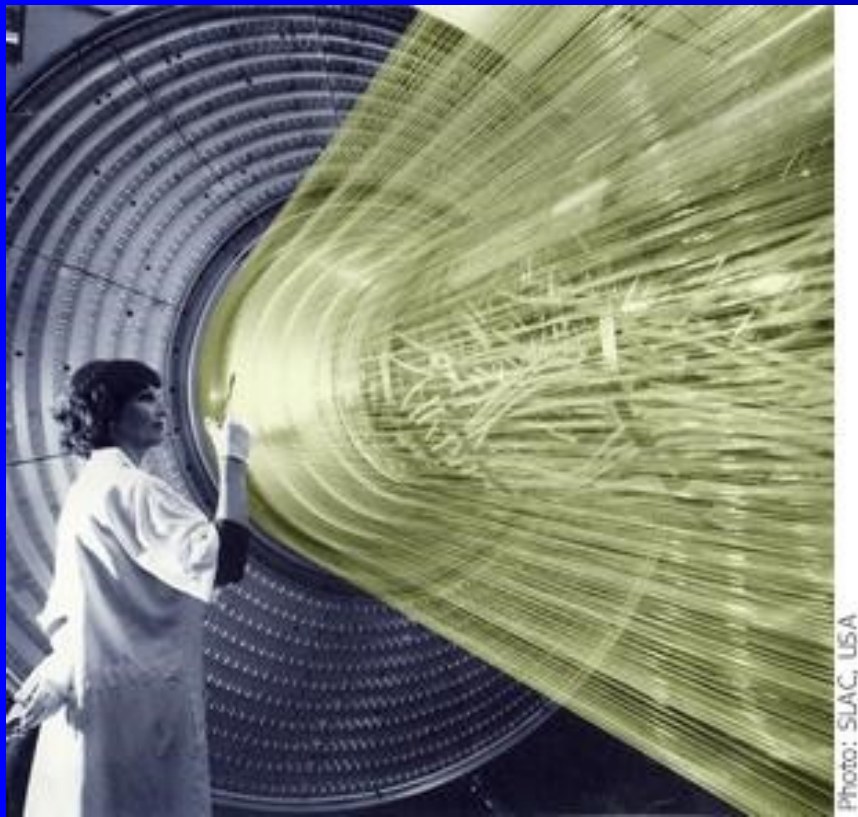
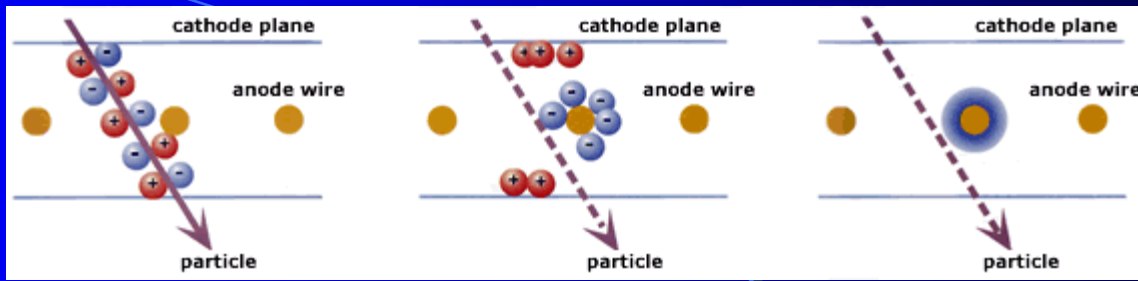
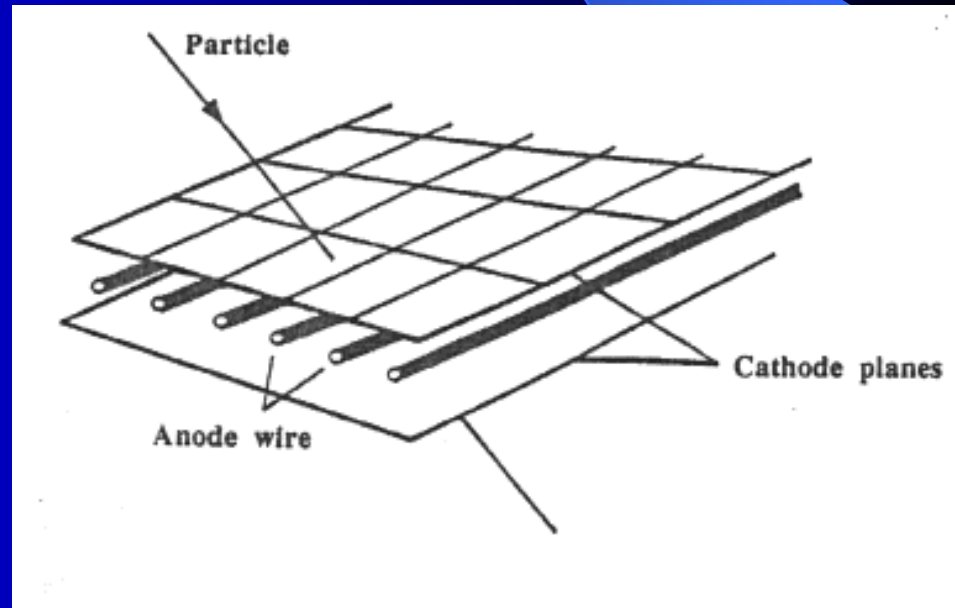

Photo: SLAC, USA





The discovery of the W and the Z particles was rewarded with the Nobel Prize in Physics in 1984 ([Carlo Rubbia and Simon van der Meer](#), CERN). The particle collision in which the Z particle is created and then rapidly decays into an electron and its antiparticle, the positron, can be seen in the middle of the picture. The tracks of all the charged particles are detected in the central drift chamber. The Z particle is only created in one particle collision in a thousand million.

# Geiger- Muller tube

## Spread of avalanches in a Geiger-Muller tube

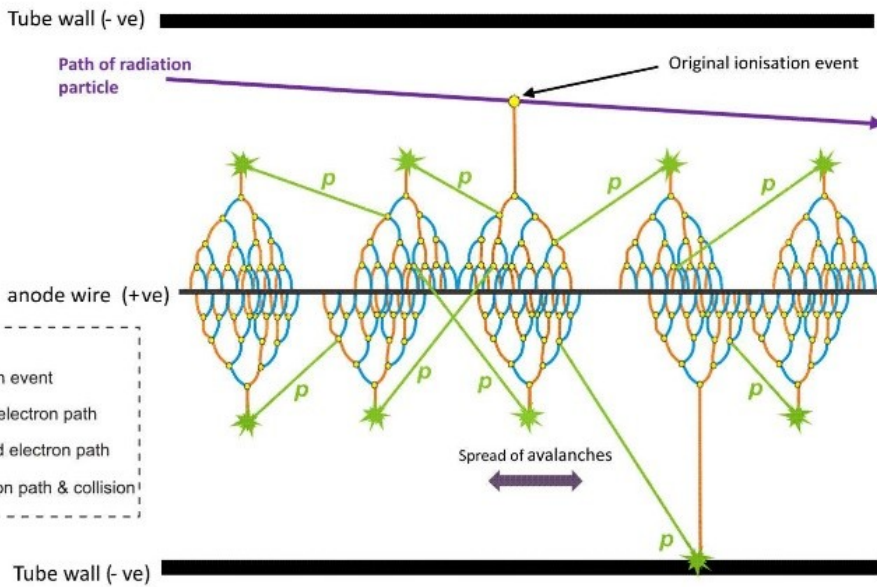

Not to scale

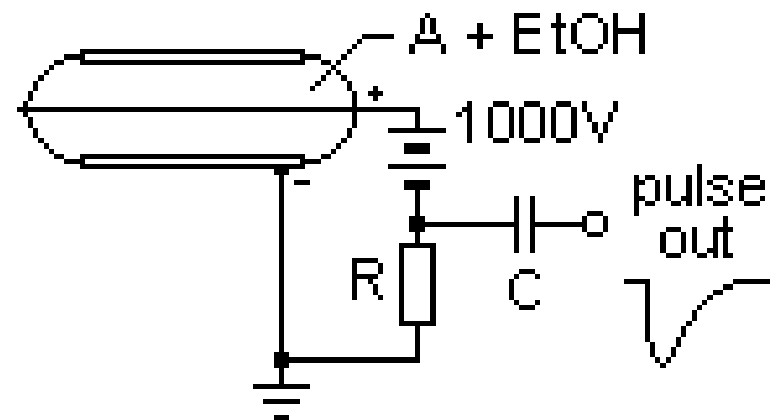

### Geiger-Müller Tube

# Avalanche transistors very fast HV switching

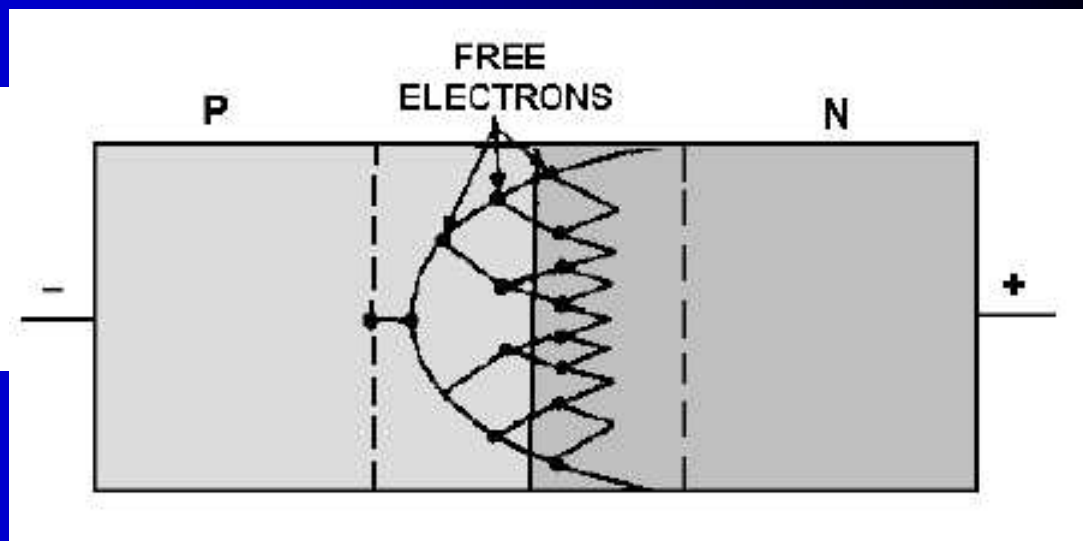

## •Photonics Research 9(2021) 370-378

There is still a lack of high-performance **terahertz (THz) modulators** with wide operation bandwidth and large modulation depth due to the underlying physics limitation behind existing approaches. Meanwhile, for many applications, simple compact THz modulators working straightforward in the transmission mode are also highly desired. Here, we demonstrate a THz modulator with a maximal transmission-amplitude modulation depth of 99.9% (switching ratio of 1000) based on a commonly used silica-on-silicon structure. Different from those reported graphene or metamaterials enhanced proposals, the device we proposed works within a reversible avalanche breakdown region of silicon that has not been studied yet and has the potential to modulate/switch THz waves efficiently. Further, we proved that the modulation depth exceeds 97% in the frequency range from 0.2 to 1 THz in the experiment. The simplicity and generality of this new type of near-perfect THz modulator will undoubtedly attract lots of attention of researchers in the near future due to its potential to be engineered into integrated devices.



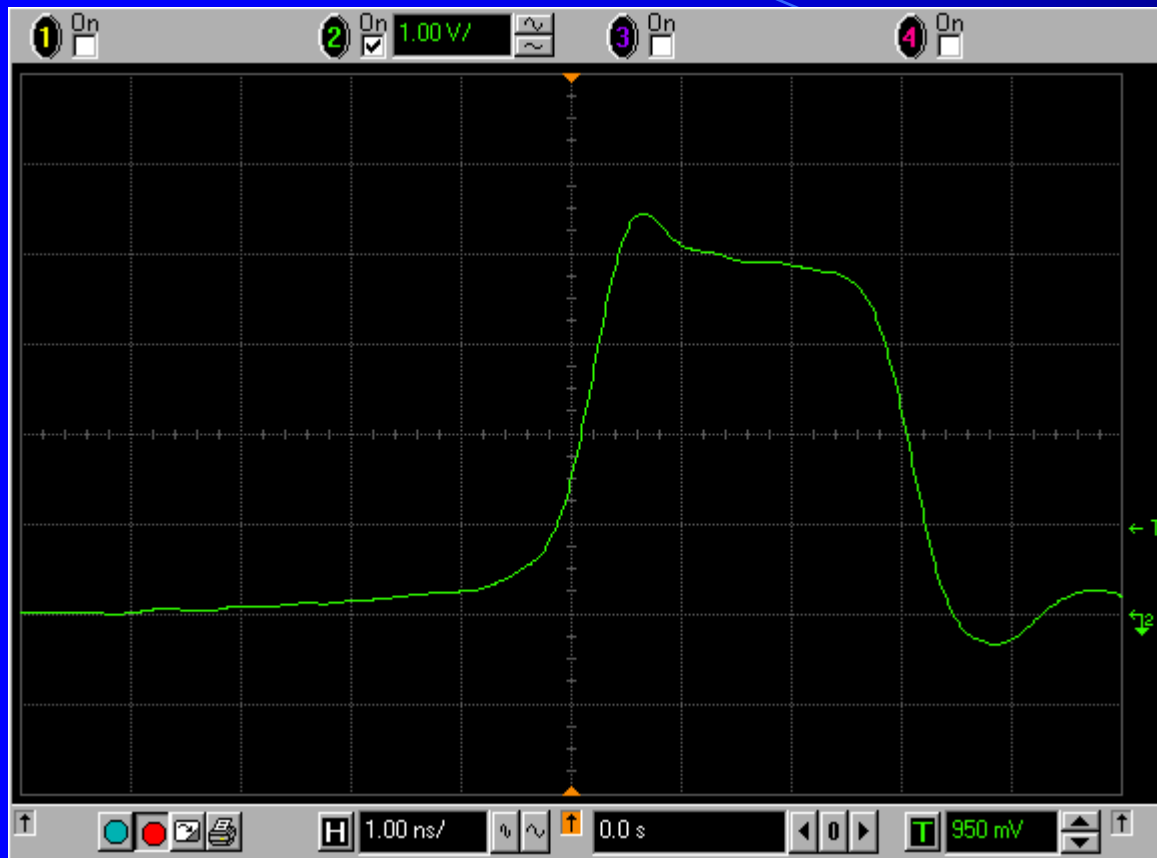

Rev. Sci. Instrum. 87, 054708 (2016); doi: 10.1063/1.4948727  
„High-voltage pulse with **leading edge about 200 ps and amplitude about 2 kV** has been output by the designed circuit“.