

# STREAMER DISCHARGE MECHANISM

**Townsend discharge mechanism** requires the secondary electron emission from the cathode due to the arrival of positive ions created in the anode vicinity (in many gases, for example, Ar,  $N_2 + CH_4$  a fast photoemission is absent) and drifting through 1 mm – 1 cm interelectrode gap with the velocity of some  $\sim 10^5 - 10^6$  cm/s

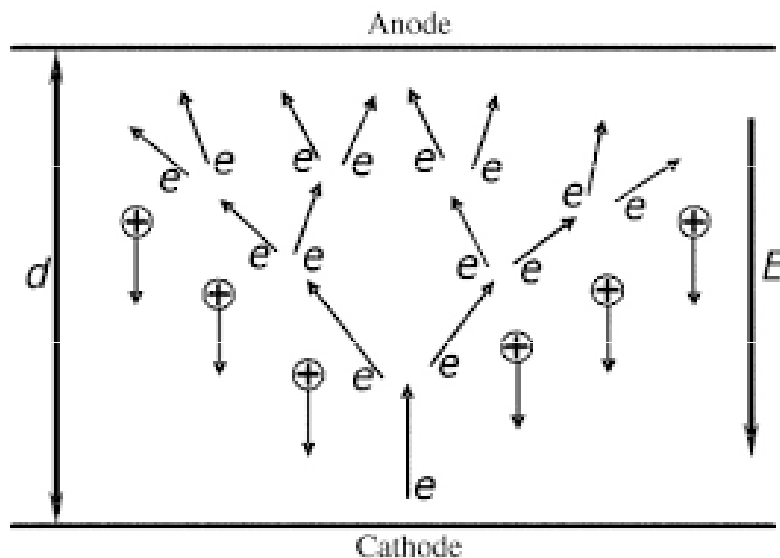

Can be the arc or spark discharge („el. breakdown“) formed in some **1– 100 ns** ?

**YES !** – because of the formation of fast ionization waves, the so-called **streamers**. The streamers are generated at higher overvoltages and pressures (say above 10% of atm. tlaku)

# Townsend vs. streamer mechanism

Pressure ( $p$ ), interelectrode distance ( $d$ ) and overvoltage  $K_{\text{over}} = (U - U_s)/U_s$ , where  $U_s$  is the static onset voltage according to the Paschen curve. The  $p$  and  $K_{\text{over}}$  determine the discharge mechanism:

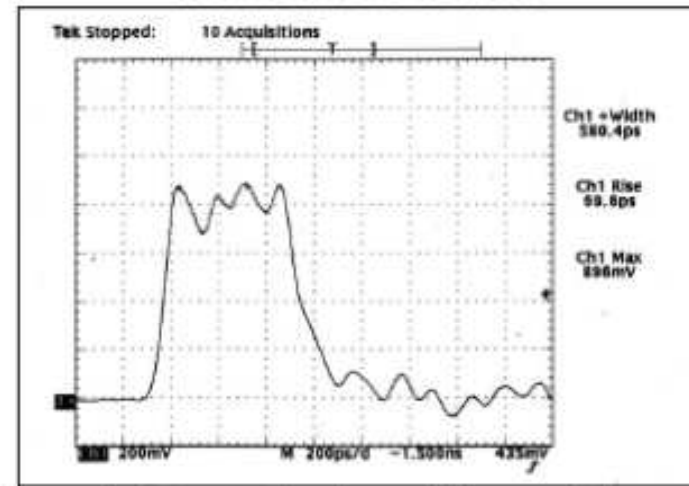
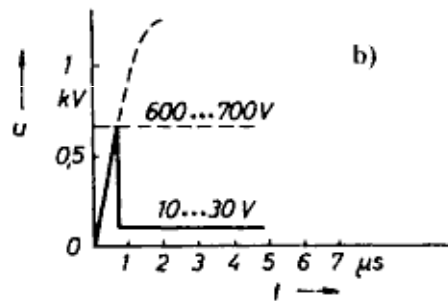
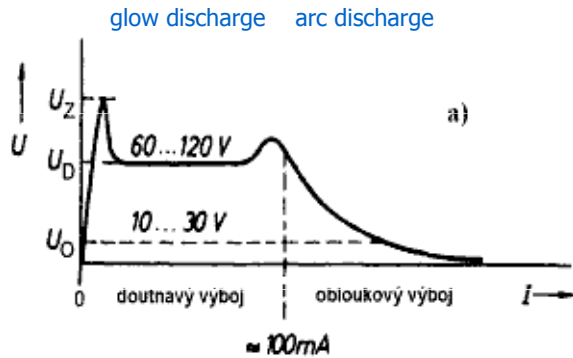
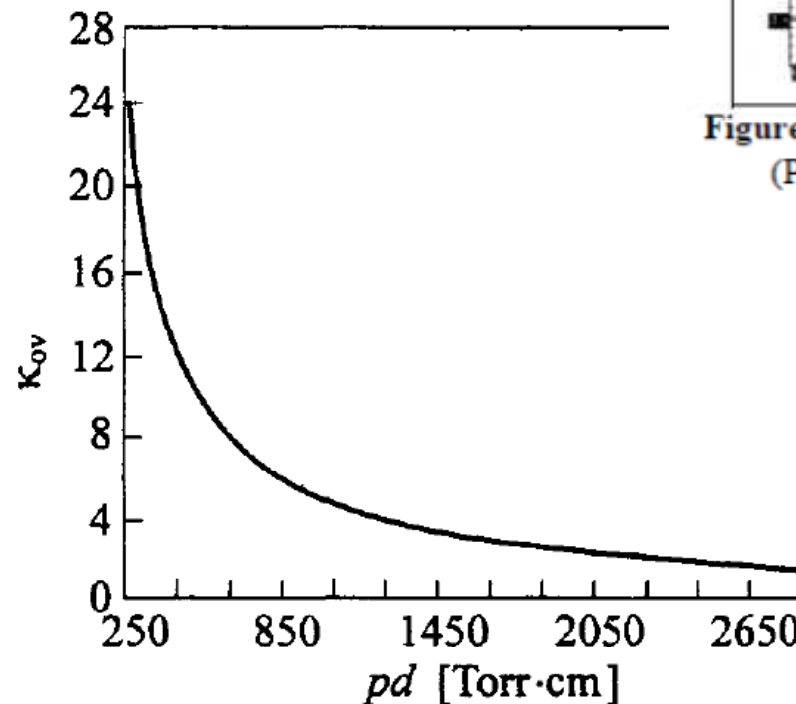

Figure 6. Output pulse shape of the coaxial generator ( $P=55 \text{ bar}$ ,  $d=0.45 \text{ mm}$ ,  $\tau=68 \text{ ps}$ ,  $V_{\text{OUT}}=26 \text{ kV}$ )

Townsend mechanism



Streamer mechanism



# Ultrafast spark gap for sub-nanosecond HV switching for special radars

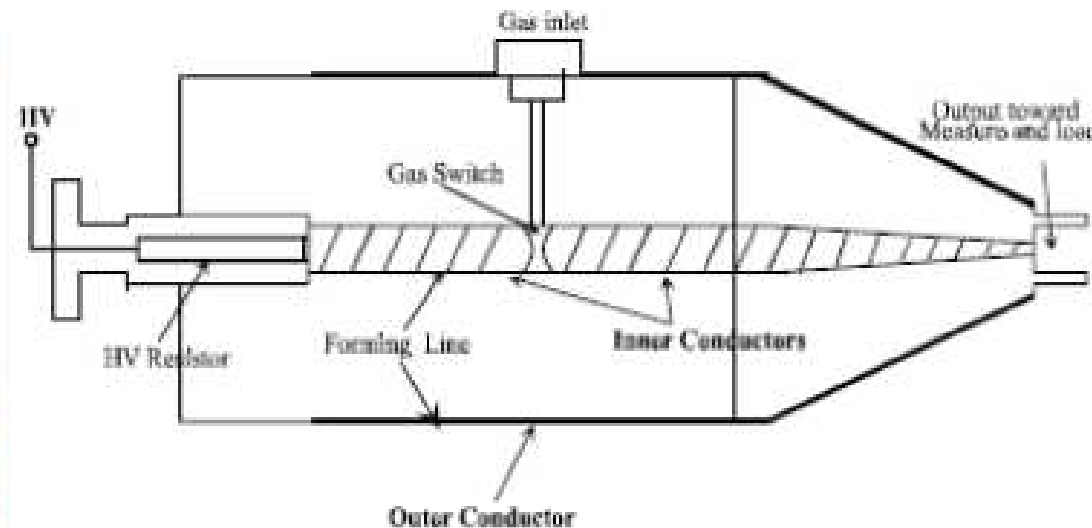
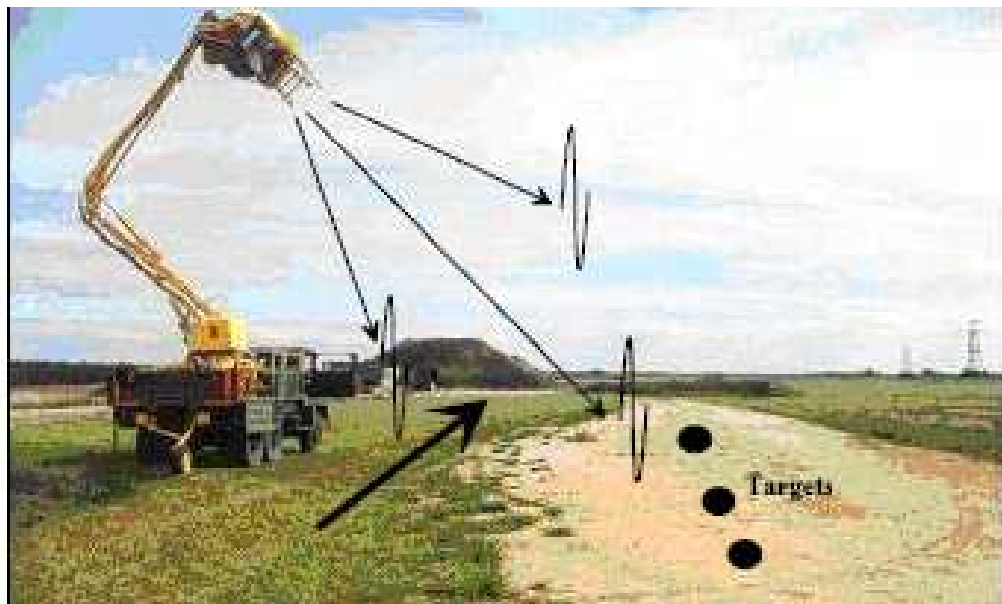

Hydrogen spark gap pressurized up to 55 atm. :

$$d/T = 0.45 \text{ mm} / 68 \times 10^{-12} \text{ s} = 7 \times 10^8 \text{ cm/s}$$

Ion velocity  $\sim 10^5 \text{ cm/s}$

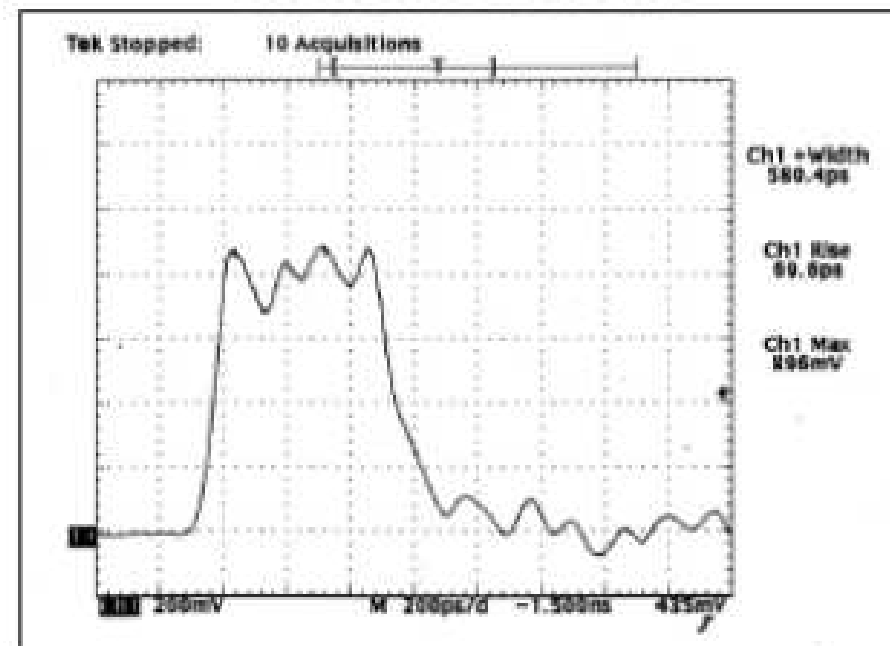
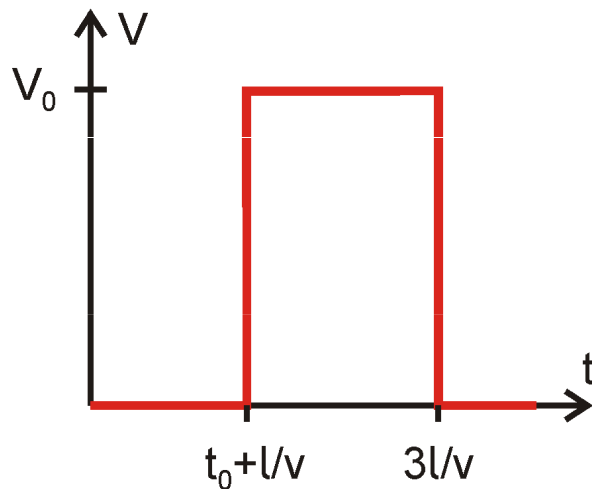
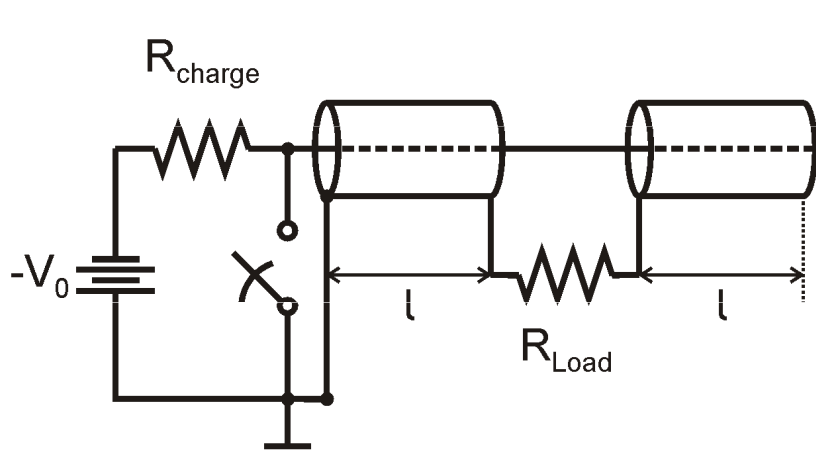

Figure 6. Output pulse shape of the coaxial gas switch (P=55bar, d=0.45mm,  $\tau=68\text{ps}$ ,  $V_{OUT}=26\text{kV}$ )

# Formation of narrow HV pulses using coaxial Blumlein forming line

[http://pulsedpower.de/pulsedpower\\_engineering.html](http://pulsedpower.de/pulsedpower_engineering.html)



(A speed of the wave propagation in coax lines is about two-thirds the light speed => 1m thin coax delays ~5ns)

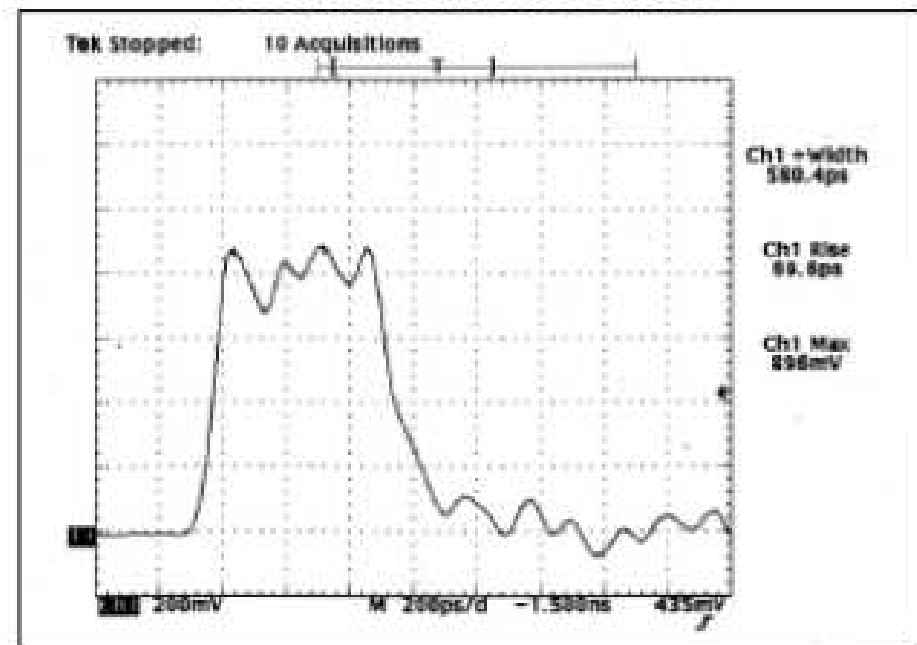
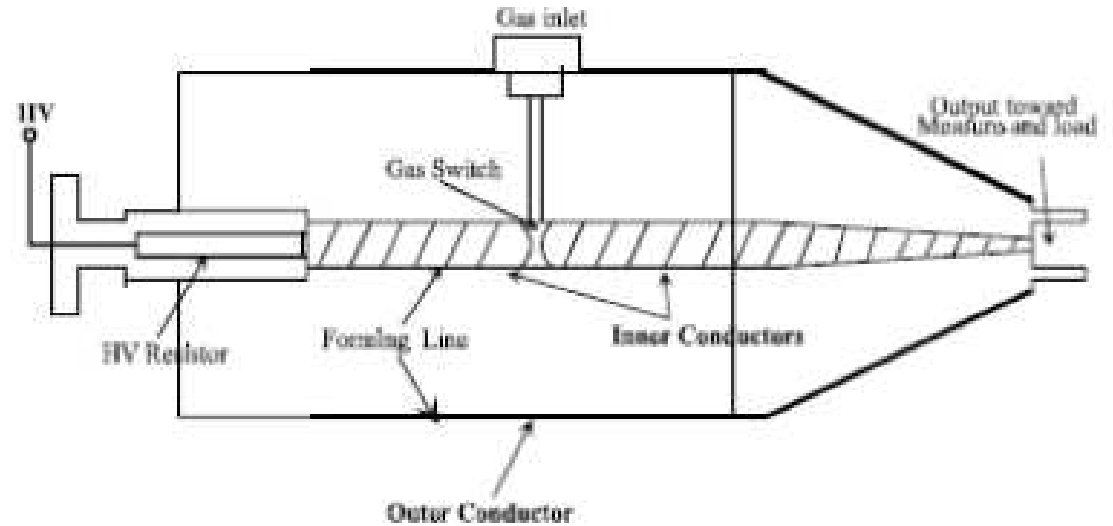
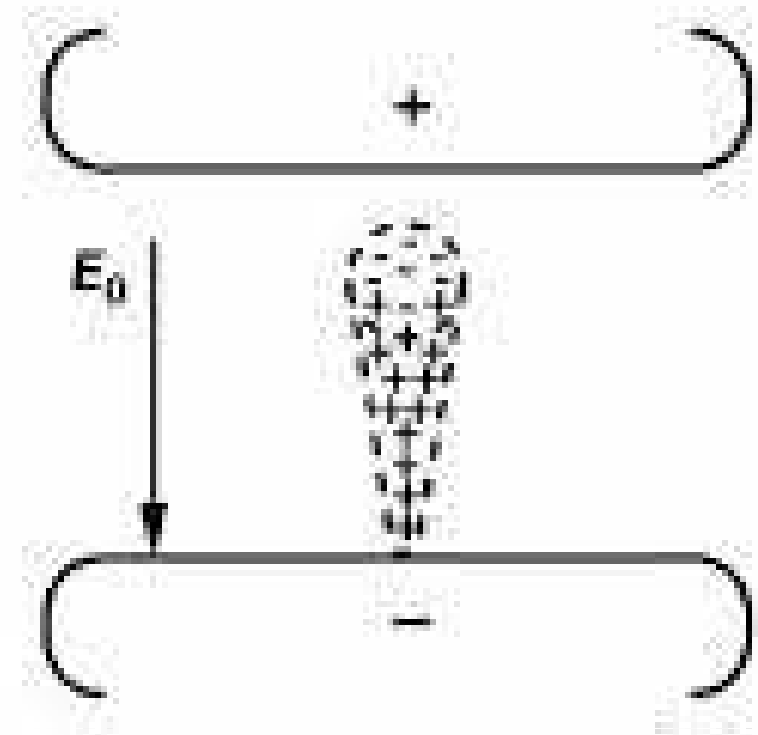
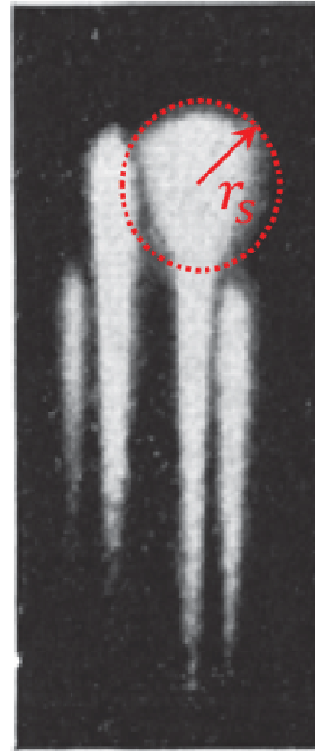
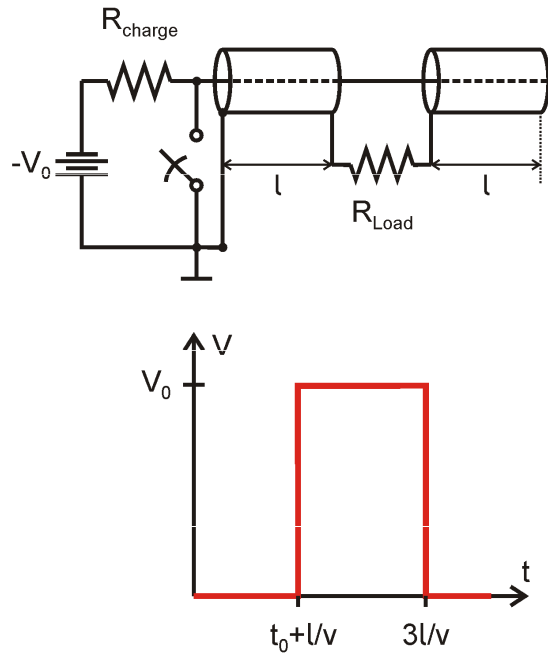

Figure 6. Output pulse shape of the coaxial generator (P=55bar, d=0.45mm,  $\tau=68\text{ps}$ ,  $V_{\text{OUT}}=26\text{kV}$ )

In the beginning of 20th century the visualization of electron avalanches was possible using the Wilson's cloud chamber, a standard camera, and the HV pulse forming line:



(c)

Cloud chamber photograph showing the transition from avalanches into streamers where the initial radius of the streamer initiating plasma is marked (c), from H. Raether, Electron avalanches and breakdown in gases. Washington, D.C.: Butterworth Inc., 1964.

To avoid of the delay in the avalanche onset (*statistics of the discharge onset*) such were made at very high overvoltages !

With the increasing the avalanche size, its velocity is decreasing due to effect of Positive ions generated by the avalanche itself. At the so-called critical size  $N_{crit} = 10^8$  the avalanche movement is stopped since the el. field generated by the avalanche itself compensated the external Laplacian el. field. The resultant el. field in the avalanche head is close to zero, which means that a region of el. conductive el. plasma („streamer initiating plasma“) is generated. The streamer is initiated to to the significant el. field increase resulting in a dramatic ionization increase at the electrodes-facing plasma surfaces.

Therefore, **the single-avalanche Reather's criterion for the streamer formation is**

$$\exp(\alpha \cdot d) \geq 10^8$$

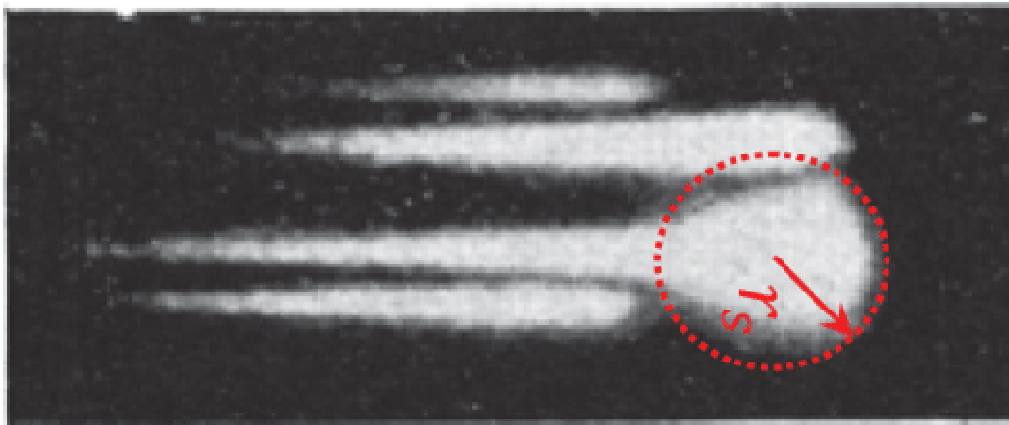

**Figure: The avalanche recorded at the moment of reaching The so-called critical size of  $10^8$  electrons and the avalanche head was a transformed into a plasma region with the radius  $r_c$**

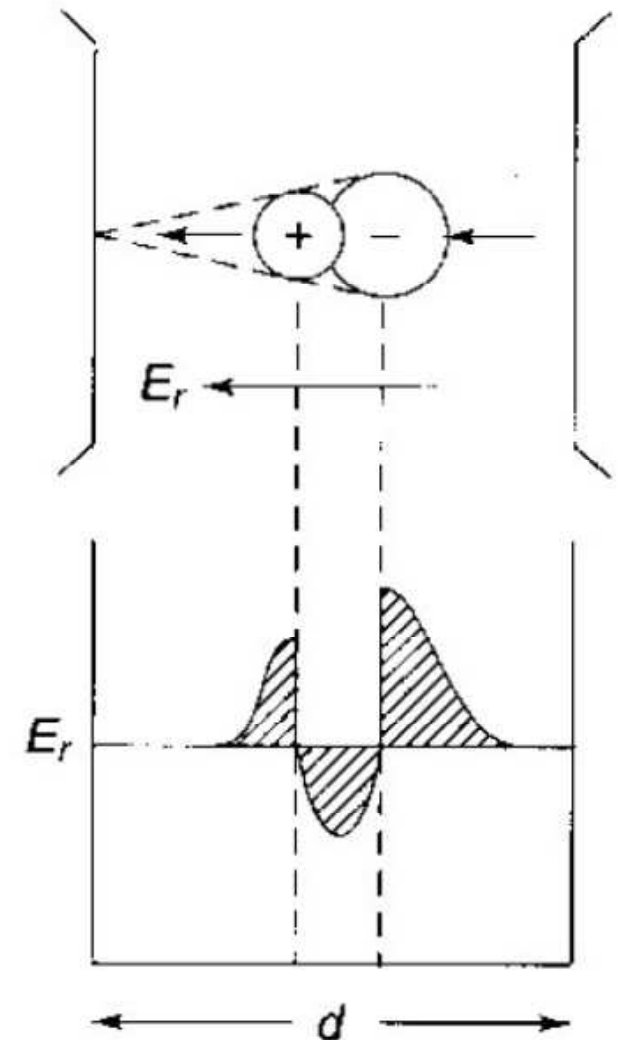

## Raether's (Raether – Meek's) criterion

Lets consider that all electrons in the avalanche head are concentrated at the distance  $x$  from the cathode inside of the spherical region with the radius  $r$ .

Then the el. field on the region surface is

$$E_r = \frac{ee^{\alpha x}}{4\pi\epsilon_0 r^2}$$

The avalanche head radius  $r$  resulting from the electron diffusion is given by

( $D$  is the diffusion coefficient) :

$$r \approx \sqrt{3Dt}$$

The duration of the avalanche can be computed

The electron drift velocity

( $v_d$  is the drift. velocity,  $k_e$  is the electom mobility)

$$t = \frac{x}{v_d} = \frac{x}{k_e E}$$

so that:

$$r = \sqrt{\frac{3Dx}{k_e E}}$$

and consequently:

$$E_r = \frac{ee^{\alpha x}}{4\pi\epsilon_0 [3Dx / (k_e E)]}$$

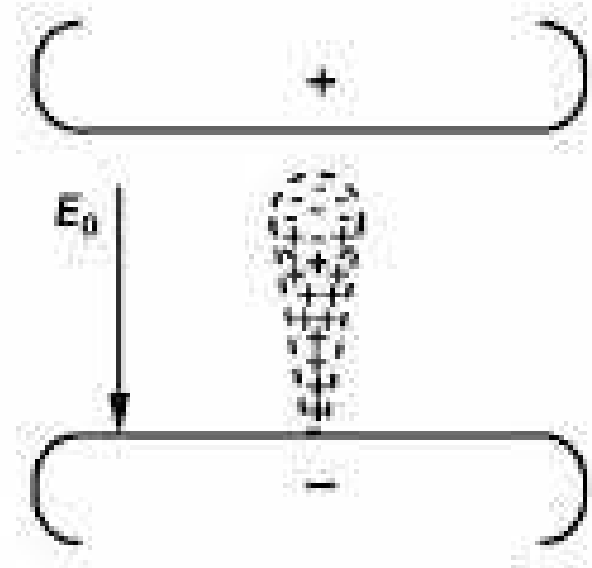

The avalanche propagation is stopped and **the plasma is formed** when  $E_r \approx E$ .

Using known values of  $D$ ,  $k_e$  and  $E$  (on the order of 10 – 100 kV/cm) using the derived equation

$$E_r = \frac{ee^{\alpha x}}{4\pi\epsilon_0 [3Dx / (k_e E)]}$$

we obtain

$$\exp(\alpha x) \geq 10^8$$

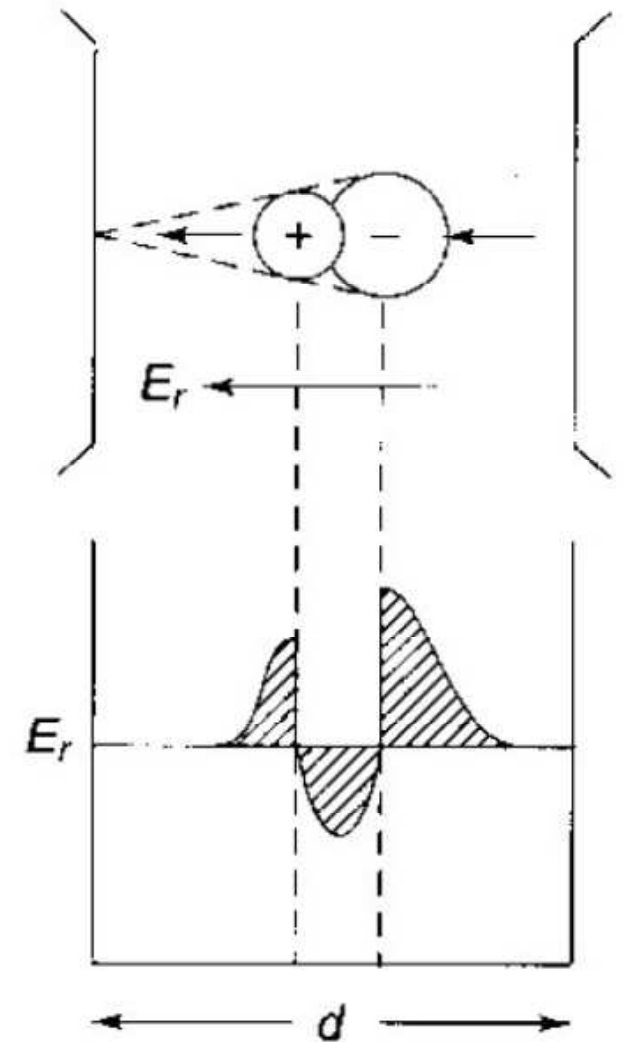
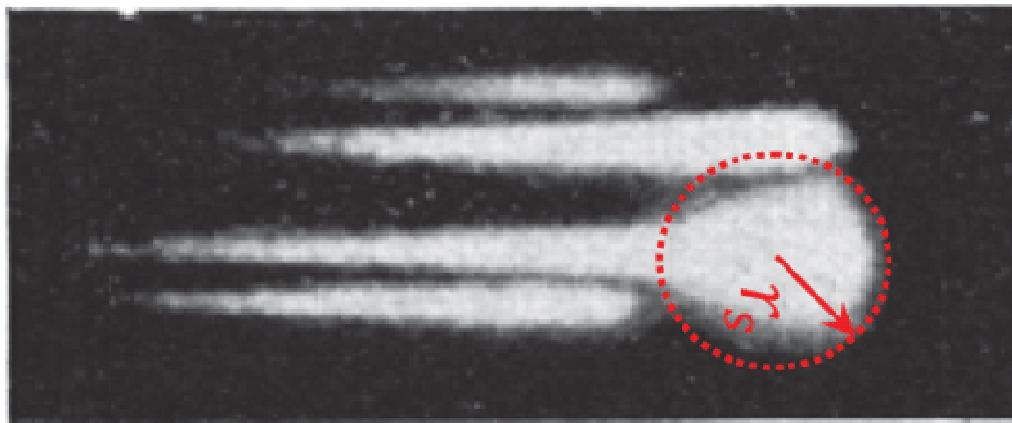



# Electron Avalanche

At high pressures/voltages plasma forms due to single electron avalanche event

Charge separation due to slower moving ions

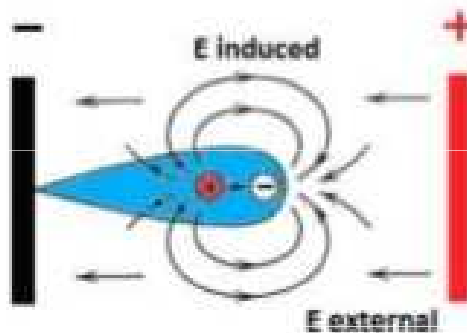

Avalanche produces induced electric field

$$E_{\text{induced}} = E_{\text{applied}}$$

Image from Raizer, Y., *Gas Discharge Physics*, 1987.

Avalanche transitions to thin filamentary plasma called a **streamer**

Streamer Head  
(~Debye length)

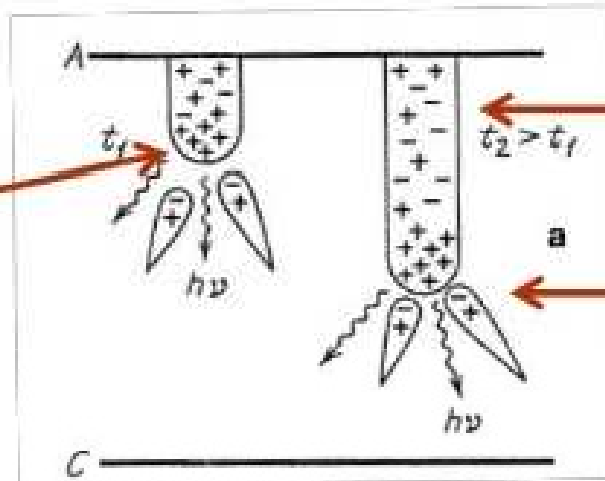

"Shielded"  
Low E-field

"Enhanced"  
High E-field

At a relatively low el. field,  $e^{ad} \sim 10^8$  the streamer is generated in the immediate vicinity of the anode and will start to propagate towards the cathode as **the positive (cathode directed) streamer**

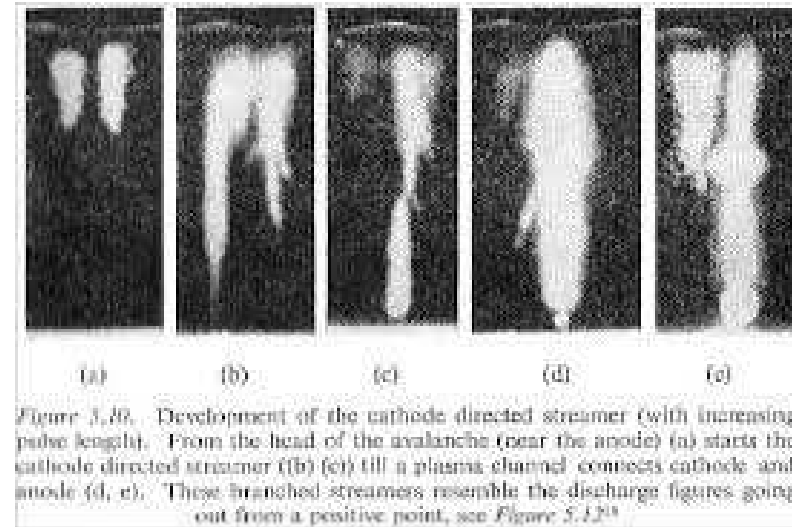
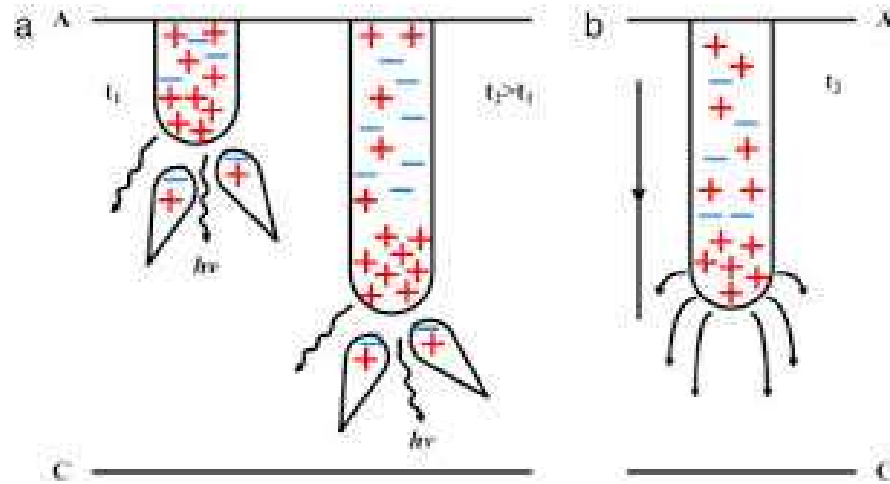

At the higher fields when  $e^{ad} > 10^8$ , the streamer initiating plasma is generated  $X_{cr} < d$  and both the cathode-directed (positive) and the anode directed (negative) streamer will start:

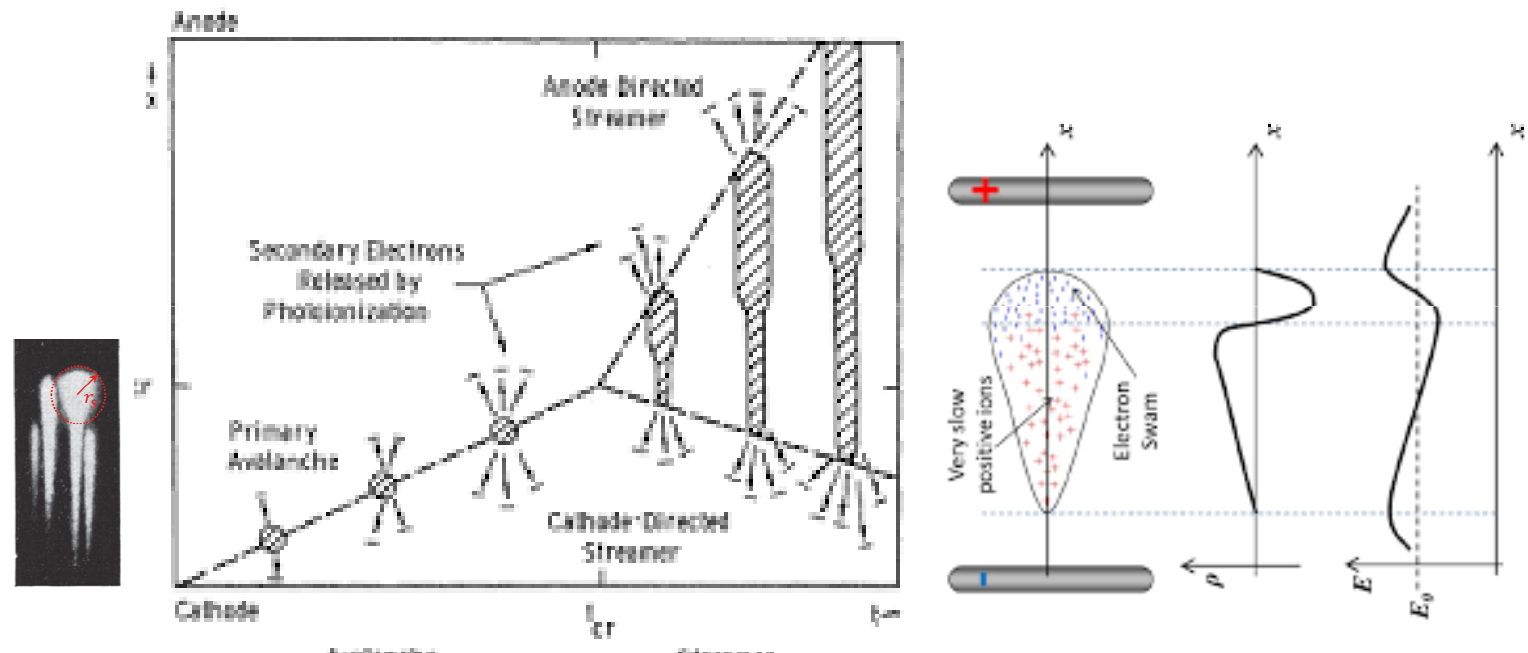

The **anode-directed (negative) streamer** propagates in the direction of the drift of fast electrons and usually is not important for the subsequent discharge. **The positive streamer** is very important for the subsequent discharge development since at its arrival to the cathode it **creates the cathode spot similar to the cathode region of a glow discharge**. Such cathode spot can be very quickly be transferred in a „hot“ cathode spot of an arc discharge

**The positive streamer head** propagates in the direction opposite to the drift of fast electrons with the speed on the order of  **$10^8$  cm/s**. It can be understood as the phase movement of the point of the maximum el. el. field strenght. „**Seed electrons**“ initiating the avalanches in the streamer head vicinity are generated by photoionization. (The drift of positive ions can be neglected on the considered time scale !)

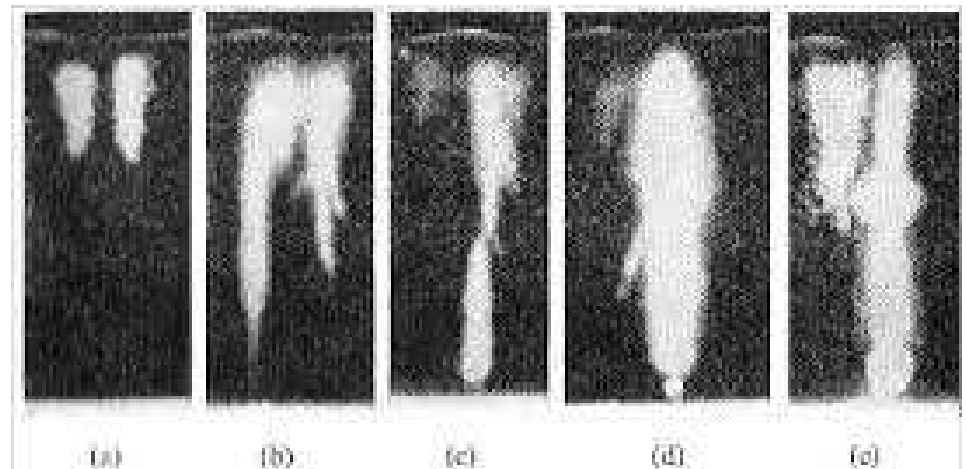
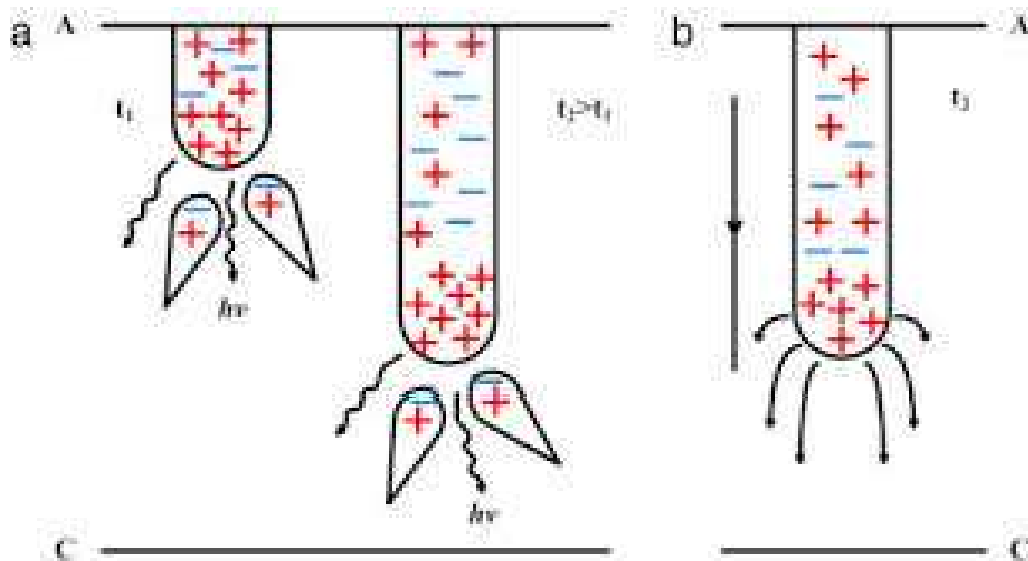
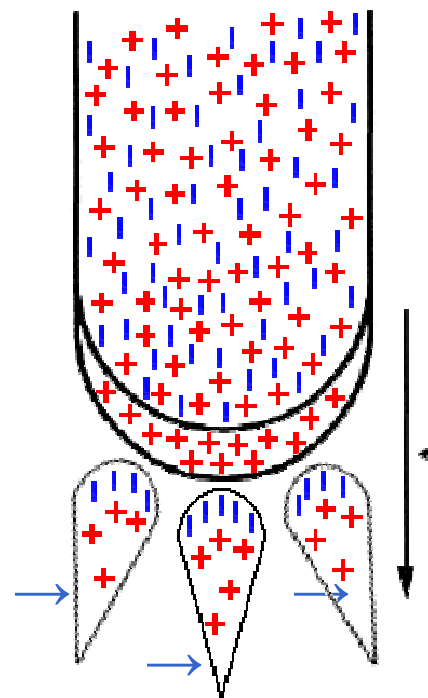
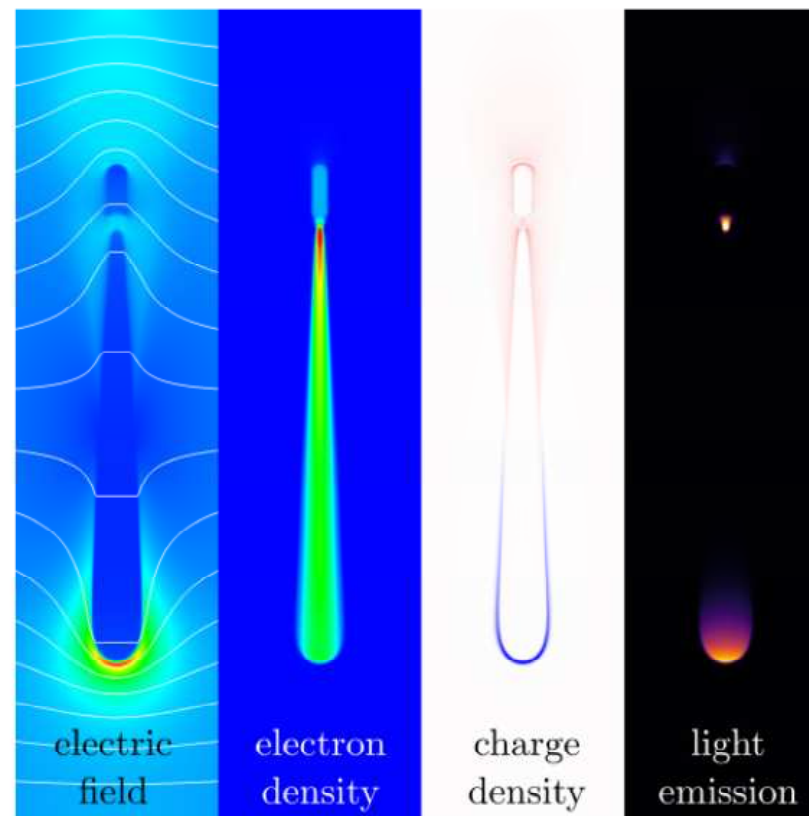

Figure 3.10. Development of the cathode directed streamer (with increasing pulse length). From the head of the avalanche (near the anode) (a) starts the cathode directed streamer (b) (c) till a plasma channel connects cathode and anode (d, e). These branched streamers resemble the discharge figures going out from a positive point, see Figure 3.12<sup>13</sup>



„seed electrons“  
Generated by the  
photoionization



**Figure 3.** Simulation example showing a cross section of a positive streamer propagating downwards. A strong electric field is present at the streamer tip. A charge layer surrounds the streamer channel, with both positive charge (blue) and negative charge (red) present. A cross section of the instantaneous light emission is also shown, which is concentrated near the streamer head. The simulation was performed with an axisymmetric fluid model [22] in air at 1 bar, in a gap of 1.6 cm with an applied voltage of 32 kV.

Jannis Teunissen and Ute Ebert. Simulating streamer discharges in 3D with the parallel adaptive Afivo framework. *J. Phys. D: Appl. Phys.*, 50(47):474001, October 2017.

# Propagation of positive streamers

- Propagate against electron drift direction
- Free electrons required in front of streamer
  - Photo-ionization (air)
  - Background ionization
    - Natural
    - Leftover from previous discharges
    - Artificial radioactivity
    - .....
- Electrons mostly attached to oxygen ( $O_2^-$ )

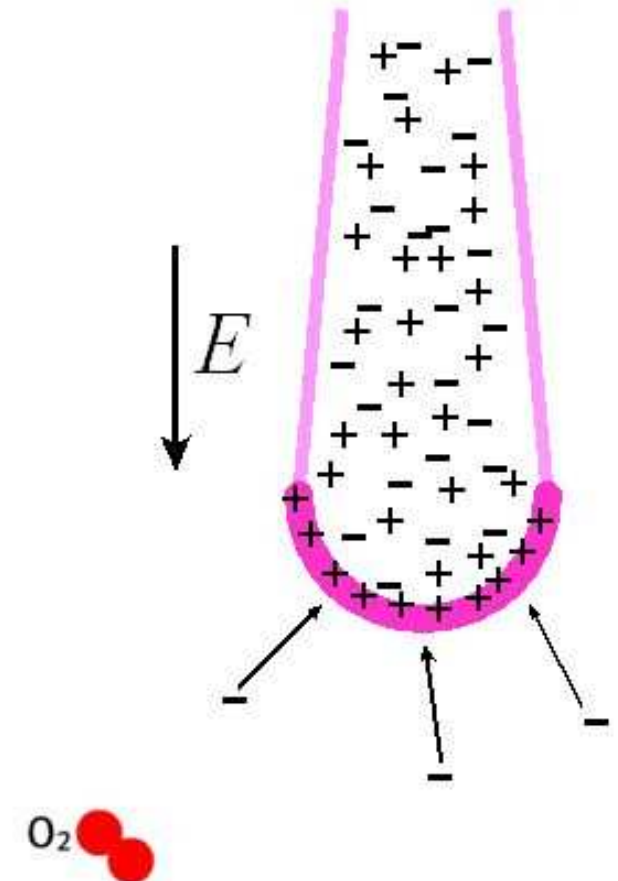
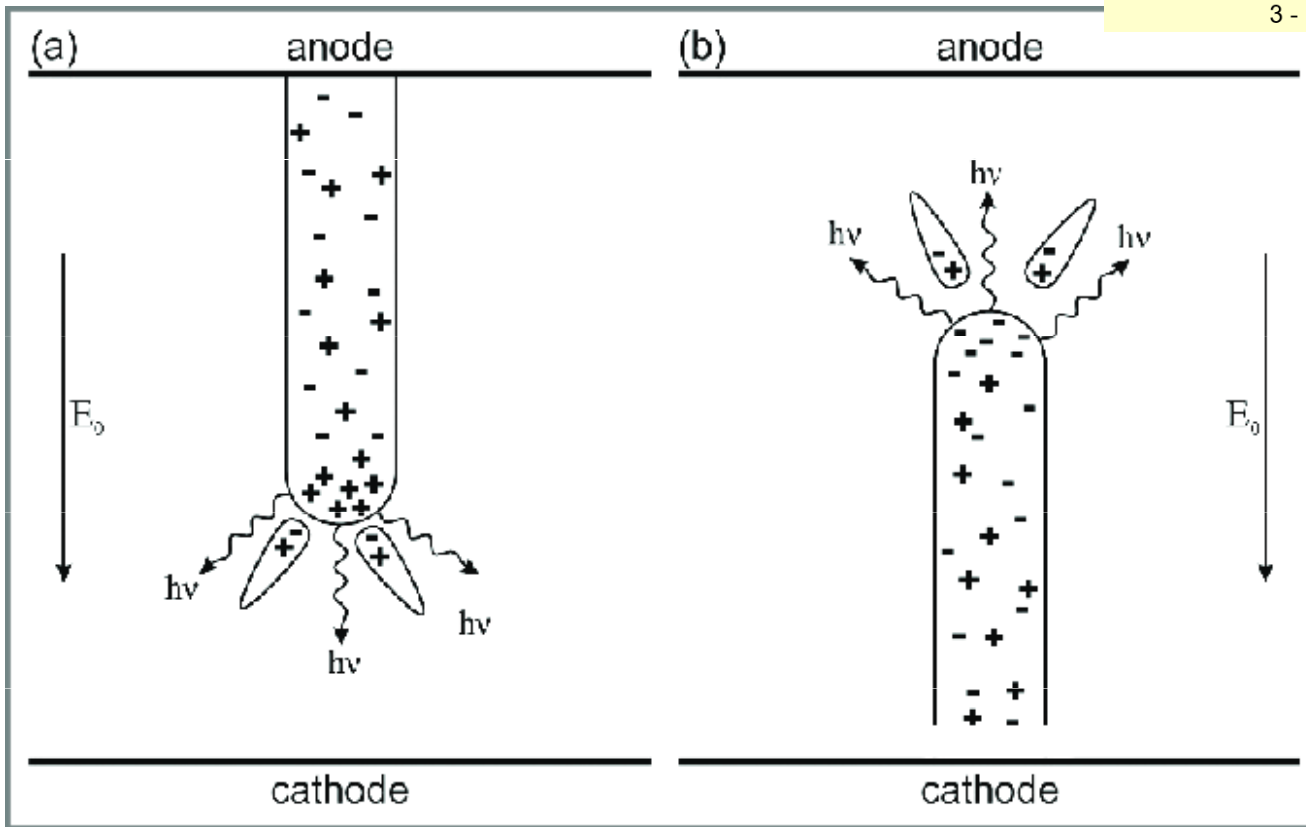
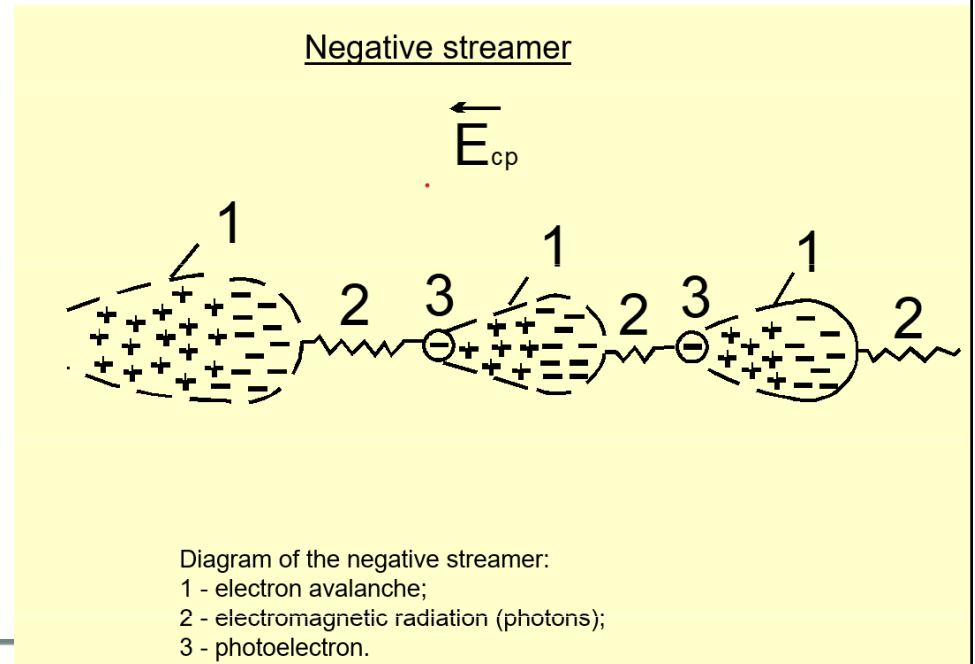

Photo-ionization



# Propagation of the negative streamer by the drift of fast electrons can be enhanced by the photoionization



***Trigatron*** is the name for the additional trigger electrode to a spark gap

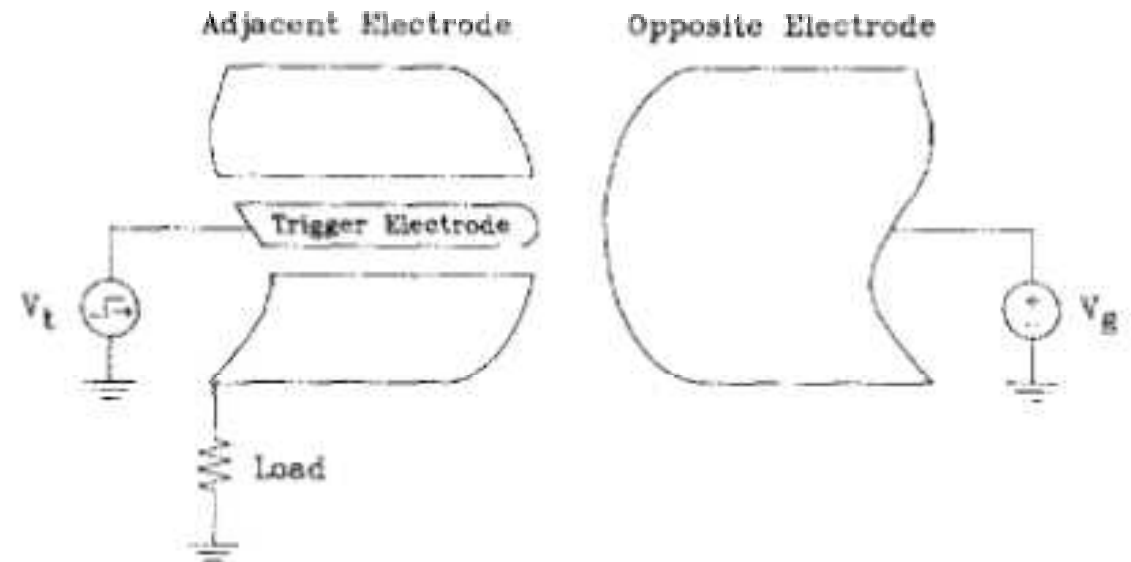

FIG. 1. Schematic drawing of a typical trigatron spark gap.

**Trigatron's advantage:** By a small discharge generated by a short on the order of 100V – 1 kV voltage pulse  $V_t$  we can ignite (i.e. switch) at well-defined time and  $V_g$  voltage value (on the order of 1 kV – 1 MV)

## TRIGATRON: shutter-camera records

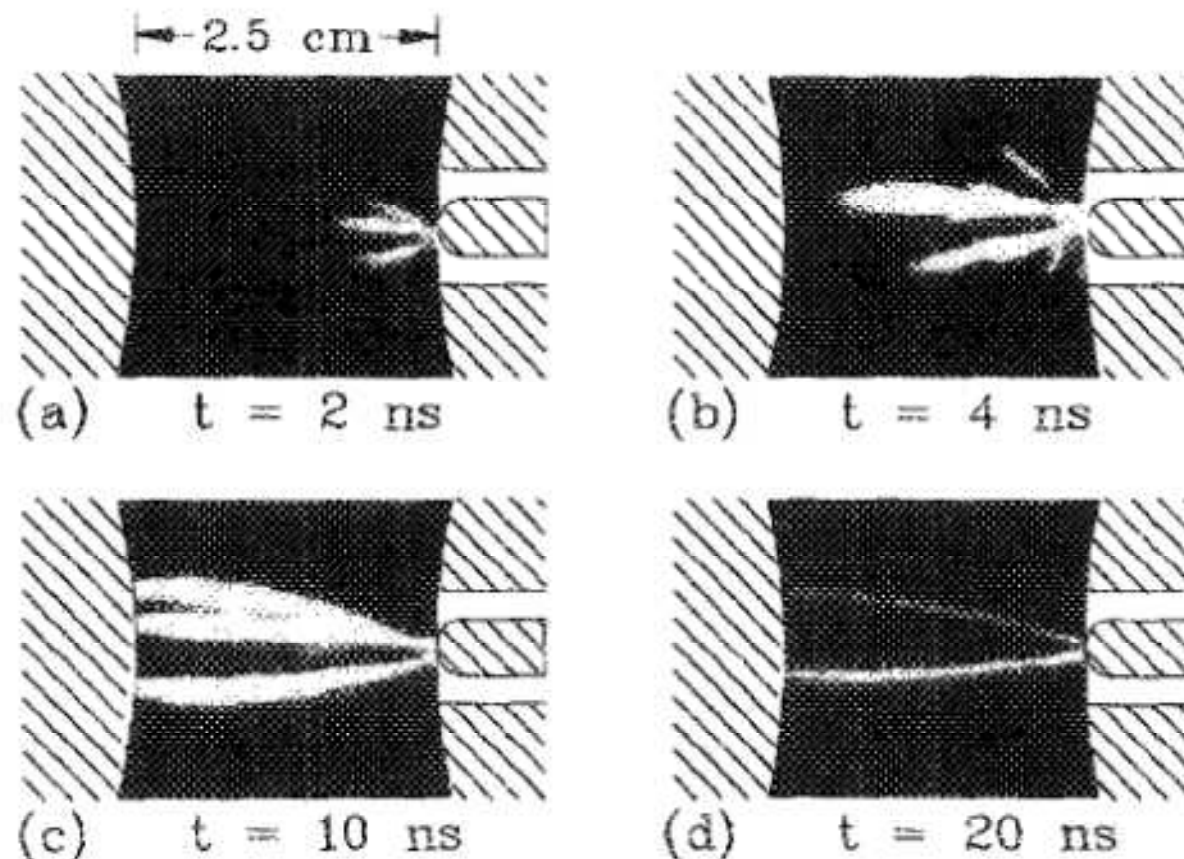
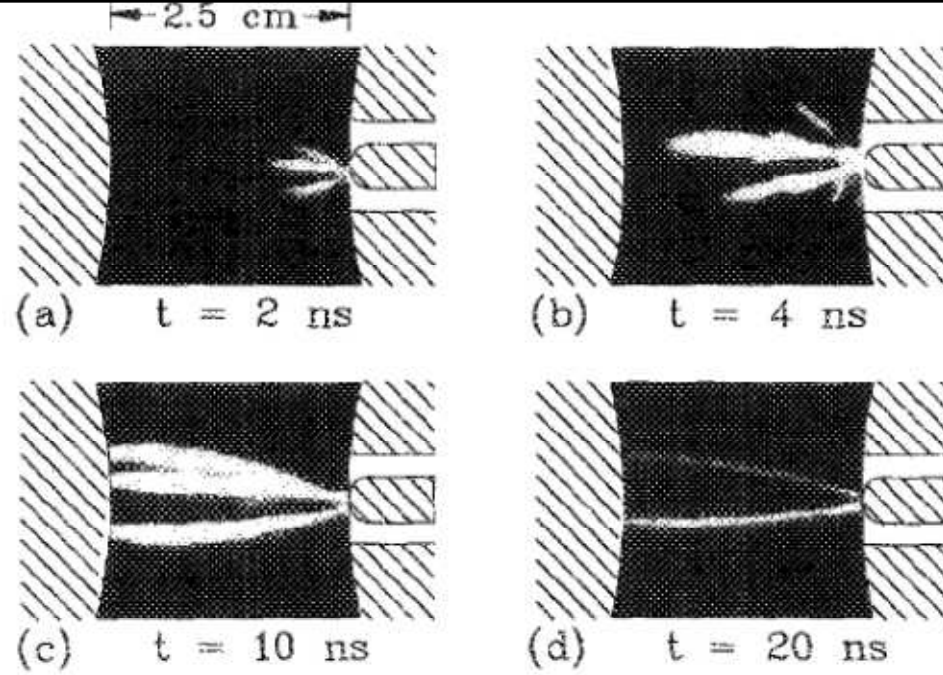

FIG. 3. Sequence of shutter photos showing the time development of cathode-directed streamers in the main gap. The streamers are pictured at various times after initiation. Due to the increasing intensity of the channels, the image intensifier gain was lower for (c) and (d). Conditions were: positive trigger, negative main gap (+ -) polarity,  $V_t = 10$  kV,  $V_g = -60$  kV,  $N_2$  at 700 Torr, 2.5-cm gap separation, and 4.76-mm-diam trigger pin flush with the main electrode.





## Streak camera records :

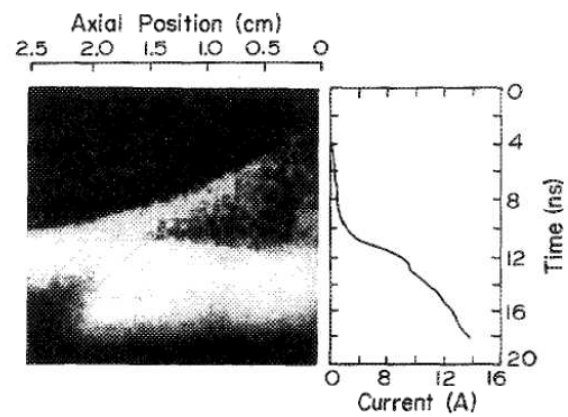
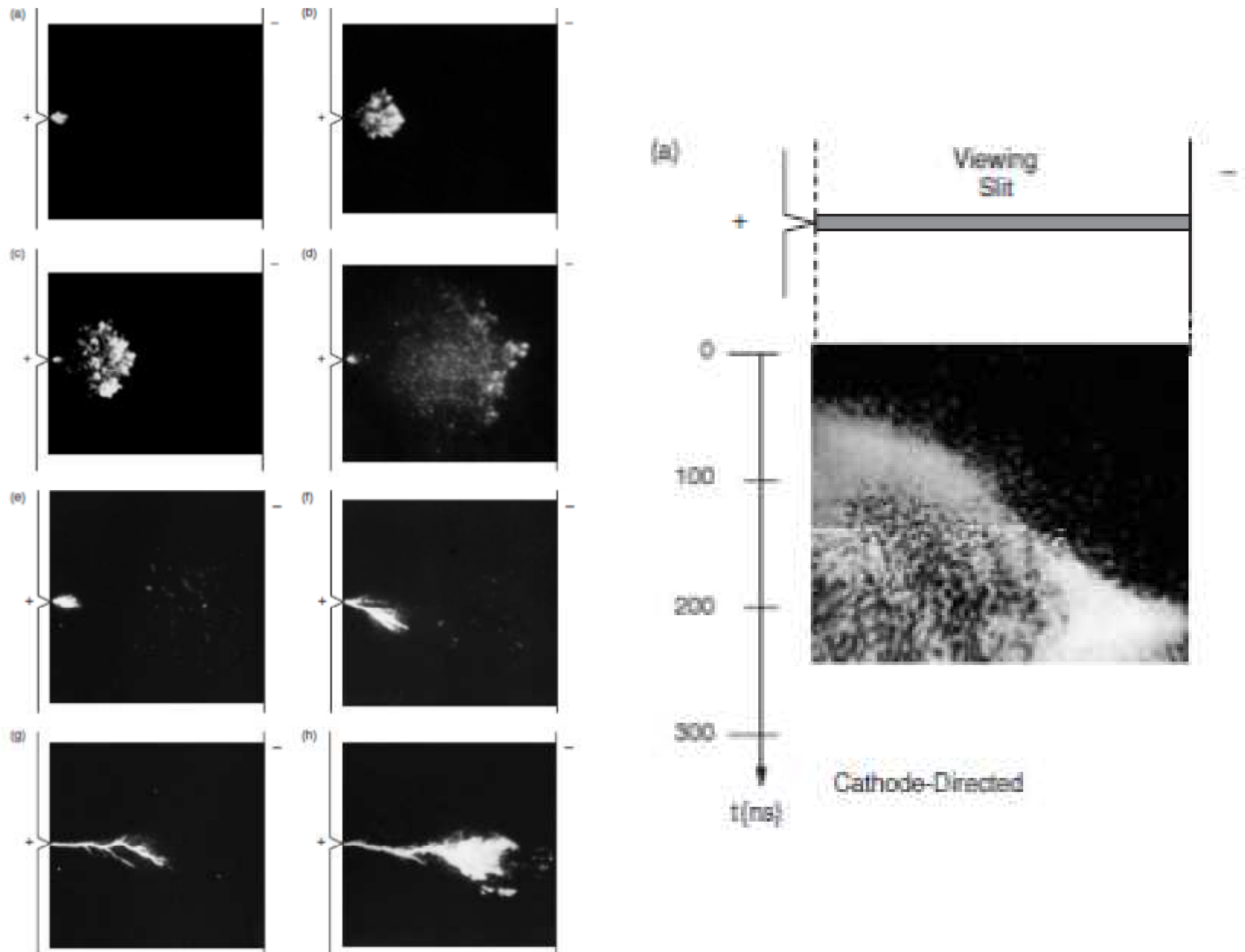
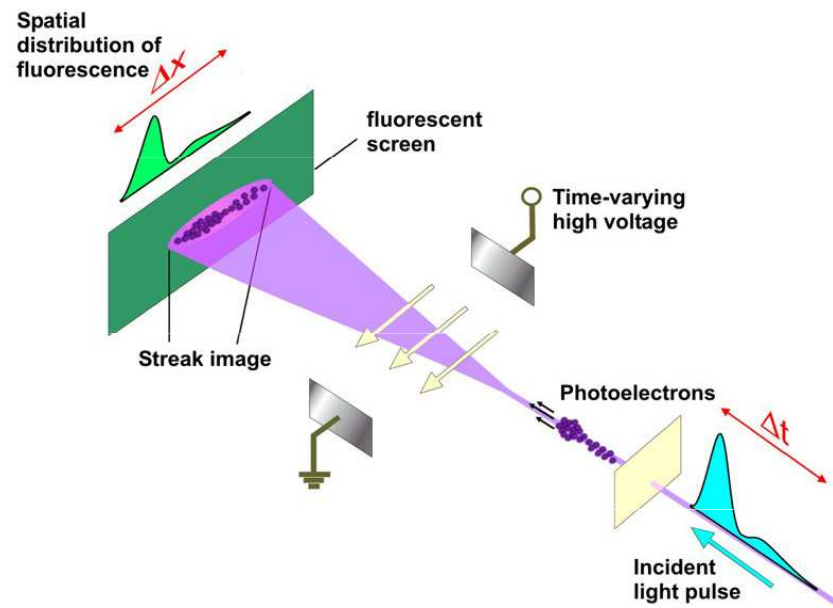
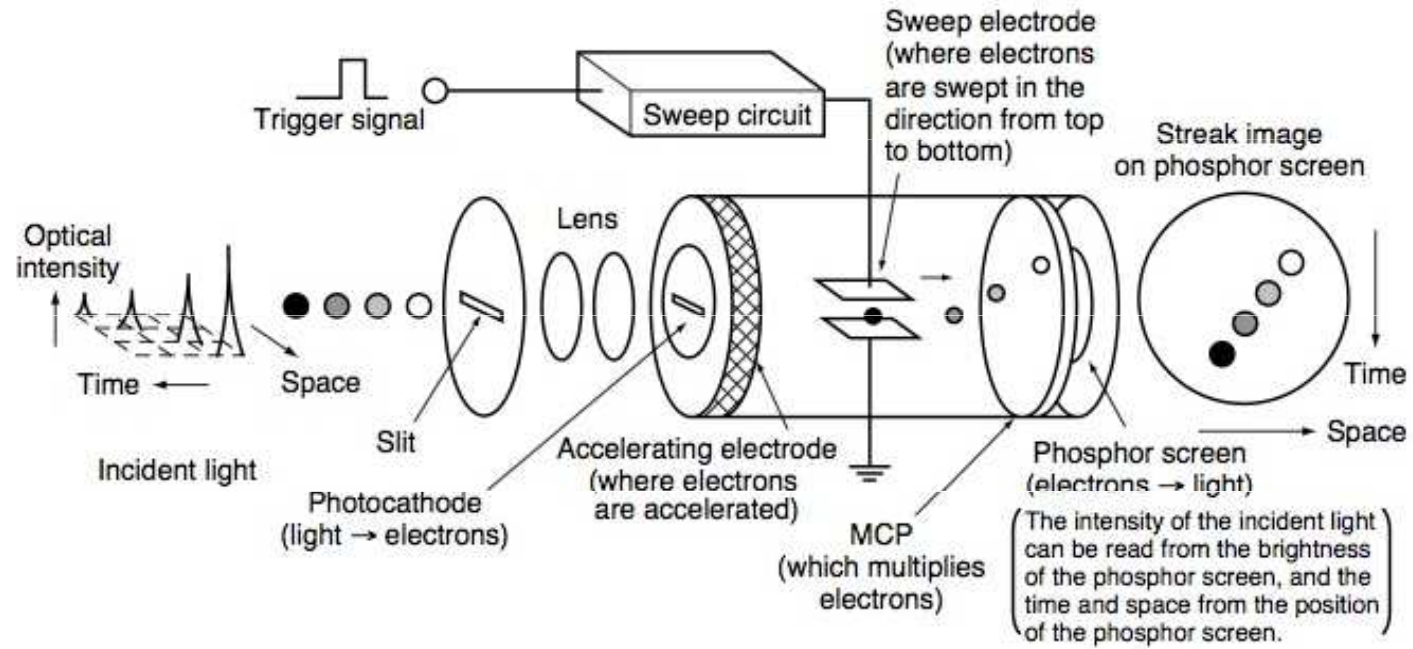

FIG. 5. Synchronized streak picture and main gap current trace, obtained under the same conditions as Fig. 3. Synchronization is accurate to within  $\pm 1 \text{ ns}$ .



**Figure 3.** Sequence of shutter photographs of cathode-directed streamers in an atmospheric pressure,  $N_2$ -filled gap. The applied voltage was 98 kV. The shutter was open for 10 ns, and the photos were obtained at about (a) 40, (b) 80, (c) 140, (d) 400, (e) 800, (f) 1300, (g) 2100, and (h) 2500 ns after the applied voltage pulse.

# STREAK CAMERA



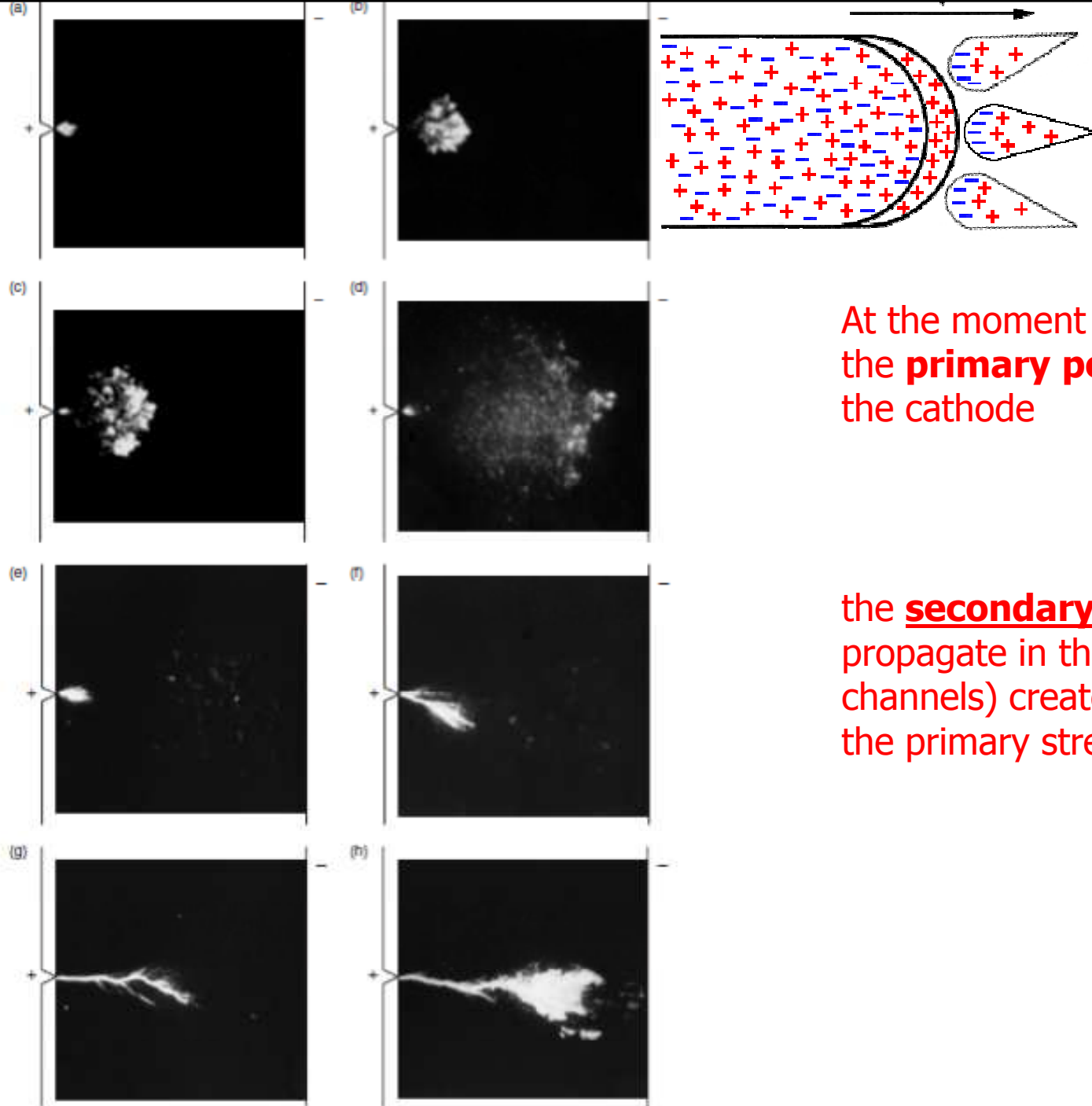

At the moment (d) of the arrival of the **primary positive streamers** to the cathode

the **secondary streamers** start to propagate in the traces (preionized channels) created by the primary streamers

**Figure 3.** Sequence of shutter photographs of cathode-directed streamers in an atmospheric pressure,  $N_2$ -filled gap. The applied voltage was 98 kV. The shutter was open for 10 ns, and the photos were obtained at about (a) 40, (b) 80, (c) 140, (d) 400, (e) 800, (f) 1300, (g) 2100, and (h) 2500 ns after the applied voltage pulse.

**In a non-uniform field the spark („breakdown“) can occur at voltages much less than in the uniform fields with the same interelectrode gap:**

**Air 1 atm., gap is 3 cm, - 25 kV (in a uniform file the breakdown strength of ambient air is 25 kV per 1 cm)**

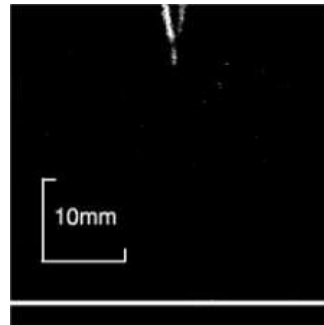

(a) Gate time = 80ns

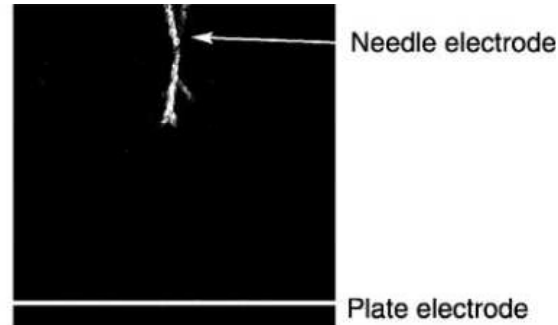

(b) Gate time = 100ns



(c) Gate time = 120ns



(d) Gate time = 160ns

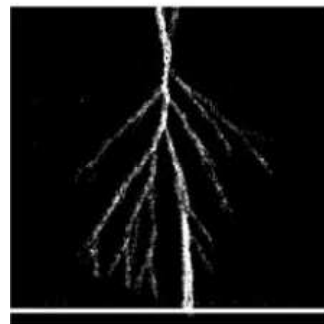

(e) Gate time = 180ns



(f) Gate time = 200ns

**The streamer speed  
is  $\sim 10^8$  cm/s**

# The explanation:

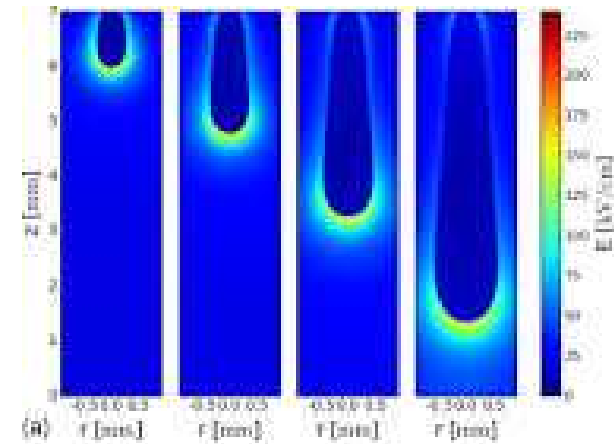
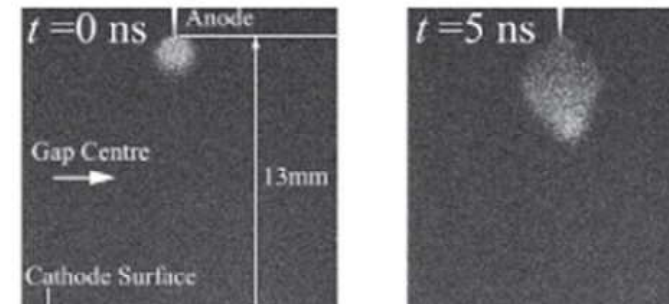
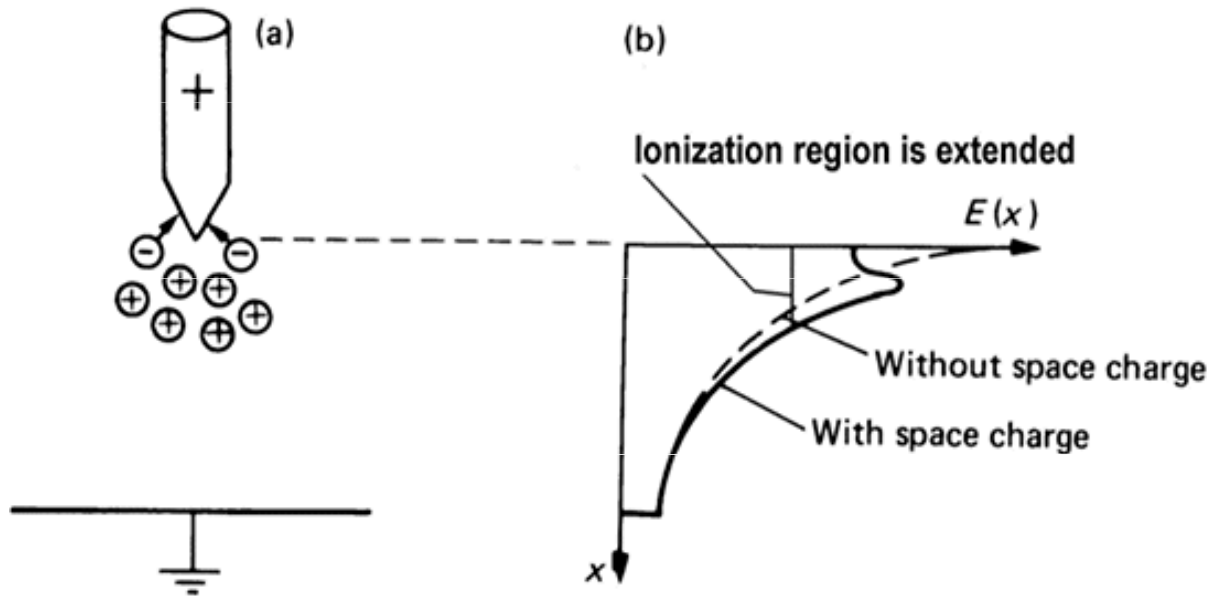

**El. field:**

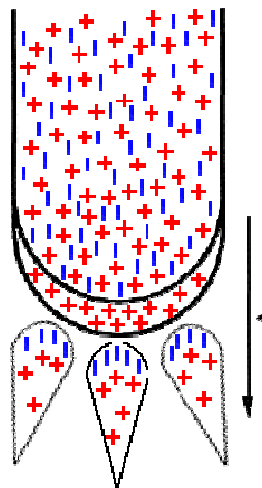

**Light:**

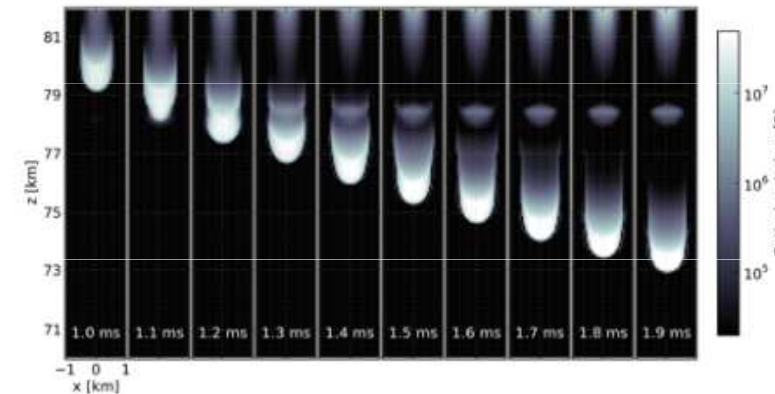

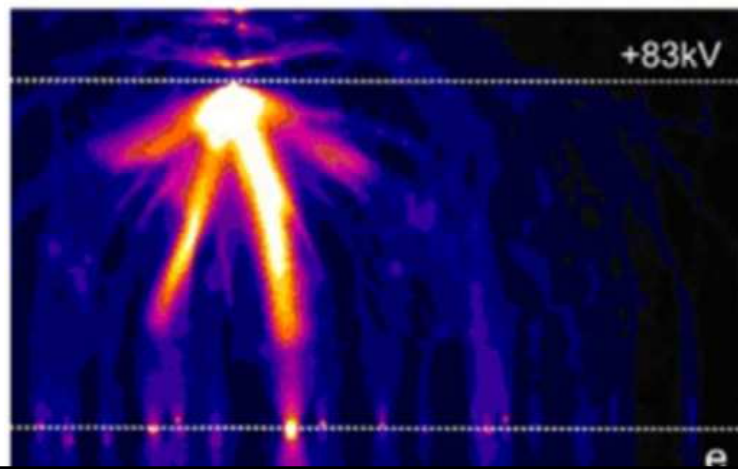
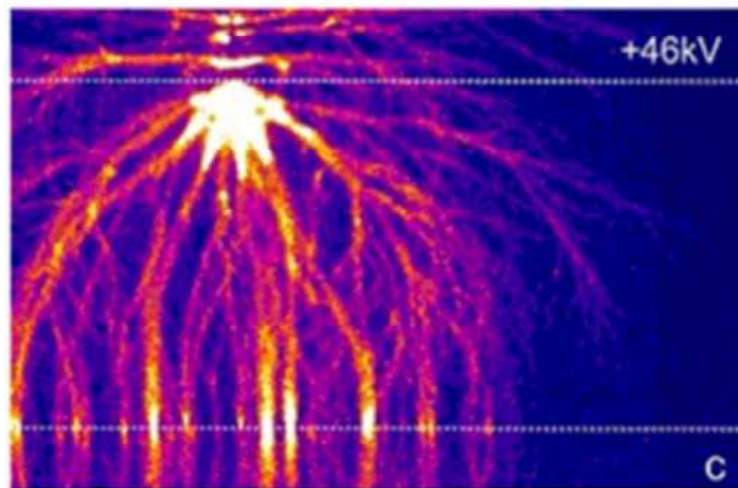
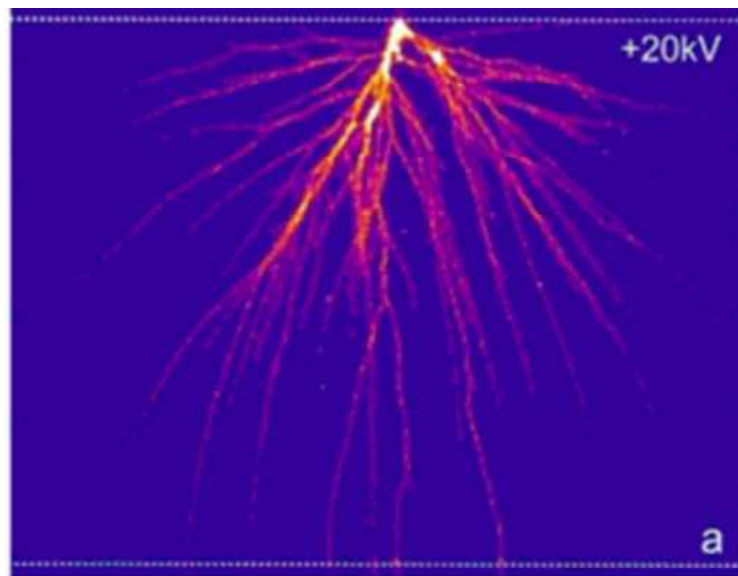

## Non-uniform field with the sharp anode

Air 1 atm./4 cm

At the arrival of the primary streamers to the cathode the glow-discharge-type cathode spots are generated, which provide electrons for the discharge channels like the cathode regions of GDs

At the same moment the secondary streamers are starting from the anode. The secondary streamers create well-conductive channels of nearly equilibrium „hot“ plasma

The arc-type cathode spot is created by the arrival of the secondary streamer

## Streak and shutter camera records:

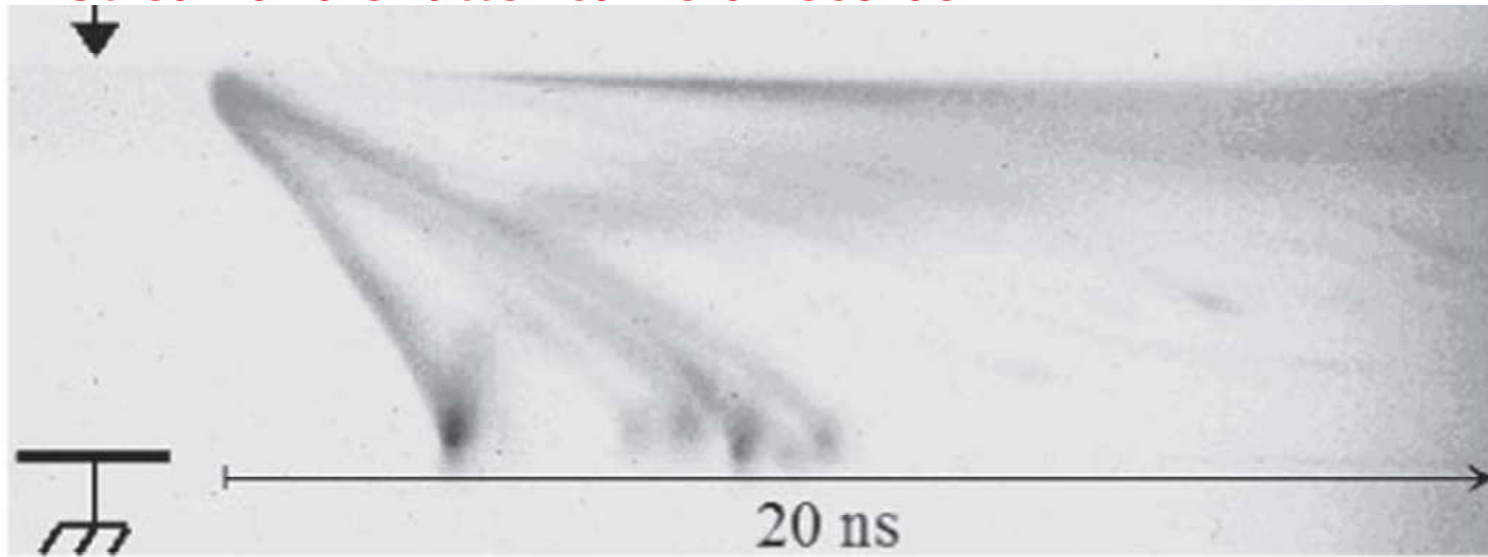

<= the secondary streamers

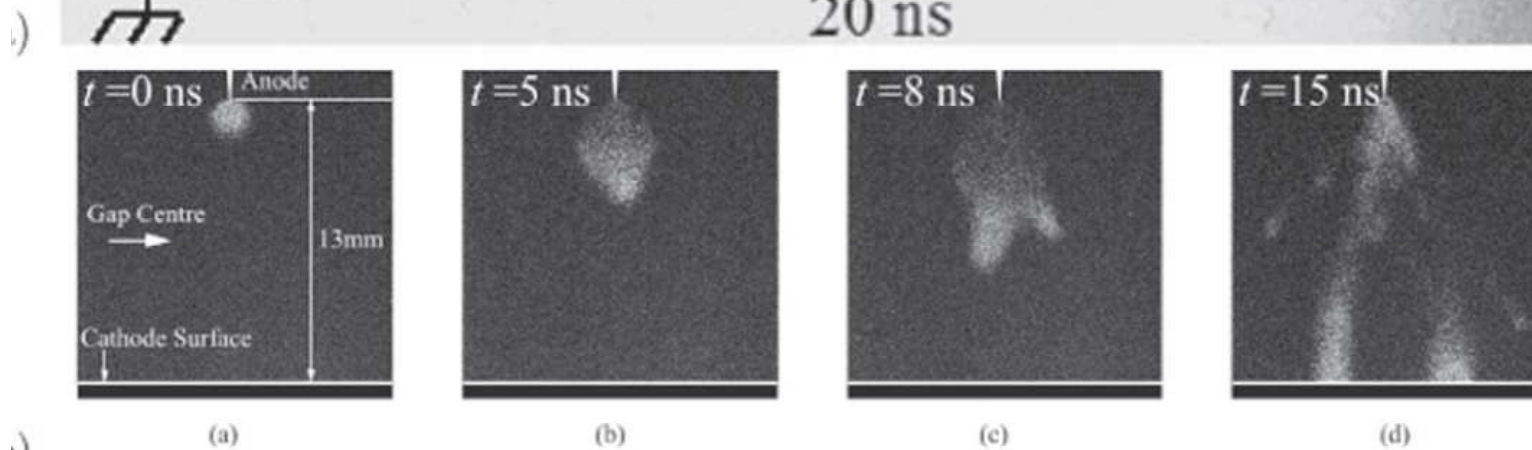

Streak camera record in a 2 cm ambient air gap with an anode radius of  $50 \mu\text{m}$ . The applied voltage and streak are  $36.8 \mu\text{kV}$  and 20 ns, respectively. ICCD camera records made in a 1.3 cm ambient air gap with an anode radius of  $80 \mu\text{m}$ , applied voltage of 35 kV at exposure times of 2

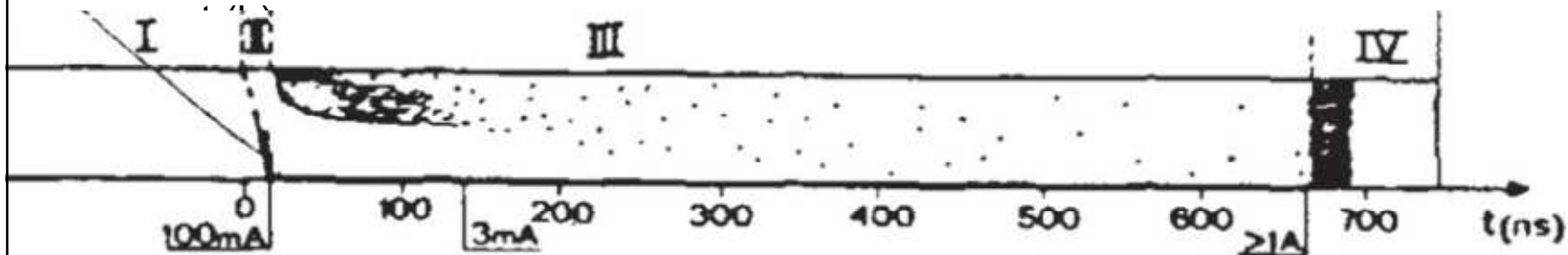



## STREAMER BREAKDOWN ALWAYS OCCURS IN THE FOLLOWING SEQUENCE OF EVENTS

- (a) **The avalanche stage**, wherein the streamer initiating charge in a localized region is formed by charges generated in a single avalanche or more often accumulated in a sequence of avalanches
- (b) **The positive primary streamer initiation**: after an initial delay, when the streamer initiating charge partially shields itself from the external field forming a 'critical' region of relatively dense plasma ( $10^{13}$ – $10^{15}$  cm<sup>-3</sup>) resulting in the primary positive streamer starts to propagate.
- (c) **The positive streamer propagation**, where the primary streamer head propagates as a luminous spot of the diameter typically less than 1 mm with the velocity usually in the range  $10^7$ – $10^8$  cm s<sup>-1</sup> followed by a less luminous streamer trail.
- (d) **The streamer arrival to the cathode**, forming an active glow-discharge type cathode spot, which is effectively producing the electrons by direct impact ionization in the cathode fall
- (e) **The filamentary glow to arc transition** is often initiated by the growth of secondary streamers

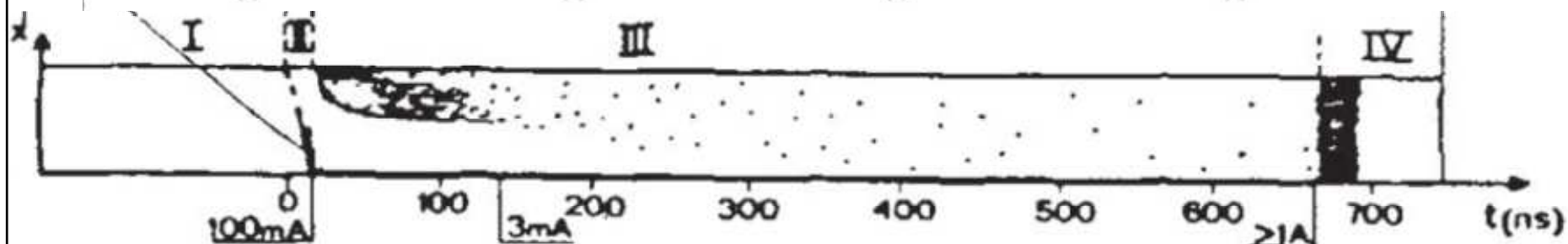
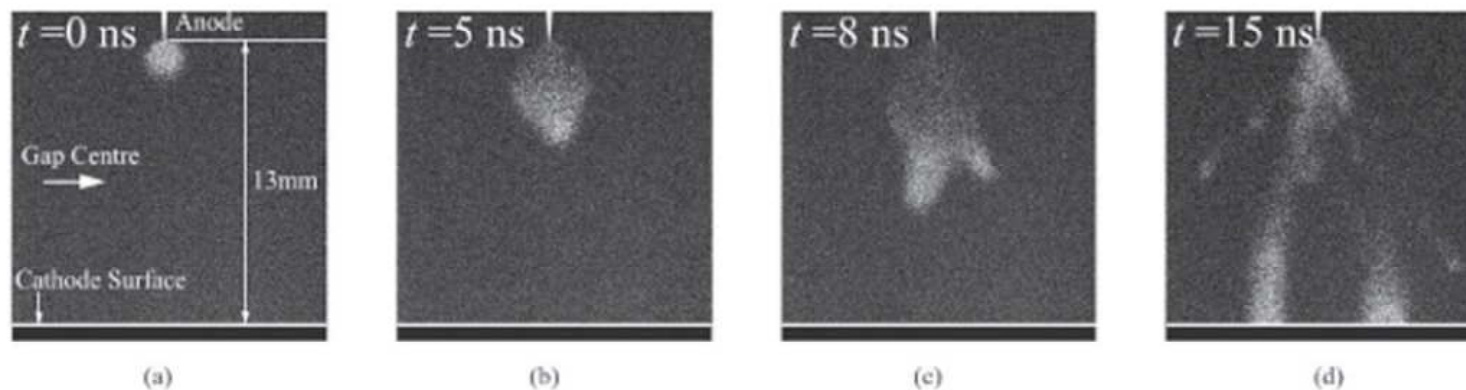

To generate the non-equilibrium plasma at near-atmospheric pressures (important for many applications) it is necessary to avoid of „ **(e) The filamentary glow to arc transition**“

It can be done in the following types of the non-stationary high-pressure discharges (or their combinations)

- 1. Impulse discharges** (*impulse coronas, the discharges on TEA lasers*)
- 2. Corona discharges** (*DC or AC*)
- 3. Dielectric barrier discharges** (*one or several dielectric „barriers“ are situated on the electrode surfaces, or in the gap*)

## Impulse corona discharge for plasmachemical applications (see the primary **p** and the secondary **s** streamers)

Ryo Ono and Tetsuji Oda 2004 *Jpn. J. Appl. Phys.* **43** 321

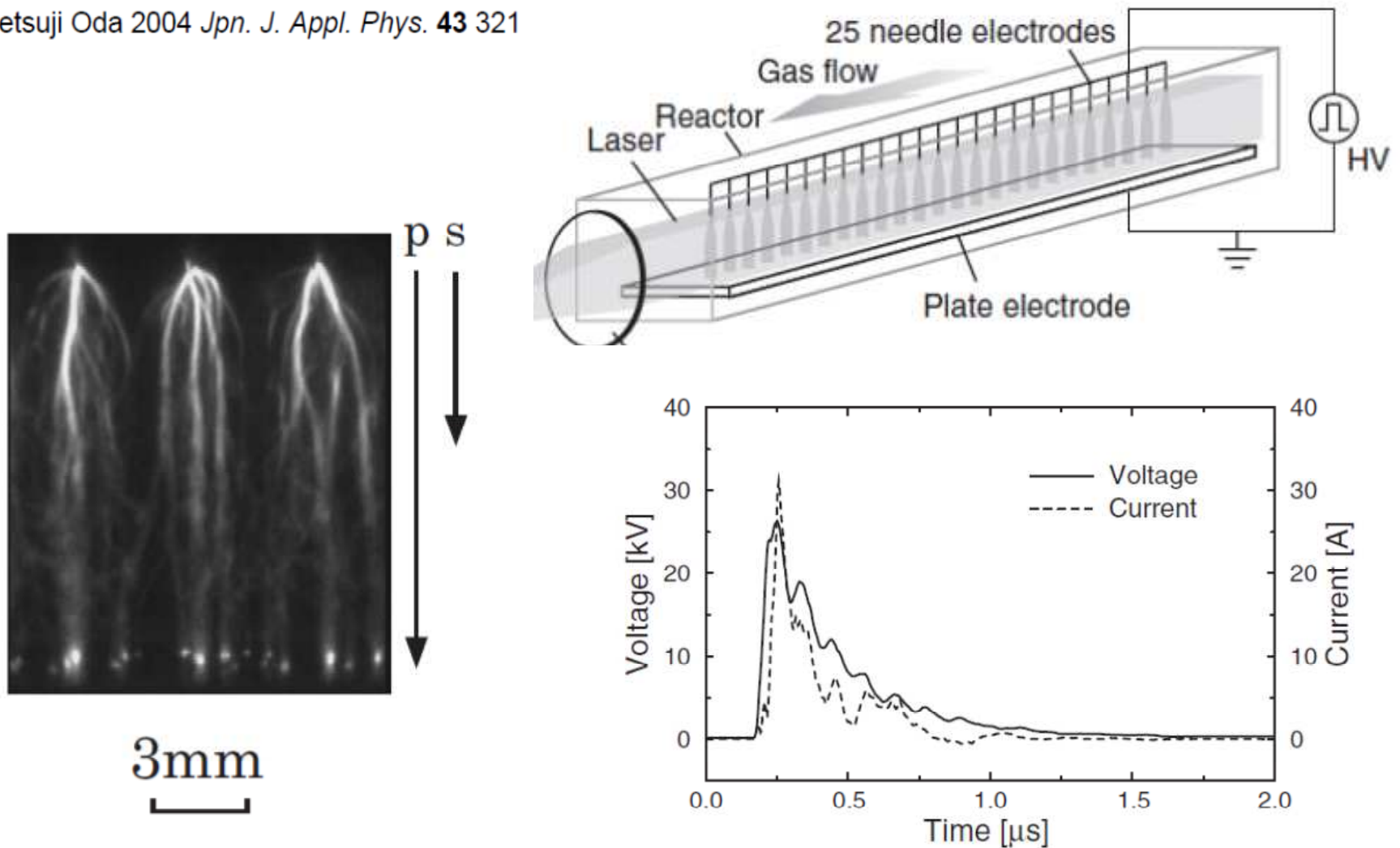
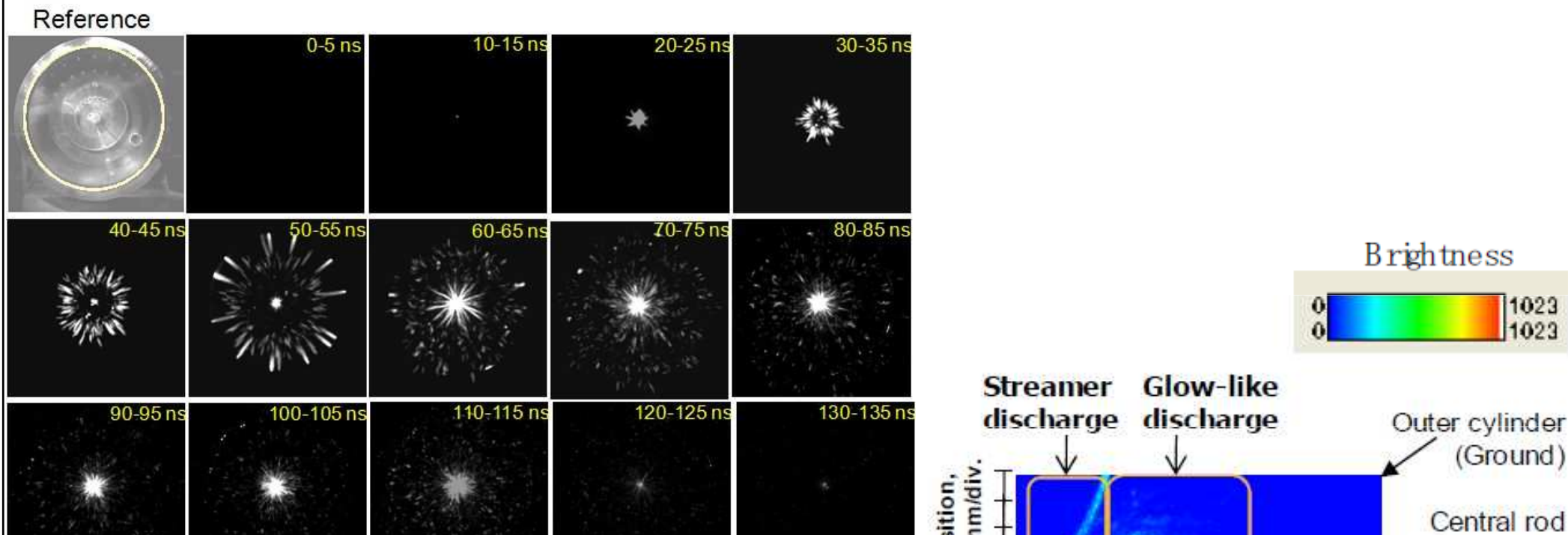
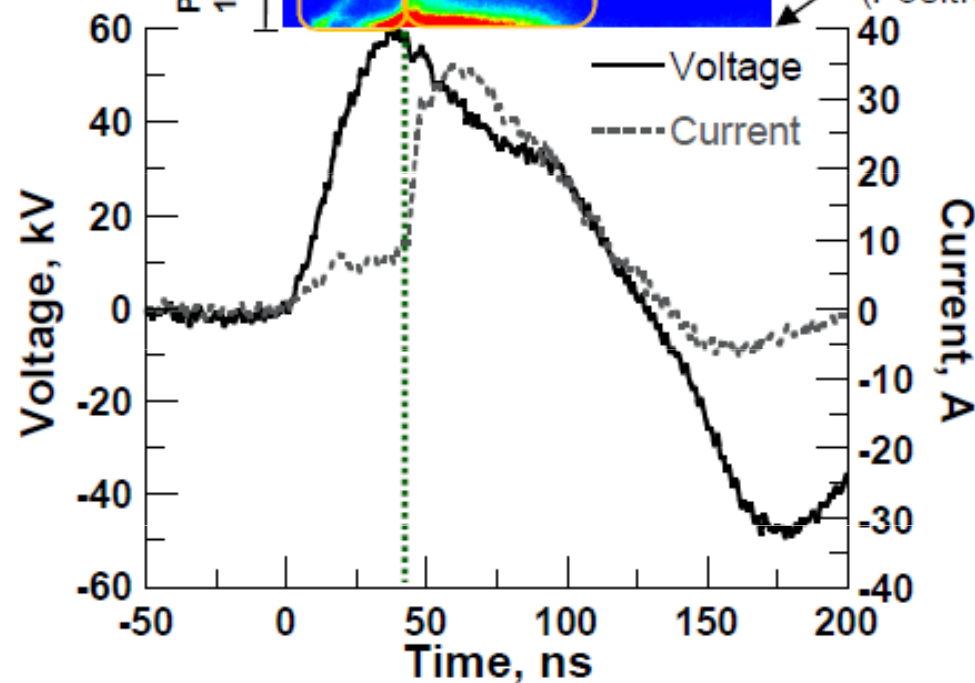

Fig. 6. Streamer photograph obtained by ICCD camera with 3  $\mu$ s optical gate in  $\text{H}_2\text{O}(2\%)/\text{N}_2$  mixture. The applied voltage is 30 kV. Arrow 'p' represents propagation length of the primary streamer, and arrow 's' represents that of the secondary streamer.

A rod electrode made of stainless steel, 0.5 mm in diameter and 10 mm in length was placed concentrically in a copper cylinder, 76 mm in diameter.



**Impulse corona discharge with a dielectric barrier on the anode surface**



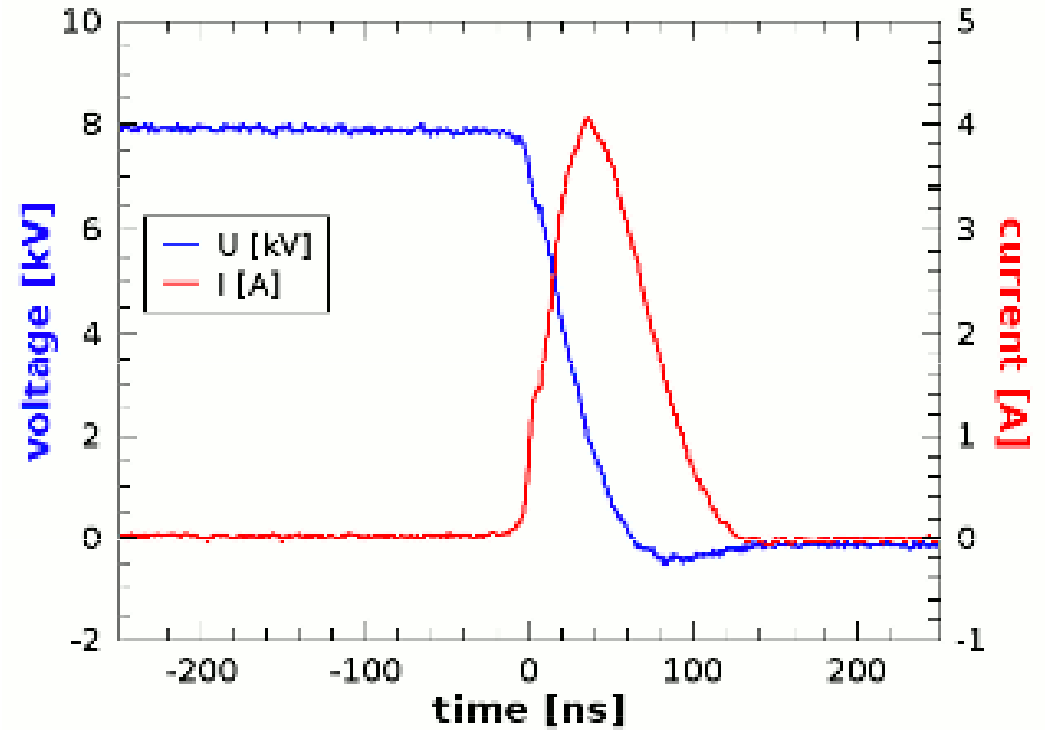

Photograph of **positive „impulse corona"** in needle – water gap 4 mm long.

*Typical voltage and current waveforms*

## STREAMER BREAKDOWN ALWAYS OCCURS IN THE FOLLOWING SEQUENCE OF EVENTS

- (a) **The avalanche stage**, wherein the streamer initiating charge in a localized region is formed by charges generated in a single avalanche or more often accumulated in a sequence of avalanches
- (b) **The positive primary streamer initiation**: after an initial delay, when the streamer initiating charge partially shields itself from the external field forming a 'critical' region of relatively dense plasma ( $10^{13}$ – $10^{15}$   $\text{cm}^{-3}$ ) resulting in the primary positive streamer starts to propagate.
- (c) **The positive streamer propagation**, where the primary streamer head propagates as a luminous spot of the diameter typically less than 1 mm with the velocity usually in the range  $10^7$ – $10^8$   $\text{cm s}^{-1}$  followed by a less luminous streamer trail.
- (d) **The streamer arrival to the cathode**, forming an active glow-discharge type cathode spot, which is effectively producing the electrons by direct impact ionization in the cathode fall
- (e) **The filamentary glow to arc transition** is often initiated by the growth of secondary streamers

