

# Molecular identification

Species, individual, sex

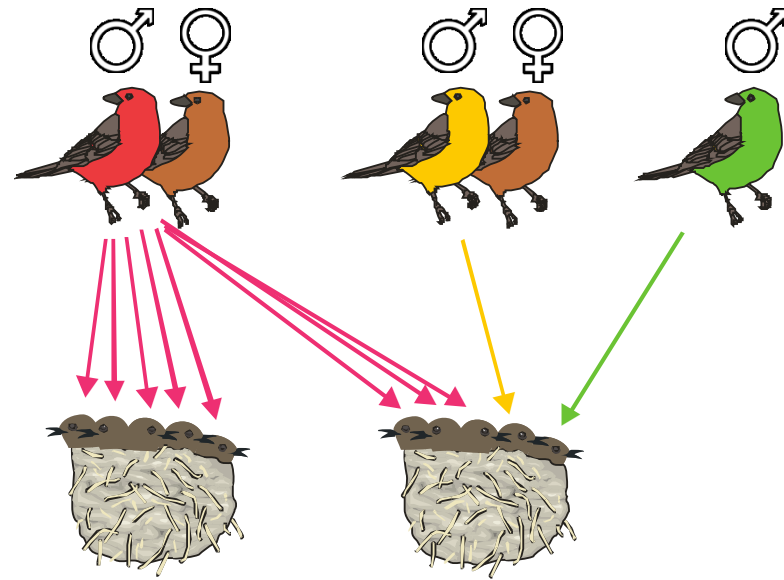

# Identification of species

DNA barcoding

**WHAT THE SPECIES IS AND DO WE  
NEED THEM?**

# Is it possible to define a species?

It is really laughable to see what different ideas are prominent in various naturalists minds, when they speak of „species“; ... It all comes, I believe, from trying to define the indefinable.

*C. Darwin, 24 Dec 1856  
(Letter to J.D. Hooker)*

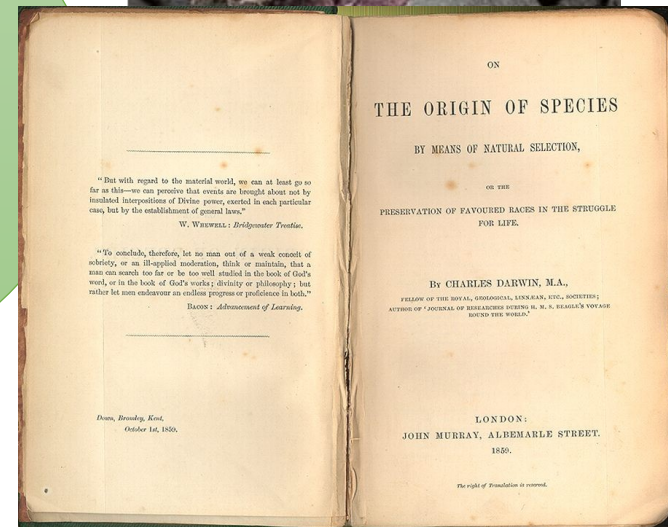
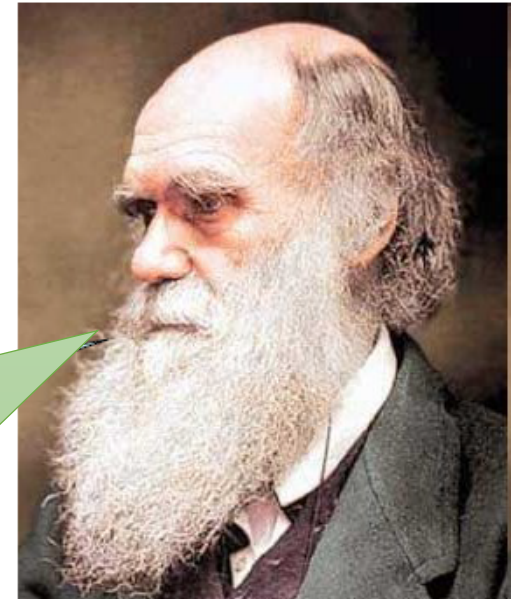



# Species concepts in biology

- Agamospecies
- Biological
- Biosimilarity
- Cladistic
- Cohesion
- Compilospecies
- Differential Fitness
- Ecological
- Evolutionarily Significant Unit
- Evolutionary
- Genealogical
- Genealogical Concordance
- General Lineage
- Genetic
- Genic
- Genotypic cluster
- Hennigian
- Internodal
- Least Inclusive Taxonomic Unit
- Morphological
- Non-dimensional
- Nothospecies
- Phenetic
- Phylogenetic (Diagnosability Version)
- Phylogenetic (Monophyly Version)
- Phylo-Phenetic
- Pragmatic
- Recognition
- Reproductive Competition
- Successional
- Taxonomic
- Unified

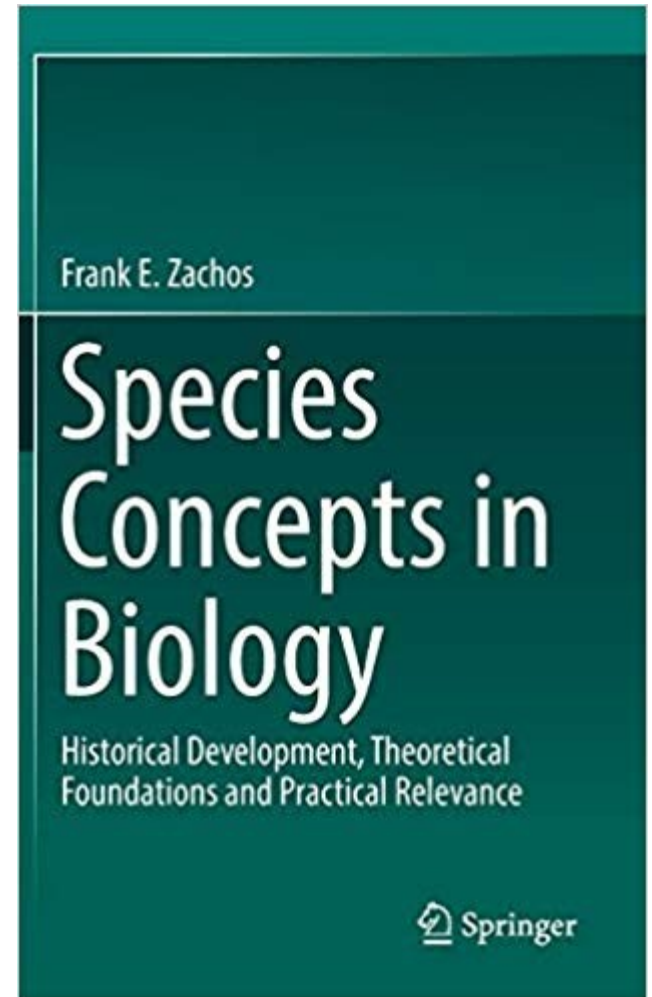

# Morphological Species Concept

- = the smallest groups that are consistently and **persistently distinct, and distinguishable by ordinary means**
- Aristoteles → Linnaeus → rules of zoological nomenclature
- does not take evolution into account

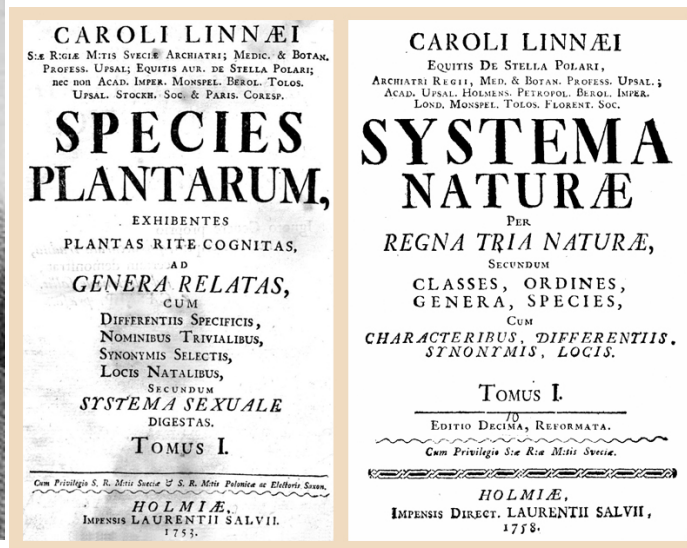

Linnaeus, Carolus (1707 - 1778)

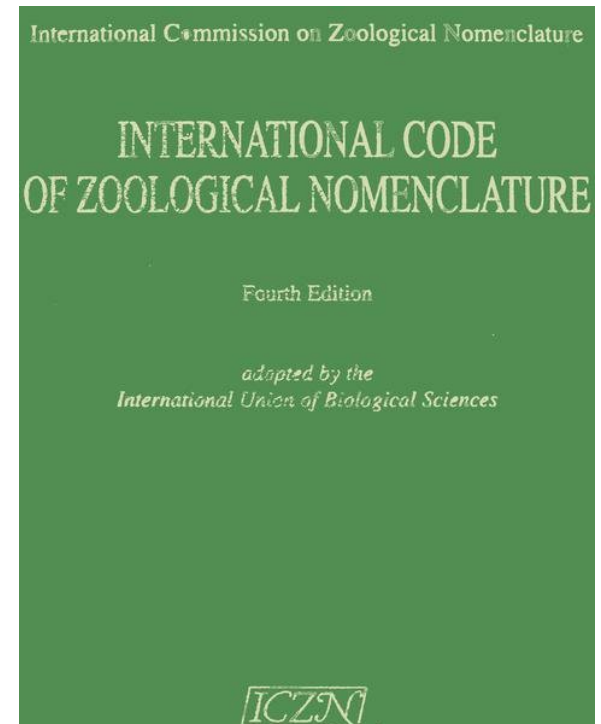

# Biological Species Concept

- = **interbreeding natural populations reproductively isolated from other such group**
- reproductive isolation mechanisms (RIM) = post- or prezygotic barriers of reproduction
- **most popular** – it is intuitive and it was promoted most successfully (e.g. by influential evolutionary biologists of the 20th century as main concept of Modern Synthesis)
- problems: allopatric and allochronic populations/species, ...

# Complications: Parapatric contact zones

- *Erinaceus* – distinct species (minimal hybridization)

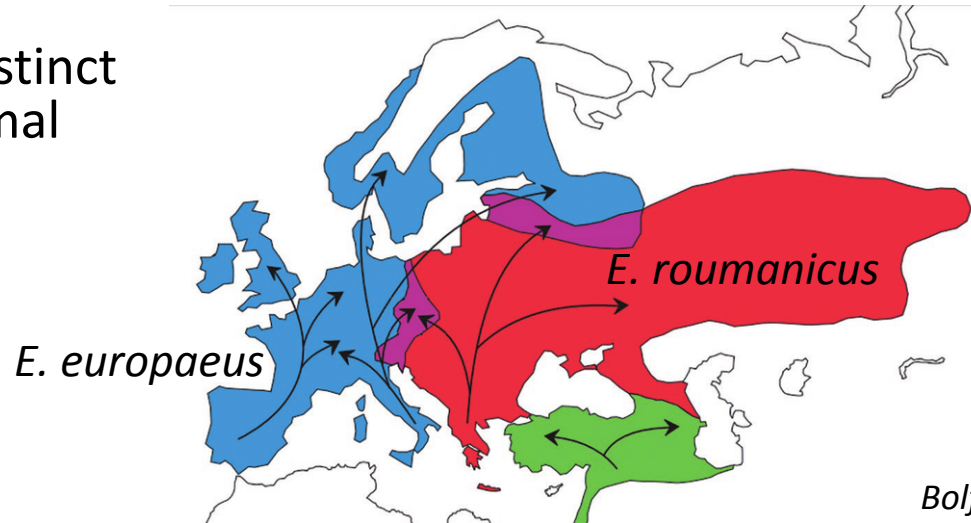

*Bolfiková and Hulva 2012*

- house mice – distinct subspecies (substantial hybridization)



*Macholán et al. 2008*

# Complications: Ring species



A.

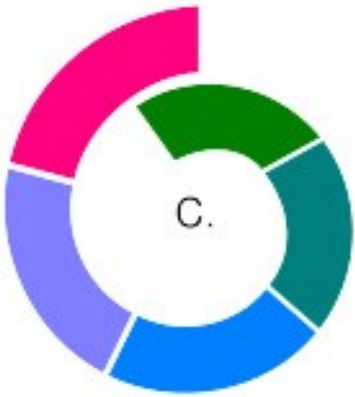
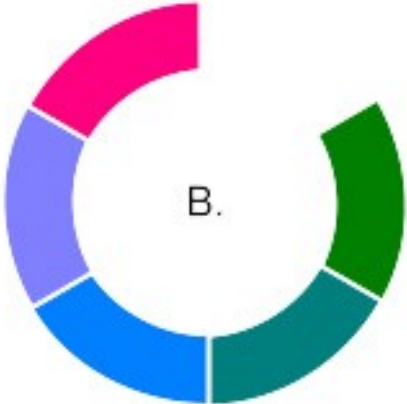



# Complications: Physical constraints



# Phylogenetic species concept (Diagnosability Version)

- = the smallest population or group of populations, within which there is a **parental pattern of ancestry and descent**
- two populations are considered species if they are **100% diagnostic** (e.g. discriminant analysis of morphometric data or allele frequency data)
- recent **paradigmatic shift from the Biological Species Concept to Phylogenetic Species Concept**
- extreme cases: descendants of a single mother with a mutation at mtDNA can be 100% diagnosed (i.e. should be considered species)

# Example: Taxonomy of ungulates

- increase from 143 (Grubb 2005) to 279 (Groves and Leslie 2011 - Handbook of the Mammals of the World) species of bovid ungulates

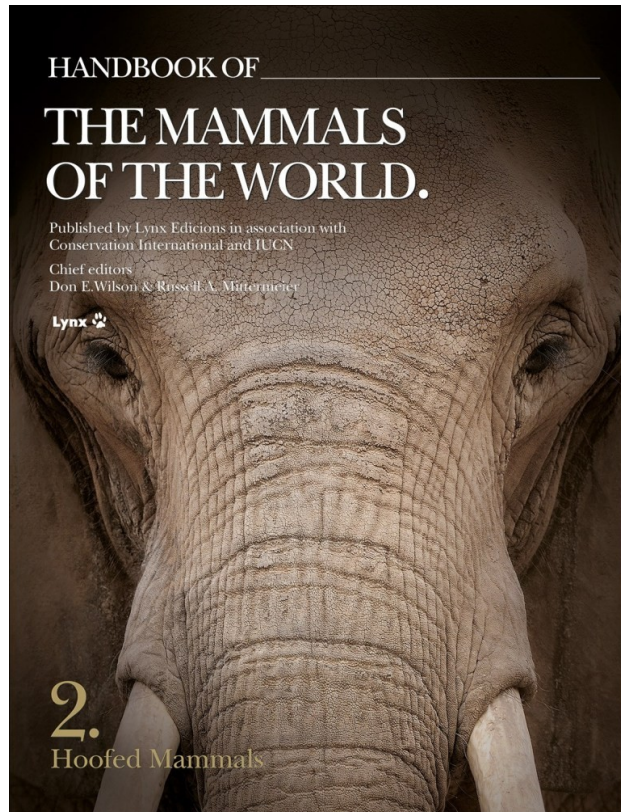

klipspringers  
*Oreotragus* –  
from one to 11  
species

# Consequences intensively debated

- „pros“ papers

Horizon Scanning Article

**“Taxonomic inflation” in the historical context of mammalogy and conservation**

Spartaco GIPPOLITI<sup>a,\*</sup>, Colin P. GROVES<sup>b</sup>

<sup>a</sup>Viale Liegi 48, 00198 Roma, Italy  
<sup>b</sup>School of Archaeology & Anthropology, Australian National University, Canberra, Australia

BIOLOGICAL REVIEWS Cambridge Philosophical Society

*Biol. Rev.* (2010), 85, pp. 115–130.  
doi: 10.1111/j.12335

115

**Impacts of taxonomic inertia for the conservation of African ungulate diversity: an overview**

Spartaco Gippoliti<sup>1</sup>, Fenton P. D. Cotterill<sup>2</sup>, Dietmar Zinner<sup>3,\*</sup> and Colin P. Groves<sup>4</sup>

Conserv Genet  
DOI 10.1007/s10592-017-0976-0

 CrossMark

PERSPECTIVE

**Species definitions and conservation: a review and case studies from African mammals**

Colin P. Groves<sup>1</sup> · F. P. D. Cotterill<sup>2</sup> · Spartaco Gippoliti<sup>3</sup> · Jan Robovský<sup>4</sup> · Christian Roos<sup>5</sup> · Peter J. Taylor<sup>6,7</sup> · Dietmar Zinner<sup>8</sup>

*Syst. Biol.* 63(5):819–832, 2014  
©The Author(s) 2014. Published by Oxford University Press, on behalf of the Society of Systematic Biologists. All rights reserved.  
For Permissions, please email: journals.permissions@oup.com  
DOI:10.1093/sysbio/syu003  
Advance Access publication January 11, 2014

**Why One Century of Phenetics is Enough: Response to “Are There Really Twice As Many Bovid Species As We Thought?”**

FENTON P. D. COTTERILL<sup>1,\*</sup>, PETER J. TAYLOR<sup>2</sup>, SPARTACO GIPPOLITI<sup>3</sup>, JACQUELINE M. BISHOP<sup>4</sup>, AND COLIN P. GROVES<sup>5</sup>

Commentary

**Mammal taxonomy without taxonomists: a reply to Zachos and Lovari**

Spartaco GIPPOLITI<sup>a,\*</sup>, Fenton P.D. COTTERILL<sup>b</sup>, Colin P. GROVES<sup>c</sup>

- „cons“ papers

Opinion TRENDS in Ecology and Evolution Vol.19 No.9 September 2004

 

**Taxonomic inflation: its influence on macroecology and conservation**

Nick J. B. Isaac<sup>1</sup>, James Mallet<sup>2</sup> and Georgina M. Mace<sup>1</sup>

Mammalian Biology 78 (2013) 1–6

Contents lists available at ScienceDirect

**Mammalian Biology**

journal homepage: www.elsevier.com/locate/mambio

Point of View

Species inflation and taxonomic artefacts—A critical comment on recent trends in mammalian classification

Frank E. Zachos<sup>a,\*</sup>, Marco Apollonio<sup>b</sup>, Eva V. Bärmann<sup>c</sup>, Marco Festa-Bianchet<sup>d</sup>, Ursula Göhlich<sup>a</sup>, Jan Christian Habel<sup>e</sup>, Elisabeth Haring<sup>a,f</sup>, Luise Kruckenhauser<sup>g</sup>, Sandro Lovari<sup>h</sup>, Allan D. McDevitt<sup>h</sup>, Cino Pertoldi<sup>i</sup>, Gertrud E. Rössner<sup>j,k,l</sup>, Marcelo R. Sánchez-Villagra<sup>m</sup>, Massimo Scandura<sup>b</sup>, Franz Suchentrunk<sup>n</sup>

*Syst. Biol.* 62(3):490–493, 2013  
© The Author(s) 2013. Published by Oxford University Press, on behalf of the Society of Systematic Biologists. All rights reserved.  
For Permissions, please email: journals.permissions@oup.com  
DOI:10.1093/sysbio/syt004  
Advance Access publication January 29, 2013

**Are There Really Twice as Many Bovid Species as We Thought?**

RASMUS HELLER<sup>1,2,\*</sup>, PETER FRANSDSEN<sup>1</sup>, ELINE D. LORENZEN<sup>3,4</sup>, AND HANS R. SIEGISMUND<sup>1</sup>

*Syst. Biol.* 63(5):833–837, 2014  
© The Author(s) 2014. Published by Oxford University Press, on behalf of the Society of Systematic Biologists. All rights reserved.  
For Permissions, please email: journals.permissions@oup.com  
DOI:10.1093/sysbio/syu004  
Advance Access publication May 15, 2014

**Is Diagnosability an Indicator of Speciation? Response to “Why One Century of Phenetics Is Enough”**

RASMUS HELLER<sup>1,2,\*</sup>, PETER FRANSDSEN<sup>1</sup>, ELINE DEIRDRE LORENZEN<sup>3,4</sup>, AND HANS R. SIEGISMUND<sup>1</sup>

JOURNAL OF BIOLOGICAL SYSTEMICS – EVOLUTIONARY RESEARCH

© 2014 Blackwell Verlag GmbH *J. Zool. Syst. Evol. Res.* doi: 10.1111/jzs.12088

Letter to the Editor

Natural History Museum Vienna, Mammal Collection, Vienna, Austria

**Taxonomic inflation, the Phylogenetic Species Concept and lineages in the Tree of Life – a cautionary comment on species splitting**

FRANK E. ZACHOS



# Why does it matter? The power of names!

- description of *Nessiteras rhombopteryx* in Nature
- „the Loch Ness monster“ – if indeed it does exist, it exists in small numbers and deserves protection
- to be protected it must have a taxonomic name



466

## Naming the Loch Ness monster

Recent publicity concerning new claims for the existence of the Loch Ness monster has focused on the evidence offered by Sir Peter Scott and Robert Rines. Here, in an article planned to coincide with the now-cancelled symposium in Edinburgh at which the whole issue was due to be discussed, they point out that recent British legislation makes provision for protection to be given to endangered species; to be granted protection, however, an animal should first be given a proper scientific name.

Better, they argue, to be safe than sorry; a name for a species whose existence is still a matter of controversy among many scientists is preferable to none if its protection is to be assured. The name suggested is *Nessiteras rhombopteryx*.

**S**CHEDULE 1 of the Conservation of Wild Creatures and Wild Plants Act, 1975, passed recently by the UK Parliament, provides the best way of giving full protection to any animal whose survival is threatened. To be included, an animal should be given a common name and a scientific name. For the Nessie or Loch Ness monster, this would require a formal description, even though the creature's relationship with known species, and even the taxonomic class to which it belongs, remain in doubt.

On August 8, 1972, a team from the Academy of Applied Science, Boston, Massachusetts, working in conjunction with the Loch Ness Investigation Bureau of London, obtained what seems to be the most precise evidence on which to base such a description. Two consecutive underwater photographs (Fig. 1) were taken by a stationary time-lapse camera with strobe flash, operating automatically at a depth of 45 feet in Loch Ness, along with a simultaneous sonar trace (Fig. 2). The photographs have been computer enhanced at the Jet Propulsion Laboratory in Pasadena, California, a technique which can 'improve' the image by comparing adjacent grains electronically so as to remove haziness, but cannot alter shapes or otherwise falsify the record.

A black triangle in one corner of the photograph is caused by the edge of the strobe flash apparatus, and should be disregarded. The pictures show a flattened, diamond-shaped fin, flipper or paddle, in which the limb structure is not quite central. Calculations from optical data corroborated by simultaneous sonar recordings suggest that the paddle is about 2 m long. Given its function, the 'main spar' of the paddle is likely to be nearer the leading, rather than the trailing edge, suggesting that it is a right-sided paddle.

A neck would be likely anterior to a forelimb, and a wider body posterior to it; since the opposite appears to be the case the photographs are assumed to show a right hind limb. The strobe

light illuminates an area of the animal's back and belly with a rough skin-texture. In the upper photograph there is what may be some suggestion of ribs.

Although these two photographs of the hind flipper are the main basis of the description, and the flipper-length is thought to be some 2 m, it is possible, using the evidence from other photographs and from sightings, to indicate some further features and dimensions of the animal. A total body length of 15-20 m seems possible including a neck of 3-4 m with a rather small head which may have some horn-like protuberances. Moving-target-discriminating sonar displays have provided body length measurements of the order of 15 m, and the underwater automatic strobe photography has provided support for the reports of a long neck.

Frequent descriptions liken the back to 'an up-turned boat', and both still photographs and films show this configuration. Further underwater photographs taken in June 1975 may show other aspects of the same species, including a view of the head, neck and body (Fig. 3). The Loch Ness monster may possibly resemble the impression shown in Figs 4 and 5.

It is proposed that the large animal species living in Loch Ness be called *Nessiteras rhombopteryx*. Scott and Rines (nov. genus and species; the only species is automatically the type species) with the common names: the Nessie or Loch Ness monster. The generic name *Nessiteras*, a neuter noun, is a composite word combining the name of the Loch with the Greek word *terax*, genitive *teratos*, which was used from Homer onwards to mean a marvel or wonder, and in a concrete sense for a range of monsters which aroused awe, amazement and often fear. The specific name *rhombopteryx* is a combination of the Greek *rhombo*, a diamond or lozenge shape, and the Greek *pteryx* meaning a fin or wing. Thus the species is the Ness monster with diamond fin.

In trying to determine which class

Nature Vol. 258 December 11 1975

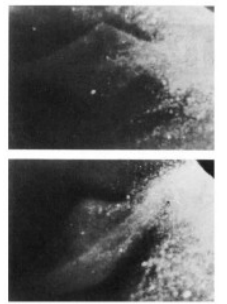

Fig. 1 Photographs taken by strobe flash at a depth of 45 feet in Loch Ness at 0150 h on August 8, 1972, showing the right hind flipper, calculated as about 2 m long, of *Nessiteras rhombopteryx*. The lower picture was taken about 1 min after the upper. The camera was stationary and aimed horizontally. The photographs were taken with equipment devised by Professor Harold Edgerton of the Massachusetts Institute of Technology and have been computer enhanced at the Jet Propulsion Laboratory, Pasadena, California. (Copyright, Academy of Applied Science, Boston, Massachusetts.)



Fig. 2 Sonar trace (Raytheon DE 725 C) of the period when the photographs in Fig. 1 were taken. The sonar set was aimed horizontally, and the strong echoes are at a range of about 40 metres. Sonar frequency 200 kHz. Time marks on the right of the picture are at 5 min intervals. The arrows mark the period during which the photographs were taken. The indications are that two large animals were present.

© 1975 Nature Publishing Group



# Why does it matter? Taxonomic inflation.

- **inflation leads to devaluation**
- tigers (*Panthera tigris*) have been split into two species based on 3 diagnostic bp in the mitochondrial cytochrome *b* (*P. tigris* and *P. sumatrae*) (Cracraft et al. 1998)
- genetic drift of some other populations in India has already led to the fixation of unique haplotypes
- *„The fact that tigers are dwindling towards extinction will thus cause a multitude of new tiger „species“ – before they all vanish“* (Zachos 2016)
- PSC → increase of threatened species – many species will have **low population sizes and distribution ranges (IUCN RED List criteria)** – e.g. US Endangered Species Act – increase from US\$4.6 billion to US\$7.6 billion for full recovery of all species

# Why does it matter? Biodiversity research.

- **species richness is a function of the underlying species concept**
- often comparing „apples and oranges“
- 36 biodiversity hotspots (at least 1500 endemic vascular plants species and 70% of primary vegetation has been destroyed)
- more than US\$1 billion for conservation in biodiversity hotspots

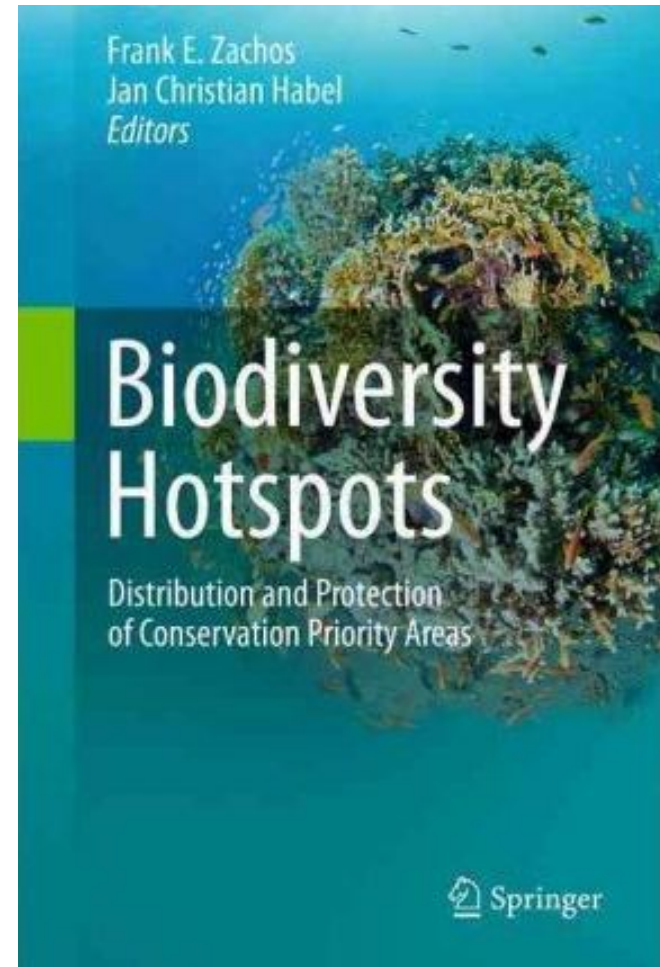

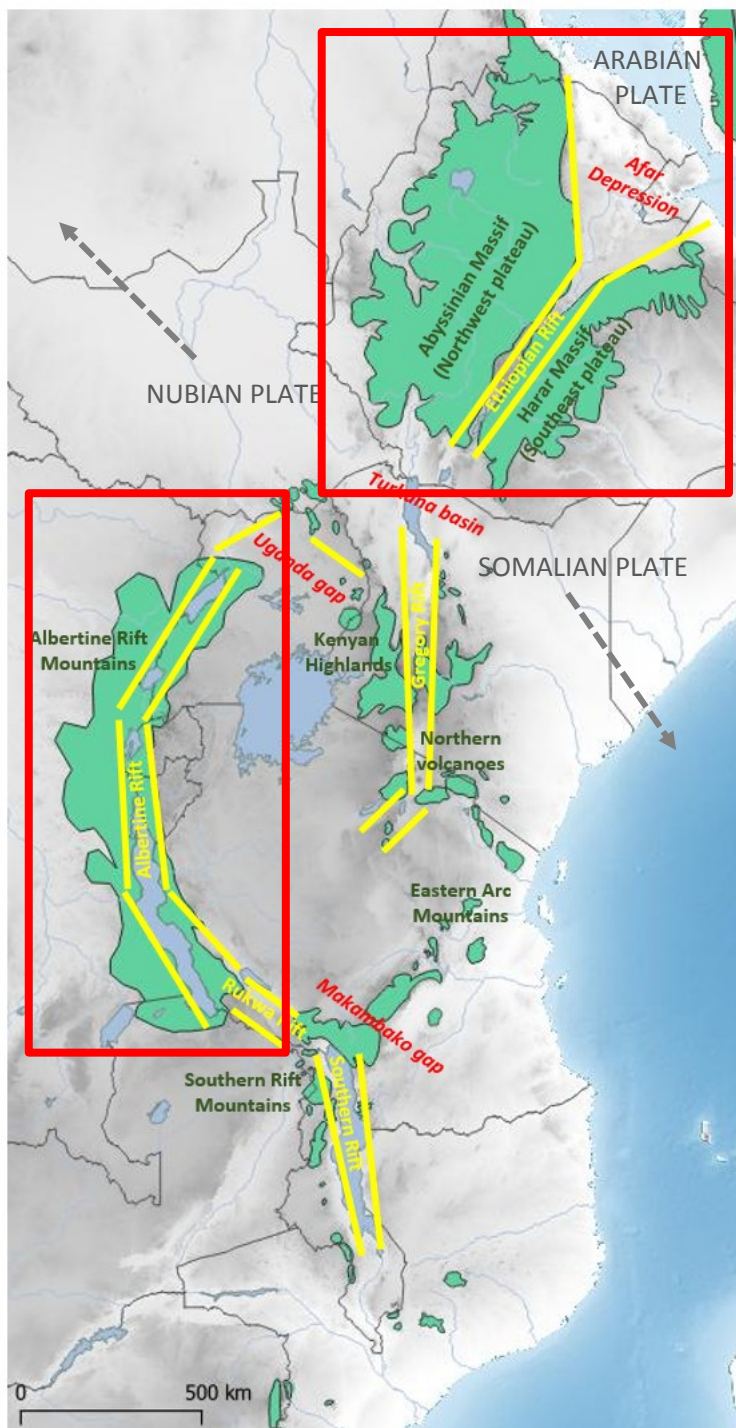

# Eastern Afromontane Biodiversity Hotspot (EABH)

- Albertine Rift – considered as the most diverse part of EABH
- Ethiopian Highlands – the most neglected part of EABH despite the large area and geomorphological diversity
- examples from rodents



# „Ethiopian cradle“

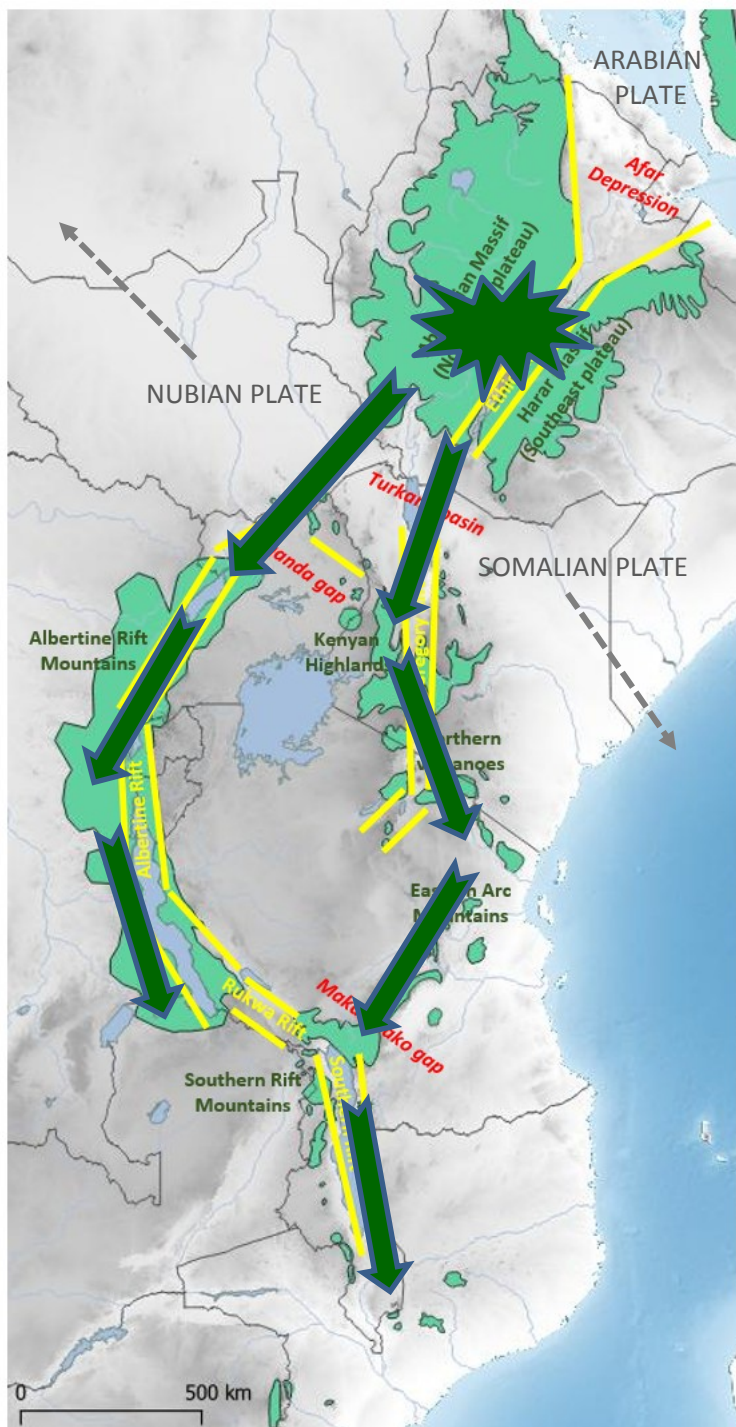

*Mus (Nannomys)*



*Otomys typus*  
group



*Lophuromys*  
*flavopunctatus*  
group



*Tachyoryctes*

e.g. Bryja et al. 2019, Folia Zoologica

# „out of Ethiopia“

root rats (*Tachyoryctes*)

*T. macrocephalus* (ETH)



*T. „splendens“* (1 sp. in Ethiopia, 12 spp. in Kenya and Albertine rift )

- the highest evolutionary diversity in Ethiopia (5 species using PSC)
- a single colonization of Kenyan Highlands and Albertine Rift Mts.



# HOW CAN GENETICS BE HELPFUL IN SPECIES IDENTIFICATION?

## *Vespula maculifrons*

- The Eastern Yellowjacket commonly found across North America
- A highly social wasp, they live in colonies of hundreds to thousands
- They usually nest underground, but can be a pest if they nest too close to a building.

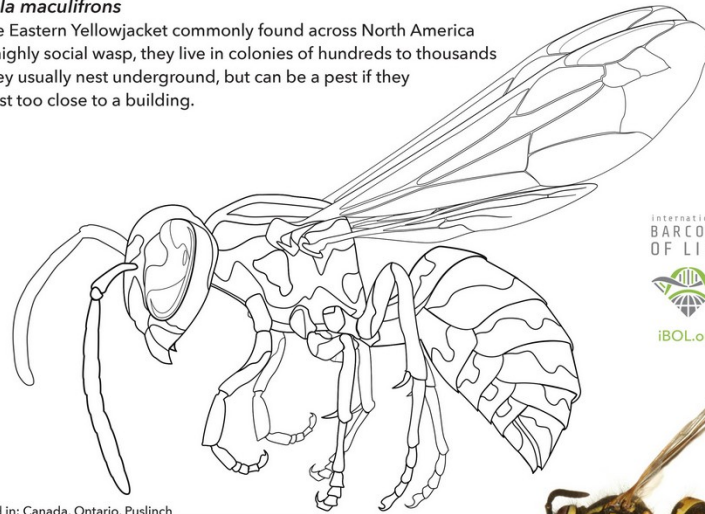

INTERNATIONAL  
BARCODE  
OF LIFE



iBOL.org

Collected in: Canada, Ontario, Puslinch





# Biological identifications through DNA barcodes

Paul D. N. Hebert\*, Alina Cywinska, Shelley L. Ball  
and Jeremy R. deWaard

Department of Zoology, University of Guelph, Guelph, Ontario N1G 2W1, Canada

first idea in 2003

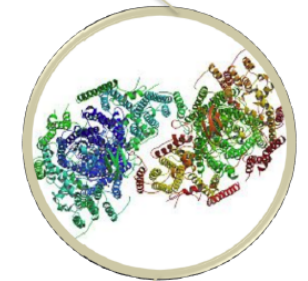
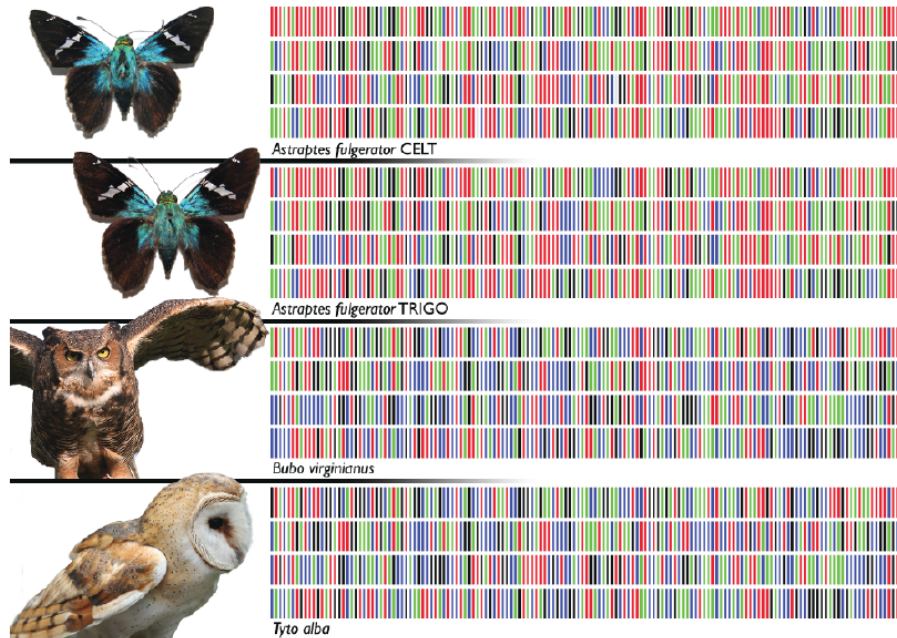
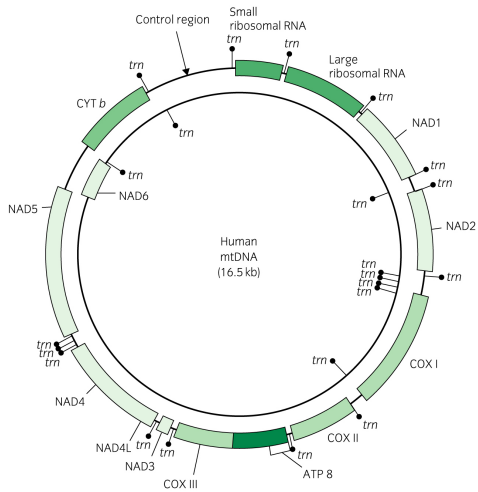

„DNA barcode“ – short fragment of mitochondrial DNA



WE ARE

# illuminating biodiversity

## Why

IS BIODIVERSITY IMPORTANT

## What

IS DNA BARCODING

## How

CAN I GET INVOLVED

## Who

ARE THE IBOL CONSORTIUM MEMBERS

# Why barcode animal and plant species?

Known Biodiversity  
*Approximately 1.7 million named species of plants and animals.*

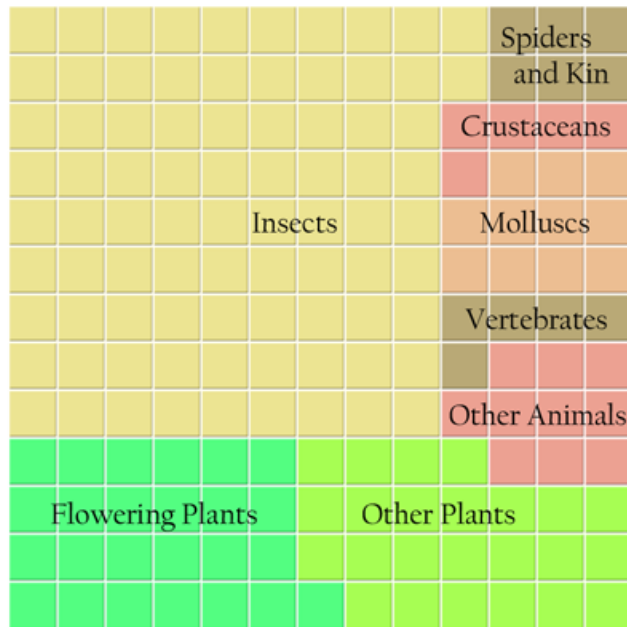

1 square = 10,000 species

Estimated Biodiversity  
*10 million species*

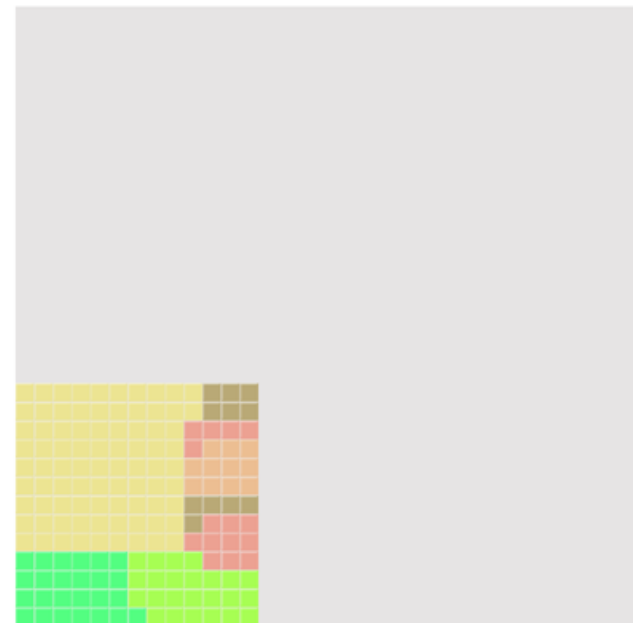



# Crisis of biodiversity and classical taxonomy



DNA barcoding is  
important part of  
„integrative taxonomy“



# Integrative taxonomy

Integr. Taxonomy



Ecology

Genetics

Behavioural Biol.

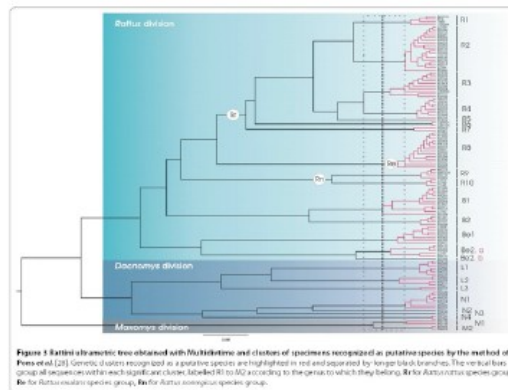
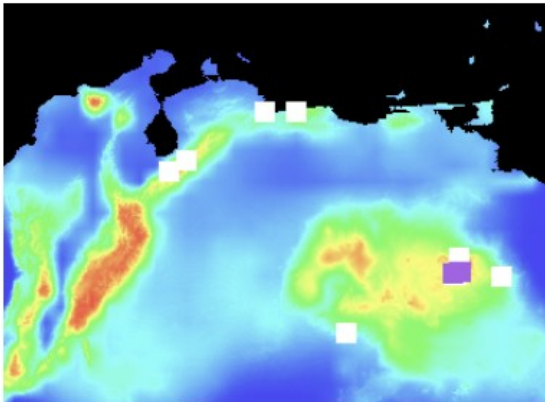
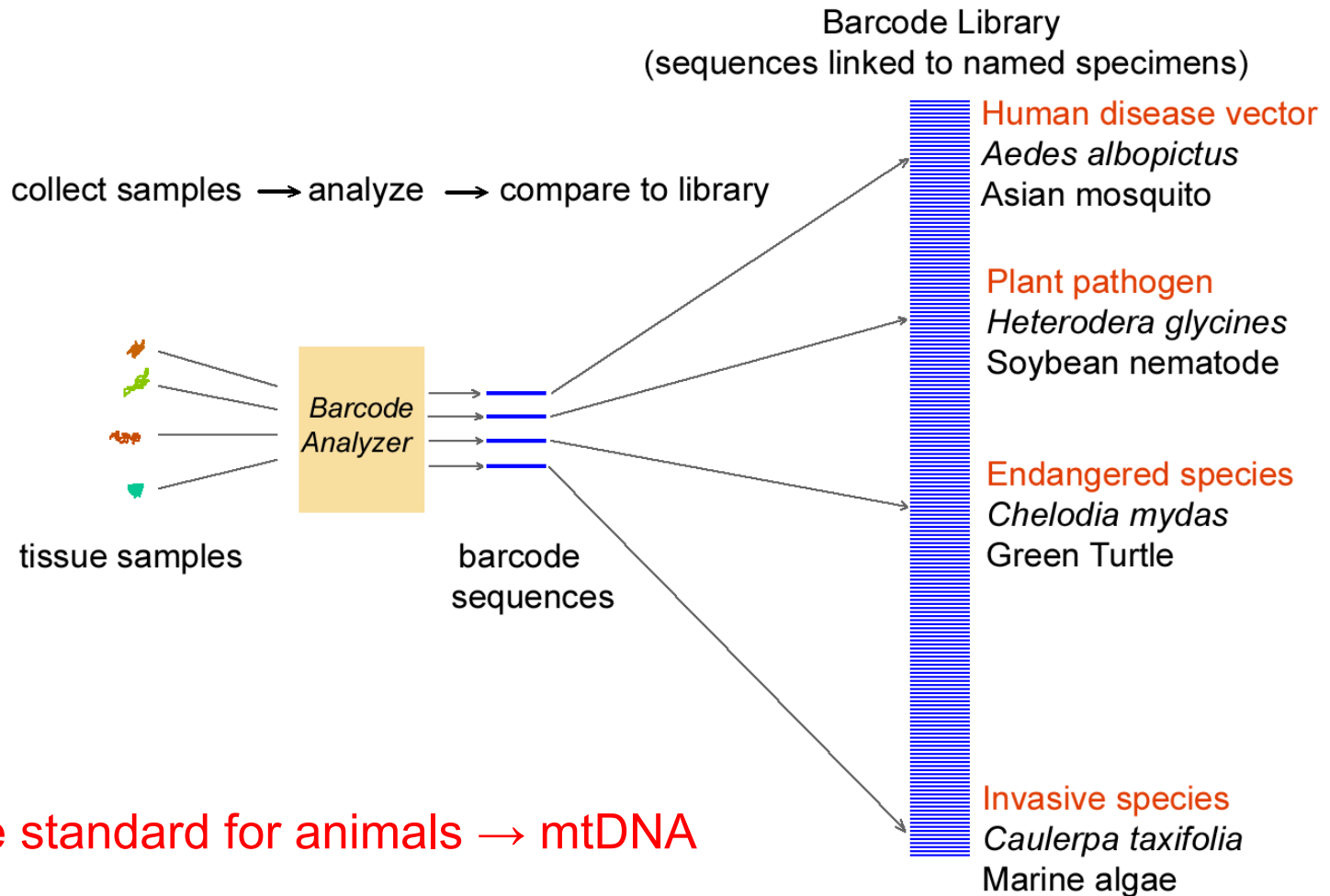

Figure 1. Partial ultrametric tree obtained with MultiState and clusters of specimens recognized as putative species by the method of Pons et al. (21). Genetic clusters recognized as a putative species are highlighted in red and separated by longer black branches. The vertical axis groups all sequences within each putative cluster, labelled R1 to R11 according to the genus to which they belong. R1 for *Robur* species group, R2 for *Daomomya* species group, R3 for *Maxomya* species group.



# What are the benefits of standardization?



Suitable standard for animals → mtDNA

# Why barcode animals with mitochondrial DNA?

Four properties make mitochondrial genomes especially suitable for identifying species

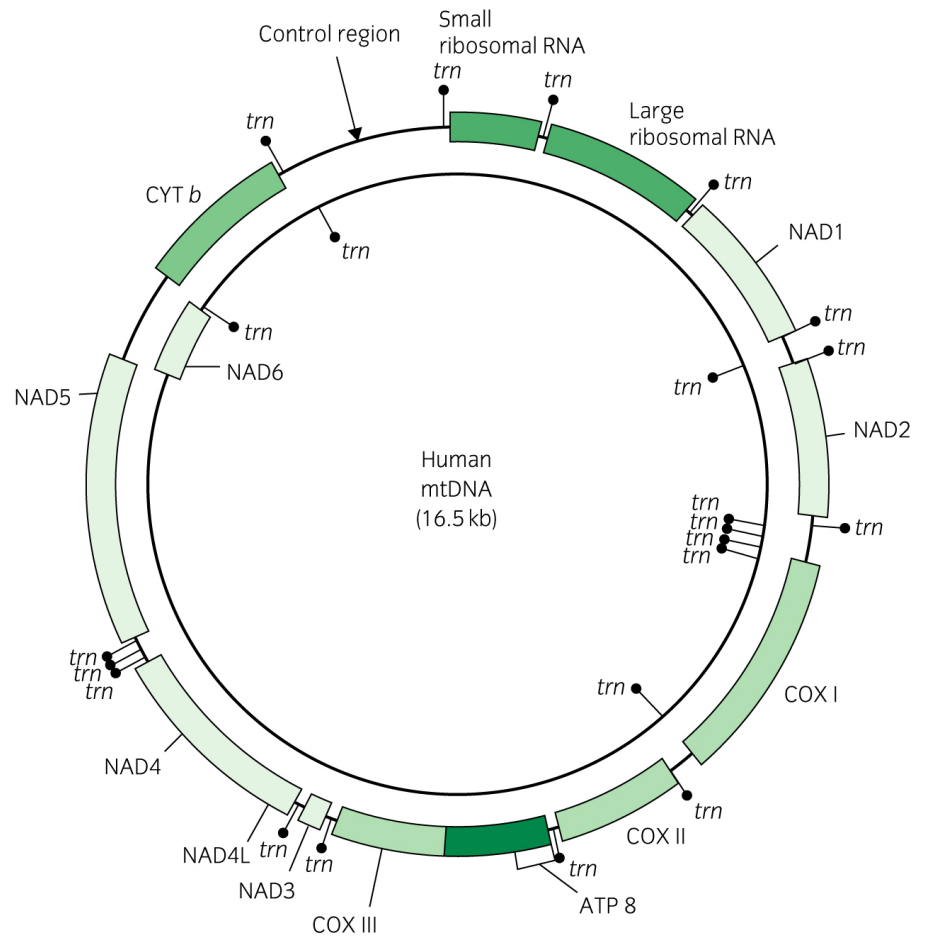

1. **Greater differences among species**, on average 5- to 10-fold higher in mitochondrial than in nuclear genes (lower  $N_e$  for mtDNA). Thus shorter segments distinguish among species, and because shorter, less expensively.

Average sequence differences in nuclear and mitochondrial DNA between human and chimp

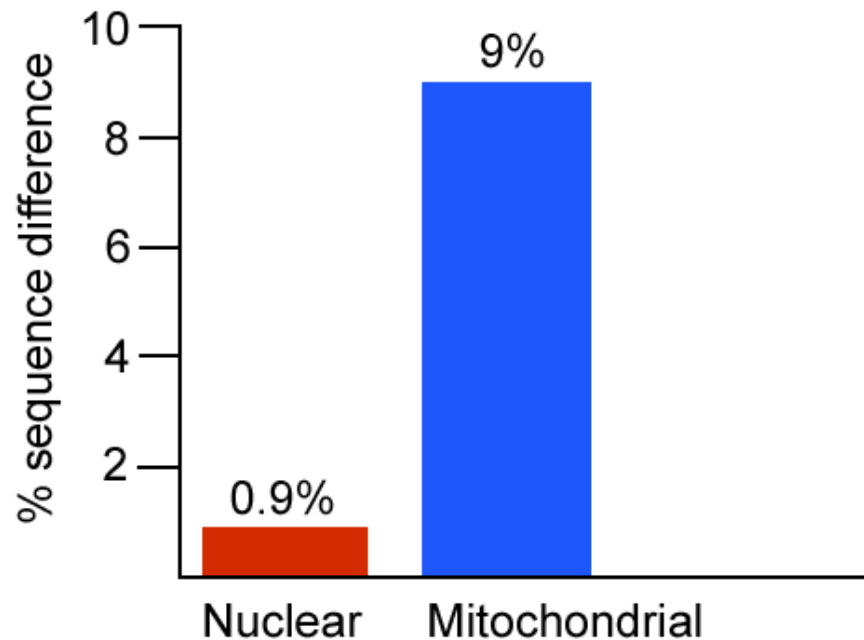



2. **Relatively few differences within species** in most cases. Small intraspecific and large interspecific differences signal distinct genetic boundaries between most species, enabling precise identification with a barcode.

3. **Copy number** There are 100-10,000 more copies of mitochondrial than nuclear DNA per cell, making recovery, especially from small or partially degraded samples, easier and cheaper.

4. **Introns, which are non-coding regions interspersed between coding regions of a gene, are absent from mitochondrial DNA** of most animal species, making amplification straightforward. Nuclear genes are often interrupted by introns, making amplification difficult or unpredictable.

# Barcoding principle

histogram of uncorrected pairwise distances (p-values)

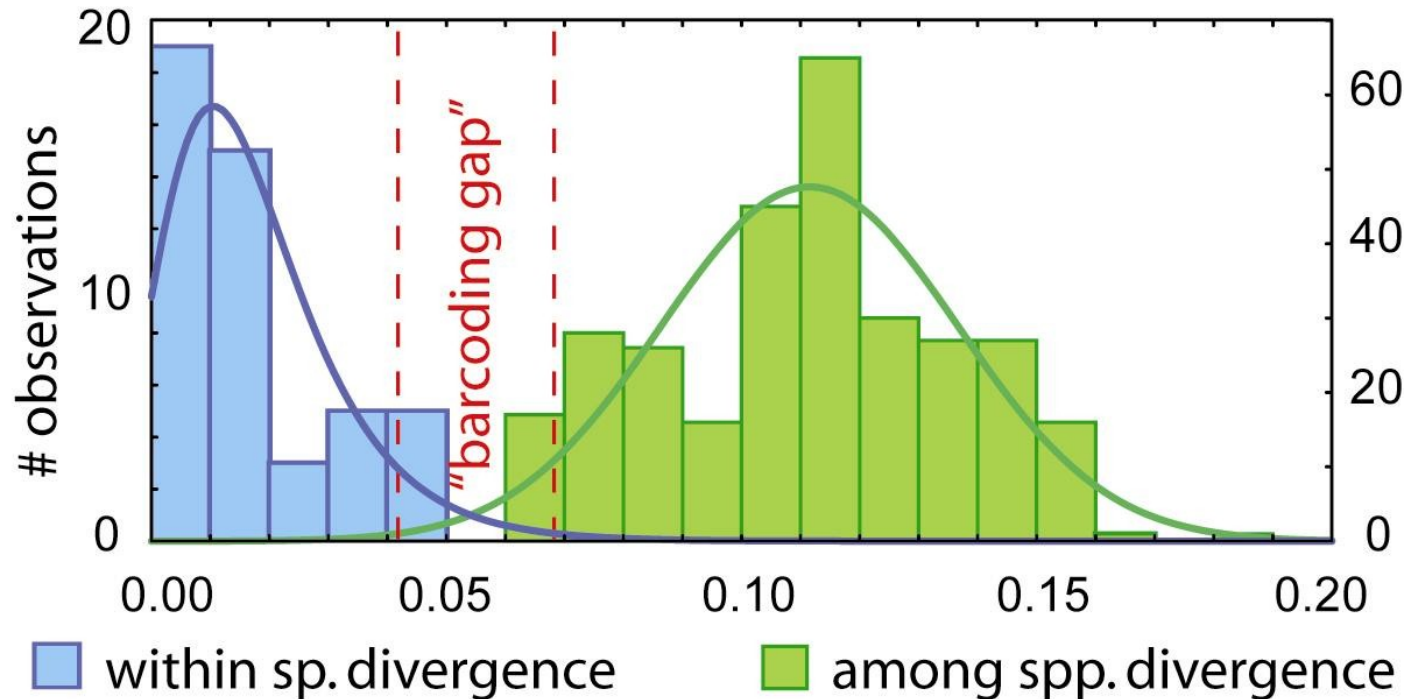

# Barcoding principle

histogram of uncorrected pairwise distances (p-values)

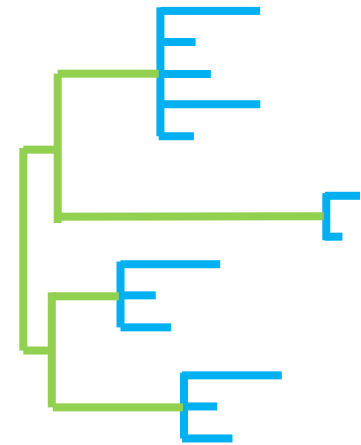
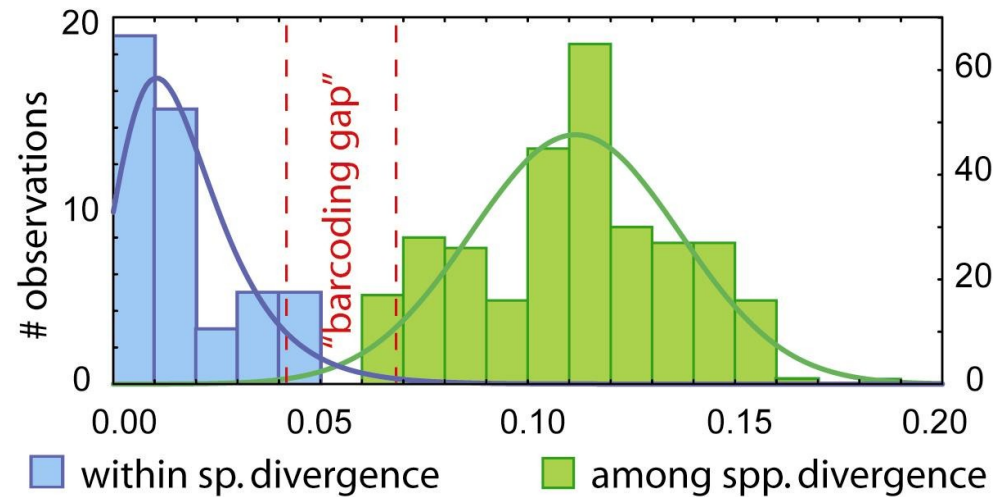

**For animals**, a 658 base-pair fragment of the mitochondrial gene, **cytochrome oxidase subunit I (mtCOI)** – consensus for iBOL consortium

- for particular taxonomic groups, also other barcodes are widely used - e.g. cytochrome *b* for mammals

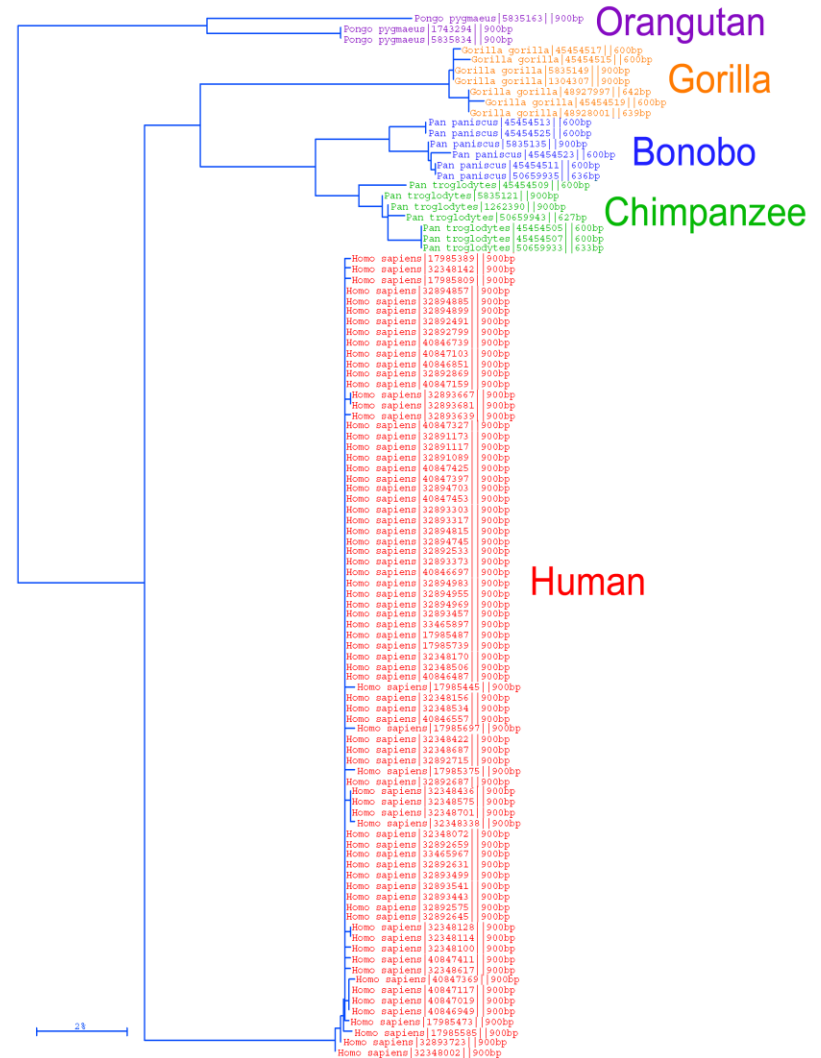

**Barcodes affirm the unity of the species *Homo sapiens***

Comparisons show we differ from one another by only 1 or 2 nucleotides out of 648, while we differ from chimpanzees at 60 locations and gorillas at 70 locations.



# Cytochrome c oxidase I (COI or CoxI) contains differences representative of those in other protein-coding genes

Possible gains in accuracy or cost using a different protein-coding gene would likely be small.

Percent identity plot (PIP) analysis of complete mitochondrial genomes

*Anopheles gambiae*  
vs.  
*A. quadrimaculatus*

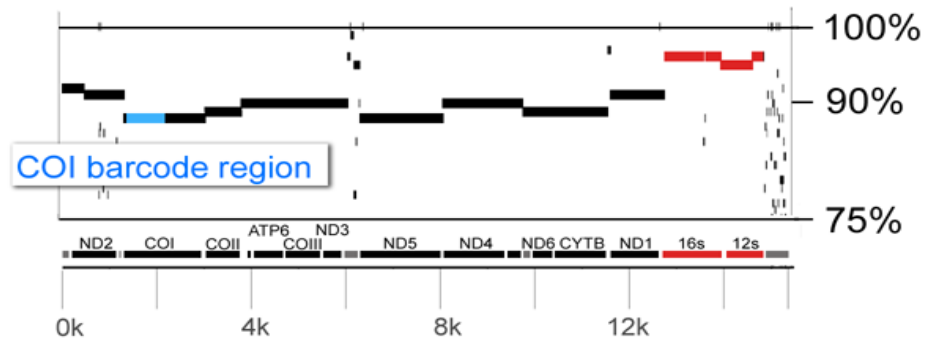

*Homo sapiens*  
vs.  
*Pan troglodytes*

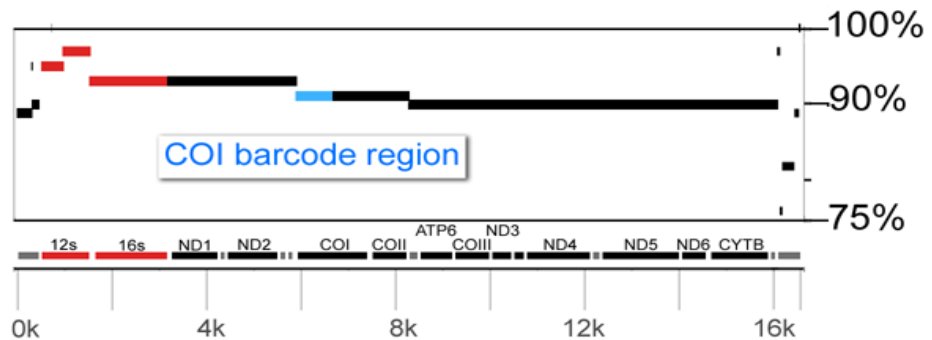

— protein coding gene  
— ribosomal RNA gene

# Focus to date

- **For animals**, a 658 base-pair fragment of the mitochondrial gene, **cytochrome oxidase subunit I** (mtCOI) – consensus for iBOL consortium
- **For plants**, mitochondrial genes do not differ sufficiently to distinguish among closely related species. Promising markers are genes on cpDNA: matK and rbcL
- **For bacteria**, a 16S-rDNA emerges as very useful marker (especially when using next-generation sequencing)

# What do barcode differences among and within animal species studied so far suggest?

- barcodes identify most animal species unambiguously
- approximately 2-5% of recognized species have shared barcodes with closely-related species - many of them hybridize regularly
- in all groups studied so far, distinct barcode clusters with biological co-variation suggest cryptic species

## Interspecific vs. intraspecific COI barcode differences

# Barcoding North American birds

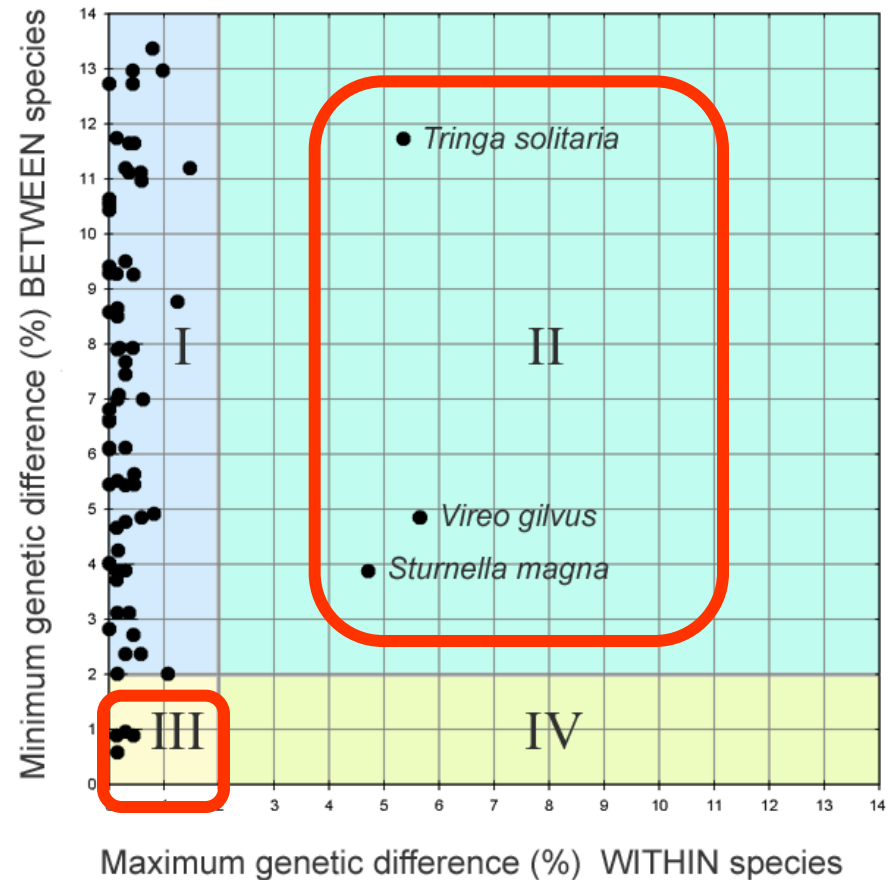

Results for 73 species of North American are shown. Quadrants represent different categories of species:

- I. consistent with current taxonomy
- II. probable lumped species (candidate for taxonomic split)
- III. recent divergence, hybridization, or synonymy.
- IV. probable taxonomic misidentification



## A barcoder?



[Mark Stoeckle](#) The Rockefeller University  
[Paul Waggoner](#) Connecticut Agricultural Experiment Station  
[Jesse Ausubel](#) Alfred P. Sloan Foundation

# Next generation sequencing of amplicons

## 1. Metagenomics

- community of microorganisms
- PCR of 16S (18S) rRNA
- it is also possible to quantify (to some extent)

## 2. Diet composition

- COI barcoding (carnivores)
- chloroplast (cp)DNA (herbivores)

## 3. Analysis of contaminated samples

OPEN ACCESS Freely available online



### Next-Generation Sequencing for Rodent Barcoding: Species Identification from Fresh, Degraded and Environmental Samples

Maxime Galan<sup>1\*</sup>, Marie Pagès<sup>1,2</sup>, Jean-François Cosson<sup>1</sup>

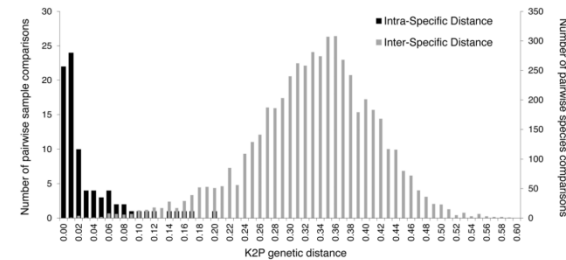

Figure 2. Distribution of pairwise K2P genetic distances within and between 103 rodent species (265 individuals) based on the 136 bp mini-barcode (cvt6).

**|SE|S|AM|E| BARCODE**

**SEquences Seeker & AMPlicons Explorer for Barcoding**

Genotyping and barcoding based on high-throughput multiplex amplicon sequencing

## Illumina sequencers

### Illumina MiSeq

4 millions reads/run  
150 bp/read



### Illumina GAIIx

300 millions reads/run  
150 bp/read



### Illumina HighSeq

1500 – 3000 millions reads/run  
100 bp/read



A barcoder? ... COMING SOON



Mark Stoeckle The Rockefeller University  
Paul Waggoner Connecticut Agricultural Experiment Station  
Jesse Ausubel Alfred P. Sloan Foundation

# Metabarcoding/eDNA

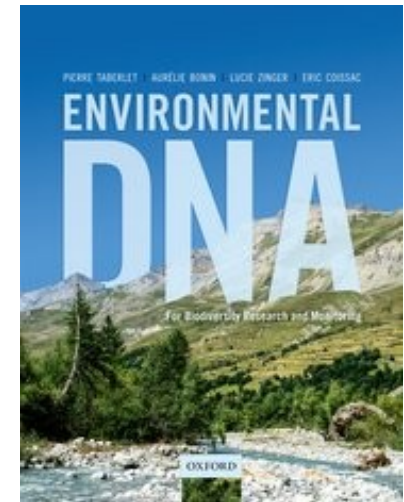
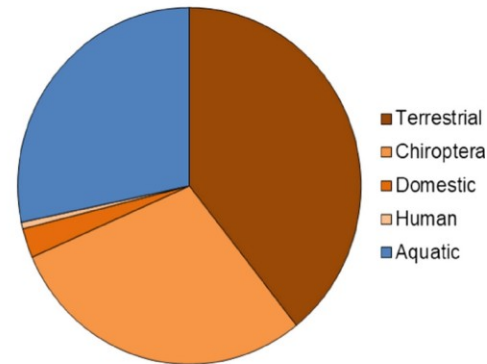
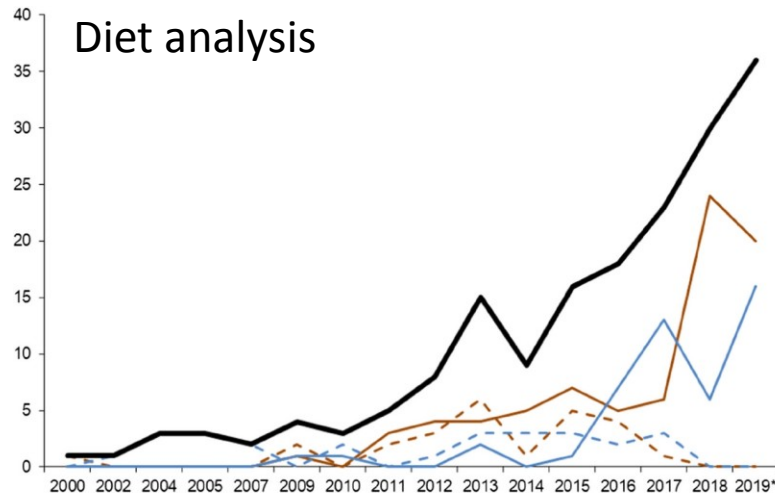

**Bold black line** = Total number of studies per year; *thin straight lines*: high-throughput next-generation sequencing techniques; *thin dashed lines*: Sanger sequencing method or other traditional molecular technique, e.g., RFLP)

- identification of **MOTUs** („molecular operational taxonomic units“)

## What *isn't* DNA Barcoding?





- it is not intended to, in any way, supplant or invalidate existing taxonomic practice
- it is not DNA taxonomy; it does not equate species identity, formally or informally, with a particular DNA sequence
- it is not intended to duplicate or compete with efforts to resolve deep phylogeny (e.g., Assembling the Tree of Life, ATOL)



**DO WE REALLY BARCODE SPECIES?**

mtDNA tree  
(=DNA barcoding)

 *daltoni* - paraphyletic  
 *derooi* - commensal



*Praomys daltoni* complex

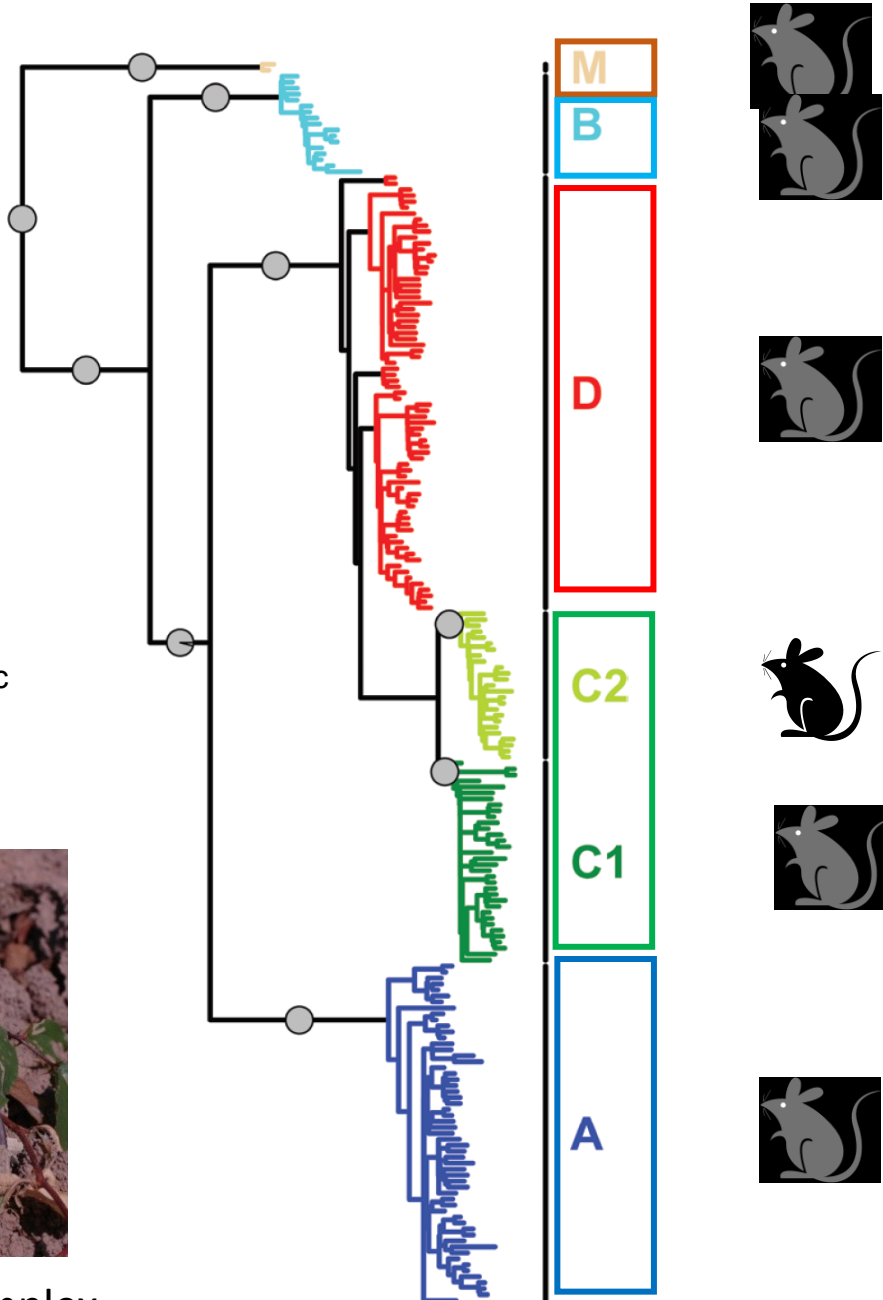

# What is a species?

Five species based on mtDNA barcoding – min. 7% divergence (cyt b)

Two species based on phenotype?

# Phylogeographic structure at mtDNA

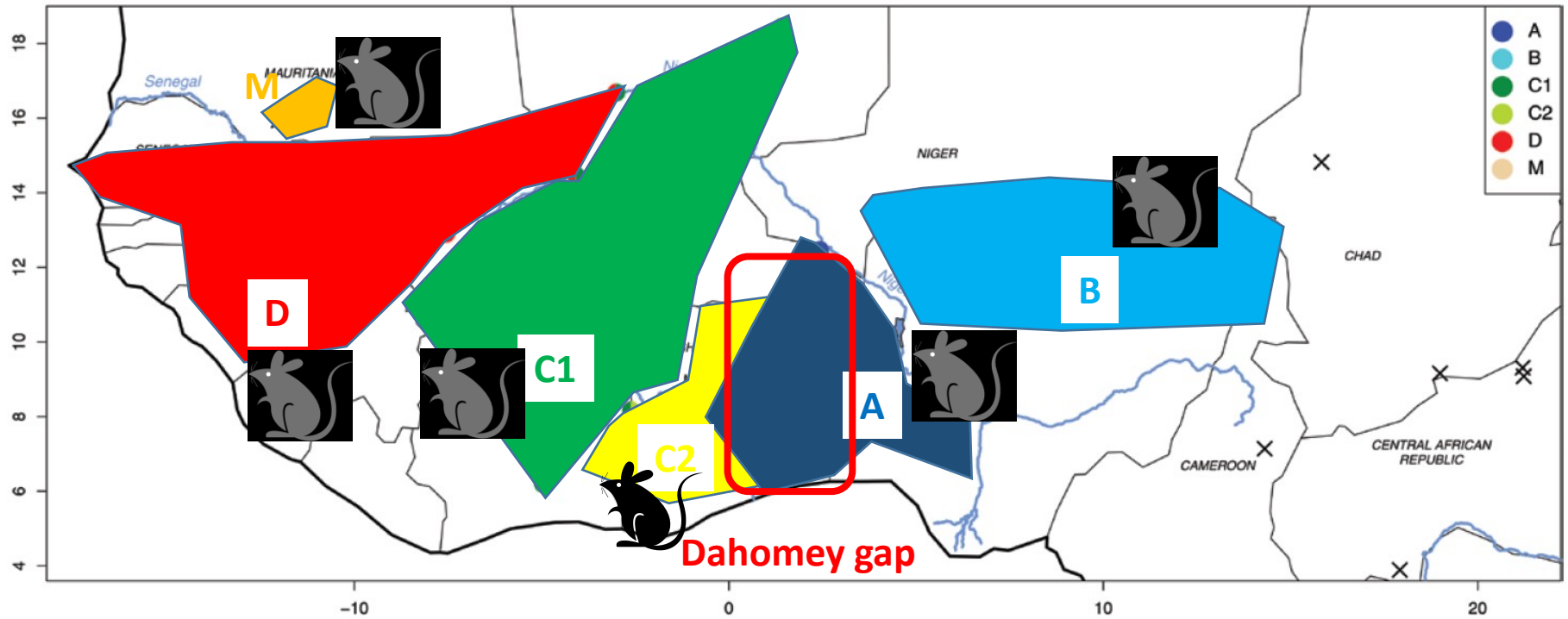

# Partial mtDNA introgression in Dahomey gap

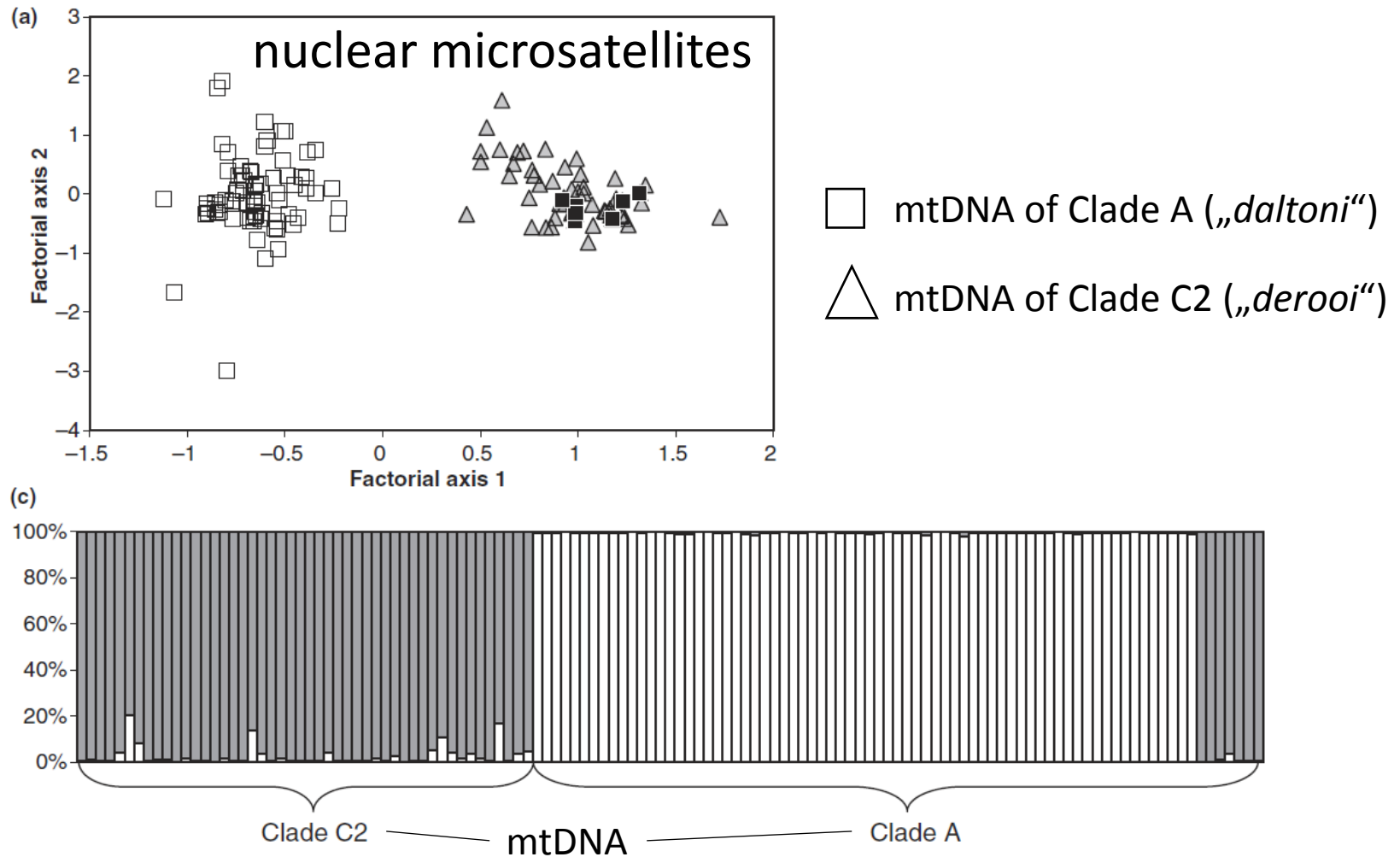

# Morphological differentiation

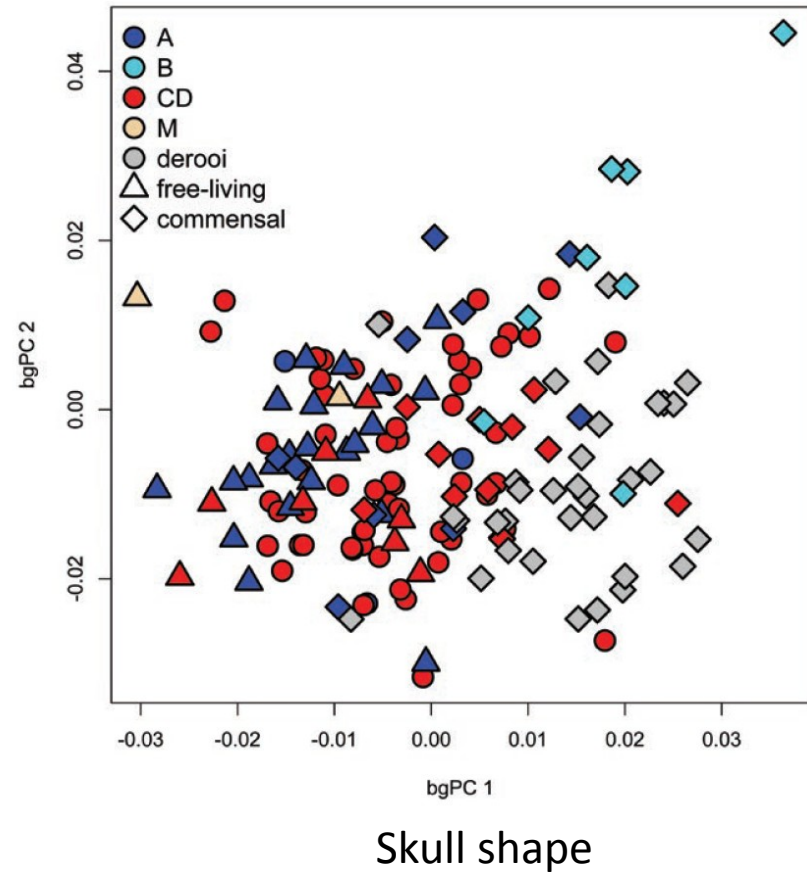
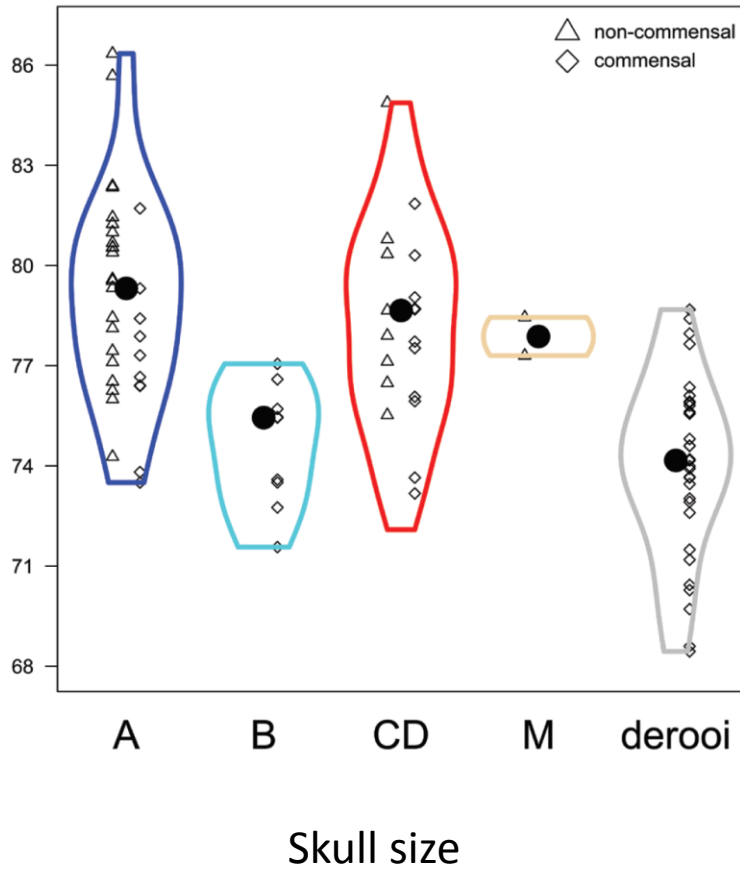



# What is a species?

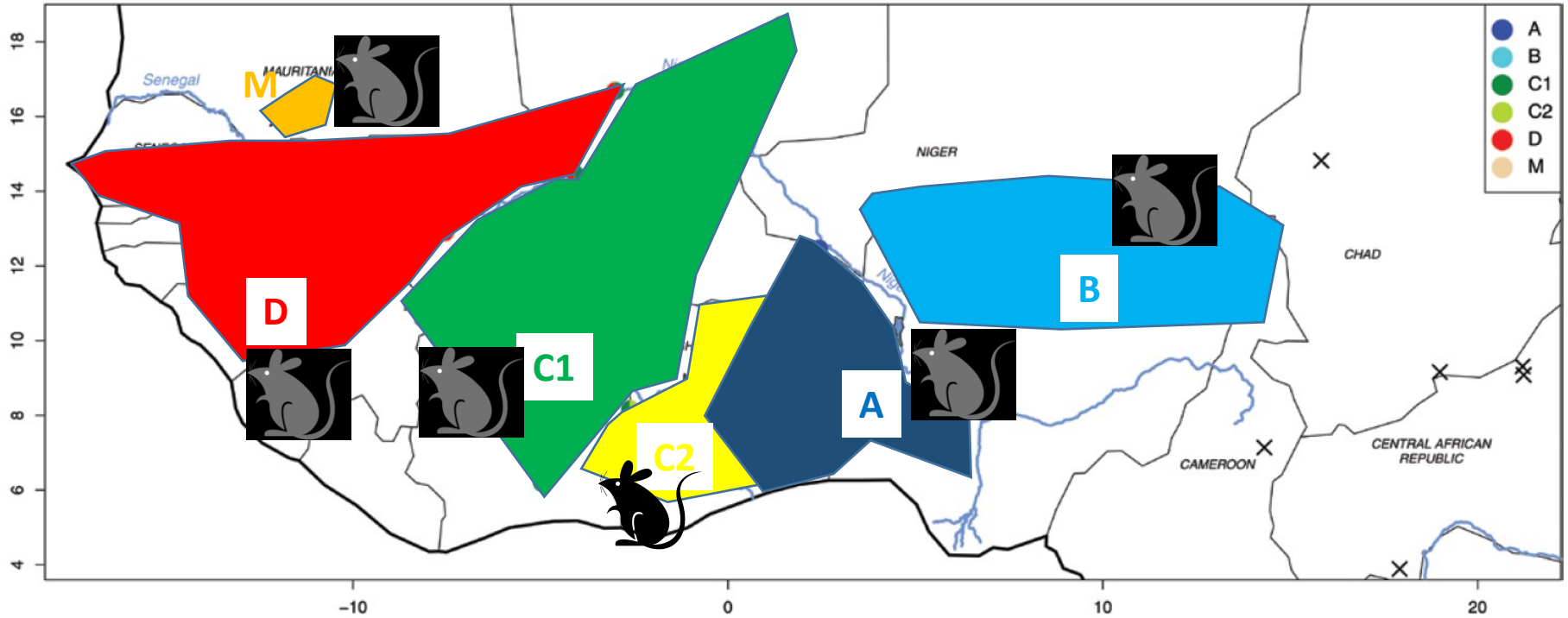

# Morphology and ecology

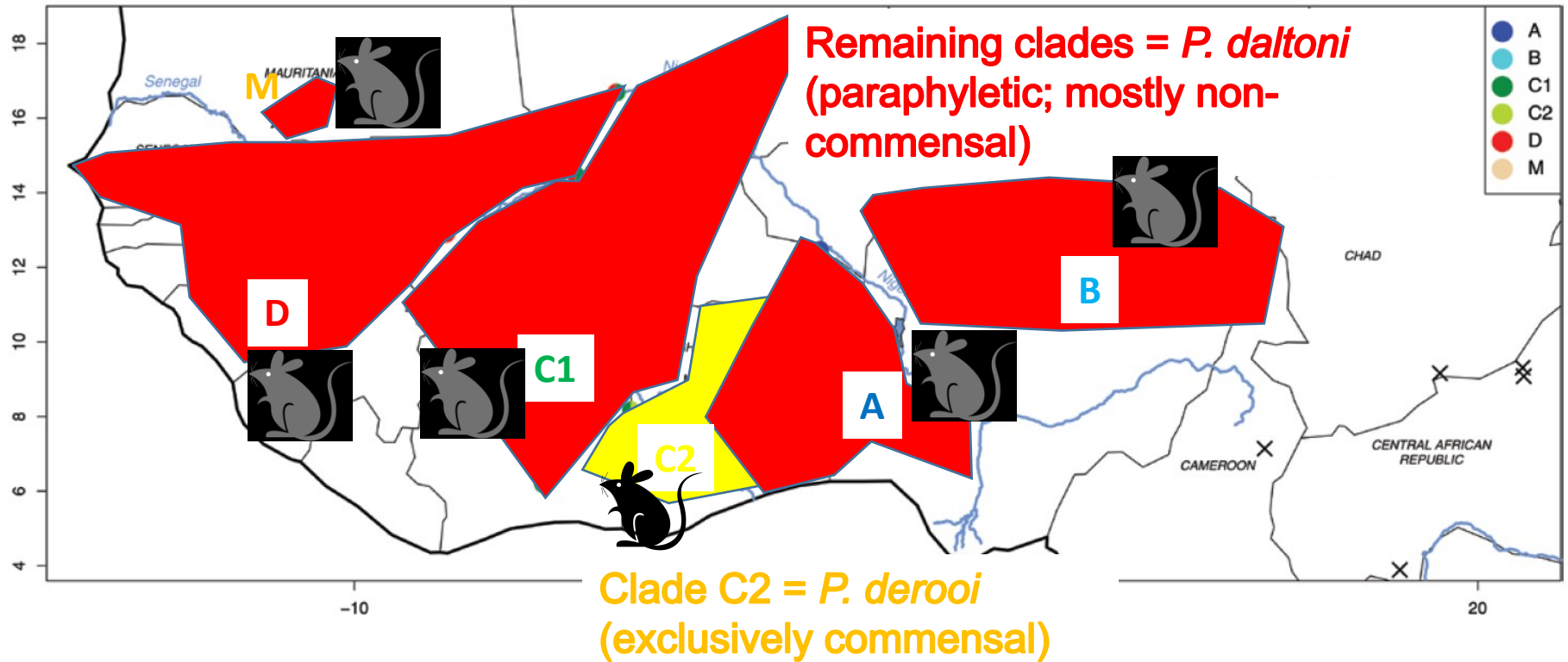

# Karyotypes

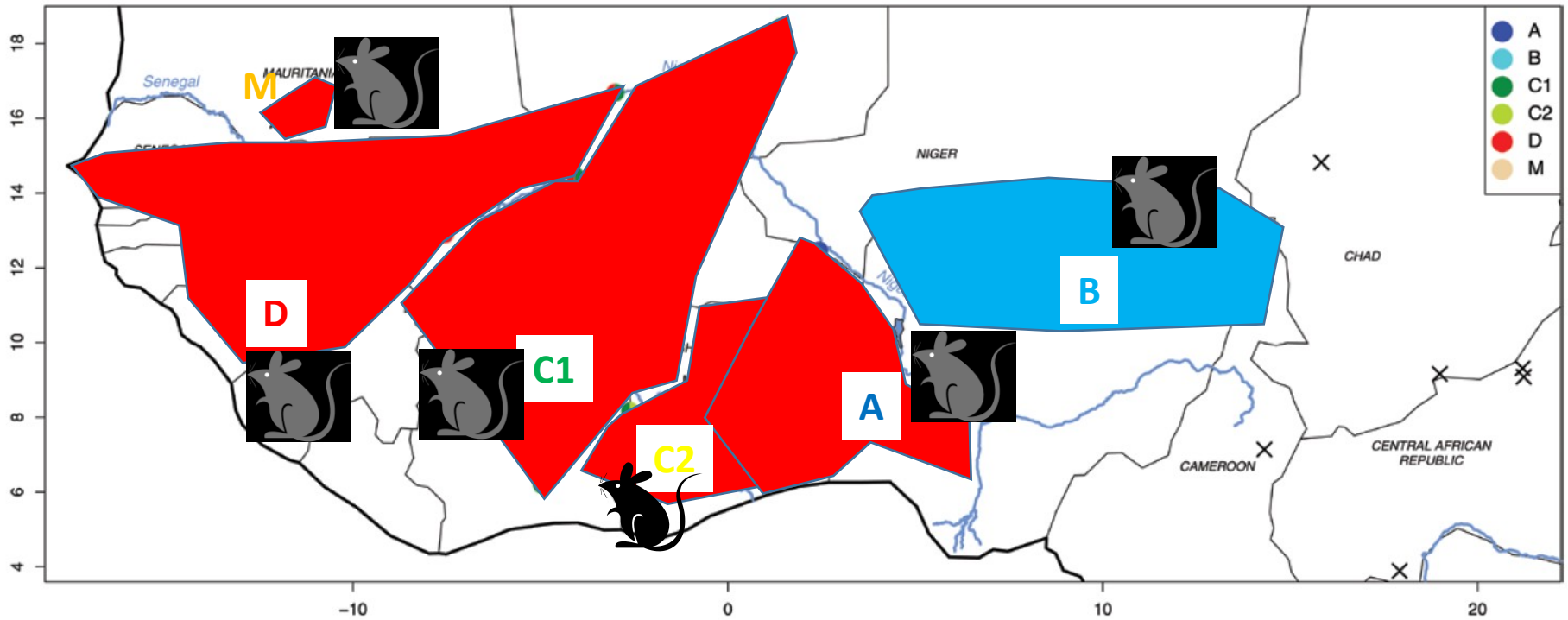

**2 species**

# MtDNA phylogeny + microsatellites + karyotypes

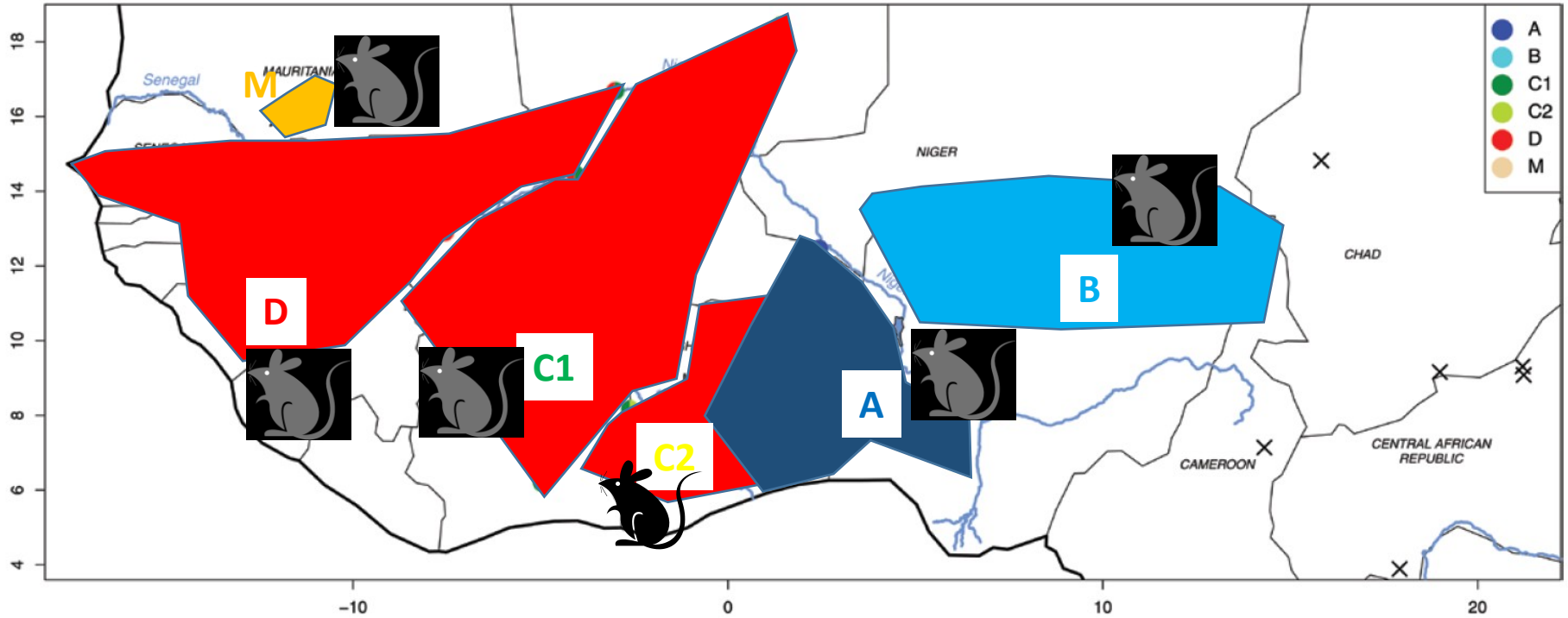

**4 species**

# Phylogenetic species concept – splitting approach

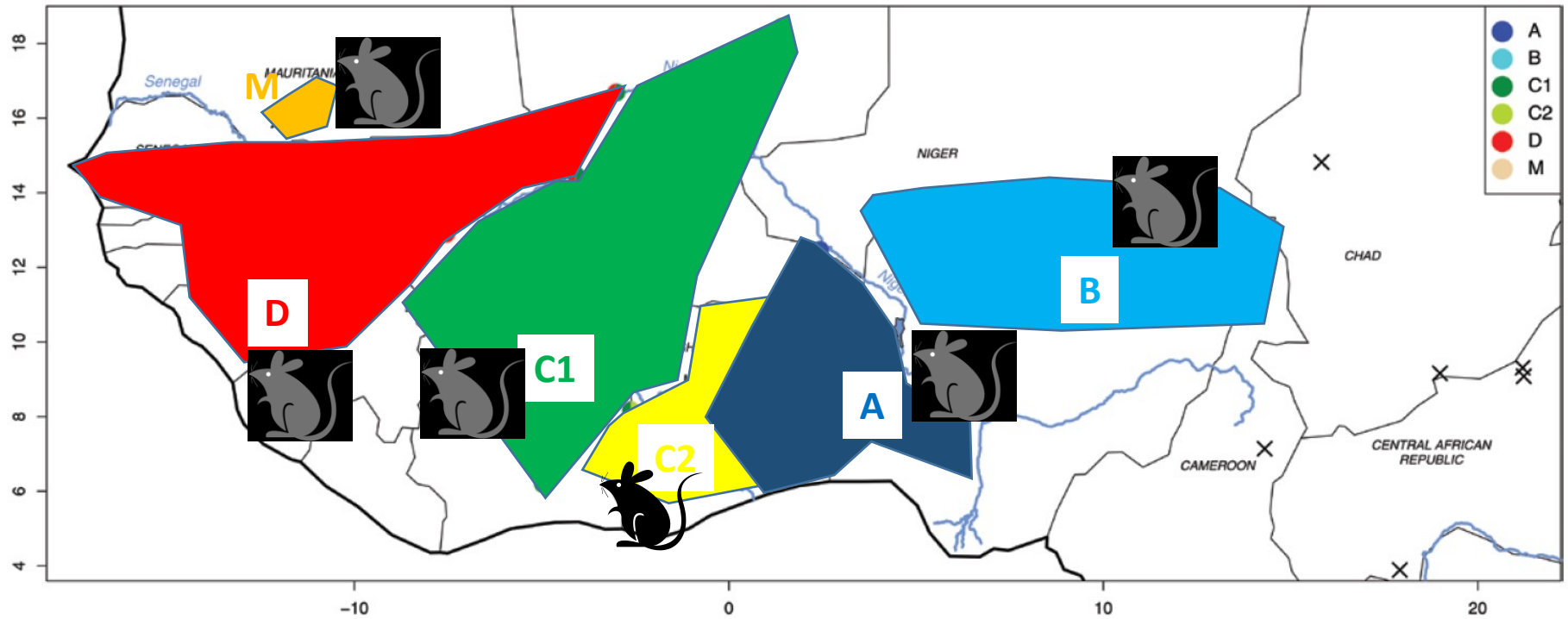

**6 species**



# What is a species

It is really laughable to see what different ideas are prominent in various naturalists minds, when they speak of „species“; ... It all comes, I believe, from trying to define the indefinable.

*Darwin 1856*

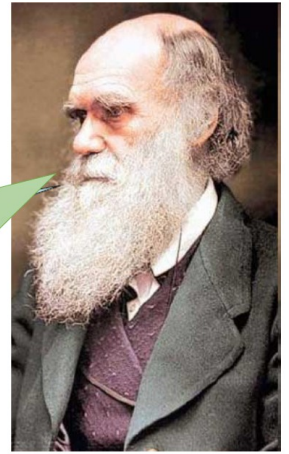

*„A fundamental difficulty facing biologists interested in genetic delimitation of species is that in order to delimit species **they must first be defined**. Species definitions intermingle with species concepts and the **lack of consensus in this field poses a serious dilemma** for the „delimiters“. **If systematists cannot agree on what defines a species, how can geneticists possibly develop objective methods to identify one?**“*

Bruce Rannala, Current Zoology 2015

What are the main limits to barcoding encountered so far?

# What are the main limits to barcoding encountered so far?

- 1) horizontal gene transfer
- 2) nuclear pseudogenes
- 3) heteroplasmy (paternal leakage)
- 4) gene tree vs. species tree
- 5) hybrids – mtDNA introgression

# 1. Horizontal gene transfer

## DNA barcoding cannot reliably identify species of the blowfly genus *Protophthora* (Diptera: Calliphoridae)

T.L Whitworth, R.D Dawson, H Magalon and E Baudry

*Proc. R. Soc. B* 2007 **274**, doi: 10.1098/rspb.2007.0062, published 22 July 2007

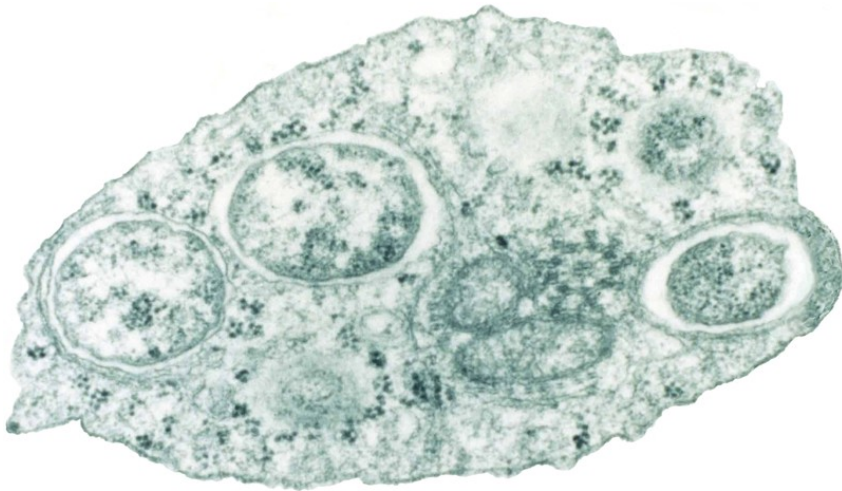

*Wolbachia* within an insect cell  
(25-70% species of insects)

# Results of nuclear and mitochondrial DNA do not match

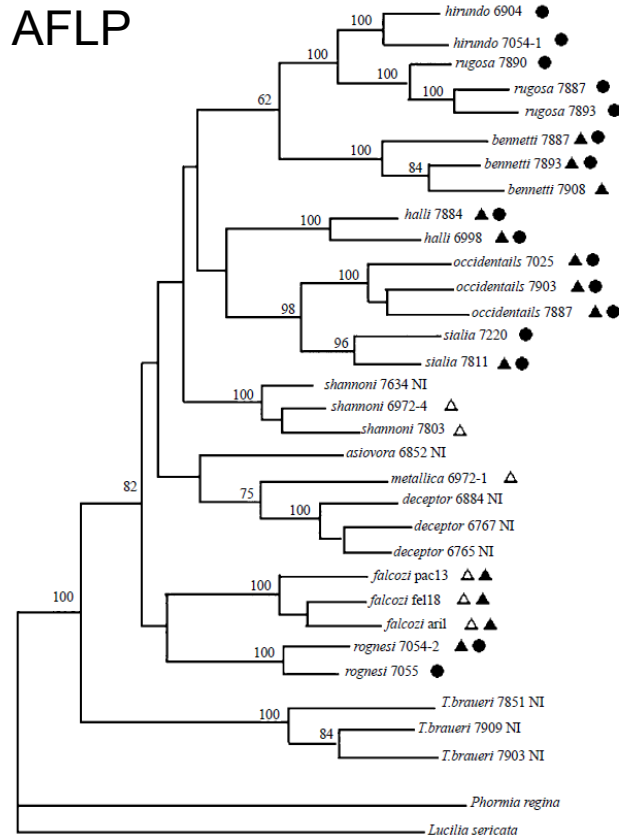

Figure 1. Phylogram of the *Protocaliphora* genus based upon AFLP data. The tree was generated by parsimony analysis using a heuristic search with tree bisection-reconnection. Bootstrap values are shown as percentage of 1000 replicates at each node only if they are 50% or greater. The *Wolbachia* infection status of each individual is shown on the tree. Individuals infected with *wA1*, *wA2* or *wB* *Wolbachia* strains are respectively represented by an open triangle, a solid triangle and a circle. Non-infected individuals are symbolized by NI.

Symbols correspond to the type of *Wolbachia* infection

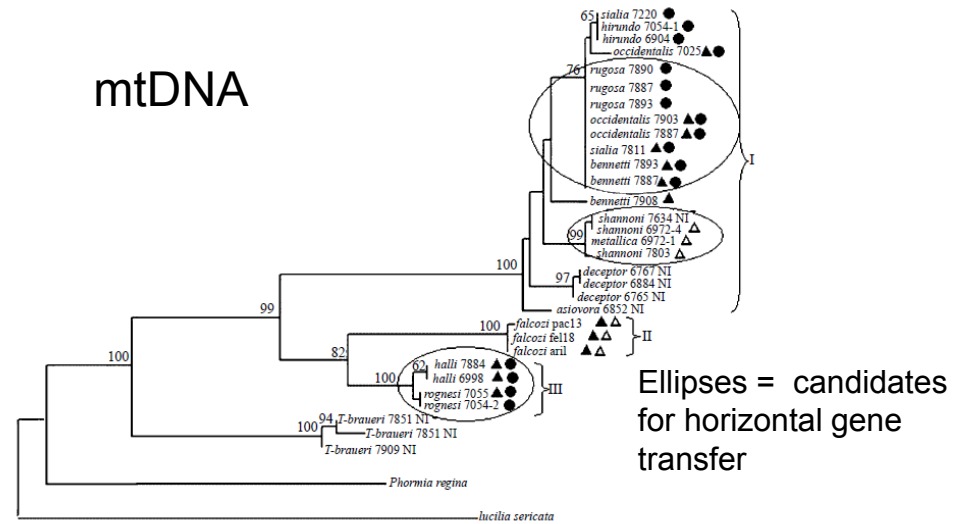

Figure 2. Phylogram of the *Protocaliphora* genus based upon COI and COII data (total of 953 bp). The tree was generated by maximum likelihood analysis using a heuristic search with tree bisection-reconnection. Bootstrap values are shown as percentage of 1000 replicates at each node only if they are 50% or greater. The *Wolbachia* infection status of each individual is shown on the tree. Individuals infected with *wA1*, *wA2* or *wB* *Wolbachia* strains are respectively represented by an open triangle, a solid triangle and a circle. Non-infected individuals are symbolized by NI. Three clusters defined using 3 or 1.8% divergence as threshold values (§3) are shown on the figure. The three ellipses indicate cases where horizontal transfer of *Wolbachia* between species seems probable (§3).

Horizontal transfer of mtDNA through *Wolbachia* (among closely related species, at the level of genera the barcoding is OK)



# 2. Pseudogenes

Molecular Phylogenetics and Evolution 50 (2009) 633–641

Contents lists available at ScienceDirect

Molecular Phylogenetics and Evolution

journal homepage: www.elsevier.com/locate/ympev



False phylogenies on wood mice due to cryptic cytochrome-*b* pseudogene

Sylvain Dubey<sup>a\*</sup>, Johan Michaux<sup>b</sup>, Harald Brünner<sup>c</sup>, Rainer Hutterer<sup>d</sup>, Peter Vogel<sup>e</sup>

Chimeric sequence

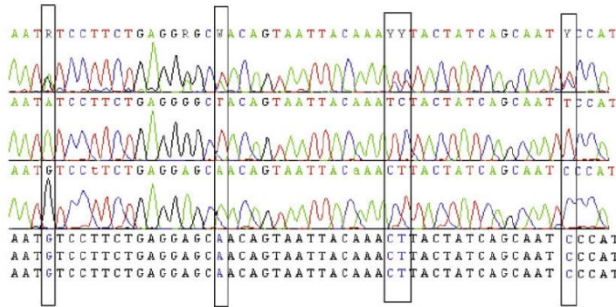

Cytochrome b sequence

Pseudogene sequence

Pseudogene sequence references

Fig. 2. Examples of electropherograms of a chimeric *cyt-b* sequence of lineage V/VII (VI) and of pure lineages V and VII.

Heterozygotes in mtDNA → be careful!

**NUMTS** = „**n**uclear copy of **mt**DNA **s**equences

Relatively often for cytochrome *b*



Mus musculus | Out group

# How to recognize numt?

- ultracentrifugation (fresh samples required)
- the use of tissues with high proportion of mitochondria (e.g. muscles)
- *long-range PCR* (or sequence complete mtDNA)
- RT-PCR (pseudogenes are not transcribed)
- indels, stop codons
- cloning

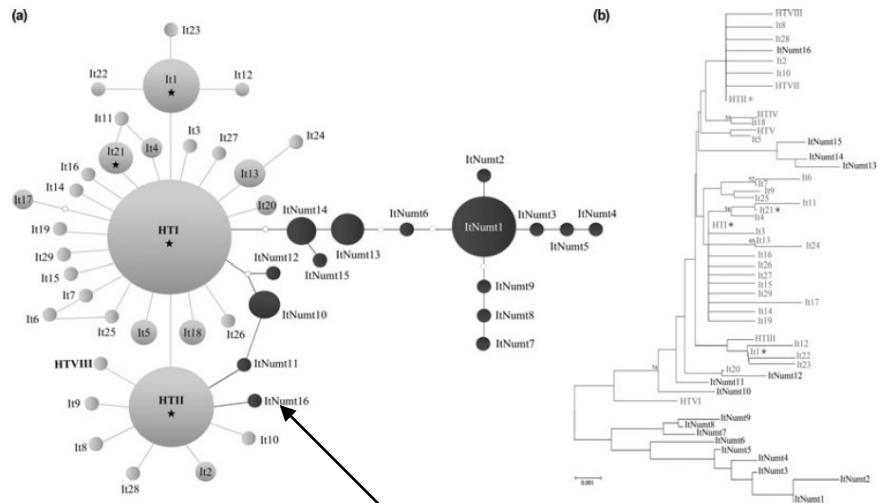
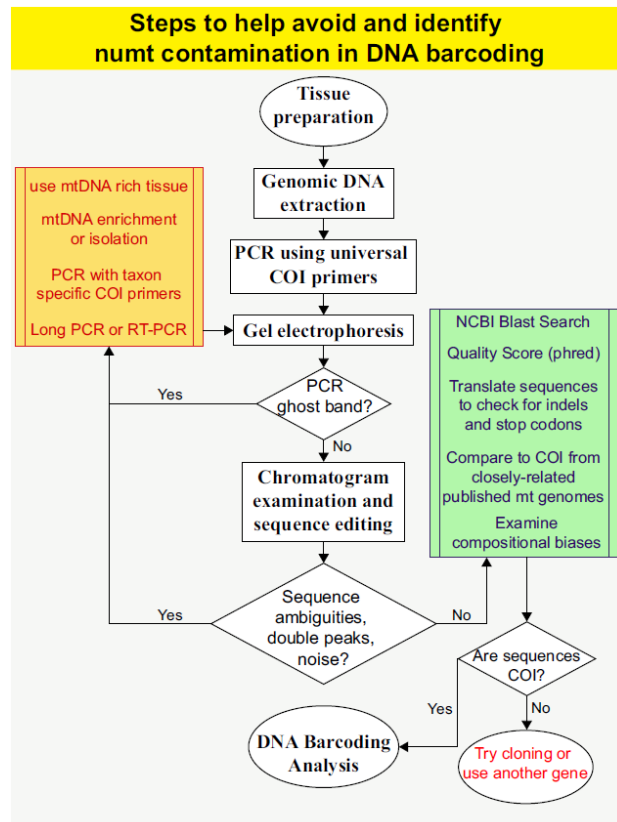

cryptic numts

# Many species in one: DNA barcoding overestimates the number of species when nuclear mitochondrial pseudogenes are coamplified

Hojun Song<sup>\*,†</sup>, Jennifer E. Buhay<sup>\*,†</sup>, Michael F. Whiting<sup>\*</sup>, and Keith A. Crandall<sup>\*</sup>

<sup>\*</sup>Department of Biology, Brigham Young University, Provo, UT 84602; and <sup>†</sup>Belle W. Baruch Institute for Marine Sciences, University of South Carolina, Columbia, SC 29208

Edited by W. Ford Doolittle, Dalhousie University, Halifax, NS, Canada, and approved July 14, 2008 (received for review March 28, 2008)



## A Grasshoppers

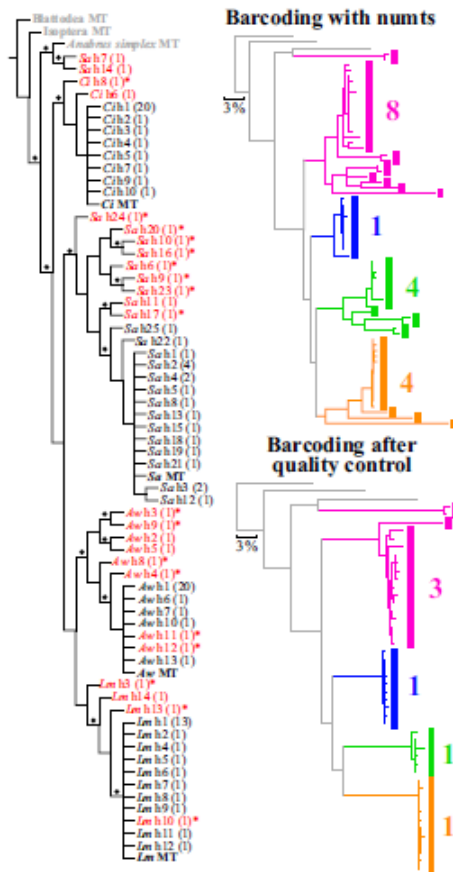

## B Crayfish

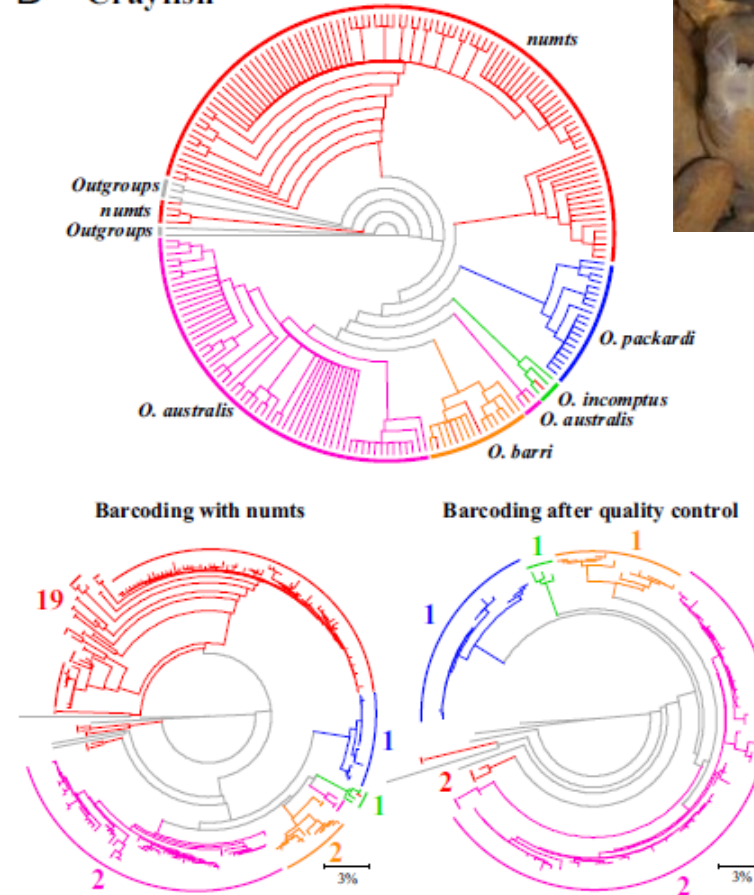

number of suggested barcoded taxa based on 3% divergence on COI with/without numts (identified by stop-codons and indels)

# 3. Heteroplasmy

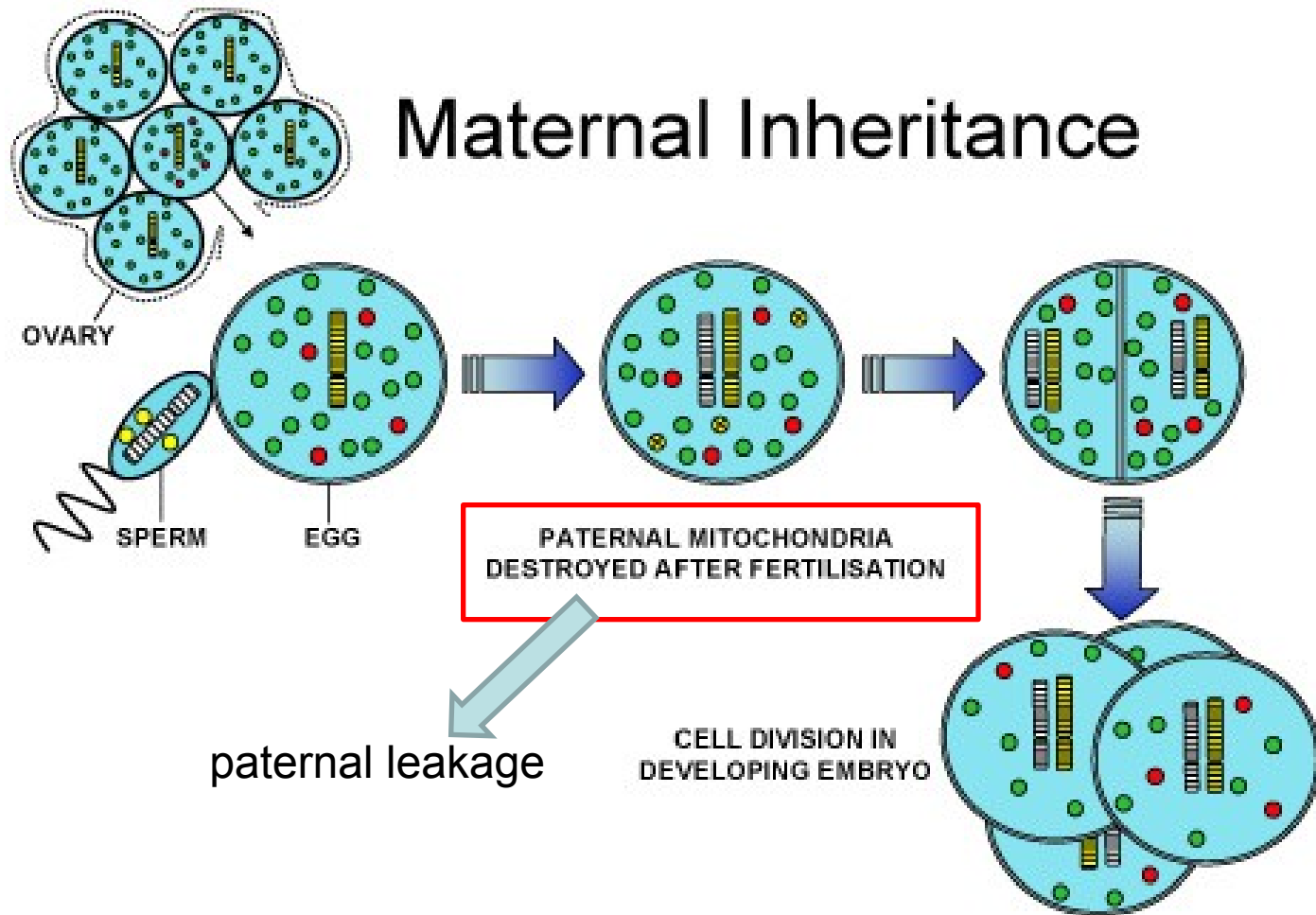

- well studied mitochondrial disorders in human
- low  $N_e$  of mtDNA → usually fast fixation of new mutations – mitochondrial bottleneck

# Paternal leakage

## Extensive paternal mtDNA leakage in natural populations of *Drosophila melanogaster*

MARIA D. S. NUNES,† MARLIES DOLEZAL and CHRISTIAN SCHLÖTTERER  
*Institut für Populationsgenetik, Vetmeduni Vienna, Veterinärplatz 1, A-1210 Vienna, Austria*

- allele-specific real-time quantitative PCR (RT-qPCR) → heteroplasmie je asi častý jev
- 14 % jedinců, ale velmi nízká frekvence druhého haplotypu
- paternal leakage 6 %

- mtDNA transmission from both parents occurs regularly in certain bivalves (Bivalvia)



## **4. GENE TREES VS. SPECIES TREES**

**STATISTICAL MULTI-LOCUS SPECIES  
DELIMITATION**



# Allopatric speciation model

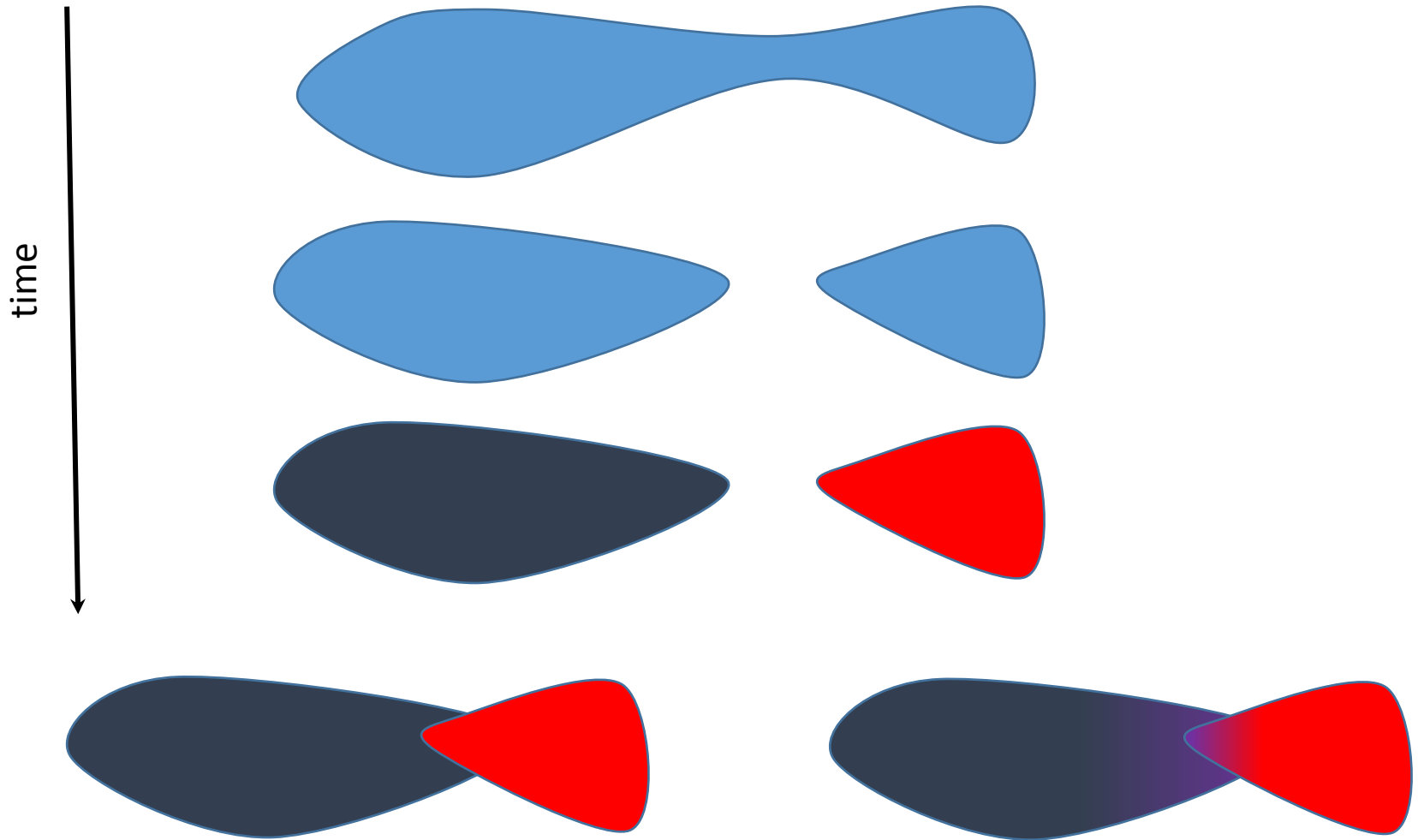

# Dobzhansky-Muller incompatibility

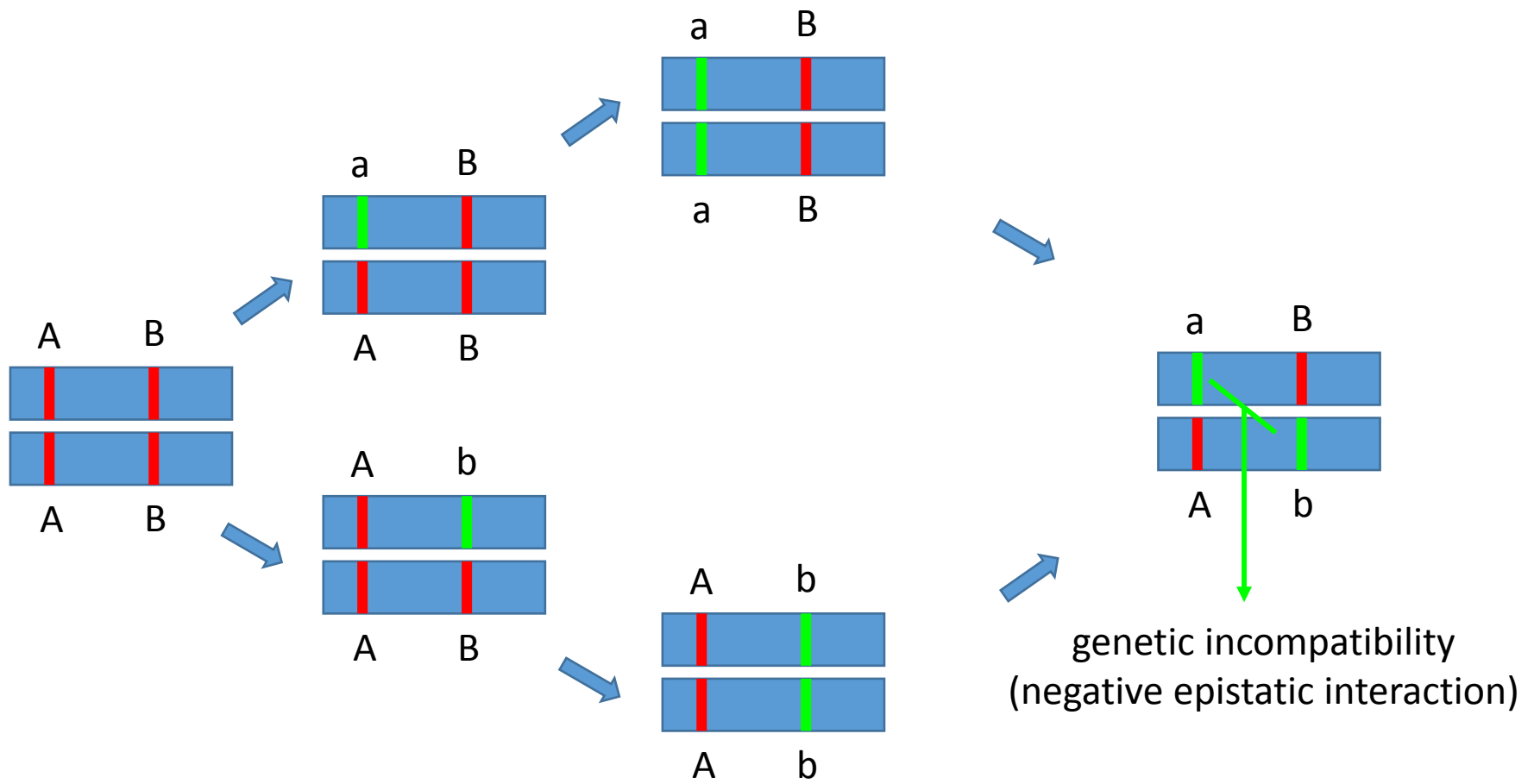

# Phylogeny at the level of populations and species

Species are metapopulation lineages > new methods for DNA-based species delimitation

## Gene trees

- Vital to understanding the process of speciation
- Span **intraspecific** and **interspecific** evolution

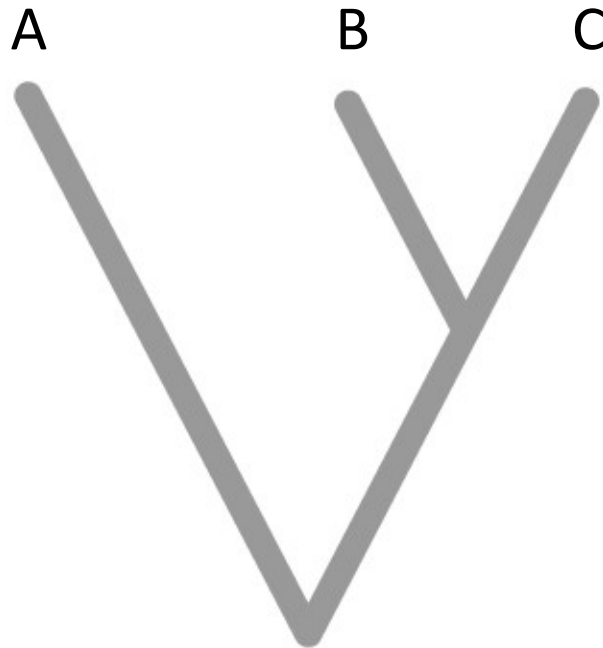

Species phylogeny

>>

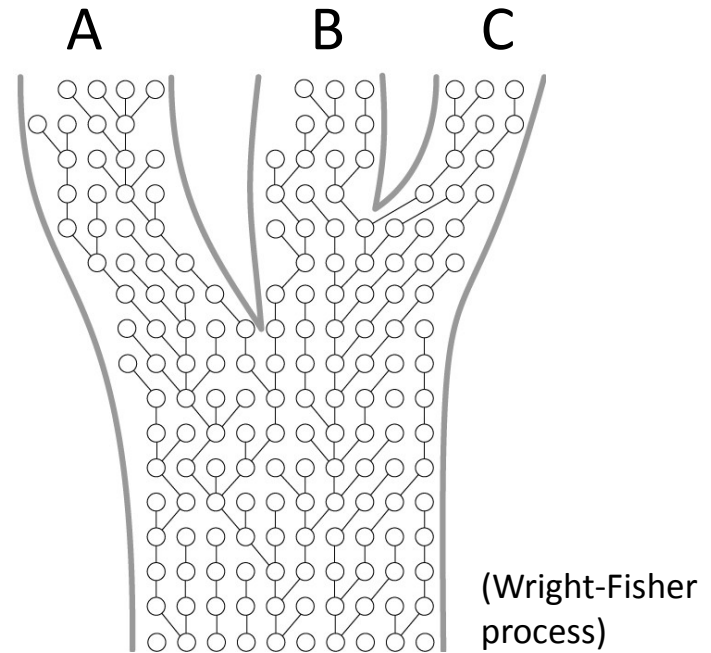

Population genetics:  
**coalescence process**

# Phylogeny at the level of populations and species

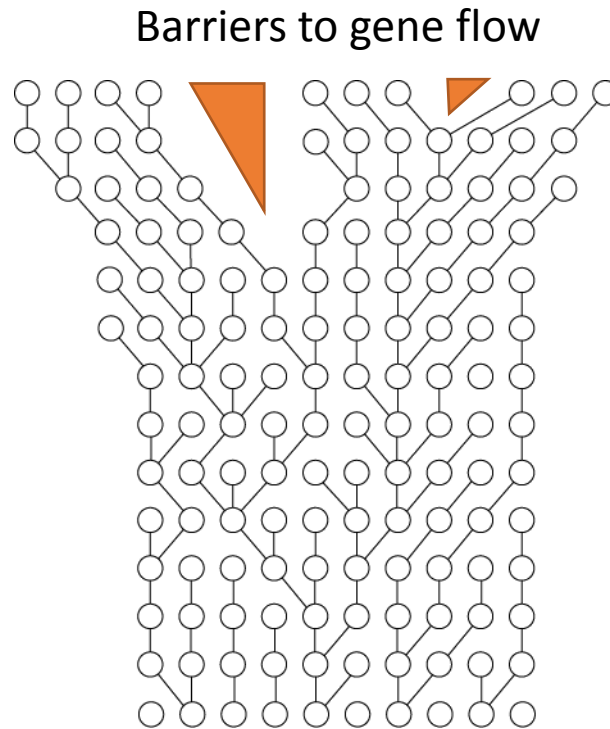

**coalescence process**

○: individual organisms / allele copy

# Phylogeny at the level of populations and species

separately evolving metapopulation lineages

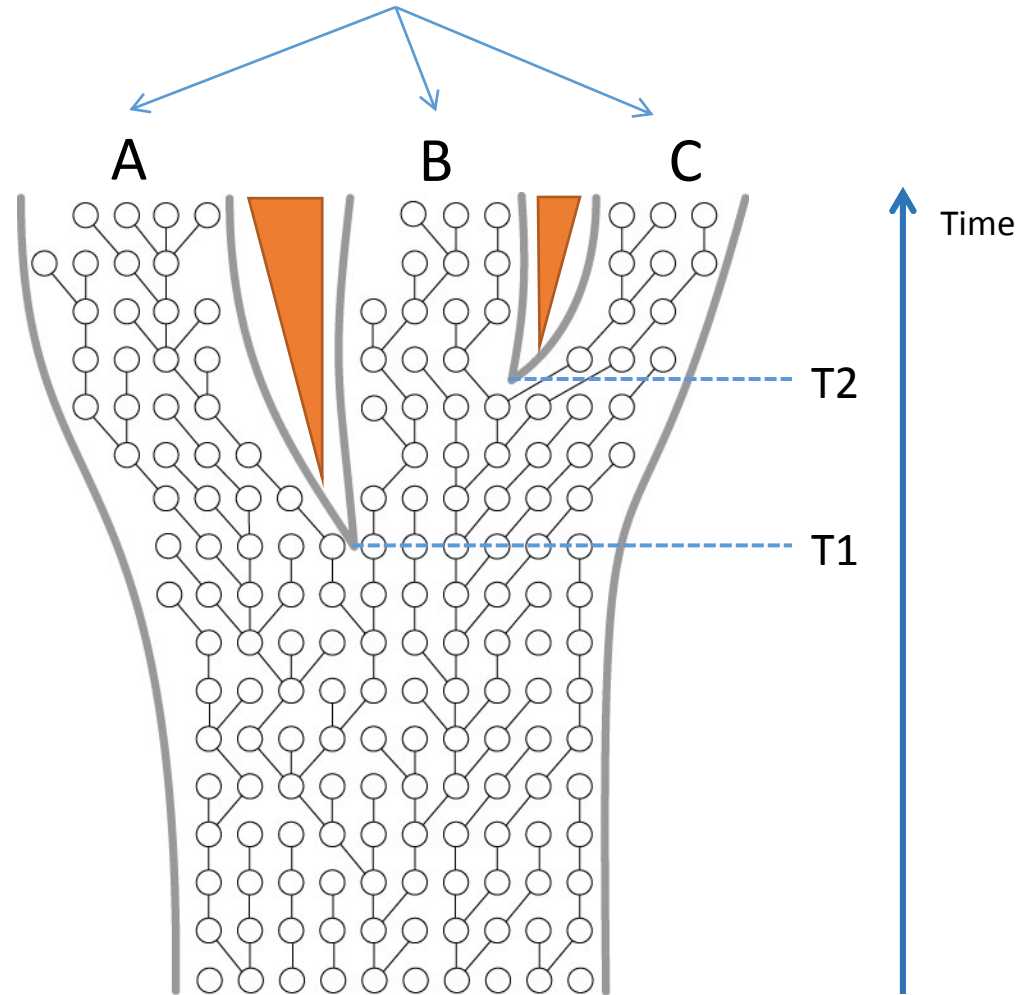

# Phylogeny at the level of populations and species

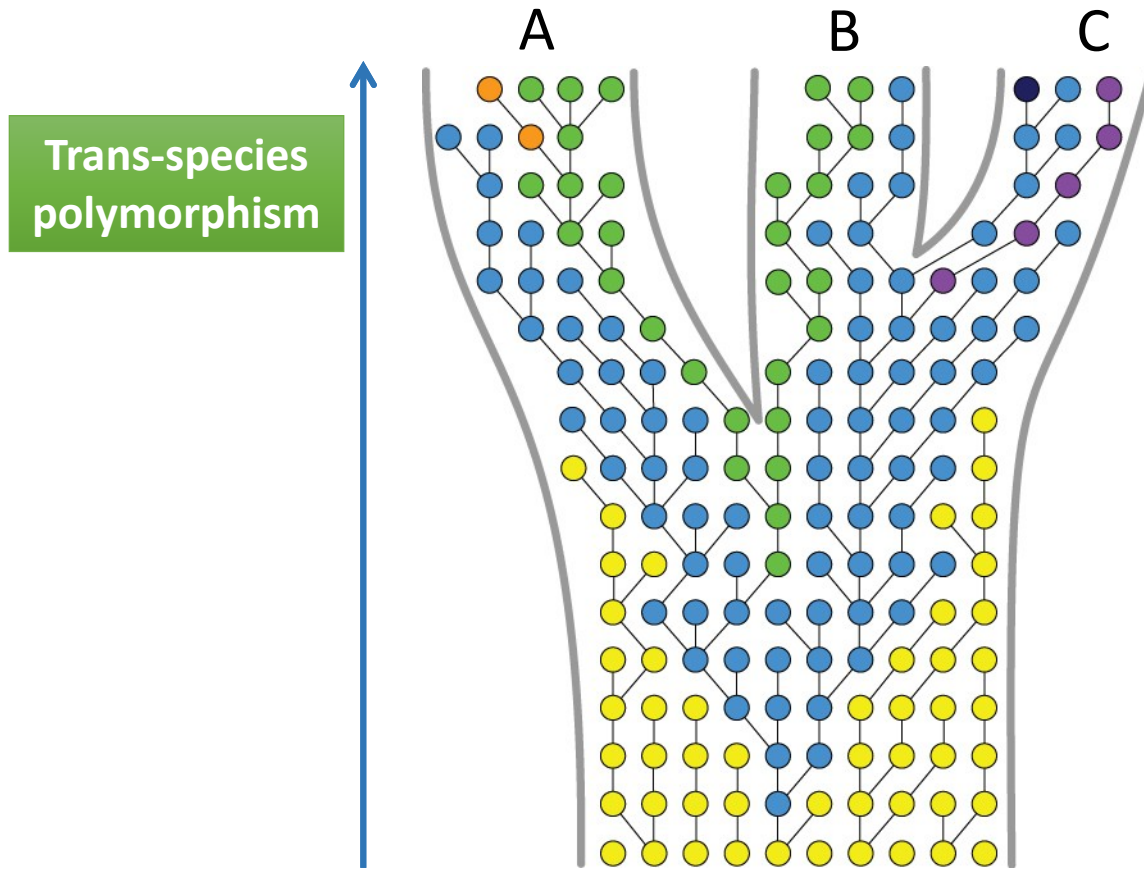



# Phylogeny at the level of populations and species

Trans-species polymorphism

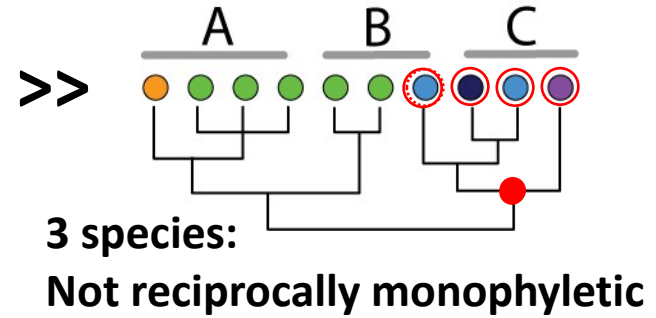
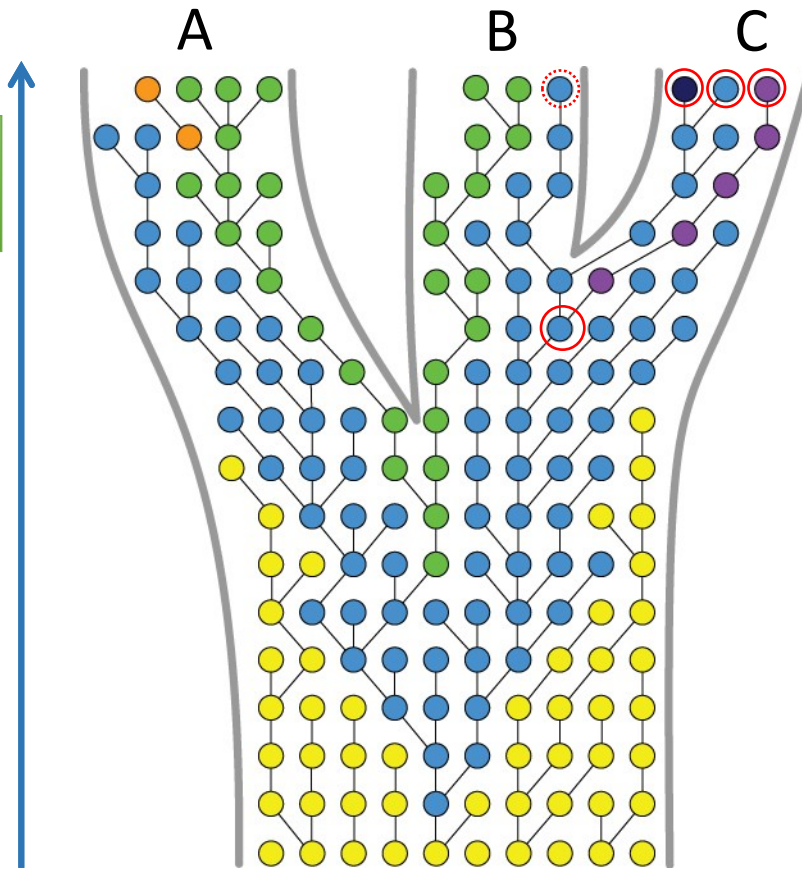

# Phylogeny at the level of populations and species

Reciprocal  
monophyly

Fixation of alleles

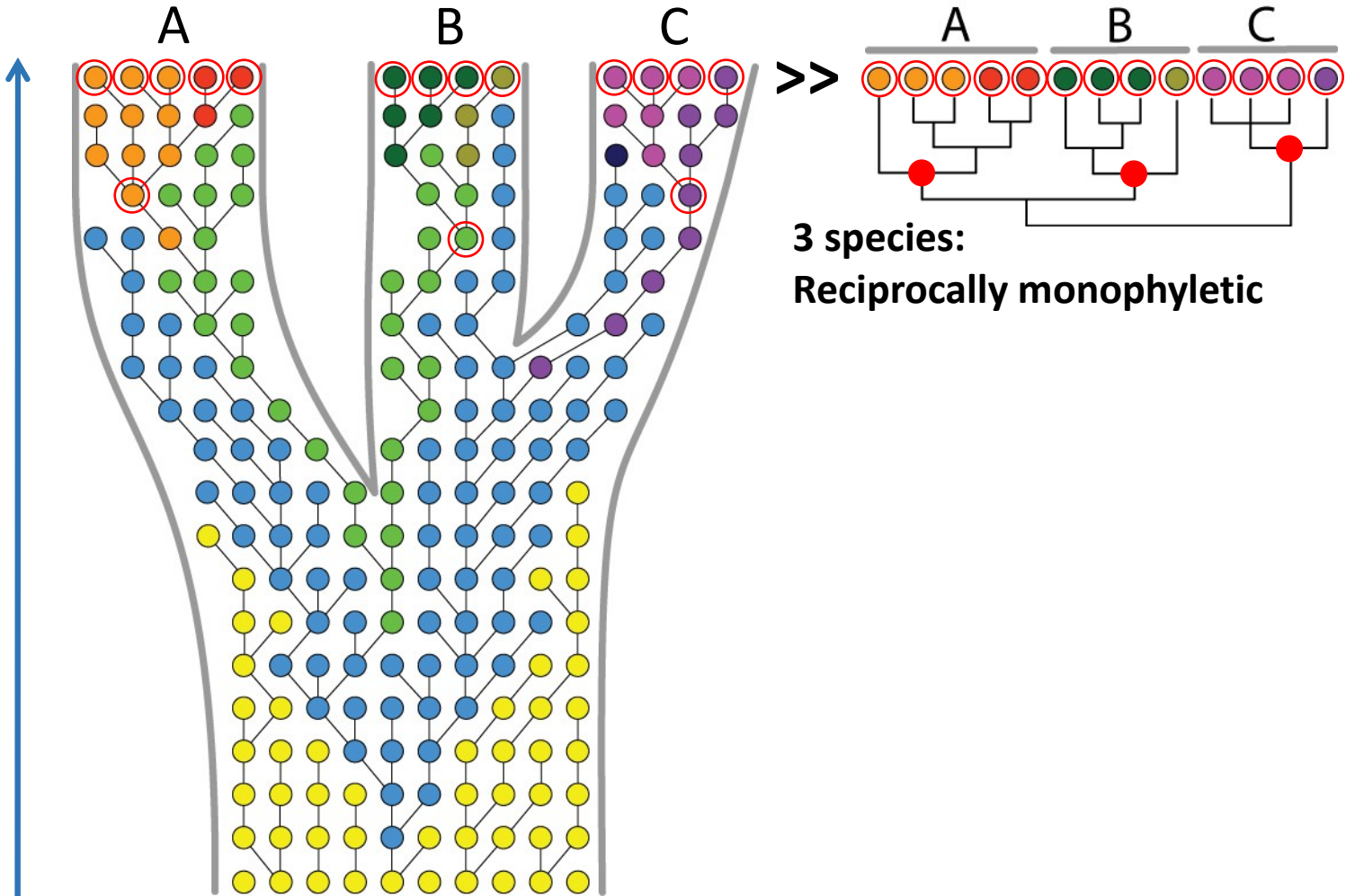

# Phylogeny at the level of populations and species

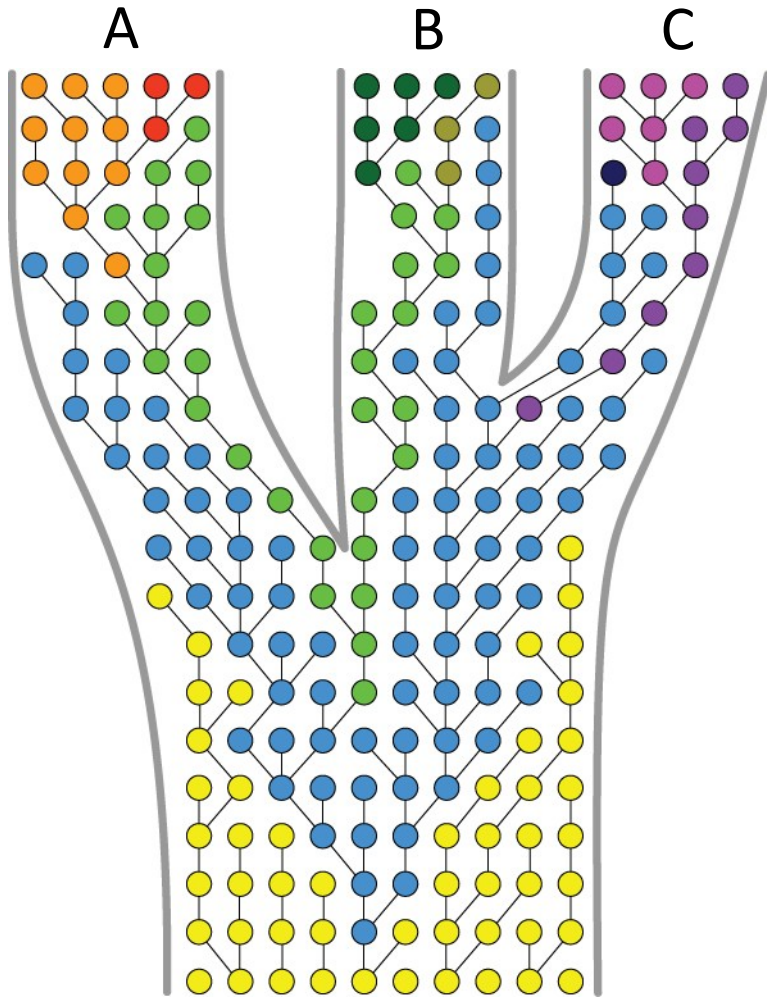

- Gene genealogies below and above the species level are different in nature

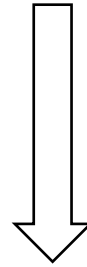

## **species delimitation**

- population genetics
- phylogenetics

# Single-locus delimitation methods

- gene tree lineages that are found in different species cannot coalesce to a common ancestor („no interspecific gene flow“)
- **general mixed Yule coalescent model (GMYC)** – model the transition point between cladogenesis and allele coalescence
- prone to over-delimitation
  
- similar approaches: **mPTP**, **ABGD** („automated barcoding gap detection“)
  
- should be combined with other approaches



*Mus (Nannomys) mattheyi*  
Senegal, Dar Salam, 2006  
Photo by J. Červený

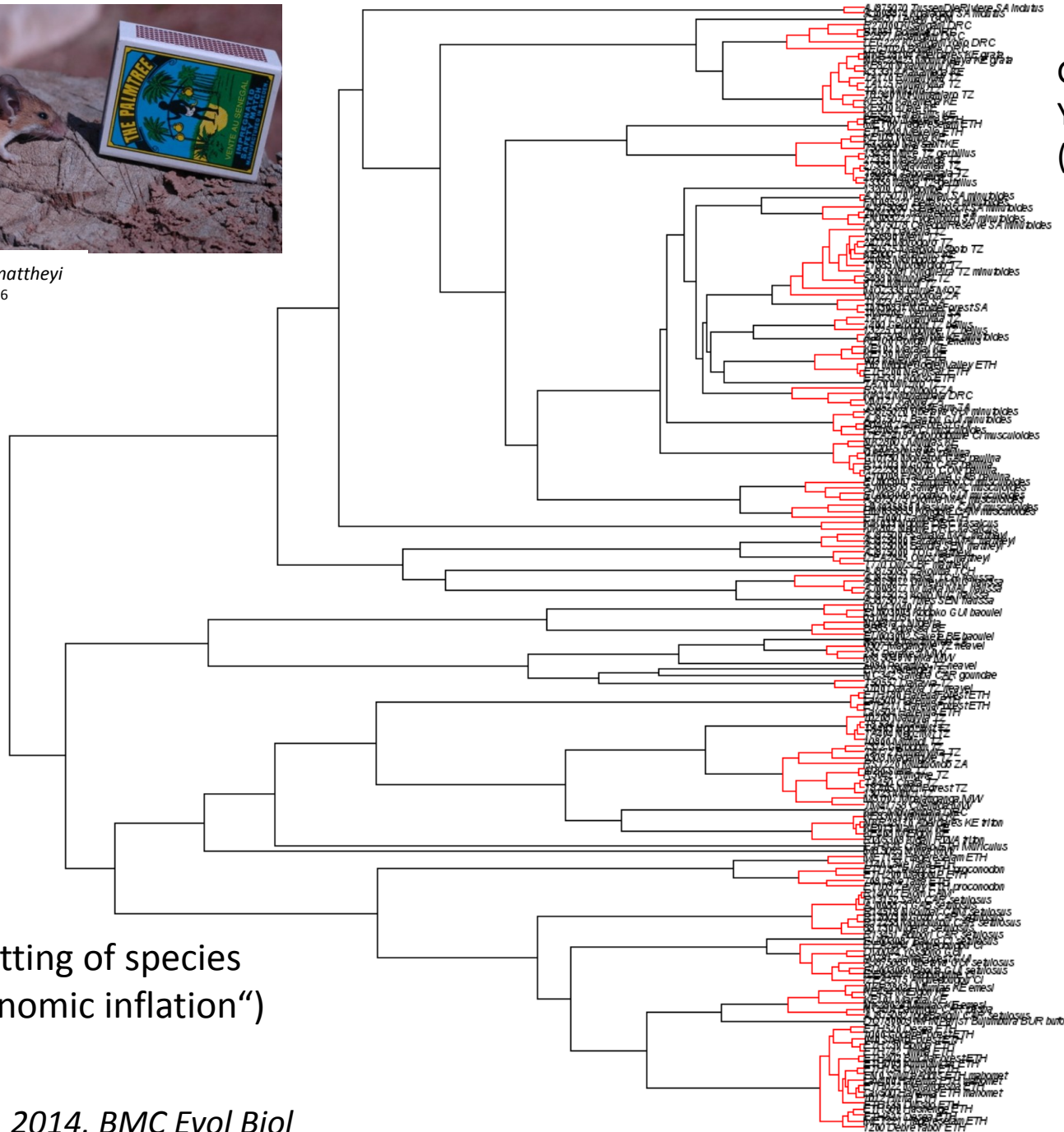

Generalized mixed  
Yule-coalescent model  
(GMYC; Pons et al. 2006)

**red** =  
intraspecific  
branching  
(coalescent process)

**black** =  
branching  
between species  
(Yule model  
including speciation  
and extinction rates)

→ splitting of species  
(„taxonomic inflation“)

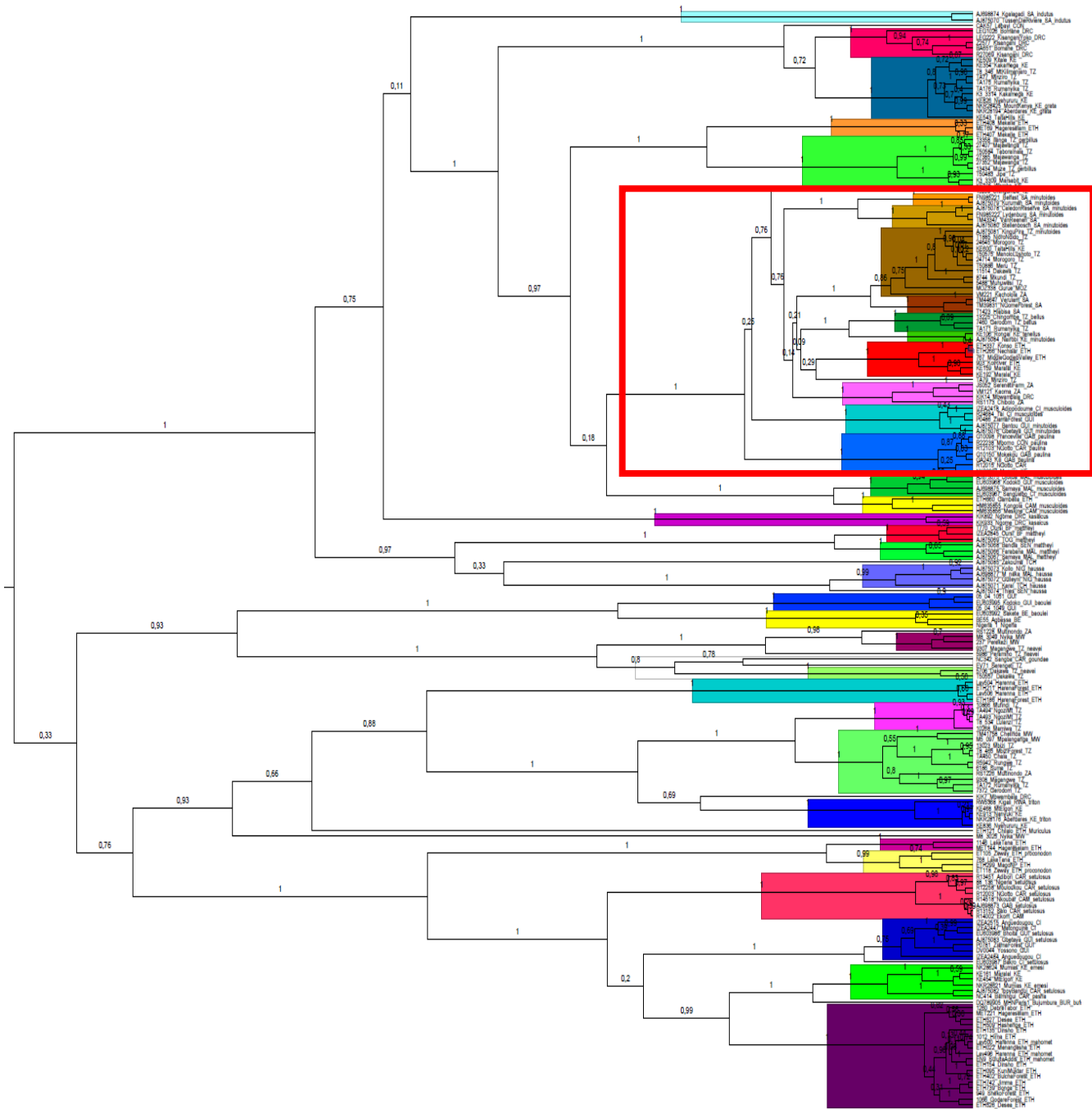

*Mus minutoides*



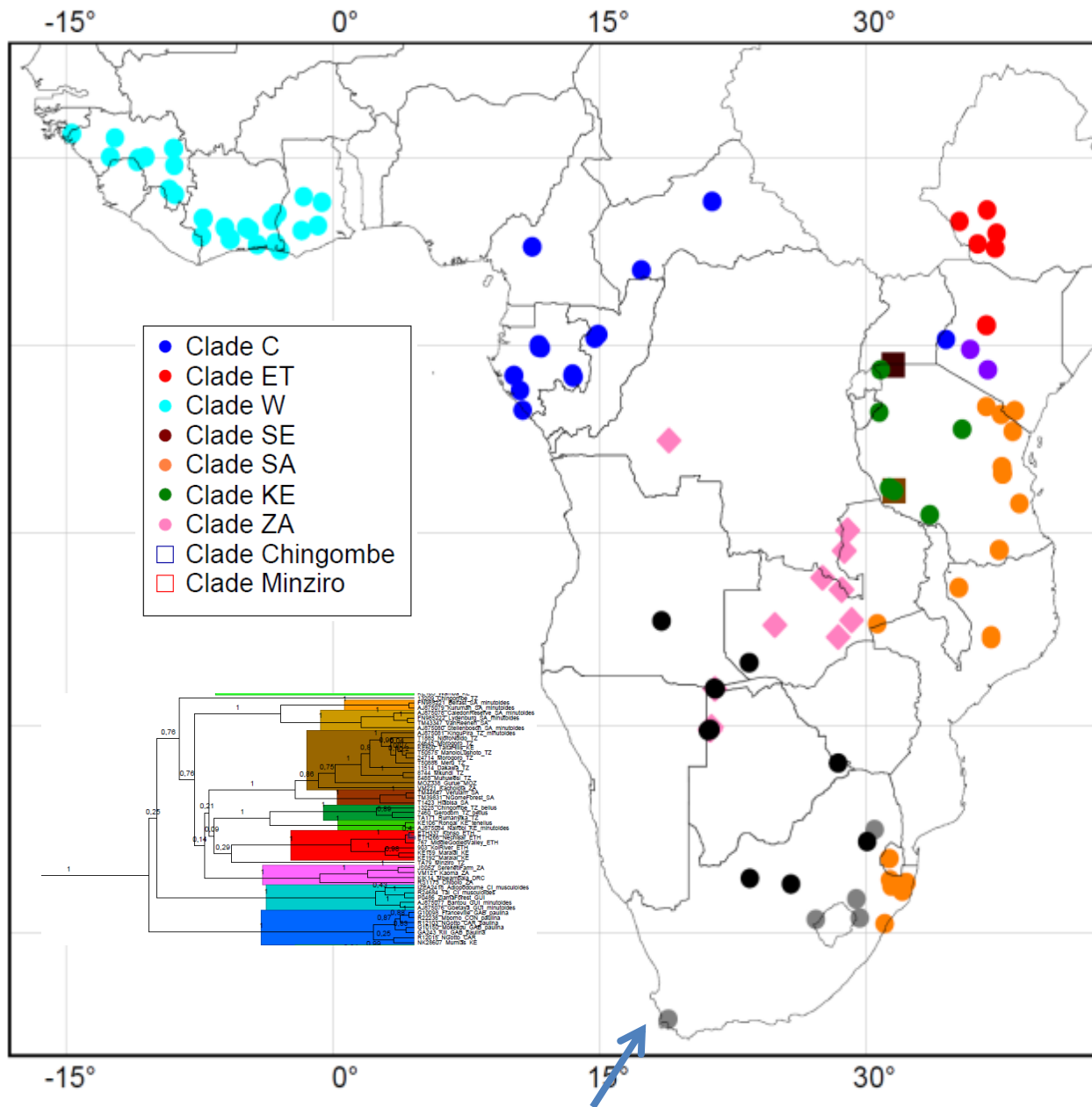

## *Mus minutoides*

- monophyletic clade *M. minutoides*
- **12 „species“** identified by GMYC approach (**3.27-6.96% K2P-distance** among lineages)
- mostly parapatric distribution
- spatial genetic structure is similar to other widely distributed savanna species = **intraspecific phylogeographic structure**

# → Correction of number of possible taxa

- „GMYC identified species“ collapsed to **MOTUs** (= putative species) if:

(1) parapatric distribution of sister lineages

AND

(2) genetic distances among sister lineages lower than 7% (treshold based on *M. minutoides*)

# MOTUs vs. genetic distances

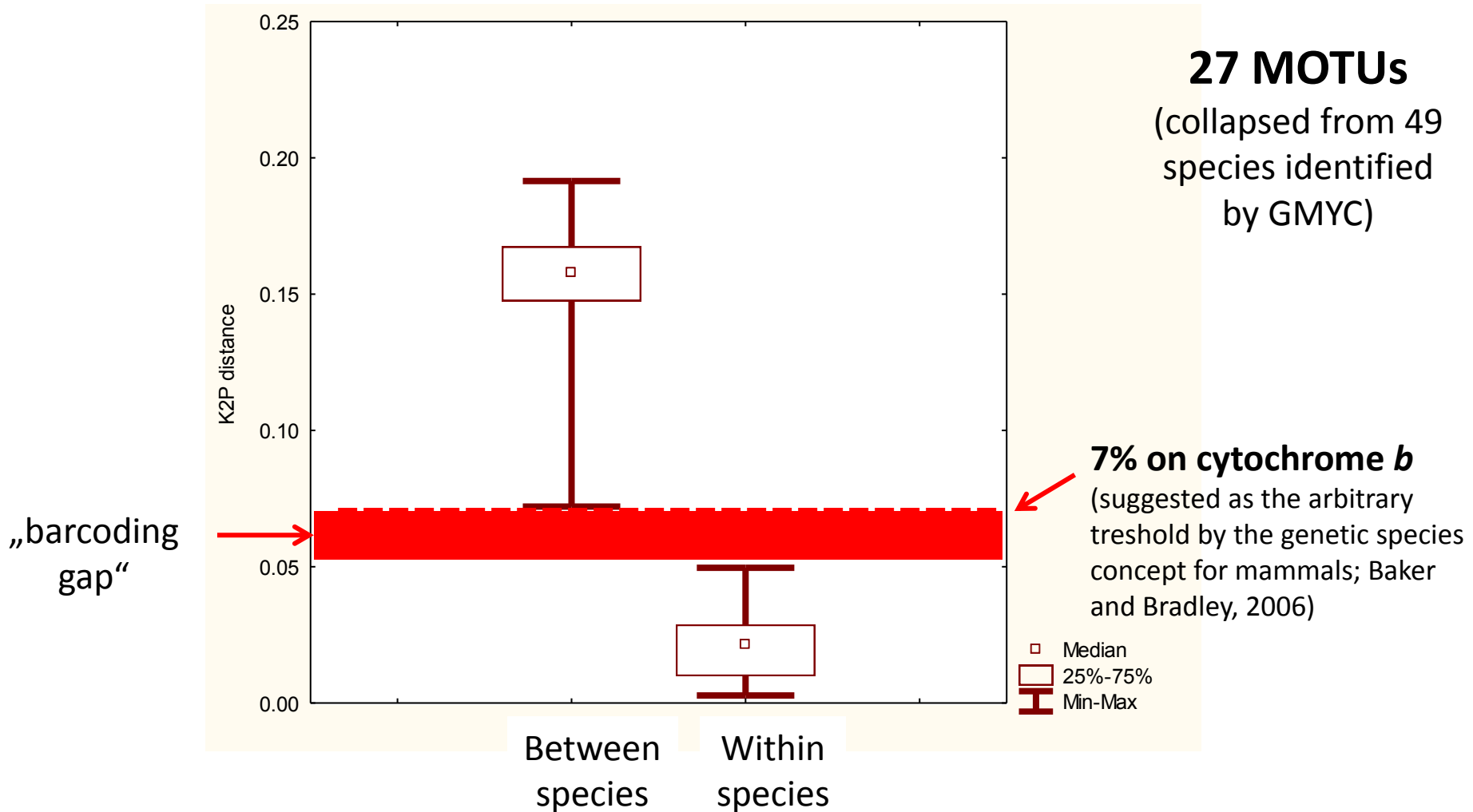

# 27 MOTUs after correction of GMYC delimitations

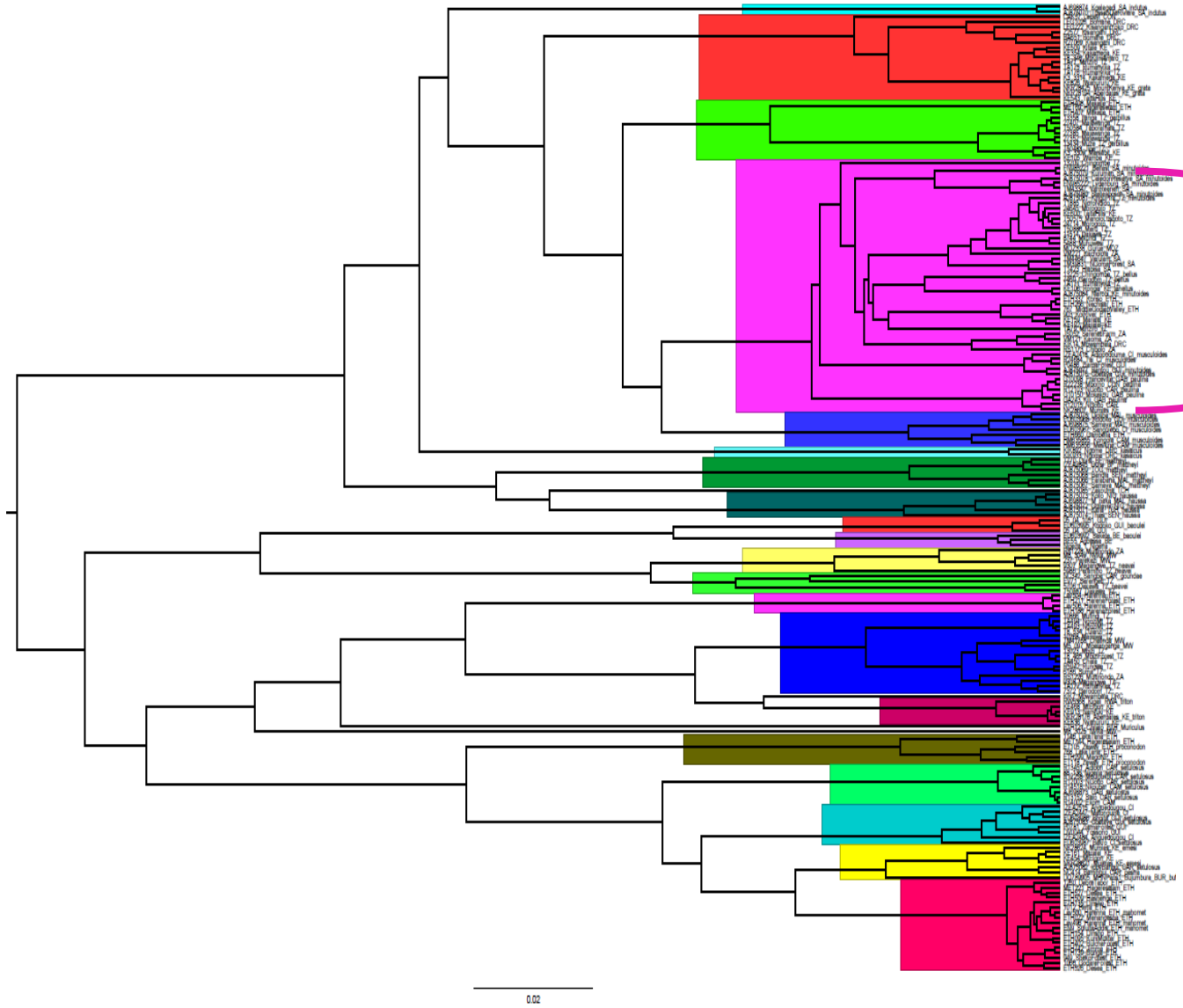

- 27 MOTUs (7.2-19.2% distance)

*Mus minutoides*

# How many species of *Nannomys*?

Bryja et al. *BMC Evolutionary Biology* (2014) 14:256  
DOI 10.1186/s12862-014-0256-2



RESEARCH ARTICLE

Open Access

## Pan-African phylogeny of *Mus* (subgenus *Nannomys*) reveals one of the most successful mammal radiations in Africa

Josef Bryja<sup>1,2,13\*</sup>, Ondřej Mikula<sup>1,3</sup>, Radim Šumbera<sup>4</sup>, Yonas Meheretu<sup>5</sup>, Tatiana Aghová<sup>1,2</sup>, Leonid A Lavrenchenko<sup>6</sup>, Vladimír Mazoch<sup>4</sup>, Nicholas Oguge<sup>7</sup>, Judith S Mbau<sup>8</sup>, Kiros Welegerima<sup>5</sup>, Nicaise Amundala<sup>9</sup>, Marc Colyn<sup>10</sup>, Herwig Leirs<sup>11</sup> and Erik Verheyen<sup>11,12</sup>

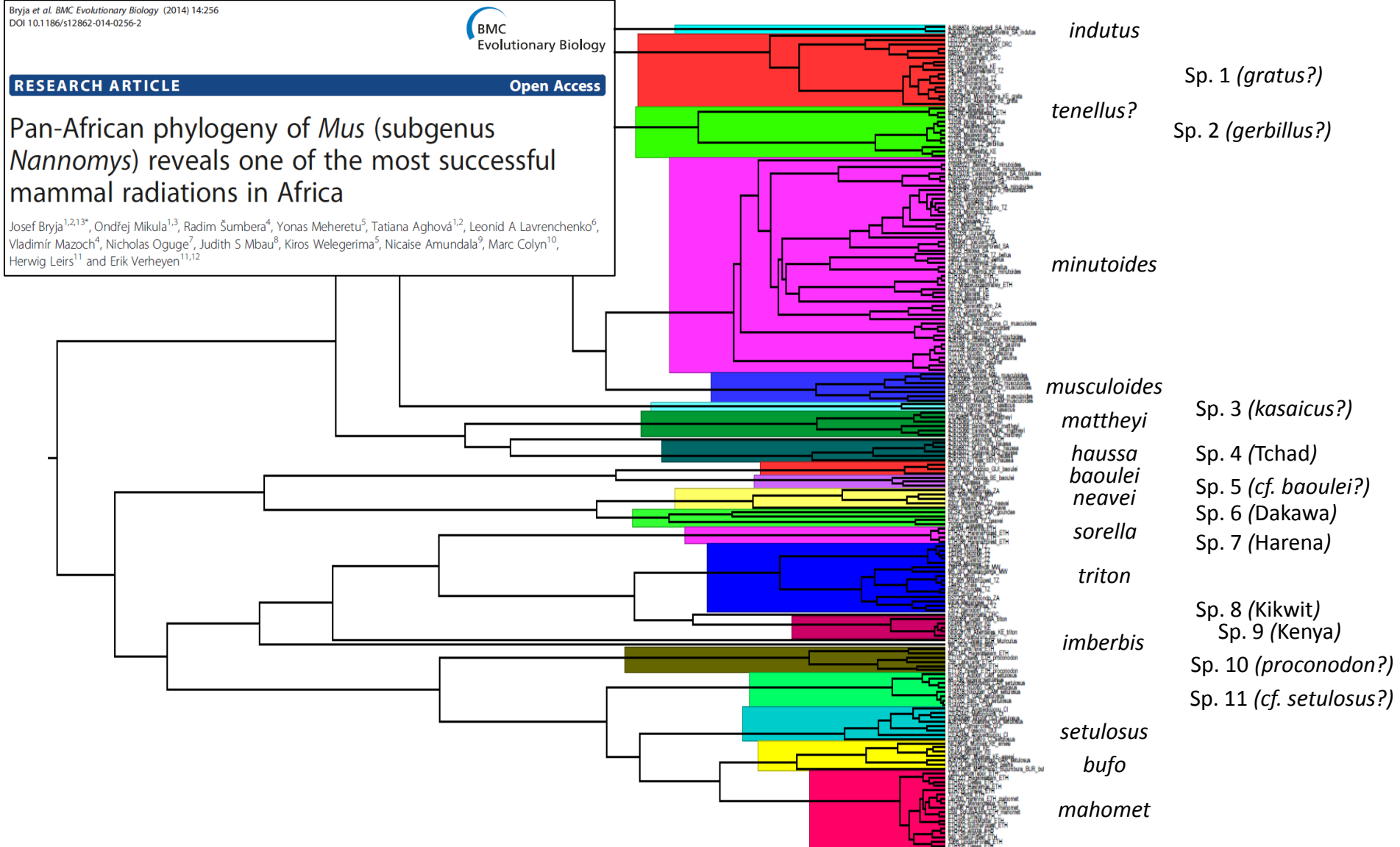

*indutus*

Sp. 1 (*gratus?*)

*tenellus?*

Sp. 2 (*gerbillus?*)

*minutoides*

*musculoides*

Sp. 3 (*kasaicus?*)

*mattheyi*

Sp. 4 (Tchad)

*haussa*

*baulei*

Sp. 5 (*cf. baulei?*)

*neavei*

Sp. 6 (Dakawa)

*sorella*

Sp. 7 (Harena)

*triton*

Sp. 8 (Kikwit)

Sp. 9 (Kenya)

*imberbis*

Sp. 10 (*proconodon?*)

Sp. 11 (*cf. setulosus?*)

*setulosus*

*bufo*

*mahomet*

0.02

VALID NAMES  
(14-15)

NEW SPECIES  
(11-12)

# Multi-species coalescence for species delimitation

- **multi-locus data**
- **BPP** (joint estimates of species delimitation and species tree)
- spedeSTEM
- STACEY
- and others



# Multilocus data, multi-species coalescence

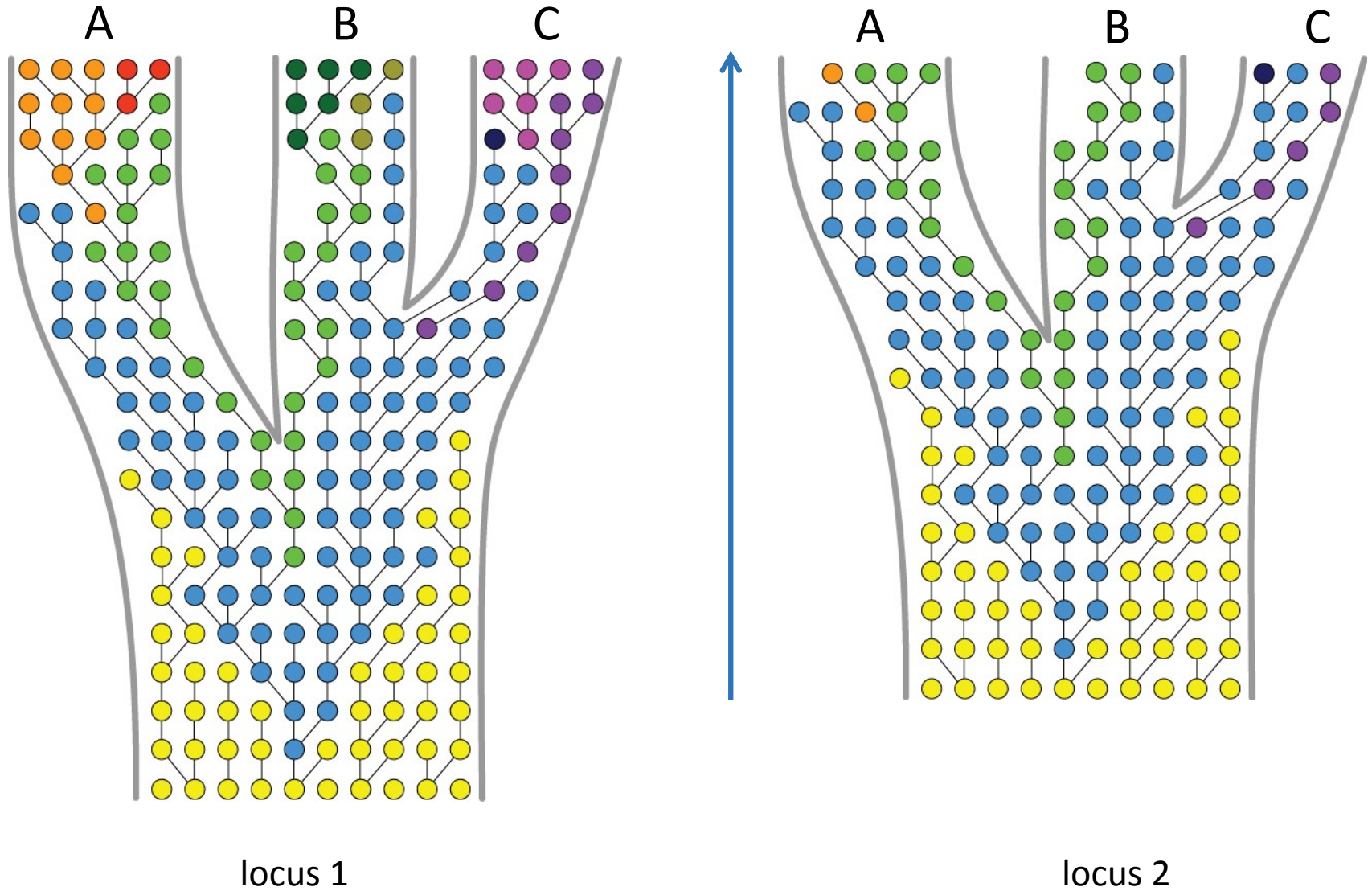



# Example: 6 nuclear loci in *Stenocephalemys*

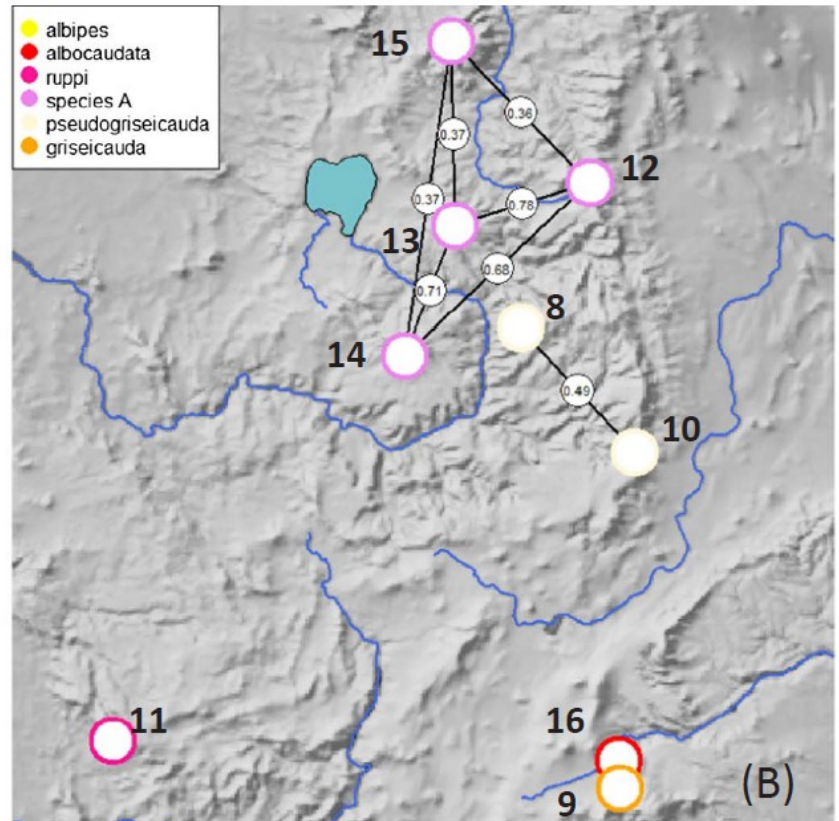
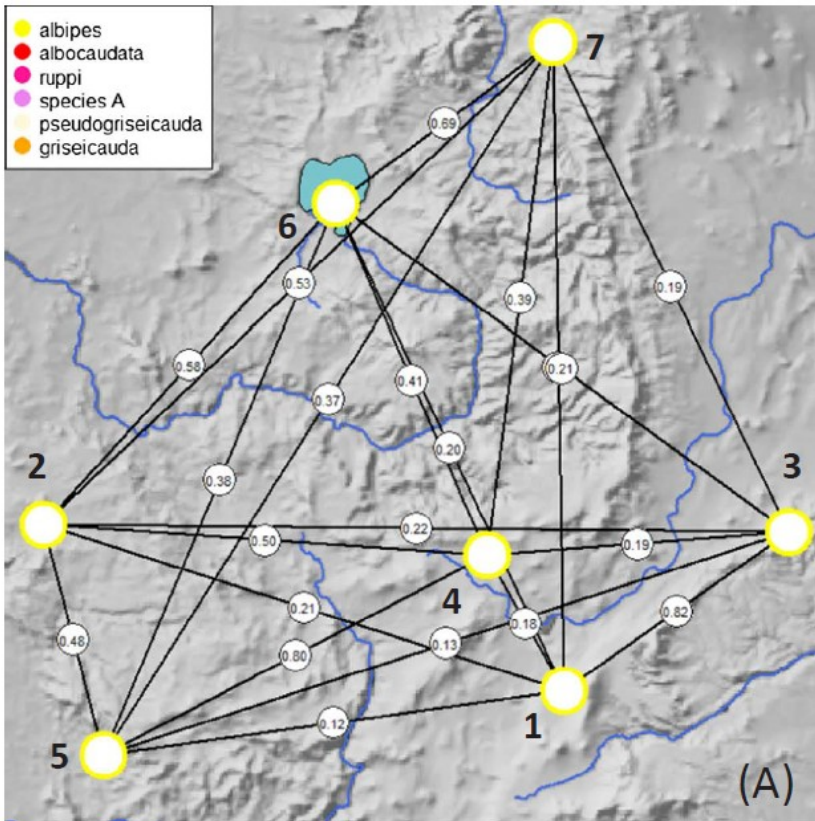

STACEY - species delimitation

# Example: 6 nuclear loci in *Stenocephalemys*

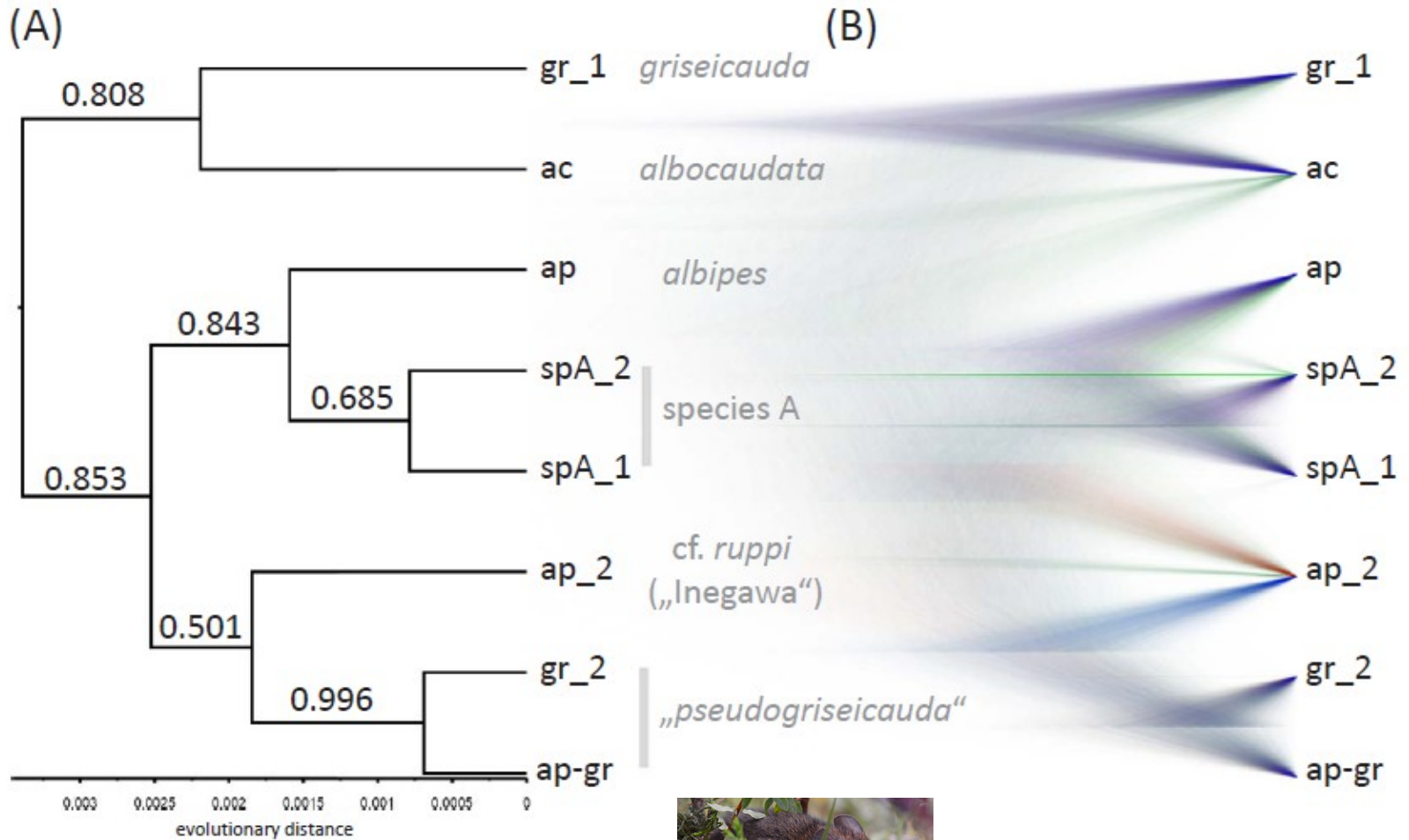

StarBEAST – species tree



Bryja et al. 2018, *Mol Phyl Evol*



# Integrative taxonomy of *Stenocephalemys*

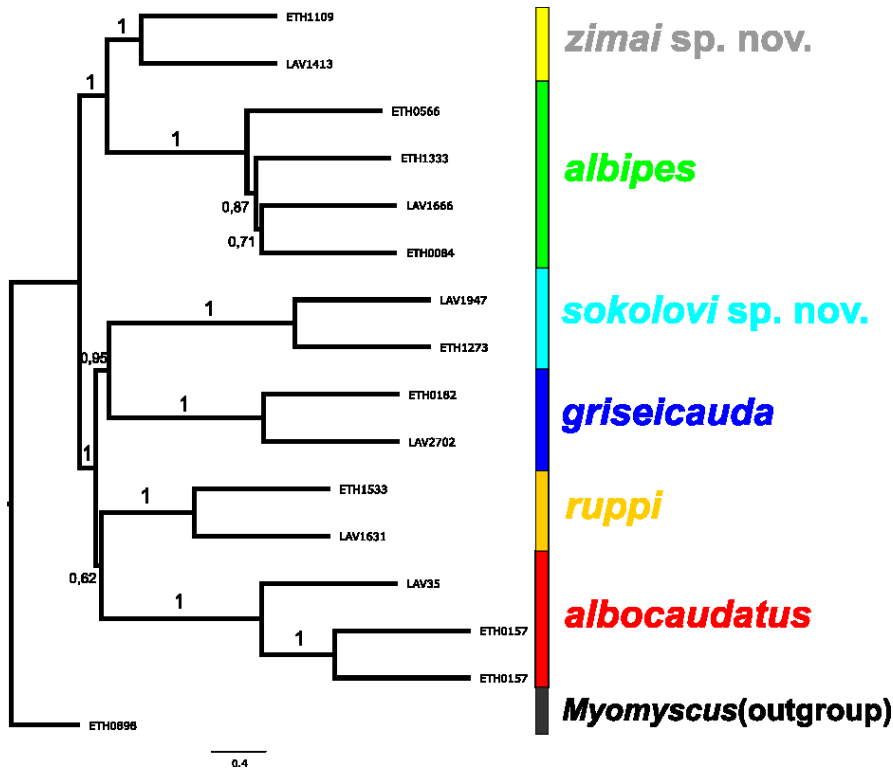

anchored phylogenomics  
(388 nuclear loci)

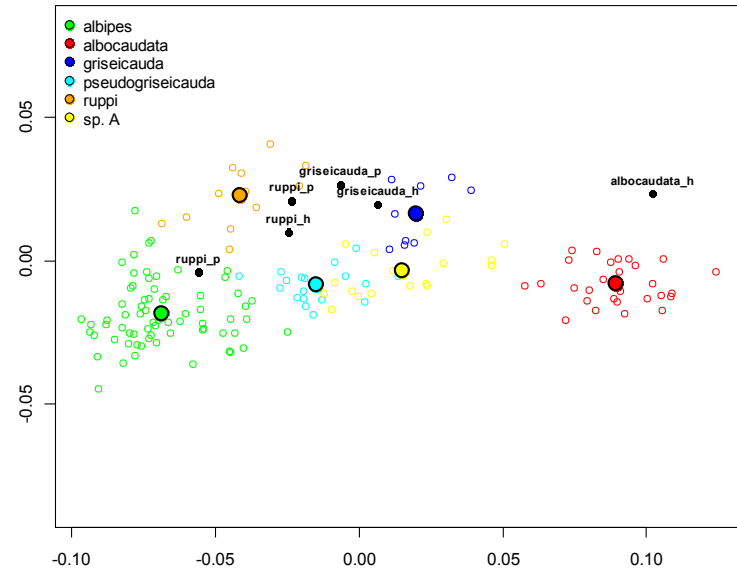

# Incongruent results from empirical systems



*Aliatypus* spiders

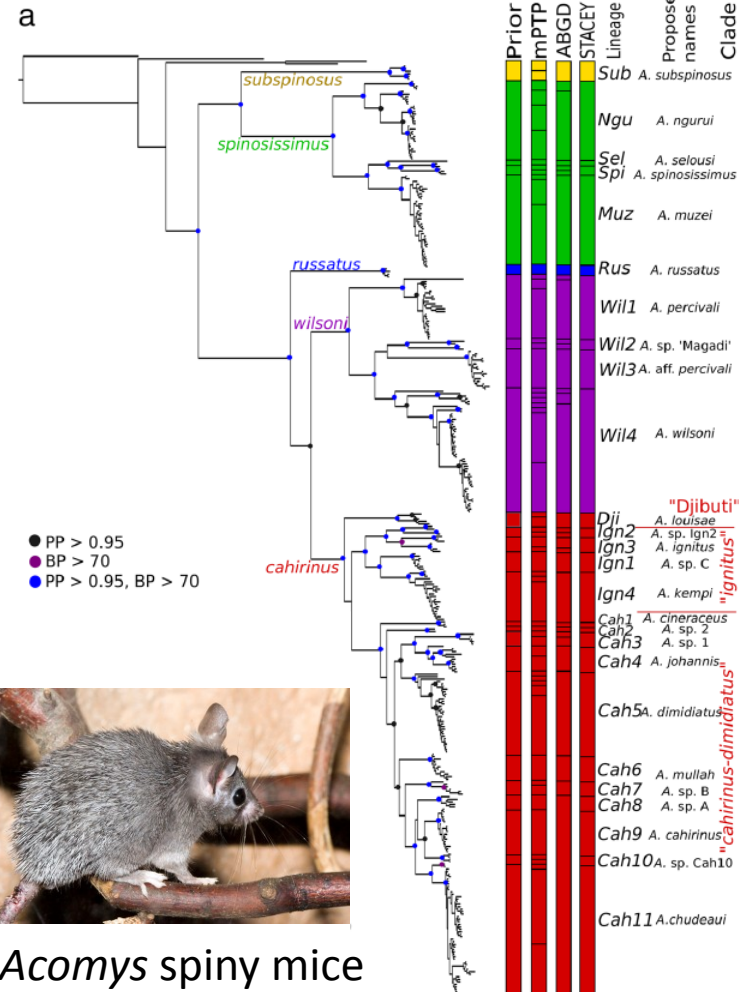
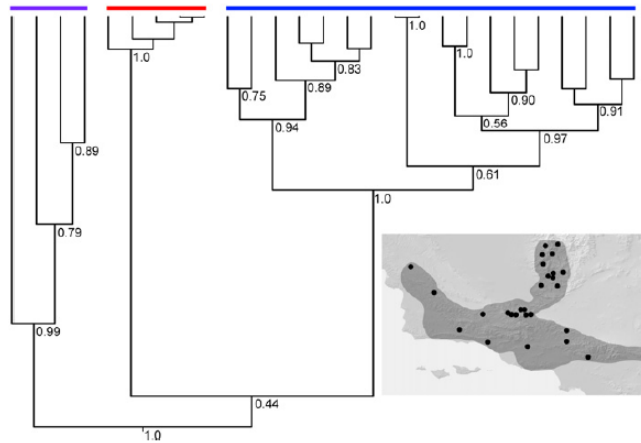

*Acomys* spiny mice

# MSC identifies population structure, not species

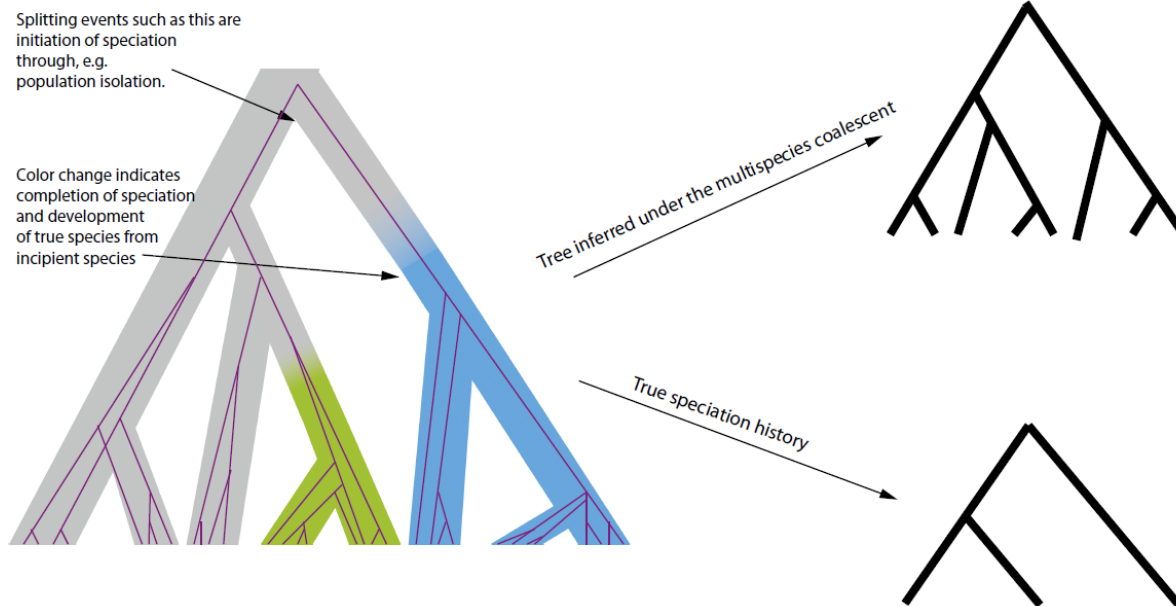

- „until we develop genomic-based species delimitation approaches that are able to discriminate between population- and species-level structuring, it is important not just to recognize, but to treat and report **the units delimited under MSC at best as tentative hypotheses of species**“



# Is it possible to define a species?

It is really laughable to see what different ideas are prominent in various naturalists minds, when they speak of „species“; ... It all comes, I believe, from trying to define the indefinable.

*Darwin 1856*

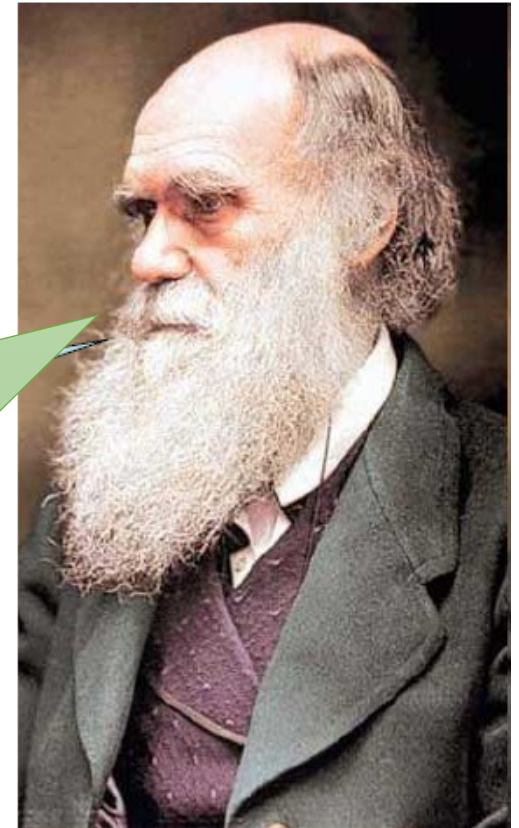

# THE RISE OF GENOMICS – CAN IT HELP?

# High-throughput sequencing (HTS)

- unprecedented increase of genetic data
- „several-loci“ approaches for species delimitation applicable with difficulties – computationally demanding → **new approaches for HTS data are highly required** (and are intensively developed)

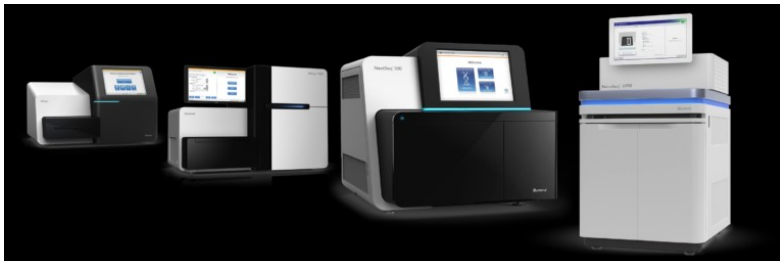
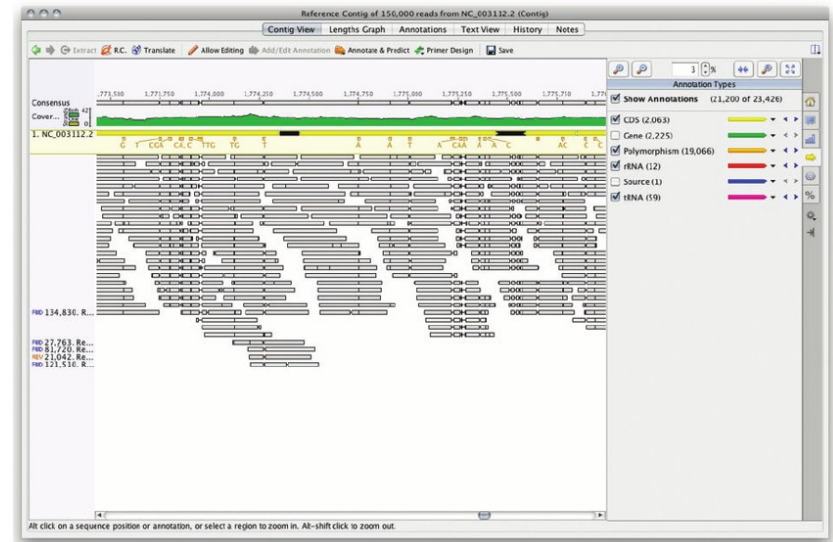

# Alternative approaches for species delimitation from genomic data



- ancestral lineage in Ethiopian highlands, where diversified and sourced the colonization of other mountains (**mostly in Pleistocene**)
- *Lophuromys flavopunctatus* complex





# Nine endemic species in Ethiopia

BULLETIN DE L'INSTITUT ROYAL DES SCIENCES NATURELLES DE BELGIQUE  
 BULLETIN VAN HET KONINKLIJK BELGISCH INSTITUUT VOOR NATUURWETENSCHAPPEN

BIOLOGIE, 77: 77-117, 2007  
 BIOLOGIE, 77: 77-117, 2007

Morphometric and genetic study of Ethiopian *Lophuromys flavopunctatus* THOMAS, 1888 species complex with description of three new 70-chromosomal species (Muridae, Rodentia)

by Leonid A. LAVRENTCHENKO, Walter N. VERHEYEN, Erik VERHEYEN, Jan HULSELMANS & Herwig LEIRS

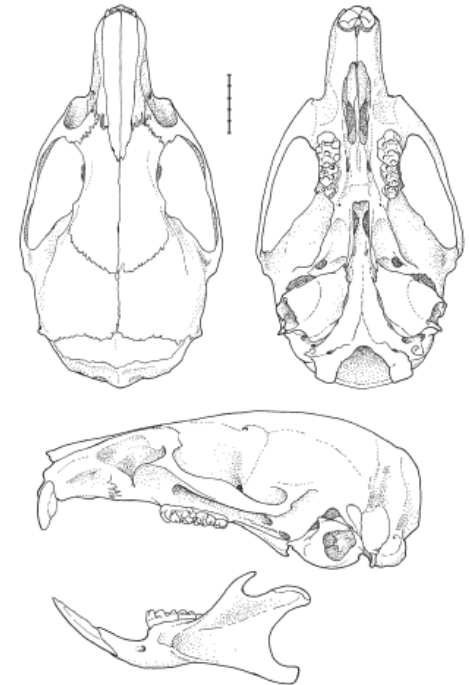
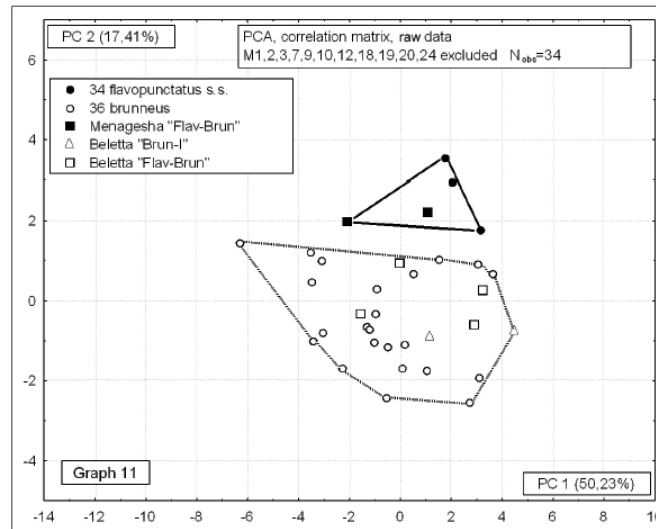
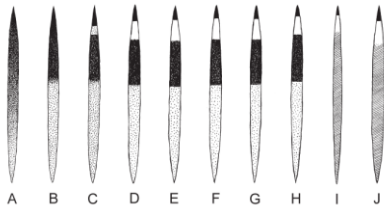

3.2. Views of skull and mandible of *Lophuromys menageshae* n.sp. (ZMMU S-165969, holotype). Scale bar = 5 mm.

# *Lophuromys flavopunctatus* group in Ethiopia

- Are there really nine well-delimited species?
- What is their distribution, co-occurrence patterns, ecological requirements? -> IUCN assessment, etc.



- 
- cca 500 specimens from all major mountain ranges barcoded at mtDNA
  - 4 nuclear markers (two introns + two exons)
  - **genomic approach (ddRAD sequencing) → thousands of SNPs across the genome**

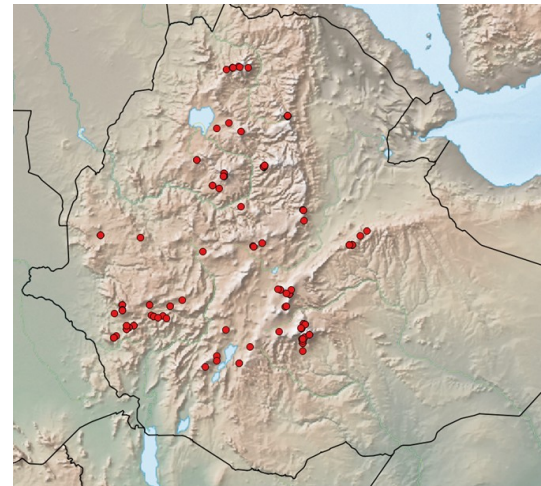



# ddRADseq: co-ancestry matrix

209  
individuals

15 623  
informative  
loci

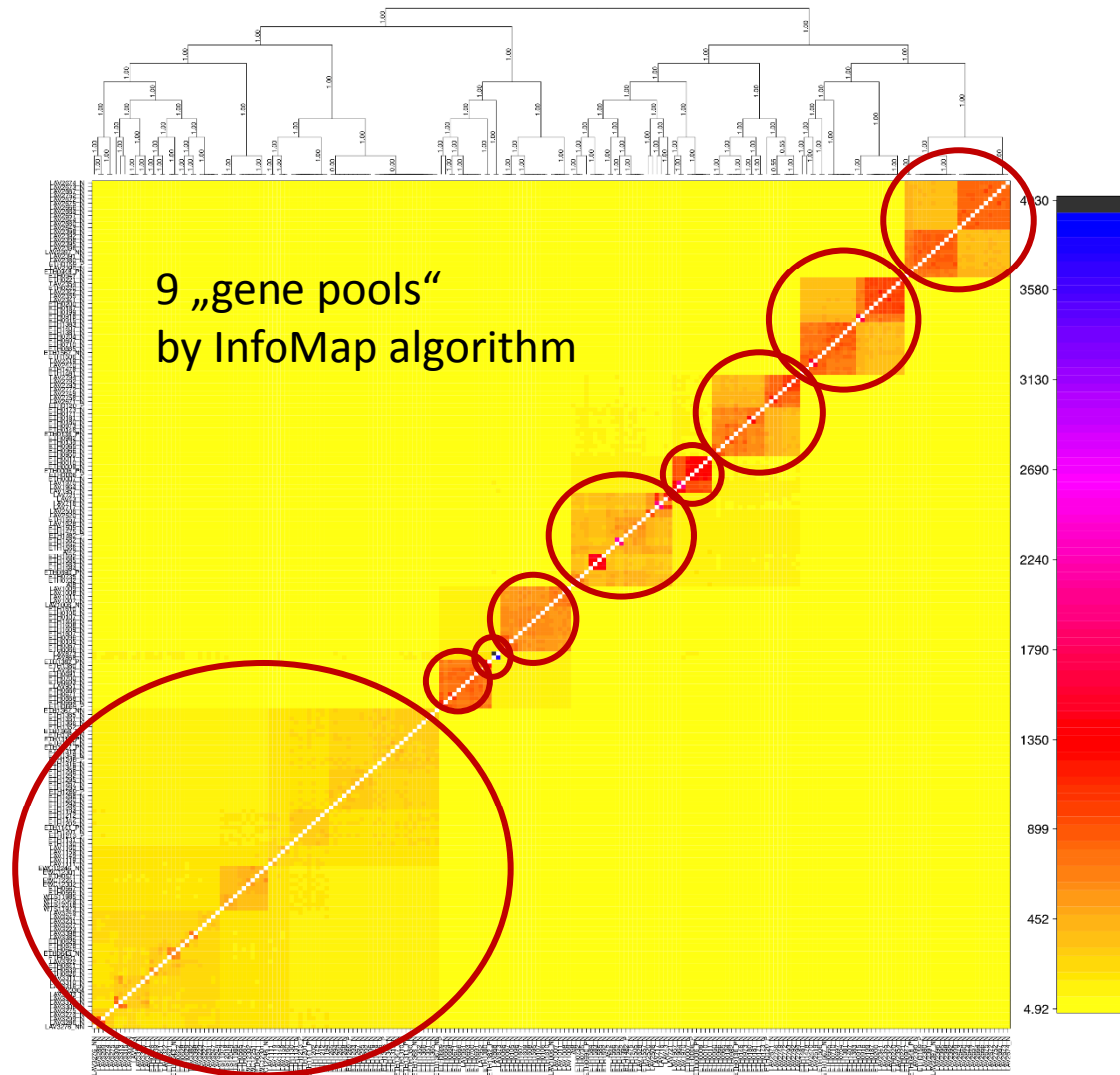

# Maximum likelihood analysis of concatenated nuclear dataset

## Sanger sequencing

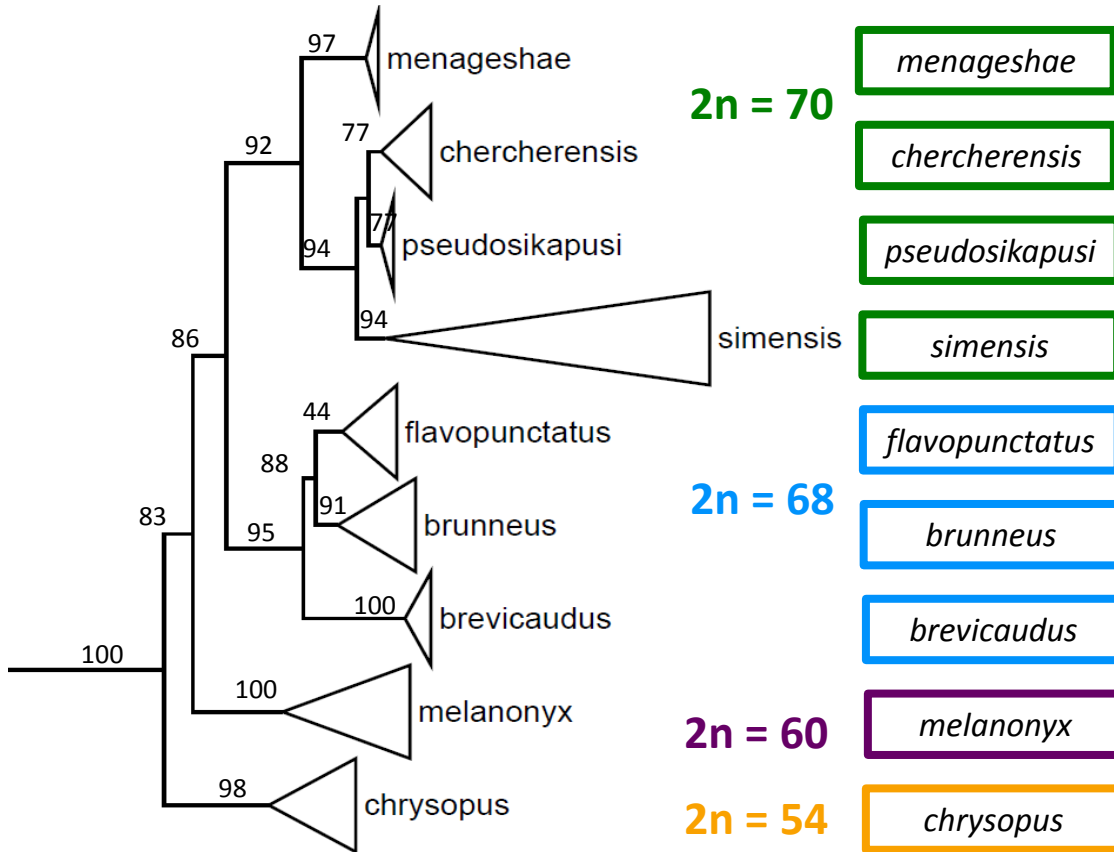

4 nuclear markers

(2 604 bp concatenated dataset)

## ddRADseq

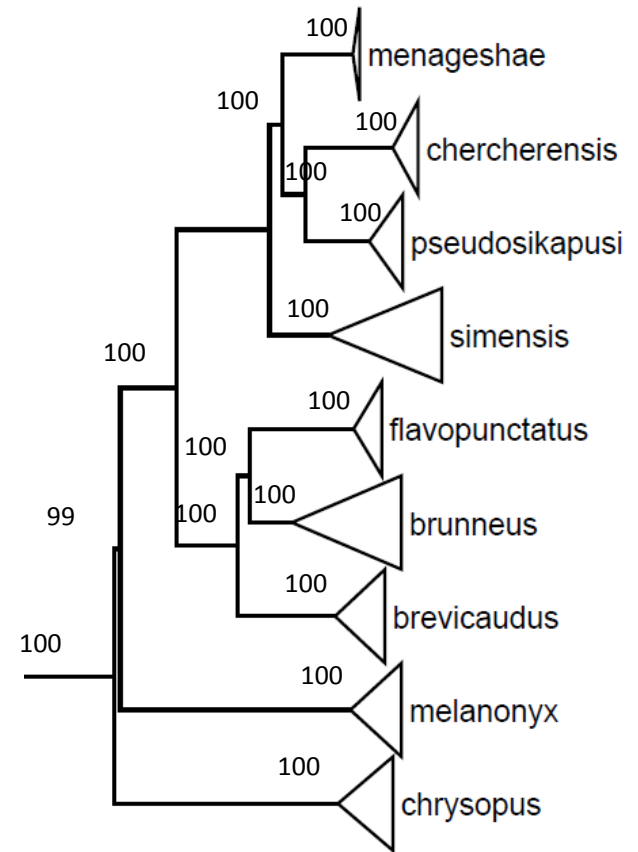



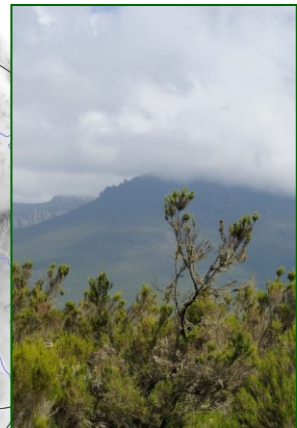
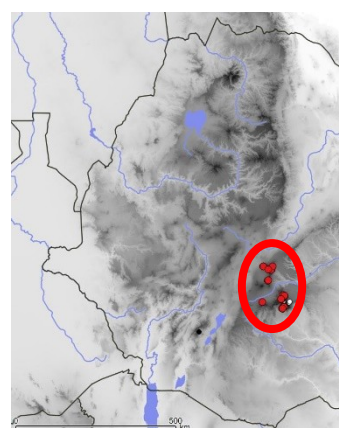
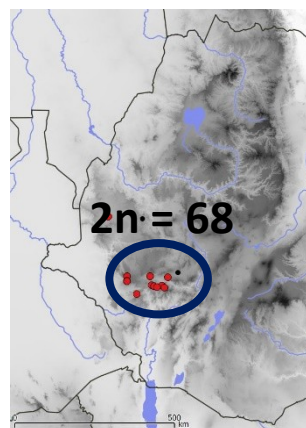
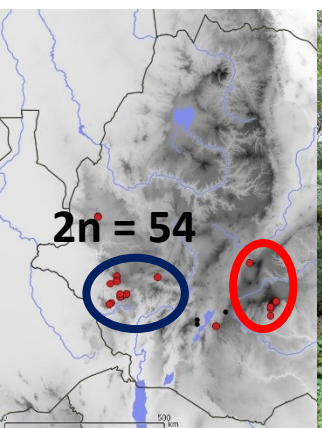
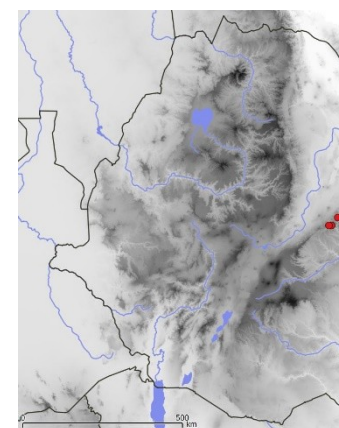
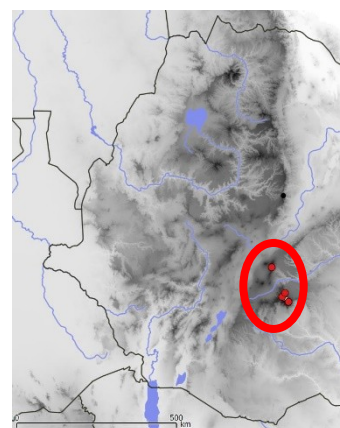
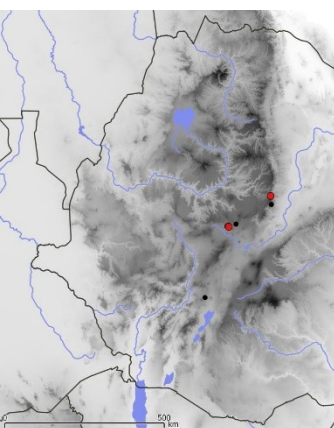
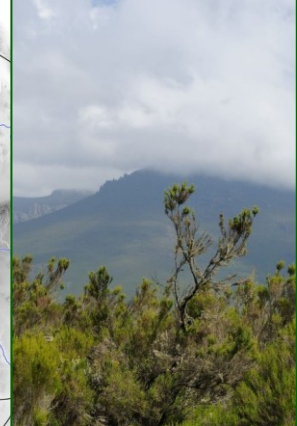
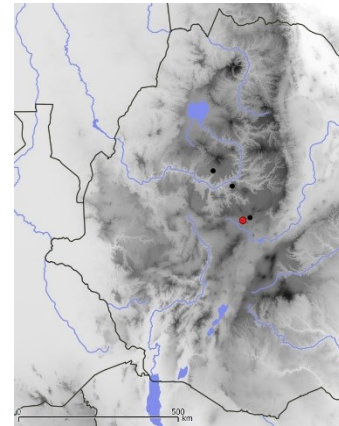
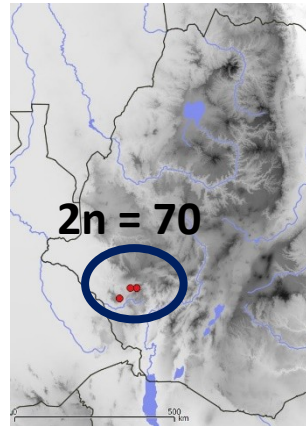
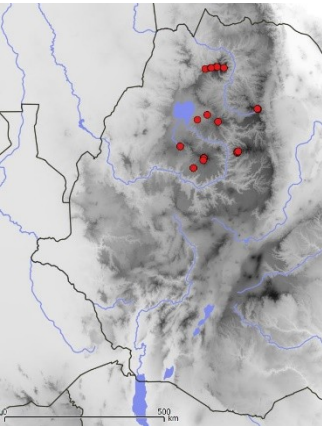

**5. MITOCHONDRIAL INTROGRESSION**  
AND A UNIFYING SPECIES CONCEPT  
(?)

# Dobzhansky-Muller incompatibility

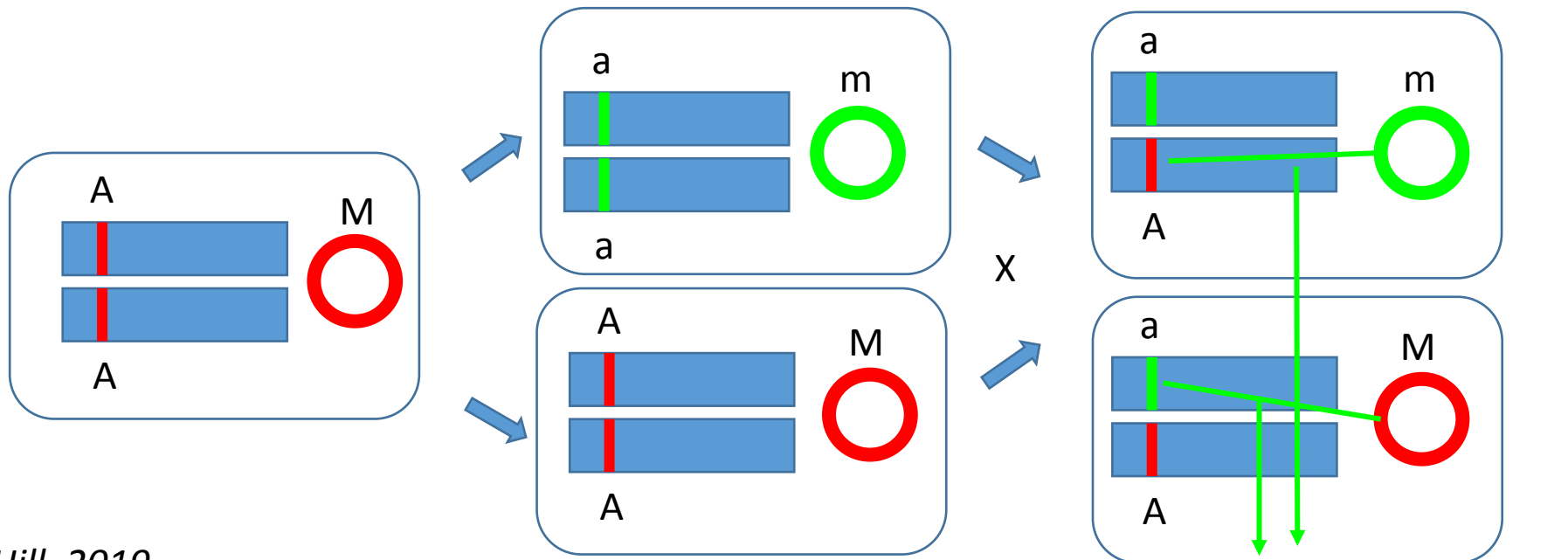
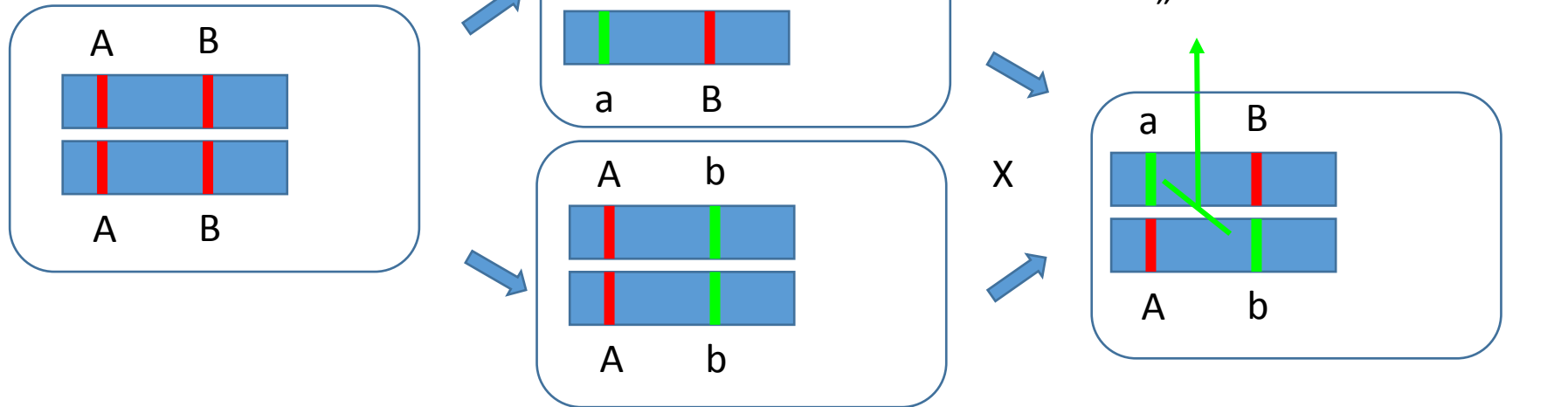



# Oxidative phosphorylation (OXPHOS) by electron transport system (ETS)

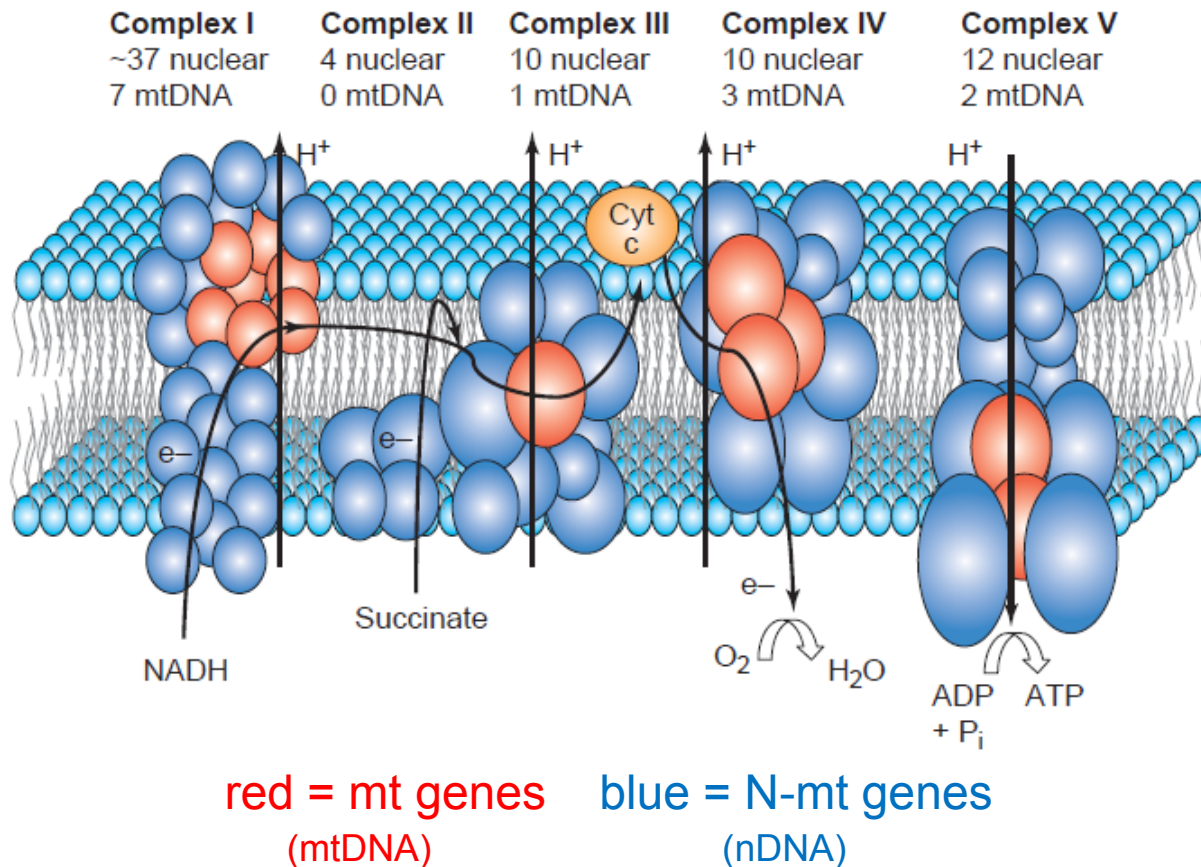



# Co-adaptation of mt and N-mt genes

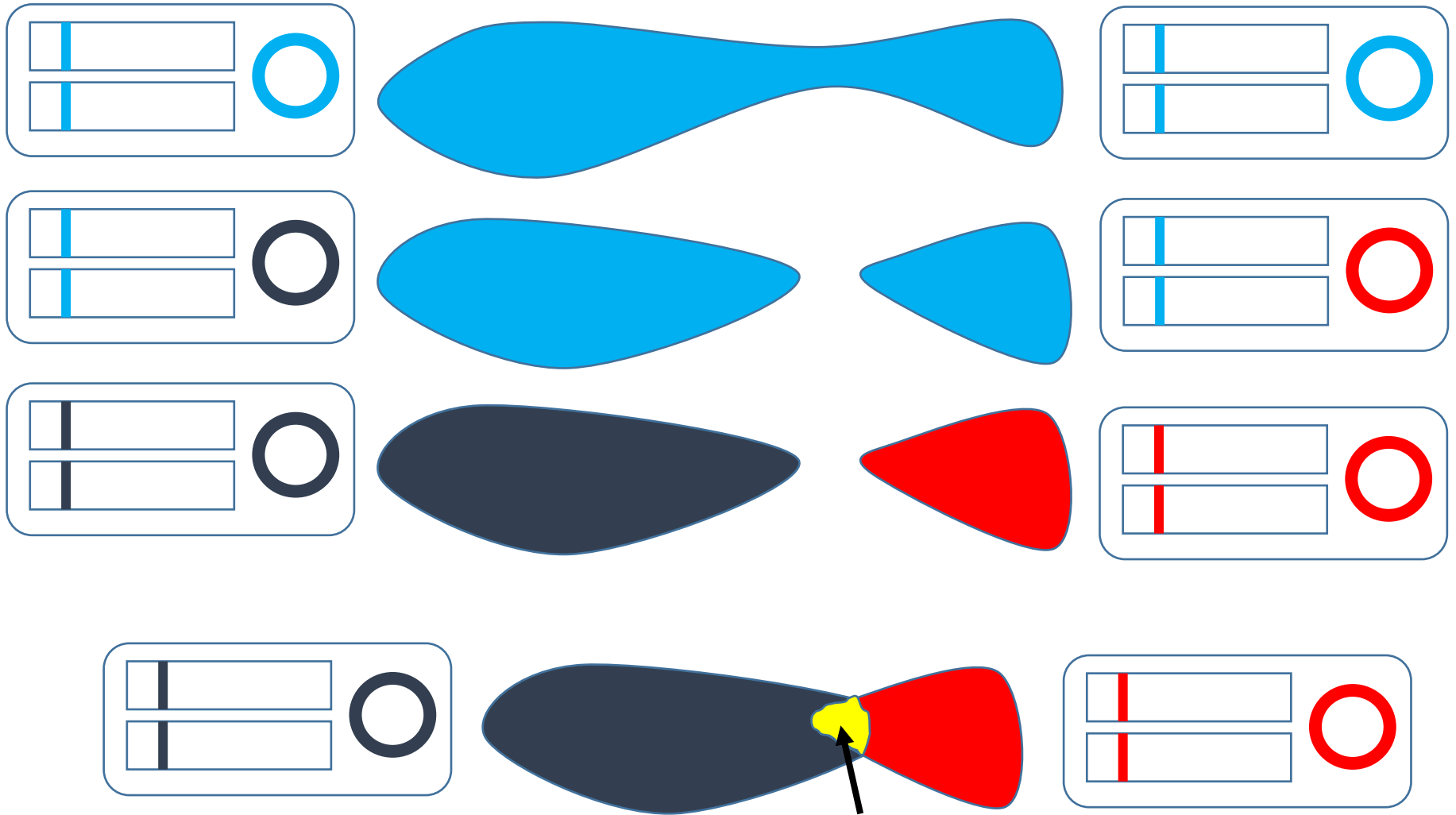

mitonuclear  
incompatibility

# Mitonuclear coevolution as the genesis of speciation

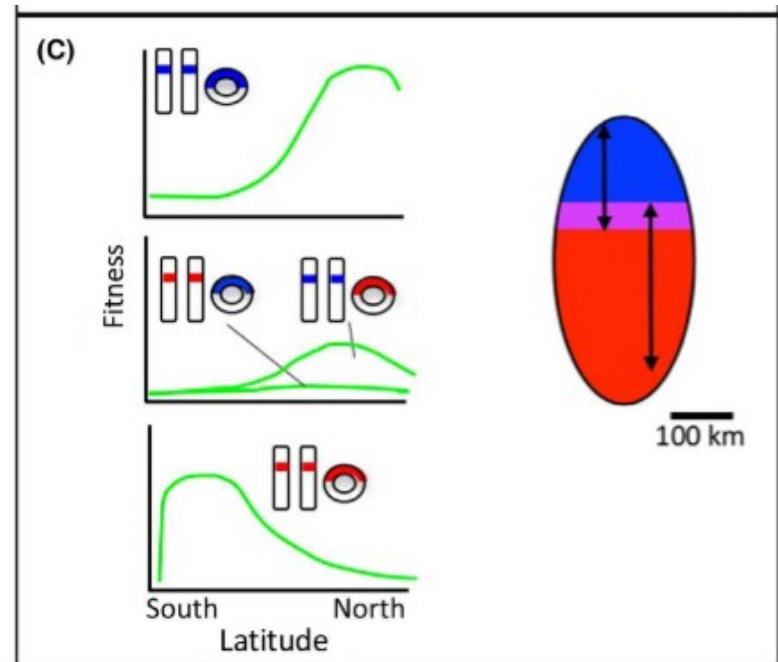
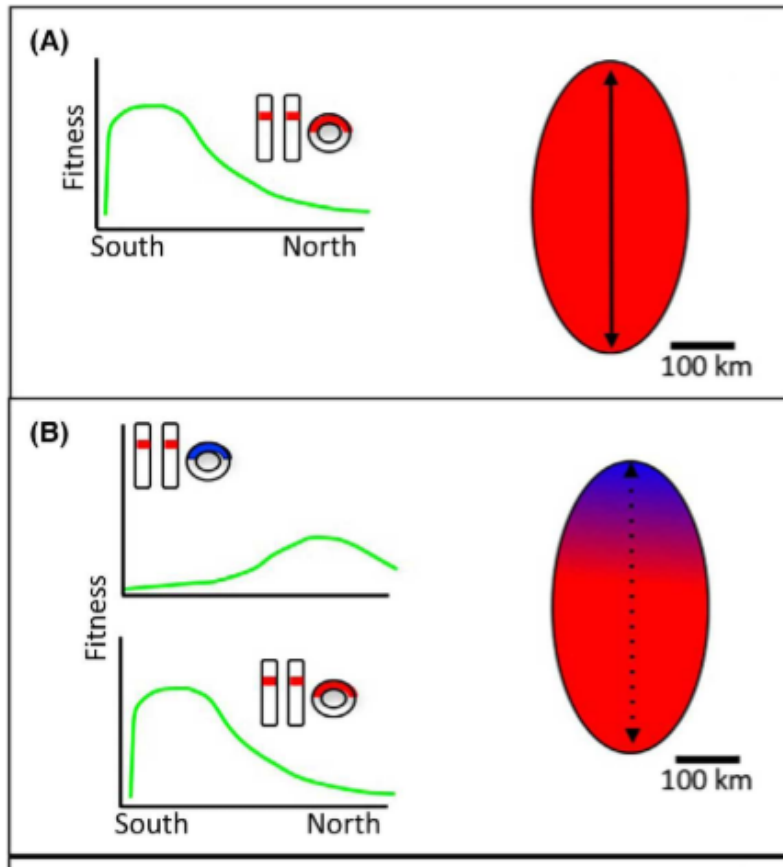

# Mitonuclear compatibility species complex

- = a species is a population that is genetically isolated from other populations by incompatibilities in uniquely coadapted mt and N-mt genes
- the need of mitonuclear coadaptation is **universal** among eukaryotes
- species boundaries become objective and defensible
- determining species boundaries would no longer be an esoteric intellectual exercise
- „species“ is **exclusively a eukaryotic concept**



# Biological identifications through DNA barcodes

Paul D. N. Hebert\*, Alina Cywinska, Shelley L. Ball  
and Jeremy R. deWaard

Department of Zoology, University of Guelph, Guelph, Ontario N1G 2W1, Canada

first idea in 2003

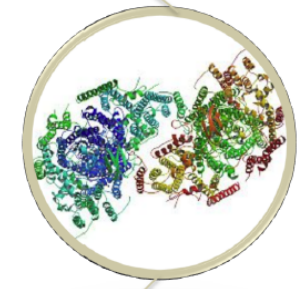
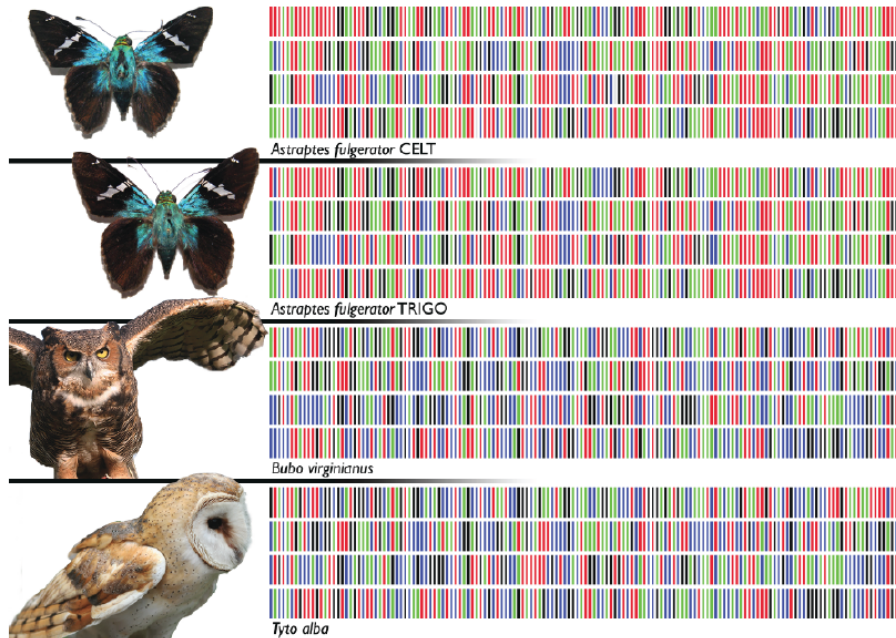
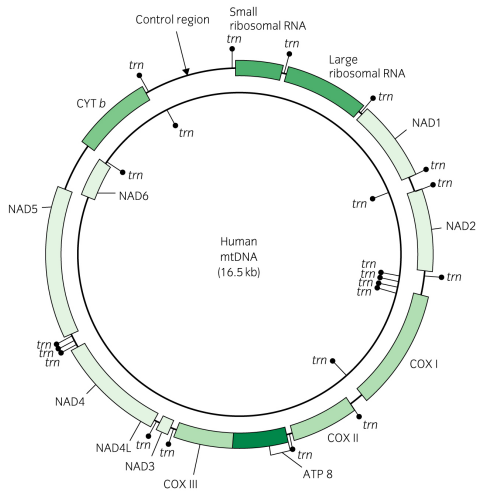

„DNA barcode“ – short fragment of mitochondrial DNA

# Introgression/replacement of mtDNA in *Myotis*

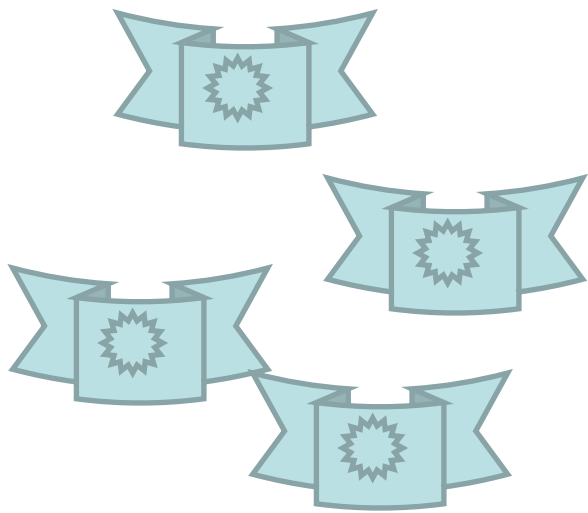

*Myotis myotis* - Europe

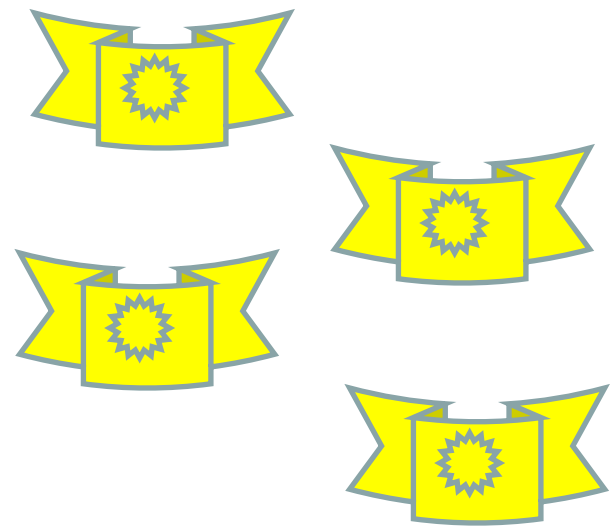

*Myotis blythii* - Asia



# *Myotis blythii* vs. *Myotis myotis* - mtDNA replacement

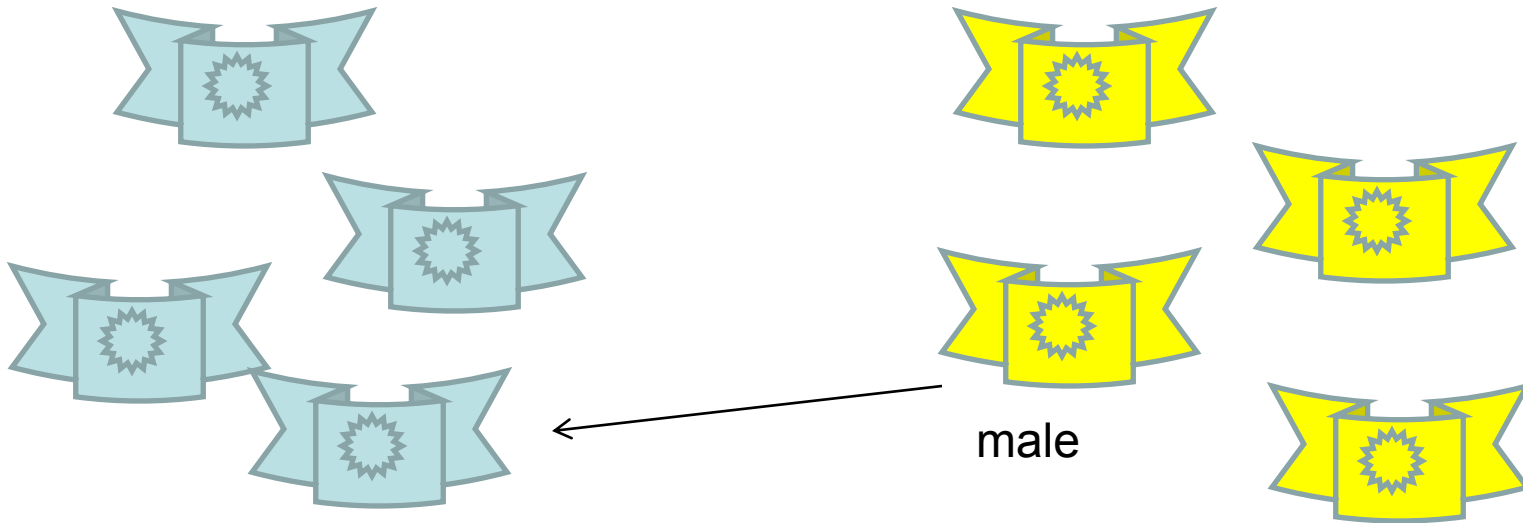

*M. myotis* - Europe

*M. blythii* - Asia



# *Myotis blythii* vs. *Myotis myotis* - mtDNA replacement

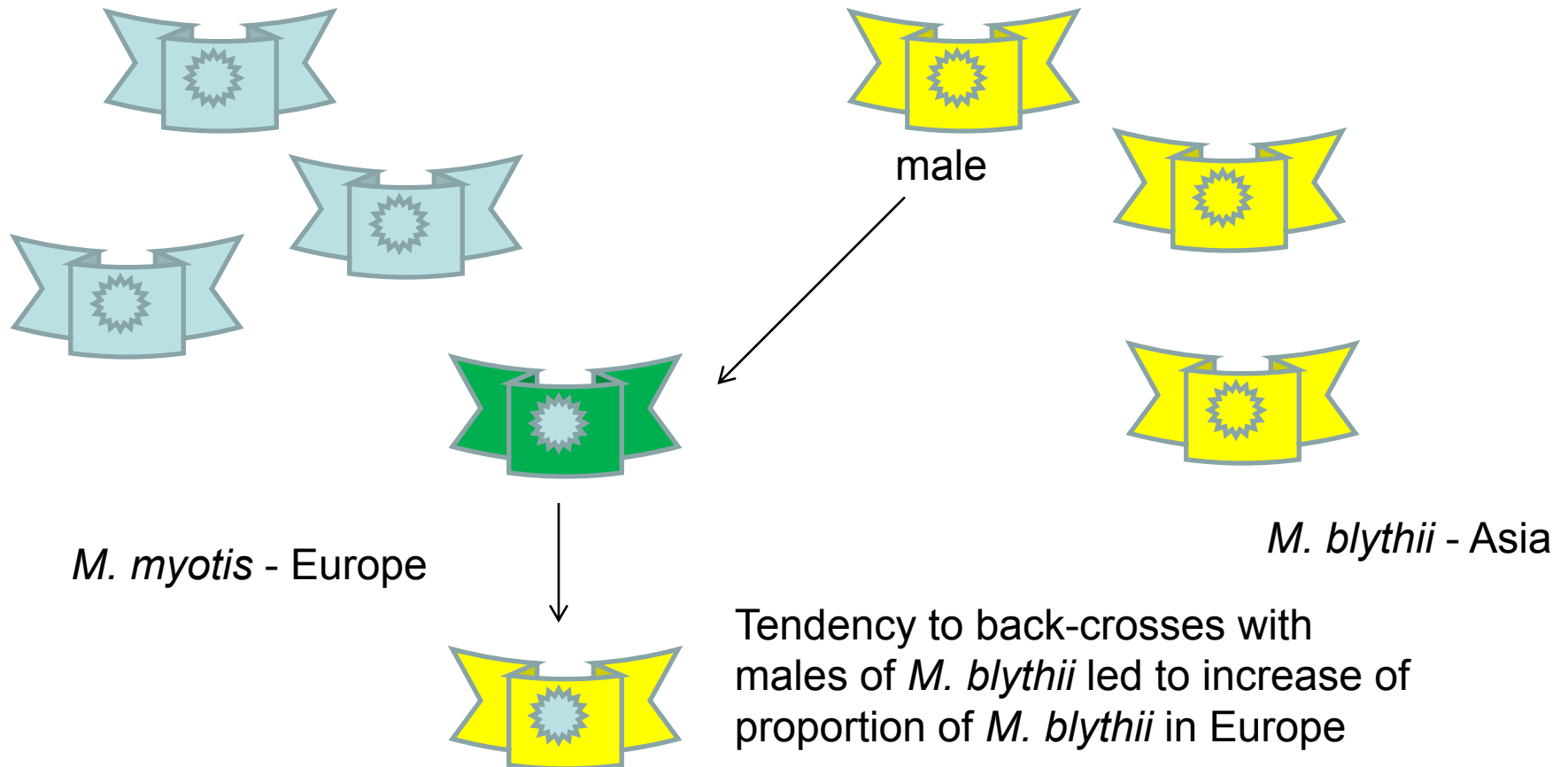

Colonizing (invasive) species often adopt mtDNA of original species (Currat et al. 2008)

# Hares in Spain and Portugal

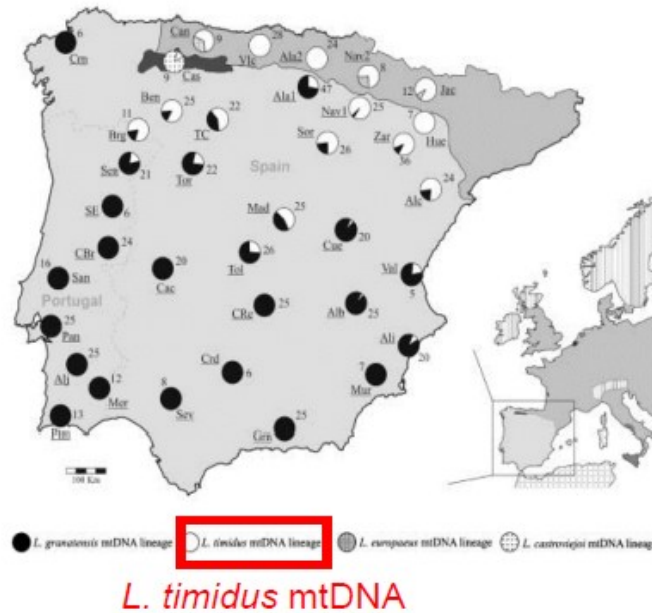

- three species of *Lepus* in Iberia have often mtDNA of *L. timidus*
- but *L. timidus* disappeared from Iberia at the end of last glacial period
- neutral process – consequence of spatial expansion



mtDNA



*L. europaeus*



# Interspecific mtDNA introgressions in *Lophuromys*

ddRADseq

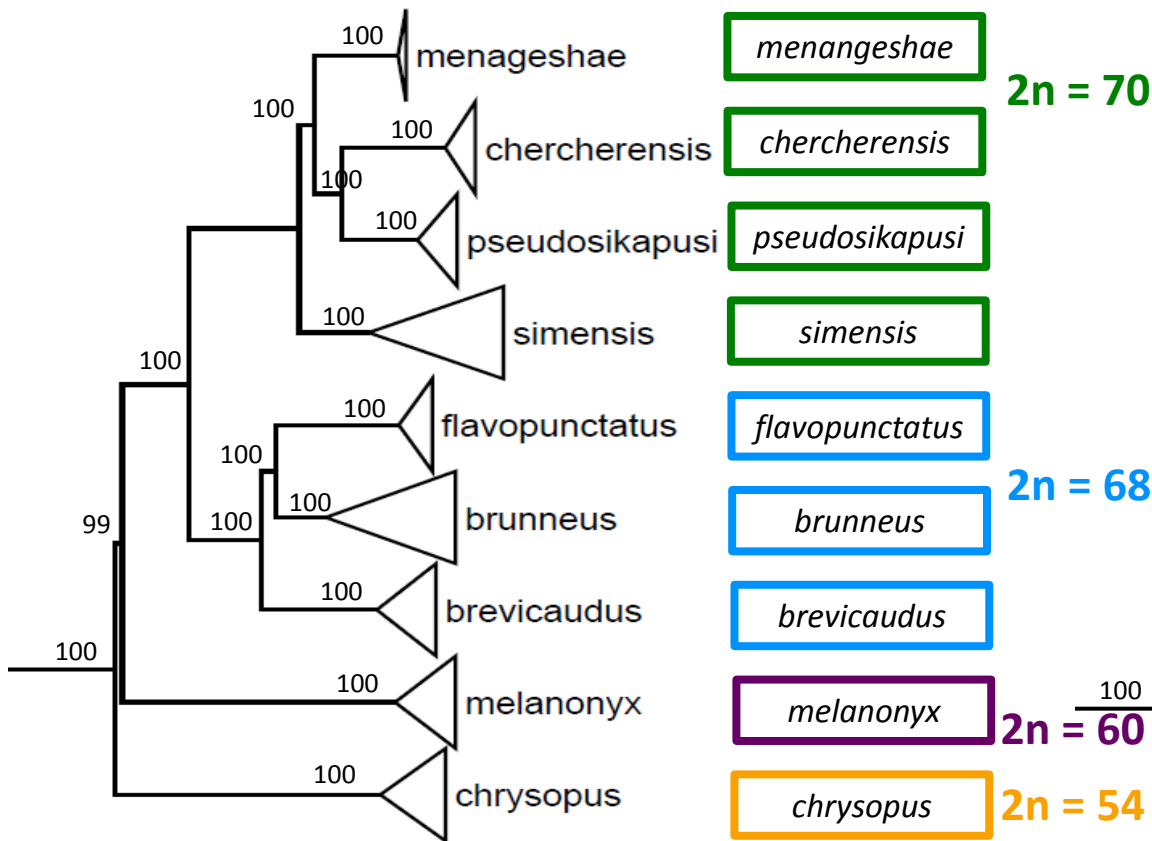

15 623 informative loci



mtDNA

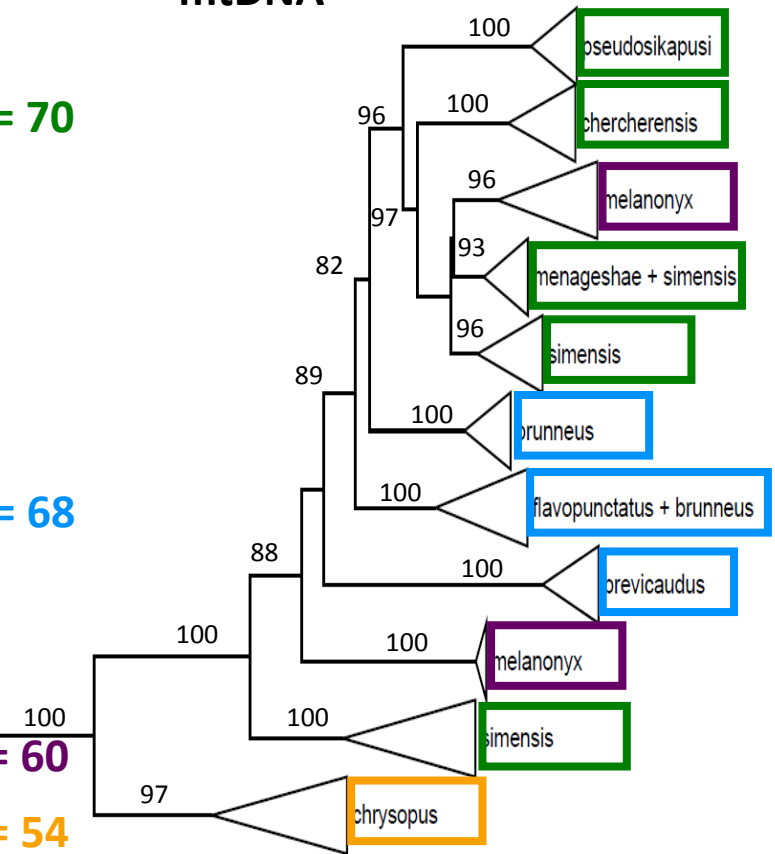

cytochrome *b* (1140 bp)

# Interspecific mtDNA introgressions in *Lophuromys*

ddRADseq

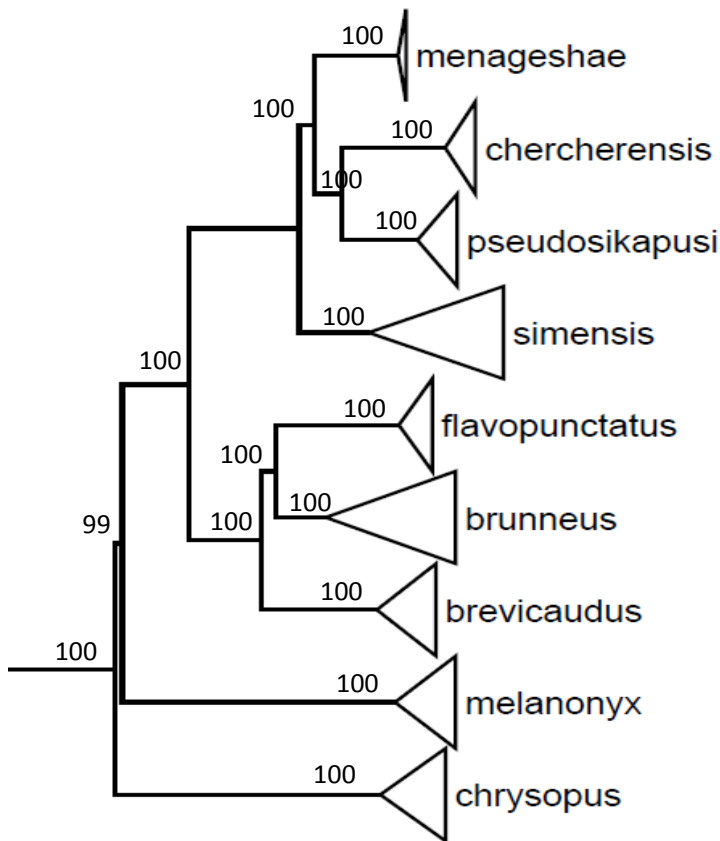

15 623 informative loci

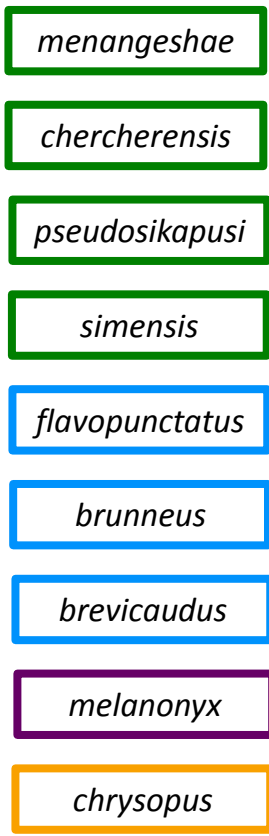

mtDNA

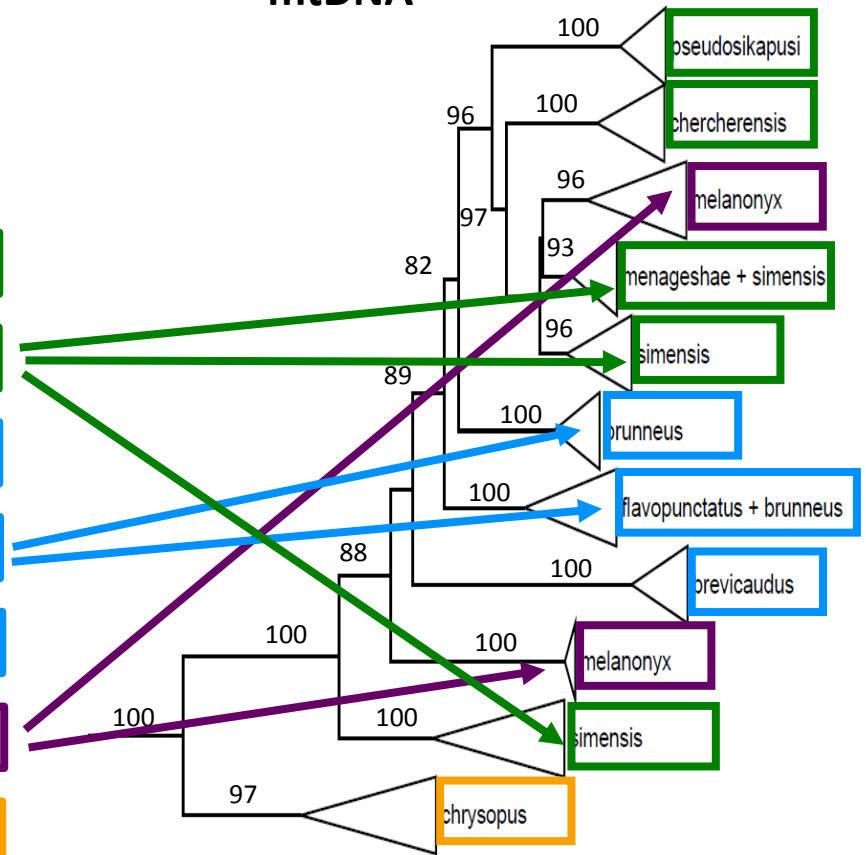

cytochrome *b* (1140 bp)



# Interspecific mtDNA introgressions can be surprisingly frequent

Borena Saynt National Park  
(central Ethiopia)

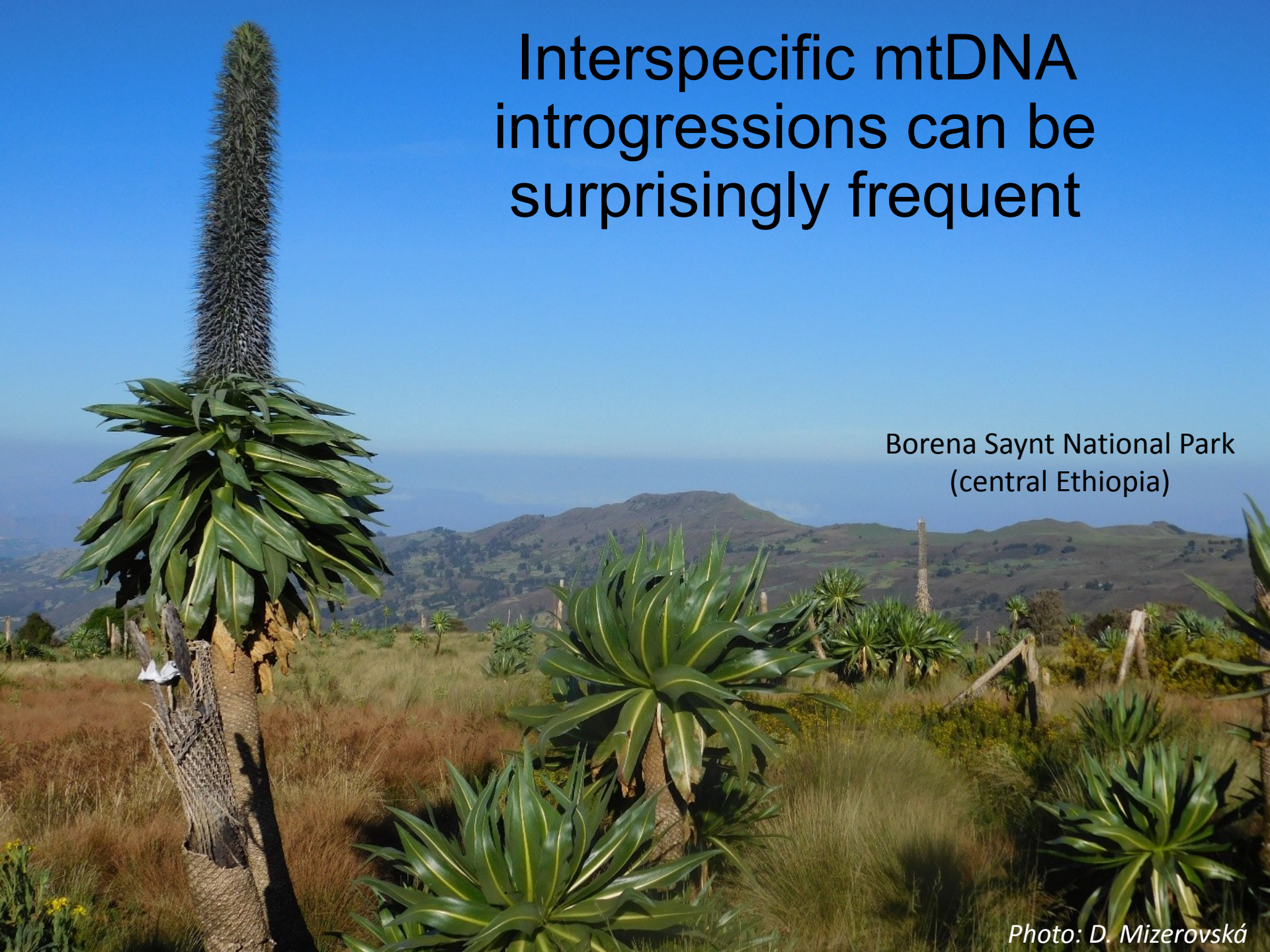

*Photo: D. Mizerovská*



*Stenocephalemys*  
(Ethiopian endemics)

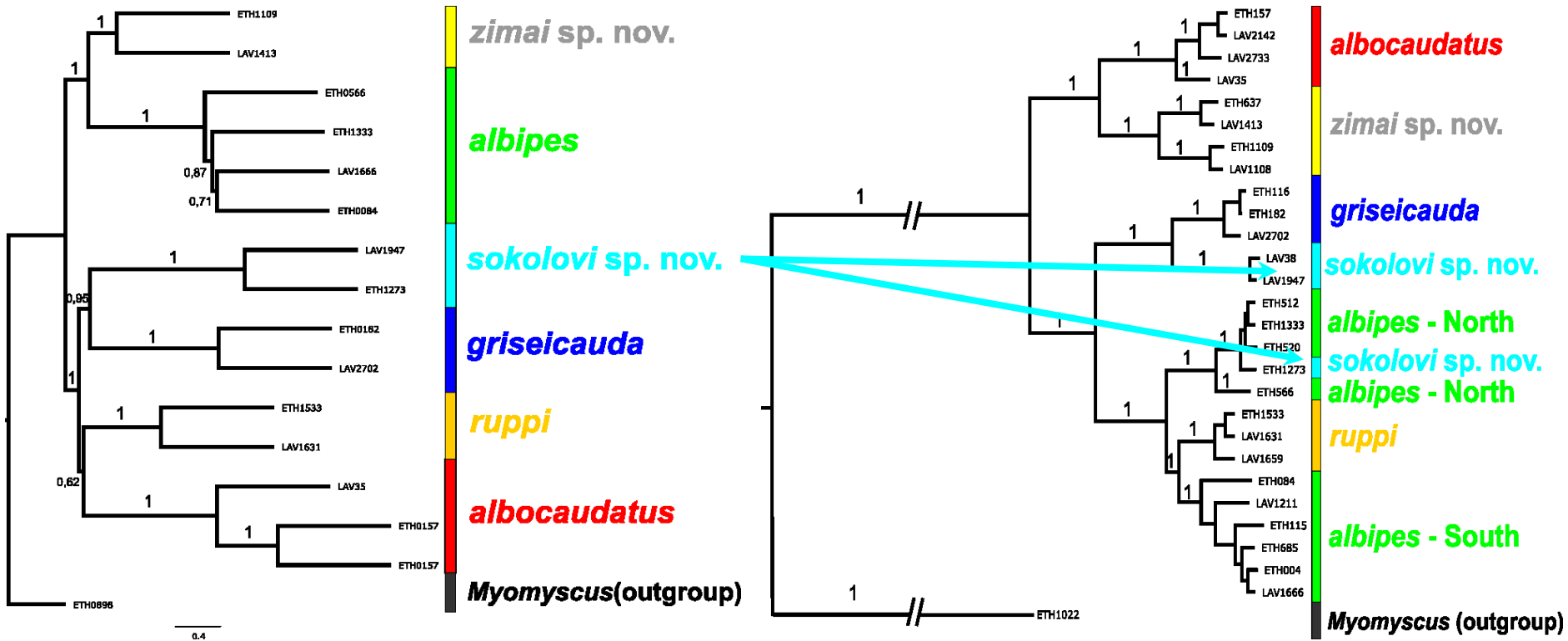

(A) anchored phylogenomics  
(388 nuclear loci)

(B) complete mitogenomes



# Borena Saynt NP



*Stenocephalemys*

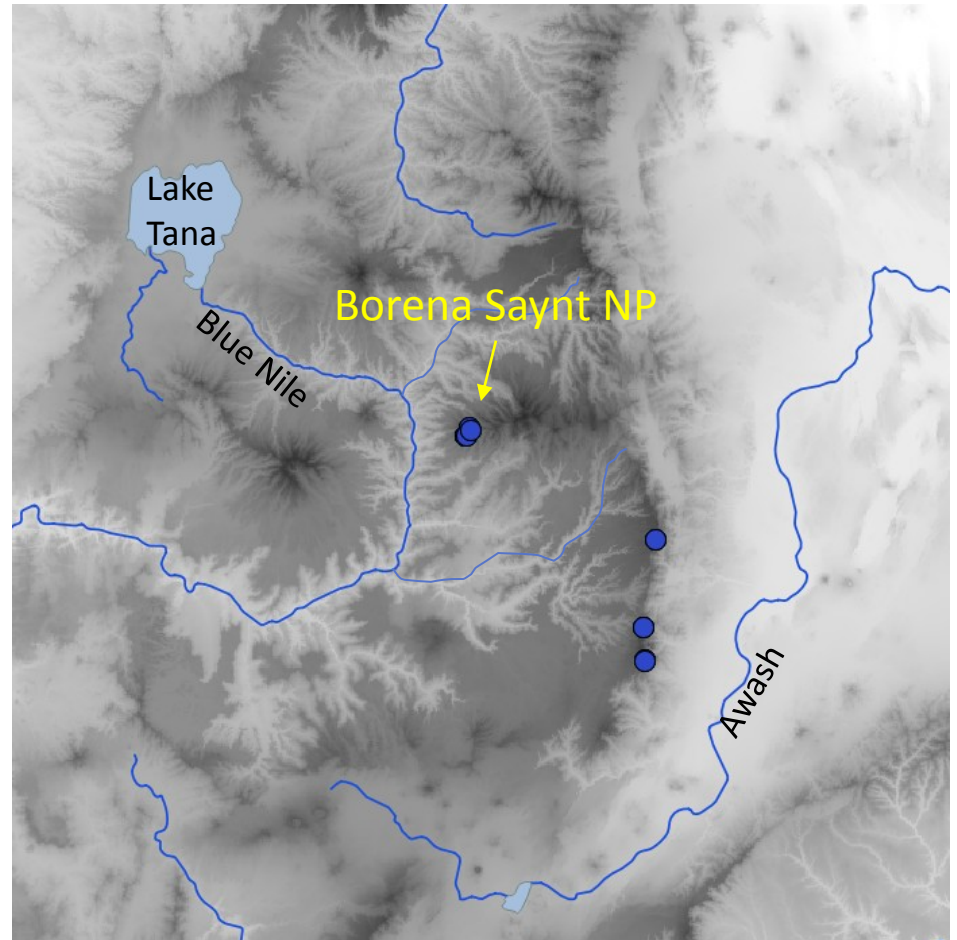

● Distribution of *S. sokolovi* sp. nov.

# Borena Saynt NP

3500 m a.s.l.



2800 m a.s.l.



*Stenocephalemys*

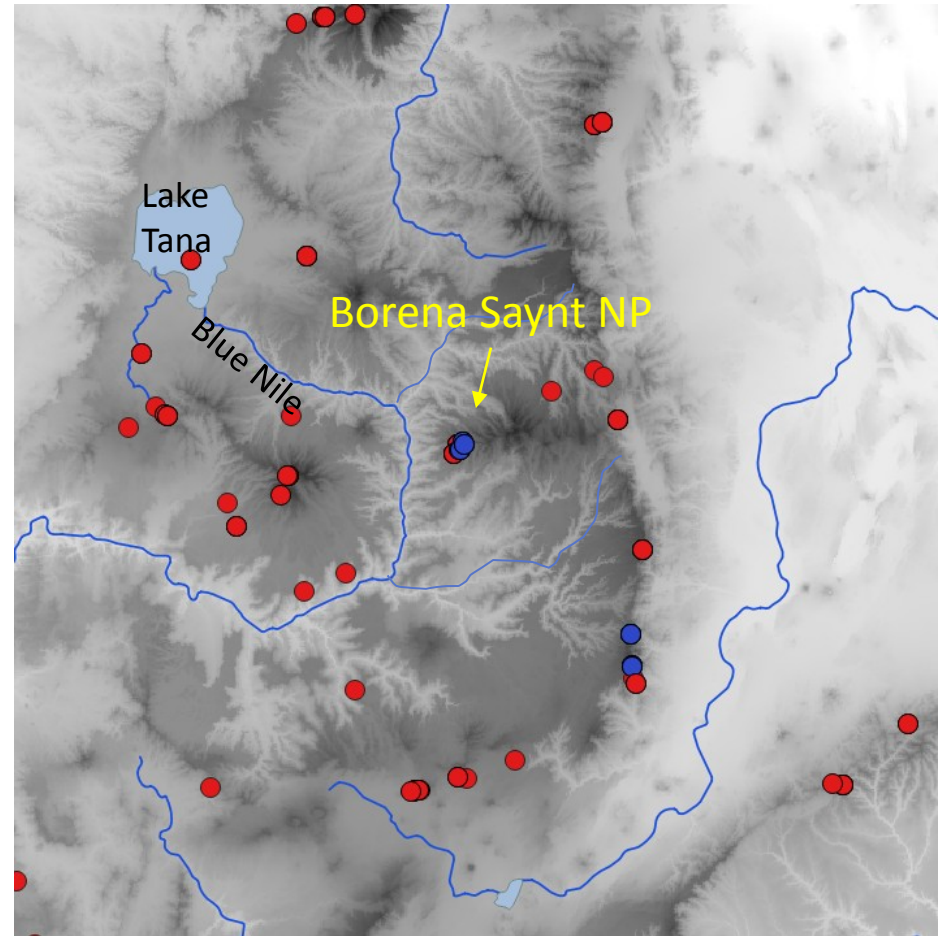

- Distribution of *S. sokolovi* sp. nov.
- Distribution of *S. albipes*

# Borena Saynt NP

anchored phylogenomic

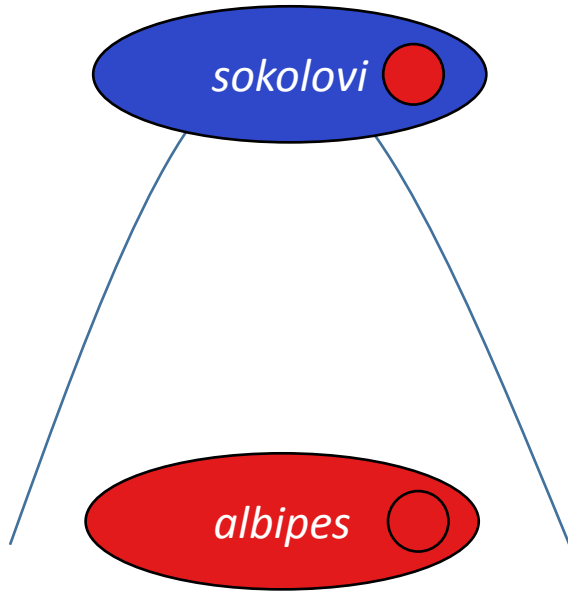

*Stenocephalemys*  
(Mizerovská et al. 2020)

ddRADseq

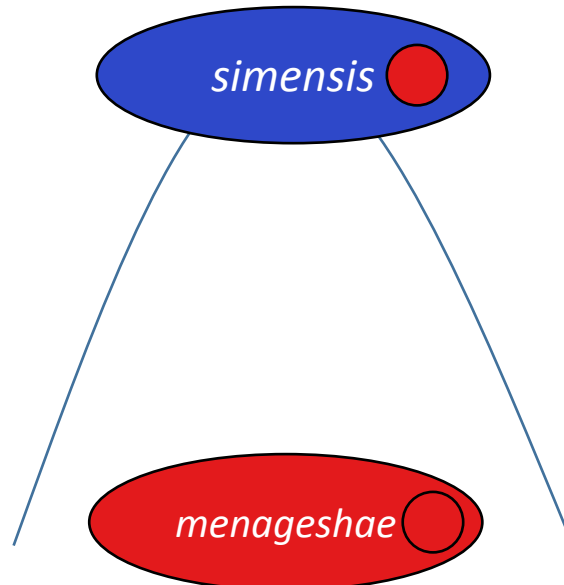

*Lophuromys*  
(Komarova et al. 2021)

ddRADseq

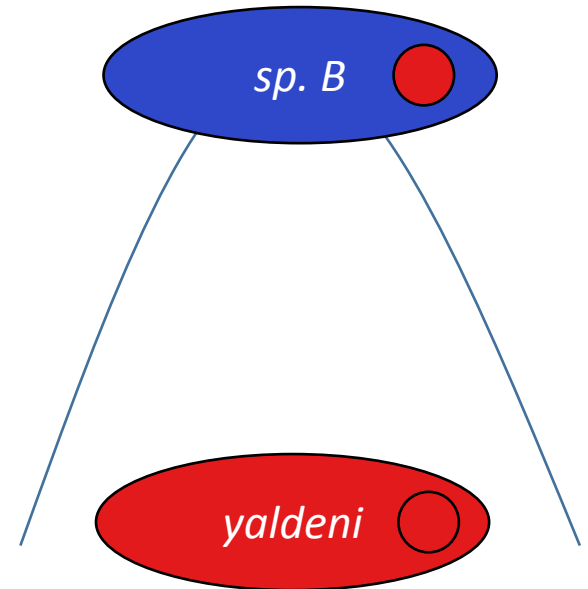

*Crocidura*  
(Konečný et al. 2020)

# Possible evolutionary explanations

## Non-adaptive explanation

- rodents have male-biased dispersal – expanding males captures mtDNA of local species (see examples of hares or bats)
- expansion due to climate change → low-elevation species should move up and capture high-elevation mtDNA

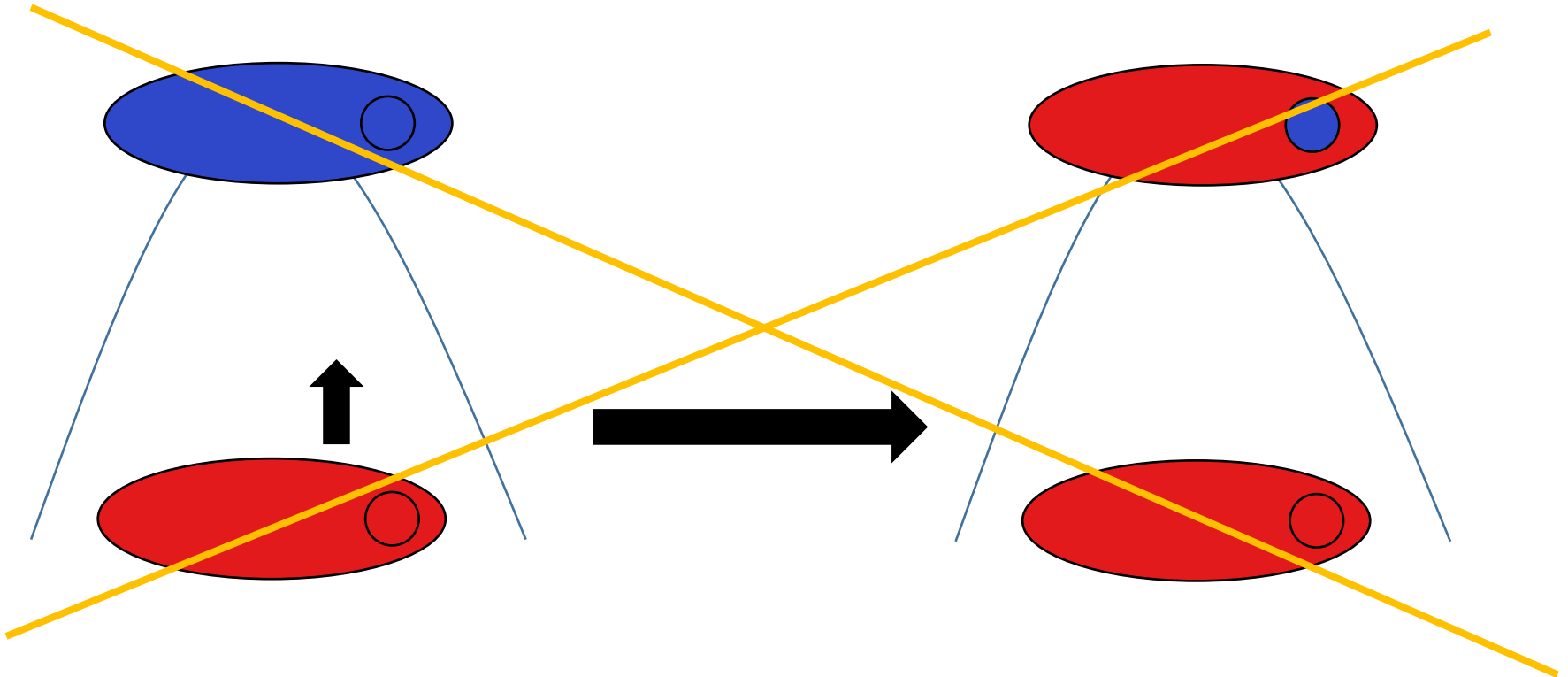



# Possible evolutionary explanations

## Adaptive explanation no. 1

- advantageous OXPHOS genes of low-elevation taxon
- → studies of energetic metabolism and co-introgression are required

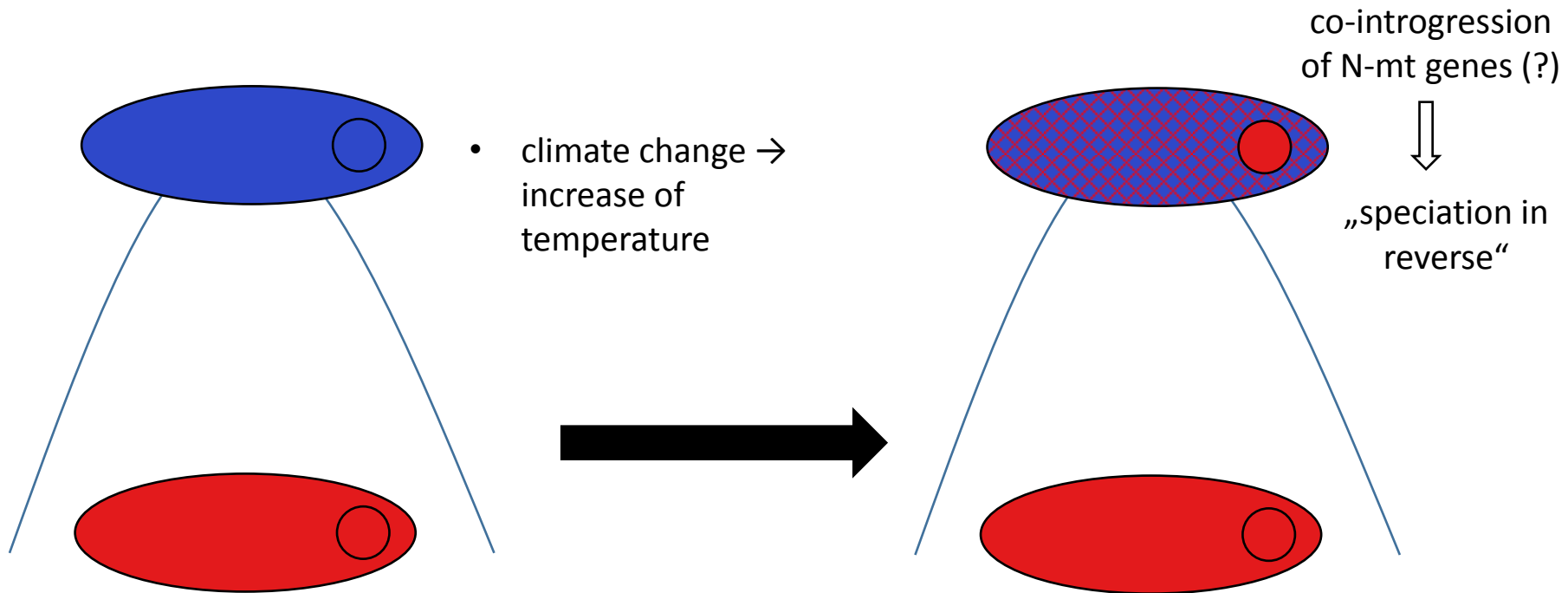



# Possible evolutionary explanations

## Adaptive explanation no. 2

- „mutational erosion“ - replacement of non-functional high-elevation mtDNA (accumulation of mutations in small populations in fragmented Afroalpine habitats) – „best of bad options“

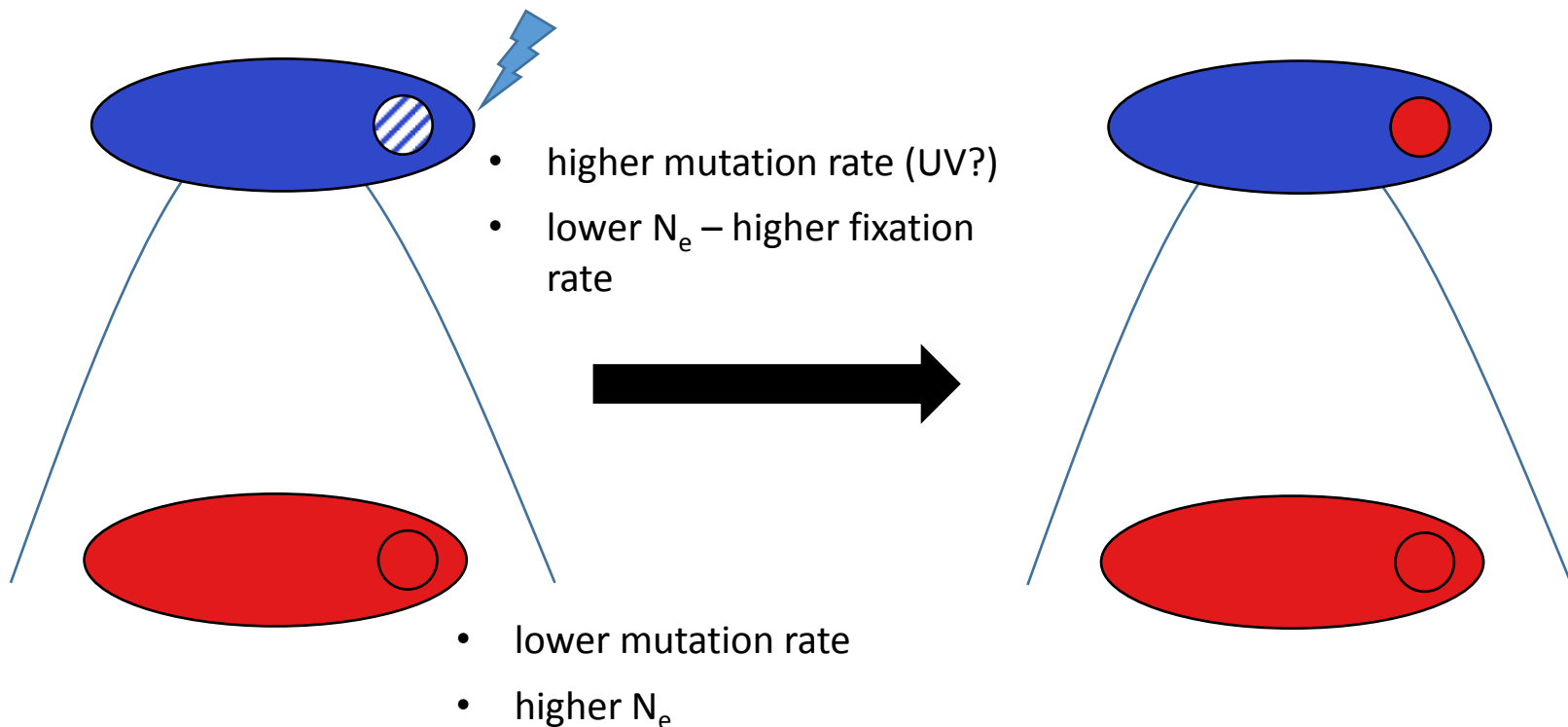

# CONCLUSIONS

# Conclusions

- species concepts and species delimitations are **crucial parts of biodiversity studies**
- enormous value in applied **conservation biology**
- **genomics can be useful** tool for species delimitation (analytical approaches still in development) – once they will be able to discriminate between population- and species-level structuring
- mitonuclear compatibility species concept is a good candidate for a **unifying species concept**