

Bi9393 Analytická cytometrie



Biofizikální ústav AVČR
Královopolská 135
612 65 Brno

e-mail: ksoucek@ibp.cz
tel.: 541 517 166

Karel Souček, Ph.D.

Lukáš Kubala, Ph.D., doc.

Soňa Legartová, Ph.D.

Alena Hyršlová Vaculová, Ph.D., doc.

Mgr. Radek Fedr

Cytometrie



WIKIPEDIE
Otevřená encyklopedie

- Cytometrie je souhrnné označení pro skupinu metod používaných pro měření různých charakteristik buněk. Proměnné, které lze měřit cytometrickými metodami, zahrnují velikost buňky, počet buněk, morfologii buněk (tvar a strukturu), fáze buněčného cyklu, obsah DNA a přítomnost či nepřítomnost specifických proteinů na buněčném povrchu nebo v cytoplazmě. Cytometrie se používá k charakterizaci a počítání krevních buněk v běžných krevních testech, jako je úplný krevní obraz. Podobným způsobem se cytometrie také používá ve výzkumu buněčné biologie a v lékařské diagnostice (například k odhalování rakoviny či AIDS).

Existují různé typy cytometrie:

- Průtoková cytometrie
- Spektrální průtoková cytometrie
- Hyperspektrální cytometrie
- Obrazová cytometrie
- Hmotnostní cytometrie
- Cytometrie *in vivo* (neinvazivní cytometrie)

Ref. [What is Cytometry?](#). International Society for Advancement of Cytometry. 2013-03-28



Struktura kurzu

- **Přednášky**
 - 9 lekcí o průtokové cytometrii a aplikacích
 - 1 lekce o mikroskopických technikách
 - 1 lekce o základech analýzy obrazu
 - 2 lekce studentských prezentací
- **Bi9393c Analytická cytometrie-cvičení**, 4 dny v bloku, od **8.1. nebo od 15.1. 2023**
- Navazuje na přednášky z oblasti průtokové cytometrie, blokově ve skupinách
- **Test**

Kurz bude zakončen zkouškou ve formě testu shrnujícího látku za celý semestr. Výsledek testu bude tvořit 75% celkového hodnocení.
- **Seminář**

Každý student bude prezentovat krátký seminář jehož téma bude konzultováno s přednášejícím a bude se týkat zaměření kurzu. Na základě této prezentace bude udělen zápočet a hodnocení vlastního semináře se bude také z 25-ti % odrážet v celkové známce.



Seminář studentů

- Téma semináře: **Jak ve své DP/DSP používám/chci použít/ mohl bych použít metody analytické cytometrie.**
- Cílem je demonstrovat pochopení principů ze kterých vychází a jejich uplatnění v biologii.
- Prezentace musí být připravena např. v PowerPoint(u). Prezentaci je **doporučeno předložit v předstihu** přednášejícímu ke konzultaci a posouzení.
- Délka prezentace je 5 minut (~ 2 min představení podstaty Vaší experimentální práce) + diskuse

Informační zdroje – průtoková cytometrie

- Practical Flow Cytometry, Howard M. Shapiro, Wiley-Liss; 4th edition
- Cytometry: New Developments, Volume 75, Fourth Edition (Methods in Cell Biology), Zbigniew Darzynkiewicz, Academic Press; 4th edition
- Flow Cytometry with Plant Cells: Analysis of Genes, Chromosomes and Genomes; Jaroslav Dolezel (Editor), Johann Greilhuber (Editor), Jan Suda (Editor), February 2007
- Single Cell Analysis, J. Paul Robinson, Andrea Cossarizza, 2017

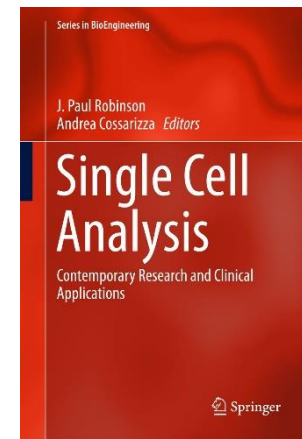
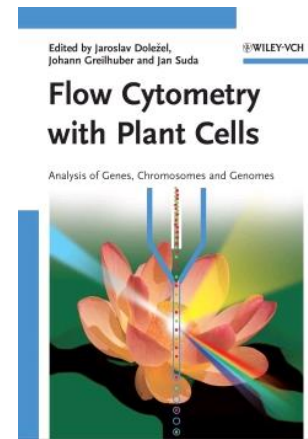
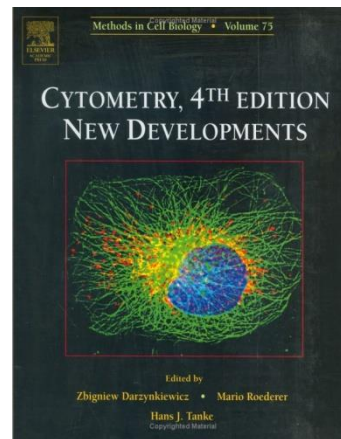
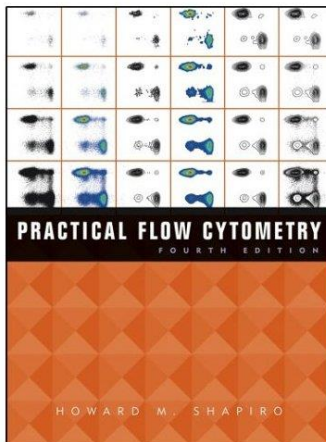

Více informací o knihách o průtokové cytometrii najdete na:
<http://www.cyto.purdue.edu/flowcyt/newbook.htm>

https://www.beckman.com/resources/reading-material/ebooks/practical-flow-cytometry



Q Search

Shop & Products ▾ Resources ▾ Service ▾ Support ▾ About Us ▾

Home > Resources > Reading Material > eBooks > Practical Flow Cytometry

Practical Flow Cytometry, 4th Edition



Howard Shapiro

Sponsored by Beckman Coulter Life Sciences Advancing Flow Cytometry

Beckman Coulter is proud to make available Howard M. Shapiro, M.D., P.C.'s Practical Flow Cytometry, 4th Ed. This is the go to reference for anyone interested in developing expertise in flow cytometry applications. As part of our ongoing support for the advancement of flow cytometry applications we are proud to sponsor free digital downloads. Complete the form to activate your eBook and sign up for additional alerts related to flow cytometry innovations or educational content.

You'll receive:

- Practical Flow Cytometry, 4th Ed
- Key Flow Cytometry Updates
- Invitations to Webinars
- Info on New Beckman Products
- And Much More!

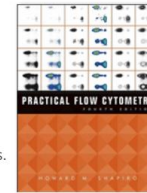

eBook Download: Practical Flow Cytometry

* First Name

* Last Name

* Company

* Email

* Country

* Postal Code

Please keep me informed about Beckman Coulter webinars, products, goods, and services, including products, goods, or services from our related companies.

* By Email: I Consent
 I DO NOT Consent

* By Phone: I Consent
 I DO NOT Consent

By submitting this form I confirm that I have reviewed and agree with the [Privacy Policy](#) and [Terms of Use](#). I also understand my privacy choices as they pertain to my personal data as provided in the [Privacy Policy](#) under "Your Privacy Choices".

Get Your Free eBook

Informační zdroje – průtoková cytometrie (metody a protokoly)

- The Handbook of Flow Cytometry Methods
- Current Protocols in Cytometry
- Company web pages, e.g.
 - <https://www.thermofisher.com/cz/en/home/references/protocols.html>
 - <https://www.thermofisher.com/cz/en/home/references/protocols/cell-and-tissue-analysis/flow-cytometry-protocol.html>

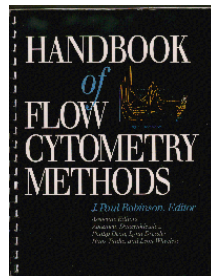
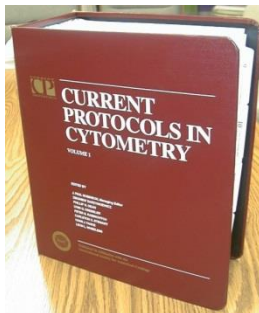

Informační zdroje – cytometrie (časopisy)

■ Cytometry Part A

<https://onlinelibrary.wiley.com/journal/15524930>



■ Cytometry Part B: Clinical Cytometry

<https://onlinelibrary.wiley.com/journal/15524957>



Informační zdroje - mikroskopie

- Taatjes D. J. Cell Imaging Techniques, Methods and Protocols, Humana Press, Totowa, New Jersey, 2005
- Stephens D. Cell Imaging, Scion Publishing Ltd., 2006.
- Pawley, J. (Ed.), Handbook of Biological Confocal Microscopy, 3rd ed., 2006
- Fluorescence Microscopy: From Principles to Biological Applications
- Ulrich Kubitscheck (Editor), ISBN: 978-3-527-32922-9, 2013, Wiley-Blackwell

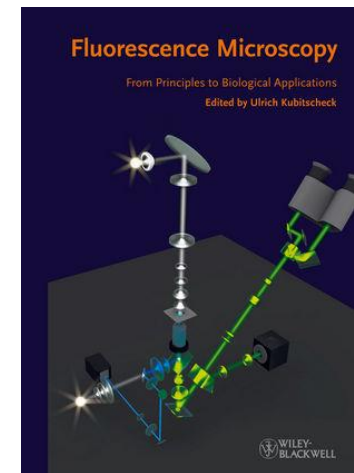
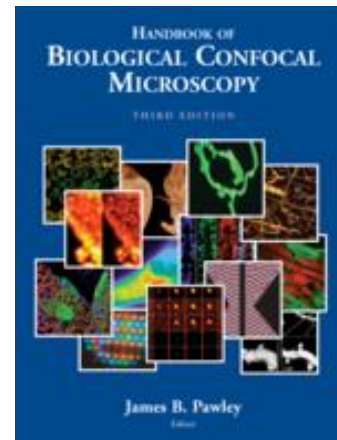
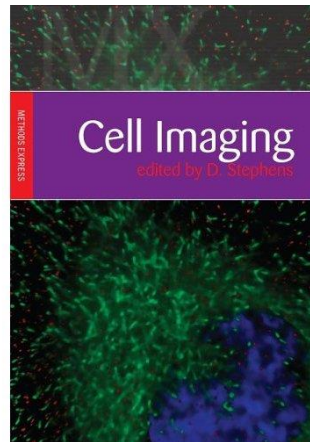
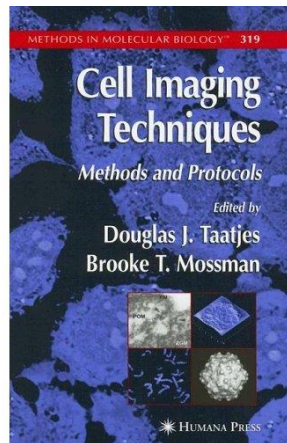

Informační zdroje – (Internet)

- Purdue University, Cytometry Labs

<http://www.cyto.purdue.edu/>

- International Society for Advancement of Cytometry

<http://www.isac-net.org/>

- Excyte

<https://expertcytometry.com>

- https://twitter.com/ISAC_CYTO

- <https://twitter.com/flowcytometryUK>

- <https://twitter.com/FlowJoNow>



Proč být členem ČSAC?

ČSAC pro své členy:

- organizuje konferenci Analytická cytometrie každé dva roky (s účastí vybraných zahraničních řečníků ze všech oblastí cytometrie)
- pořádá vzdělávací akce (např. Motolský Minikurz, B-klub a další)
- podporuje Vámi organizované cytometrické semináře (finančně, organizačně, odborně)
- uděluje ceny v soutěži o nejlepší publikaci s cytometrickou tematikou (cílem je zviditelnit zajímavé práce, poskytnout uznání kvalitním pracím)
- poskytuje cestovní granty ČSAC pro mladé členy na cytometrické akce
- informuje o aktivitách ISAC a ESCCA
- umožňuje kontakt s podobně zaměřenými kolegy a neformální výměnu zkušeností
- podporuje rozvoj cytometrie
- zprostředkovává výměnu zkušeností mezi členy a světovou cytometrickou komunitou

ČSAC je malou organizací a žije jen aktivitou svých členů.

Co můžete udělat Vy pro ČSAC:

- svým členstvím podpořit aktivity ČSAC
- aktivně nabídnout spolupráci na tématech, jež se Vás týkají
- zorganizovat seminář na téma, které Vám chybí
- pomoci s obsahem webových stránek (doplnit odkazy, přeložit do angličtiny)



Obecný úvod do průtokové cytometrie

- Základní principy, možnosti průtokové cytometrie a její aplikace
- Historie

Tyto částice mají něco společného ...

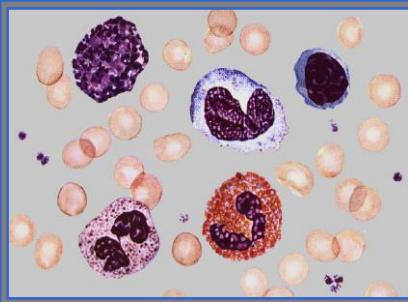

Blood cells



Chromosomes



Algae

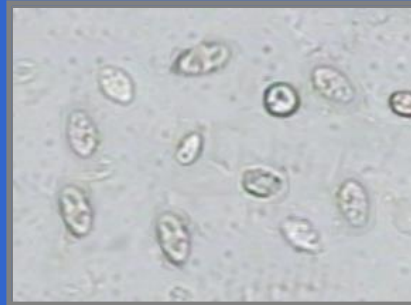

Protozoa

... určité parametry těchto částic mohou být měřeny pomocí průtokové cytometrie.

Komerční zařízení a vývoj

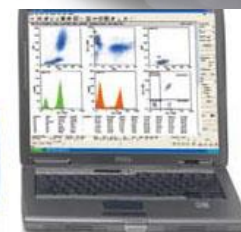
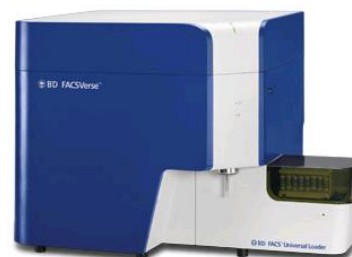
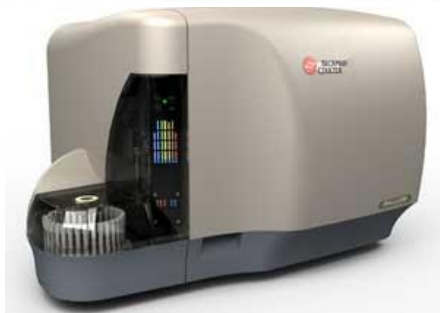
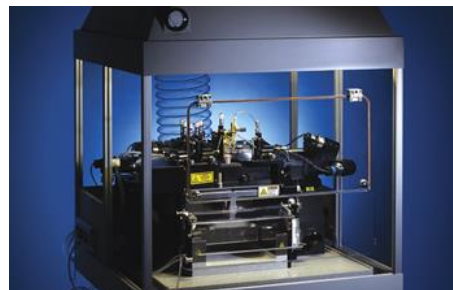

5 Steps to your flow cytometry panel

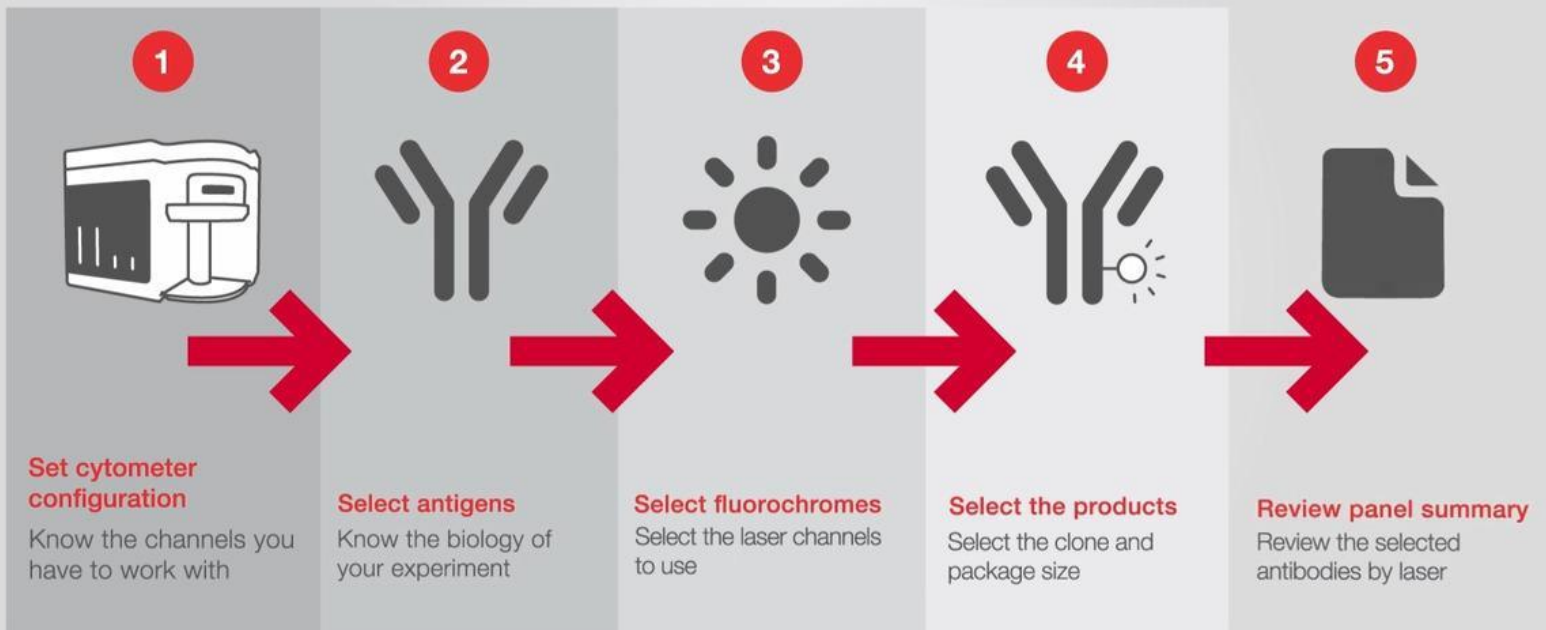

Co je průtokový cytometr?

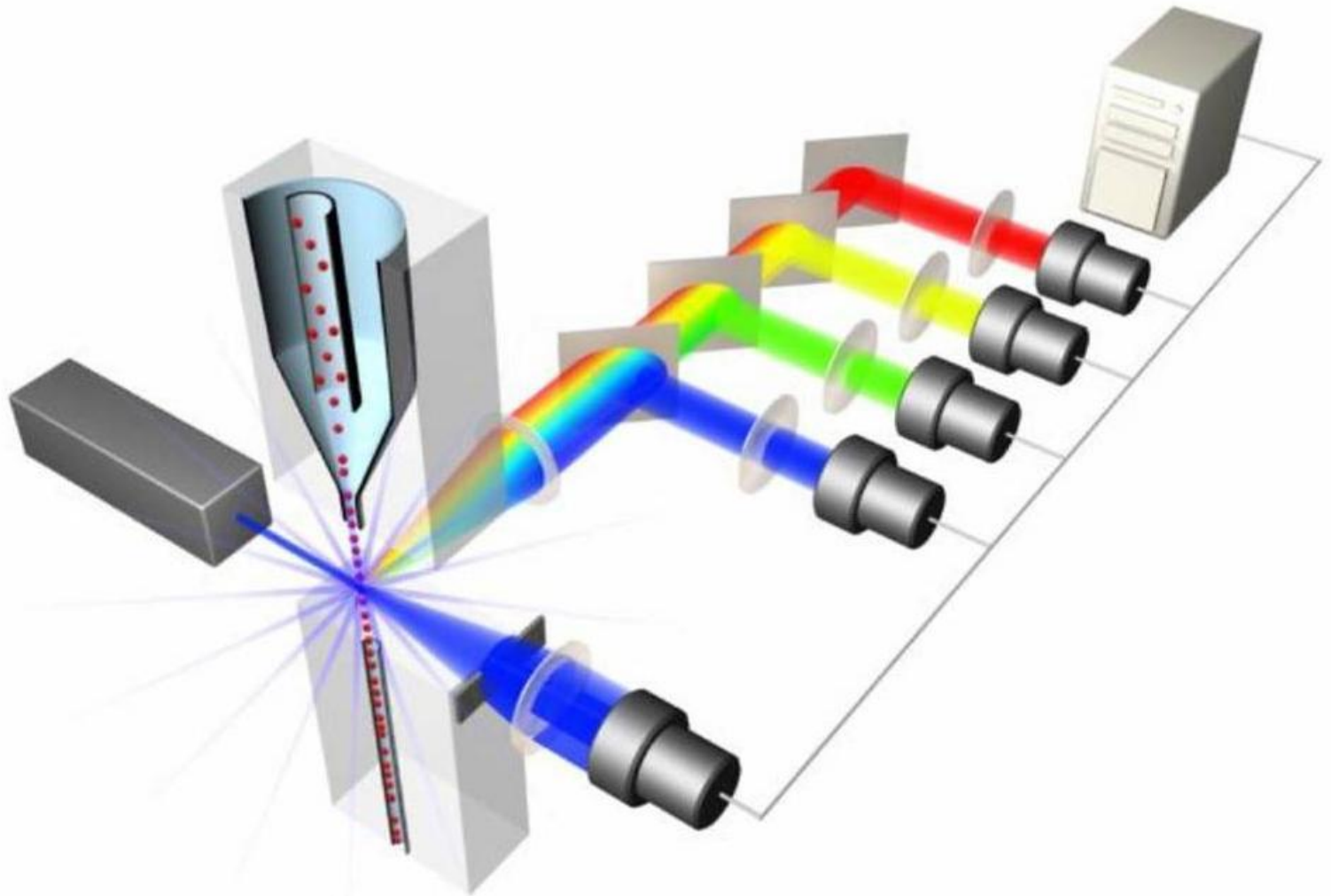

Co můžeme analyzovat pomocí průtokové cytometrie?

- Počítat částice v suspenzi
- Kvantifikovat rozptyl světla, a **intenzitu fluorescence na úrovni jednotlivých buněk**
- Hodnotit 10^5 až 10^6 částic za méně než 1 minutu
- Fyzicky separovat jednotlivé částice (definované populace i jednotlivé buňky) pro další analýzu



Jaké jsou principy?

- **Rozptyl světla (Light scatter)** pomocí laseru nebo UV lampy
- Detekce specifické fluorescence nebo celého spektra
- **Hydrodynamicky** zaostřený proud částic
- **Elektrostatická** separace částic
- Možnost **multivariační** analýzy dat



Definice

■ Průtoková cytometrie (flow cytometry)

- Meření vlastností proudících částic (buněk)
- také známo jako **Fluorescence-Activated Cell Sorting (FACS)**

■ Průtoková separace (flow sorting)

- fyzická separace částic (buněk) na základě parametrů měřených průtokovou cytometrií



Technické součásti

- Zdroje světla
- Detekční systémy
- Fluidní systém
- Separace
- Sběr dat
- Analýza dat



Technické součásti

■ Detekční systémy

Fotonásobiče (Photomultiplier Tubes (PMTs))

dříve 1-2

nyní >8

Diody

dříve detekce rozptylu světla (light scatters)

nyní i detekce fluorescence

■ Zdroje světla

Lasery (350-363, 420, 457, 488, 514, 532, 600, 633 nm)

Argon ion, Krypton ion, HeNe, HeCd, Yag

UV (Arc) Lampy

Mercury, Mercury-Xenon



Netechnická část je neméně důležitá ...

- (ne)specifické značky/sondy
- protilátky
- biomarkery
- příprava, zpracování materiálu/vzorků/tkání
- ...

Historie barvení biologických materiálů

Až do poloviny 19. století – *byly používány pouze přírodní barviva*

Anton van Leeuwenhoek použil v roce 1719 šafrán na obarvení svalových buněk

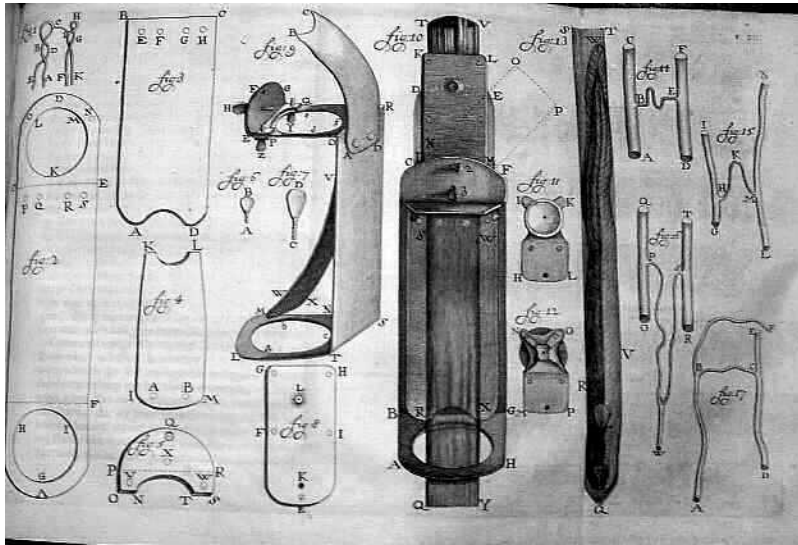

Leeuwenhoek
Microscope
(circa late 1600s)



Historie barvení biologických materiálů

Paul Ehrlich - 1879 použil kyselá a zásaditá barviva pro odlišení acidofilních, eosinofilních a neutrofilních leukocytů

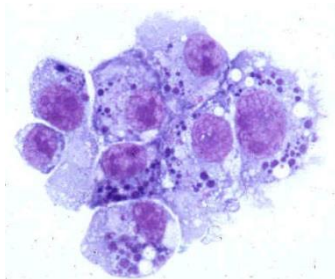

Clin Lab Med. 1993 Dec;13(4):759-71.

The Ehrlich-Chenzinsky-Plehn-Malachowski-Romanowsky-Nocht-Jenner-May-Grunwald-Leishman-Reuter-Wright-Giemsa-Lillie-Roe-Wilcox stain. The mystery unfolds.

Woronzoff-Dashkoff KP.

Historie barvení biologických materiálů

Princip fluorescenčního mikroskopu - August Köhler - 1904



August Köhler
(1866-1948)

Köhler's Original Woodcut

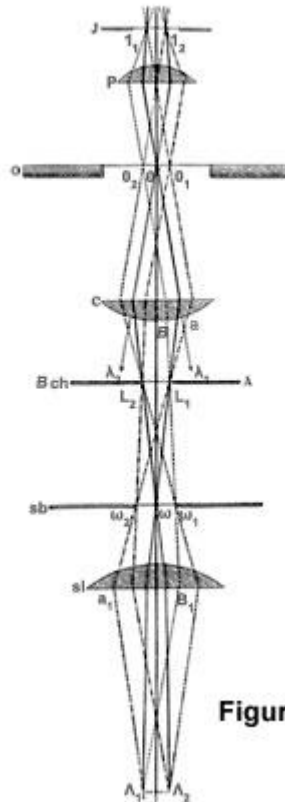
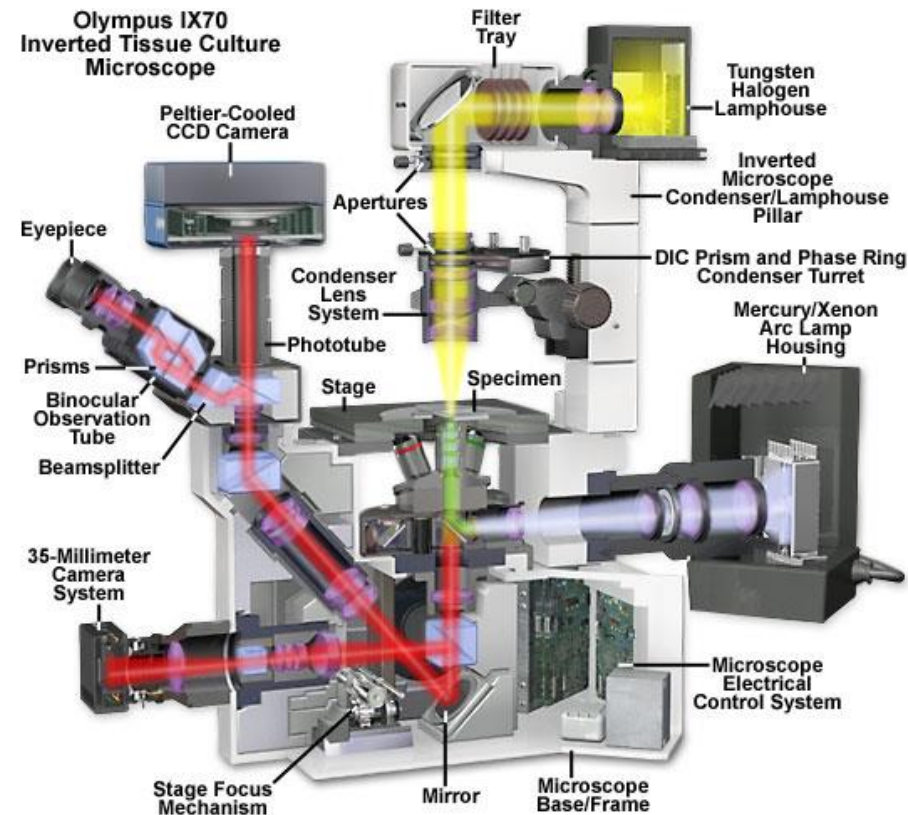

Figure 1



Andrew Moldavan

Není jasné zda
Moldavan vůbec svůj
„počítač buněk“ sestrojil.
Ve svém, článku popisuje
mnoho problémů, ale
žádné výsledky.

“The purpose of the experiment is to have each microscopical cell passing through the capillary tube, register itself automatically on the photoelectric apparatus, thus creating a micro-current which can be amplified and recorded.”

Photo-Electric Technique for the Counting of Microscopical Cells

Andrew Moldavan
Montreal, Canada
Science 80:188-189, 1934

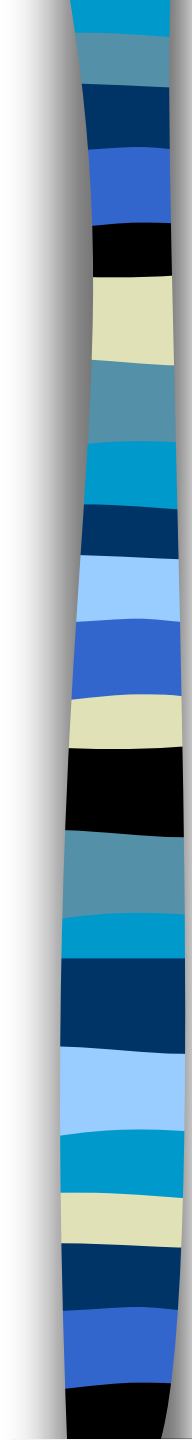

Coons et al 1941 – vyvinuli techniku fluorescenčního značení protilátek - označili anti-pneumokokové protilátky pomocí antracénu. To jim umožnilo detekovat protilátky i patogeny v tkáni pomocí UV fluorescence.

“Moreover, when Type II and III organisms were dried on different parts of the same slide, exposed to the conjugate for 30 minutes, washed in saline and distilled water, and mounted in glycerol, individual Type III organisms could be seen with the fluorescence microscope.....”

Immunological Properties of an Antibody Containing a Fluorescent Group

Albert H. Coons, Hugh J. Creech and R. Norman Jones

Department of Bacteriology and Immunology, Harvard Medical School, and the Chemical Laboratory, Harvard University
Proc. Soc. Exp.Biol.Med. 47:200-202, 1941

Coons a Kaplan (1950) - konjugovali fluorescein s isokyanátem (FITC) – získali lepší signál – dále od autofluorescence.

Friedman

Friedman (1950) – kombinoval kyselý fuchsin, akridinovou žlutá a berberin pro detekci buněk nádorů dělohy pomocí fluorescenčního mikroskopu

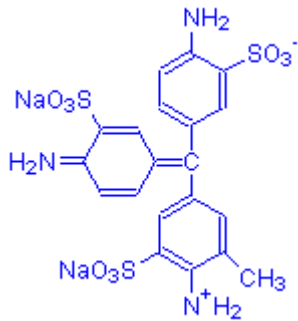

Acid Fuchsin

Acid magenta

Acid rubin

Acid roseine

Absorption Max 540-545

von Bertalanffy & Bickis

Ludwig von Bertalanffy (1901-1972)

von Bertalanffy & Bickis (1956)

- metachromatická fluorescence Akridinové oranže byla použita pro detekci RNA v tkáni
- použili ji také pro rozlišení normálních a nádorových buněk

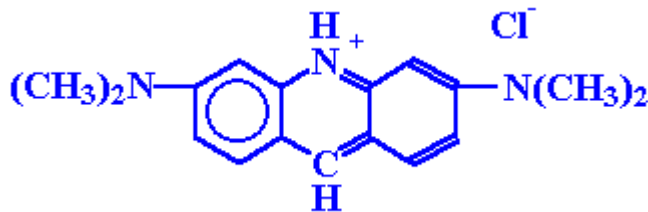

Absorption Max 467 nm

Immunodetekce

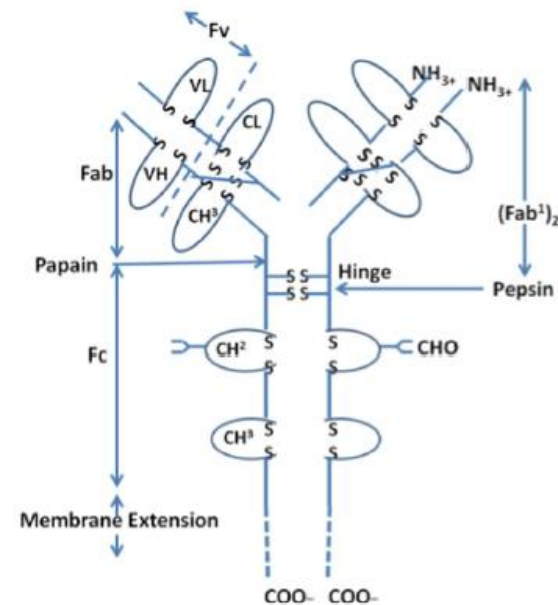
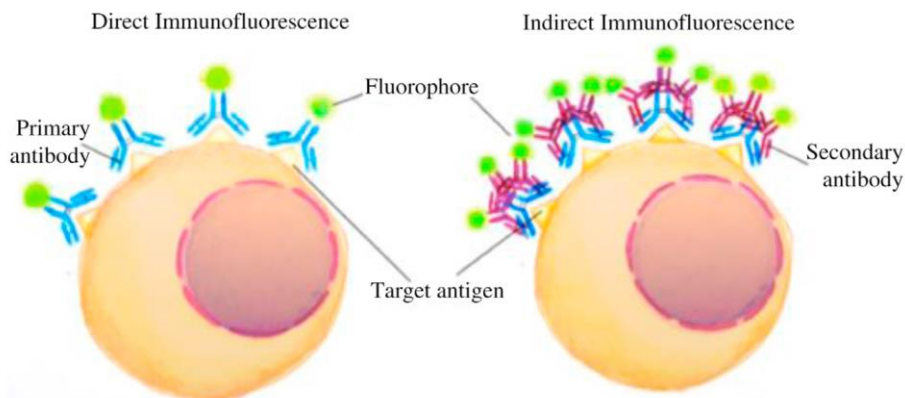

History:

1940 – Conns, imunofluorescenční značení kryožřzů

1959 – Singer, vývoj metody konjugující protilátky se značkou

1966 - Graham&Karnovsky, metoda značení protilátek enzymy (HRP)

1974 – Taylor&Burns – rutinní imunohistochemie

1975 – Kohler&Milstein – produkce monoklonálních protilátek pomocí hybridomů

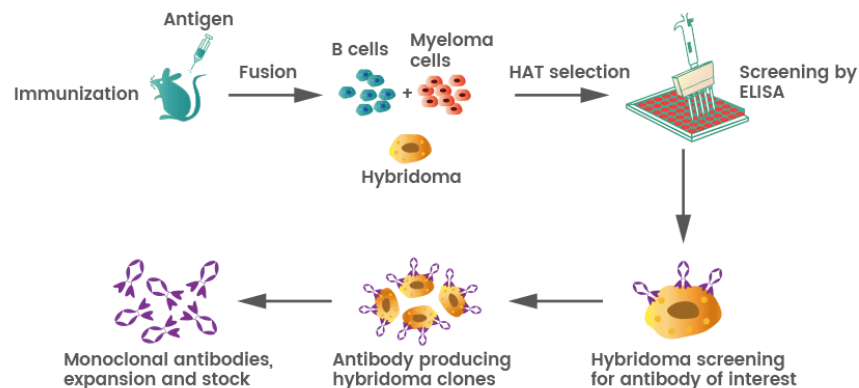



Explore



Validate



Learn

Search h

Search for

Application

Any



Search

[Advanced search](#) ▾e.g. [Her2](#), [Transcription factors](#), [Chromosome X](#)

A portal for validated antibodies

Antibodypedia scores antibodies to guide researchers to choose an appropriate antibody for a particular application. The resource contains information about more than four million publicly available research antibodies towards over 19,000 human protein targets from more than 85 providers.

Use "Search for" to find validated antibodies against your target protein for a particular application! The antibodies are scored using the [validation principles](#) outlined by the International Working Group for Antibody Validation and we encourage feedback from researcher by [submitting validation data](#) for a particular antibody.

Content updated 2021-09-09

4480670 reviewed antibodies from **95 providers**, covering gene-products encoded by **19109** genes (approximately **95%** of all human genes).

Primary data available for **2181179** experiments.

Featured Validations

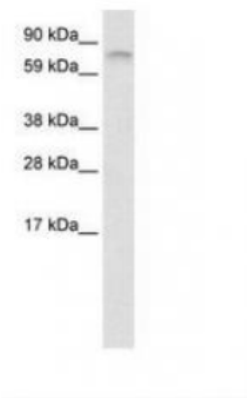
**LS-C433002**

Fetal Brain Lysate. This image was taken for the unconjugated form of this product. Other forms have not been tested.

[More info](#)

THE HUMAN PROTEIN ATLAS

≡ MENU HELP NEWS

SEARCH[!]

dsg1

Search

Fields »

e.g. ACE2, GFAP, EGFR

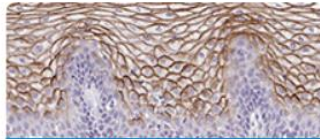

TISSUE ATLAS



SINGLE CELL TYPE ATLAS

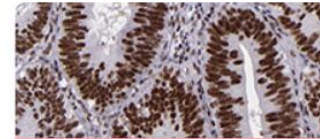

PATHOLOGY ATLAS

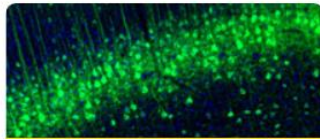

BRAIN ATLAS

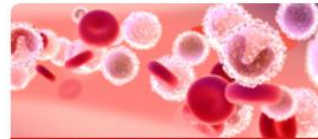

BLOOD ATLAS

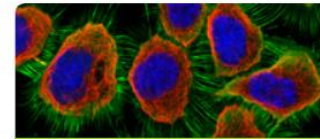

CELL ATLAS

Digital collection History of the Human Protein Atlas



Recent news

Wed, 28 Jul 2021

A single cell type map of human tissues

Thu, 22 Jul 2021

Movie of the month: The Fatty Liver

Tue, 15 Jun 2021

Movie of the month: The Spleen

[all news articles](#)

PRESS ROOM



contact@proteinatlas.org

INTRODUCTION

PUBLICATIONS

LICENCE & CITATION

DOWNLOADABLE DATA

Version: **20.1**
Atlas updated: 2021-02-24
[release history](#)

Proteome analysis based on
26941 antibodies targeting
17165 unique proteins

Stain Your Own Cell

ThermoFisher
SCIENTIFIC

[Home](#) > [Life Sciences](#) > [Lab Data Management & Analysis Software](#) > [Lab Apps](#) > [Cell Staining Tool](#)

Cell Staining Tool

Stain your own cell

Stain your own cell using our cell staining tool, for reproducible results with many of our signature fluorescent dyes. Create your perfectly labeled fluorescent cell and share it with your colleagues using the email or print function. If you have any questions, simply click the help button to send an email to our technical support group.

sher
F I C

Search All

Search by catalog number, product name, keyword, application

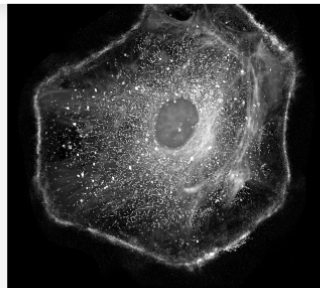

select a cell structure
to get started

1 SELECT A STRUCTURE

2 SELECT A COLOR

3 SELECT A STAIN

Autophagosomes
Cytoskeleton-Actin
Cytoskeleton-Tubulin
Cytoskeleton-Talin
Endoplasmic Reticulum
Endosomes
Golgi
Lysosomes
Mitochondria
Nucleus
Peroxisomes
Plasma Membrane

PRODUCT

LIVE FIXED

P.J. Crossland-Taylor

„Sheath Flow“ princip

“Provided there is no turbulence, the wide column of particles will then be accelerated to form a narrow column surrounded by fluid of the same refractive index which in turn is enclosed in a tube which will not interfere with observation of its axial content.”

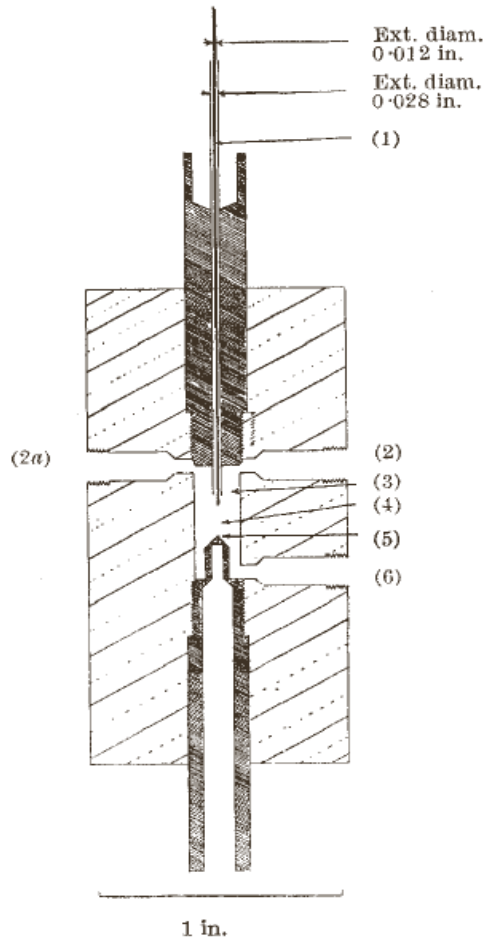

(1) Needle in holder; (2) and (2a) inflow tubes; (3) wide-bore tube; (4) observation area for (3); (5) vortex; (6) flushing tube

A Device for Counting Small Particles suspended in a Fluid through a Tube

ATTEMPTS to count small particles suspended in fluid flowing through a tube have not hitherto been very successful. With particles such as red blood cells the experimenter must choose between a wide tube which allows particles to pass two or more abreast across a particular section, or a narrow tube

P. J. CROSLAND-TAYLOR*

Bland-Sutton Institute of Pathology,
Middlesex Hospital,
London, W.1.
June 17.

No. 4340 January 3, 1953

NATURE

Wallace Coulter



- Wallace Coulter - Coulter orifice - 1956 -
- (patent 1953) – měření změny vodivosti během průchodu buněk v suspenzi malým otvorem

Originální
patentová
aplikace
W.Coultera 1953

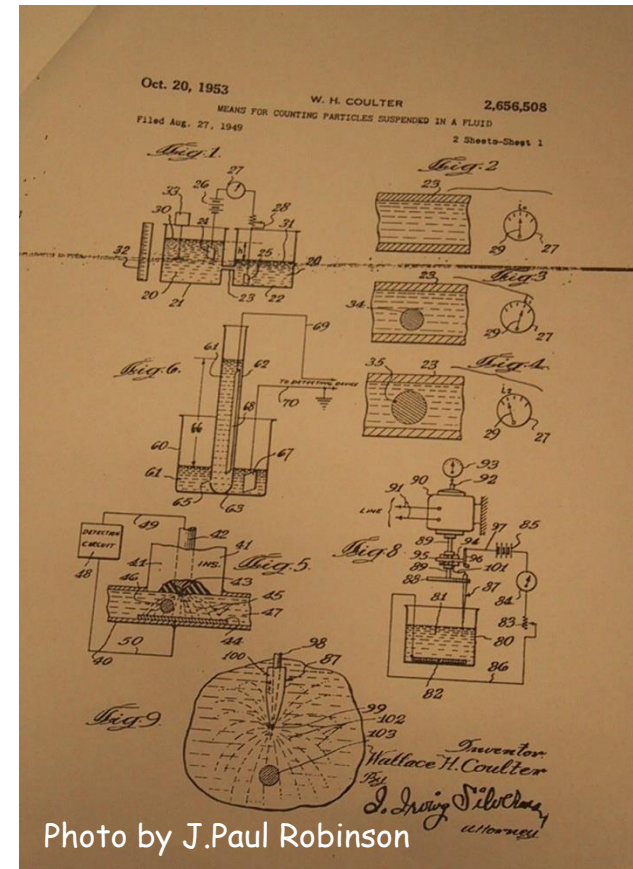
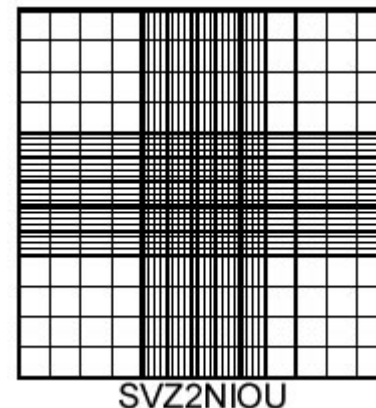
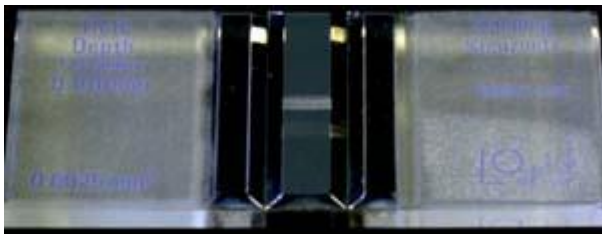

Photo by J.Paul Robinson

Jak počítat buňky?

- Hemocytometer (Bürkerova komůrka) byla standardem pro počítání buněk do ~ 1950
- Rozměry jsou 3x3x0.1 mm. Obvykle jsou červené krvinky ($1 \times 10^6/\text{mm}^3$) počítány po naředění 1:200
- Leukocyty ($5 \times 10^3/\text{mm}^3$) jsou ředěny 1:10 v roztoku lyzujícím červené krvinky
- Statistická chyba:
 - koeficient variance (CV) je při 500 spočítaných buňkách 4.4%
 - chyba pipetování a ředění je ~ 10%



Roche Innovatis Cedex



High Resolution Color Image

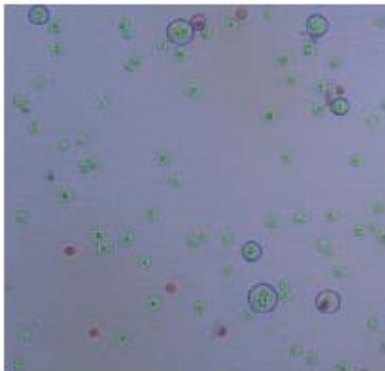

Visual Labeling



CellDrop - Denovix

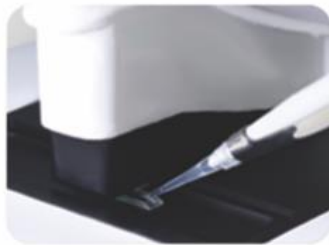

Load Cell Suspension

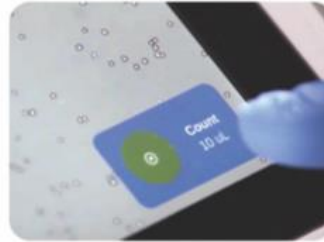

Count and Analyze

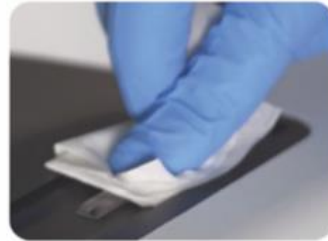

Wipe Clean - No Sample Carryover!

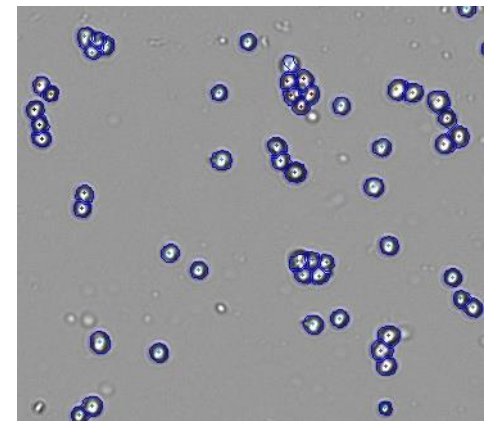
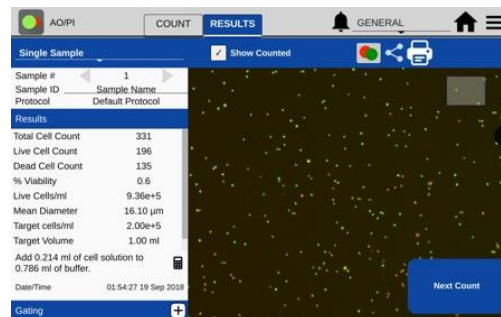
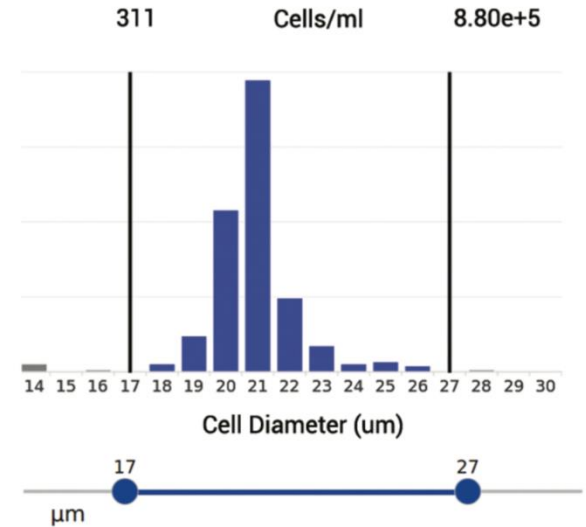

<https://www.denovix.com/celldrop/>

Coulter Counter



První komerční verze CC

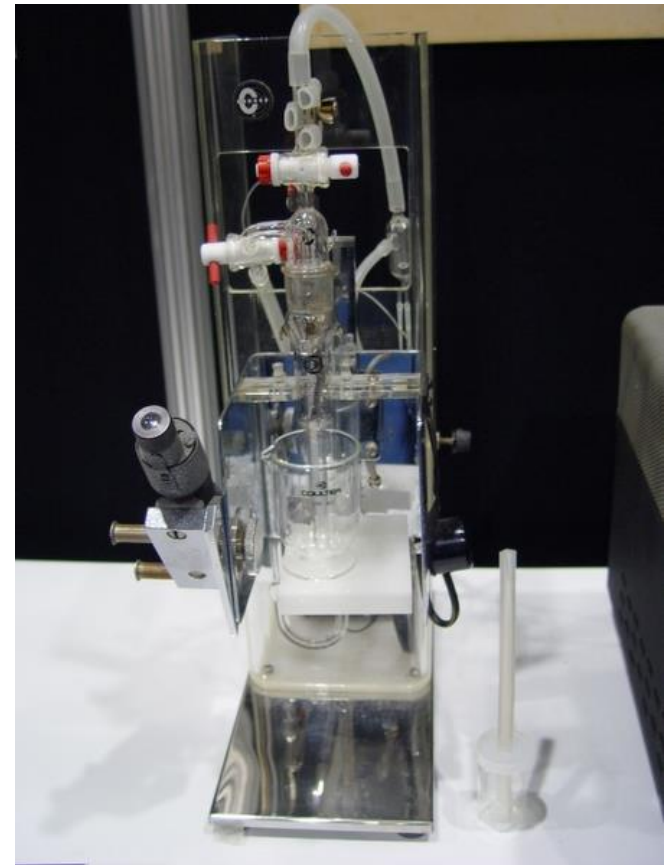

Coulter Counter

1-2

FIG. 1-1 FUNCTIONAL BLOCK DIAGRAM FOR MODEL ZF COUNTER

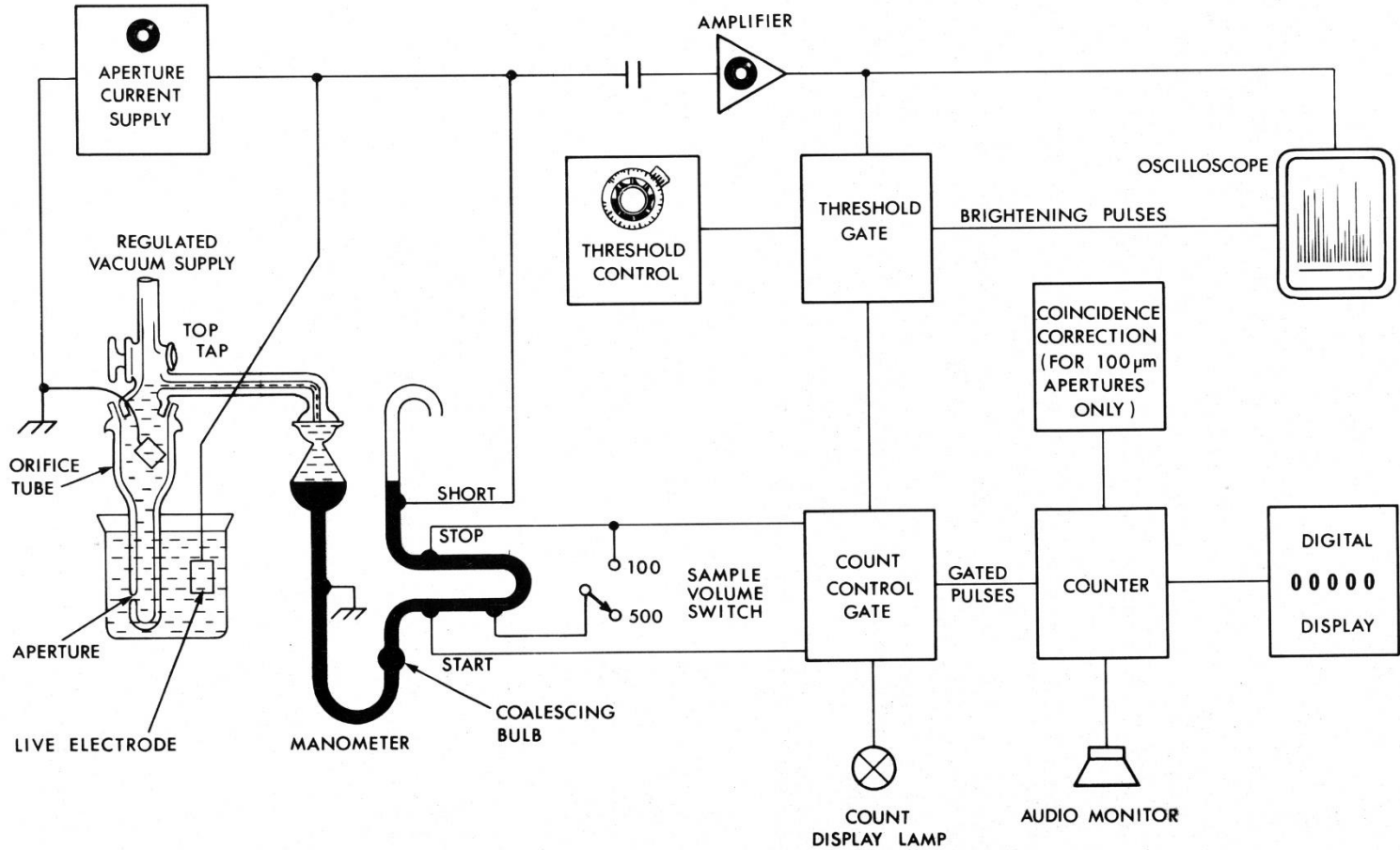

July '80

Beckman Coulter

■ Multisizer™ 3&4 COULTER COUNTER®

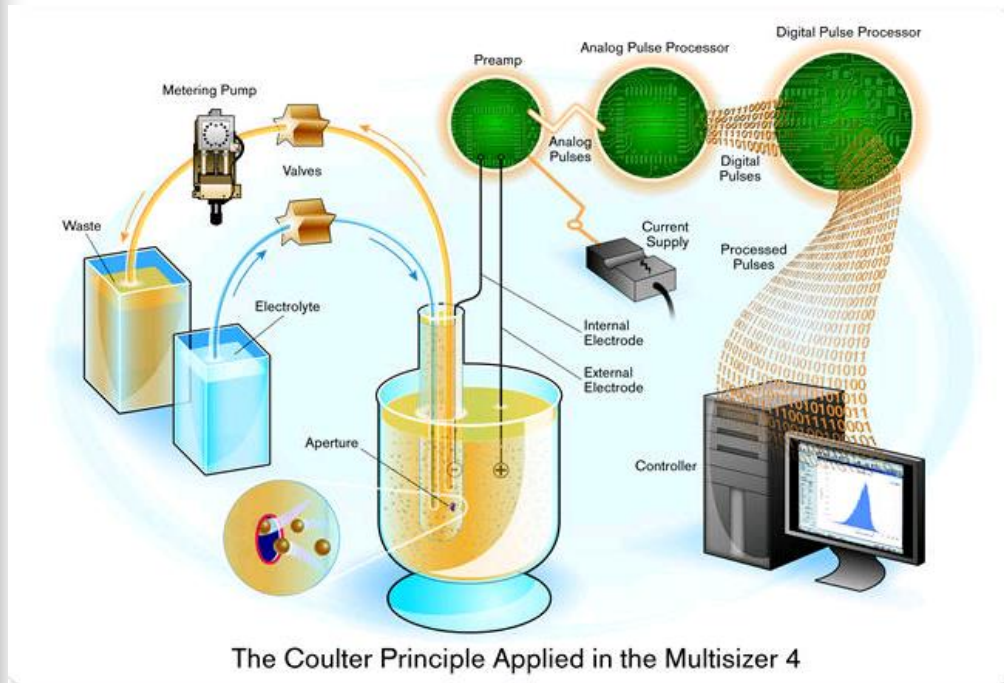

Roche Innovatis

CASY TT



Dead cells have a membrane that is permeable for the electrical current. They are measured by the size of the cell nucleus.

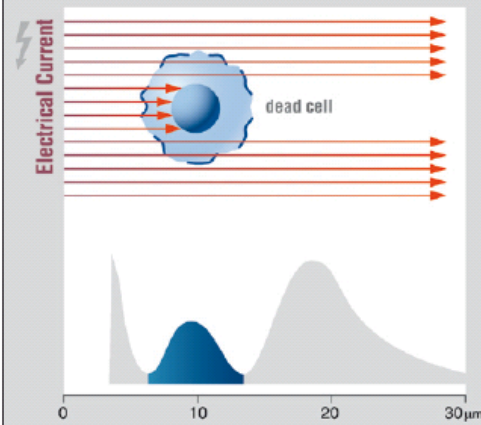

Viable cells have an intact membrane, which excludes the electrical current. They are measured by the true cell volume.

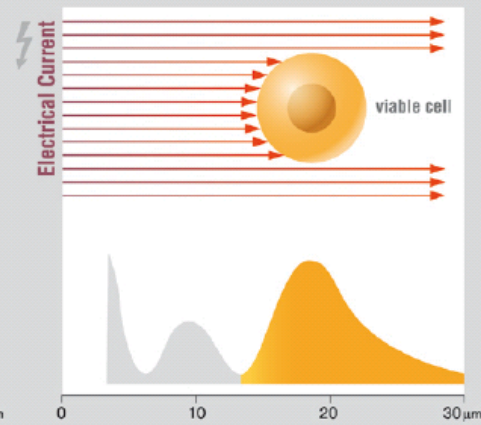

Figure 1: Viability Measurement by Electrical Current Exclusion. The status of the cell membrane distinctly affects the electrical signal generated when a cell is passing the measuring pore.



Cytograph. Stolní přístroj schopný měřit rozptyl světla **He-Ne laseru** (1970).

Mack Fulwyler- sorter

Mack Fulwyler - sorter 1965 - Los Alamos National Labs – jeho sorter separoval částice na základě elektronicky měřeného objemu (stejný princip jako Coulter counter) a separoval pomocí elektrostatického vychýlení.

Cílem bylo sortovat červené krvinky, protože u nich byla naměřena bimodální distribuce buněčného objemu. Princip separace byl založen na principu inkoustové tiskárny Richarda Sweeta ze Stanfordu (1965)

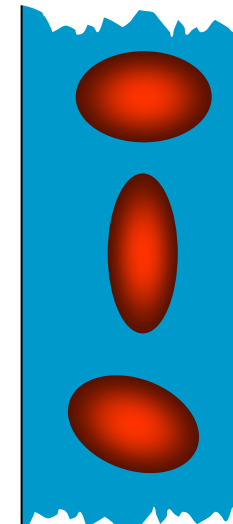
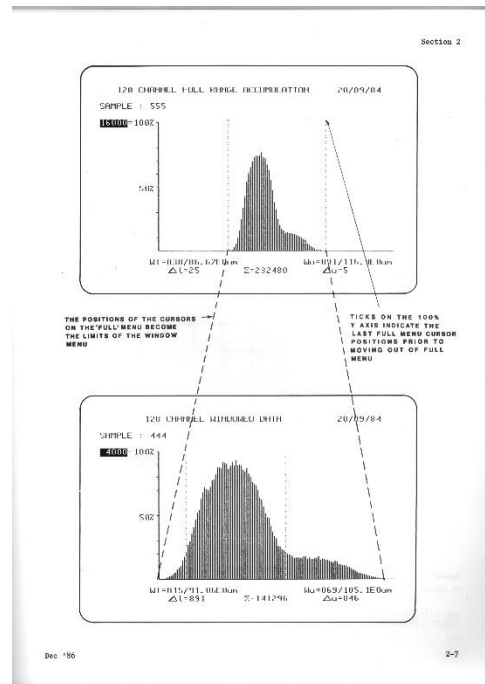

Po té co bylo objasněno, že bimodalita červených krvinek je artefakt byla tato skupina schopna separovat **neutrofilů a lymfocytů** z krve.

Richard Sweet

Richard Sweet vyvinul elektrostatickou inkoustovou tiskárnu jejíž princip využil Mack Fulwyler pro svůj buněčný sorter.

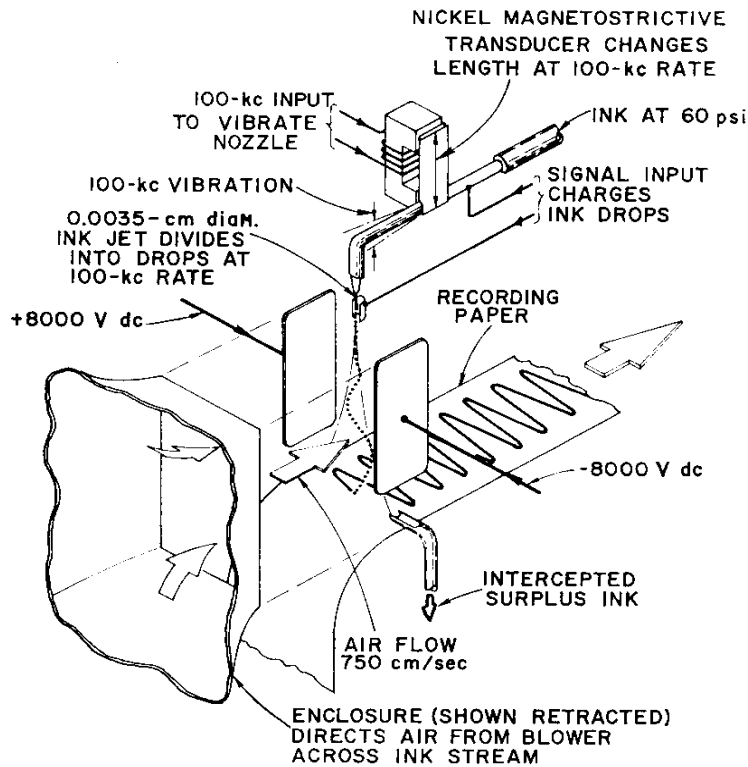

FIG. 1. Ink-jet oscillograph.

THE REVIEW OF SCIENTIFIC INSTRUMENTS

VOLUME 36, NUMBER 2

FEBRUARY 1965

High Frequency Recording with Electrostatically Deflected Ink Jets*

RICHARD G. SWEET
Systems Techniques Laboratory, Stanford Electronics Laboratories, Stanford University, Stanford, California
(Received 28 September 1964)

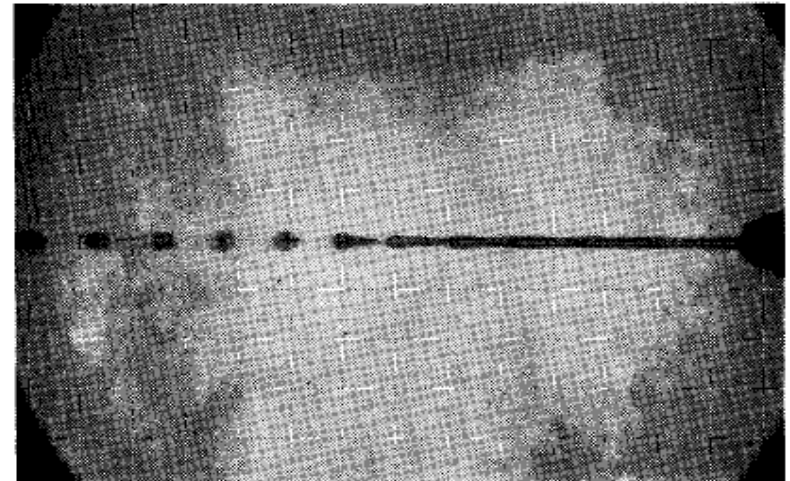
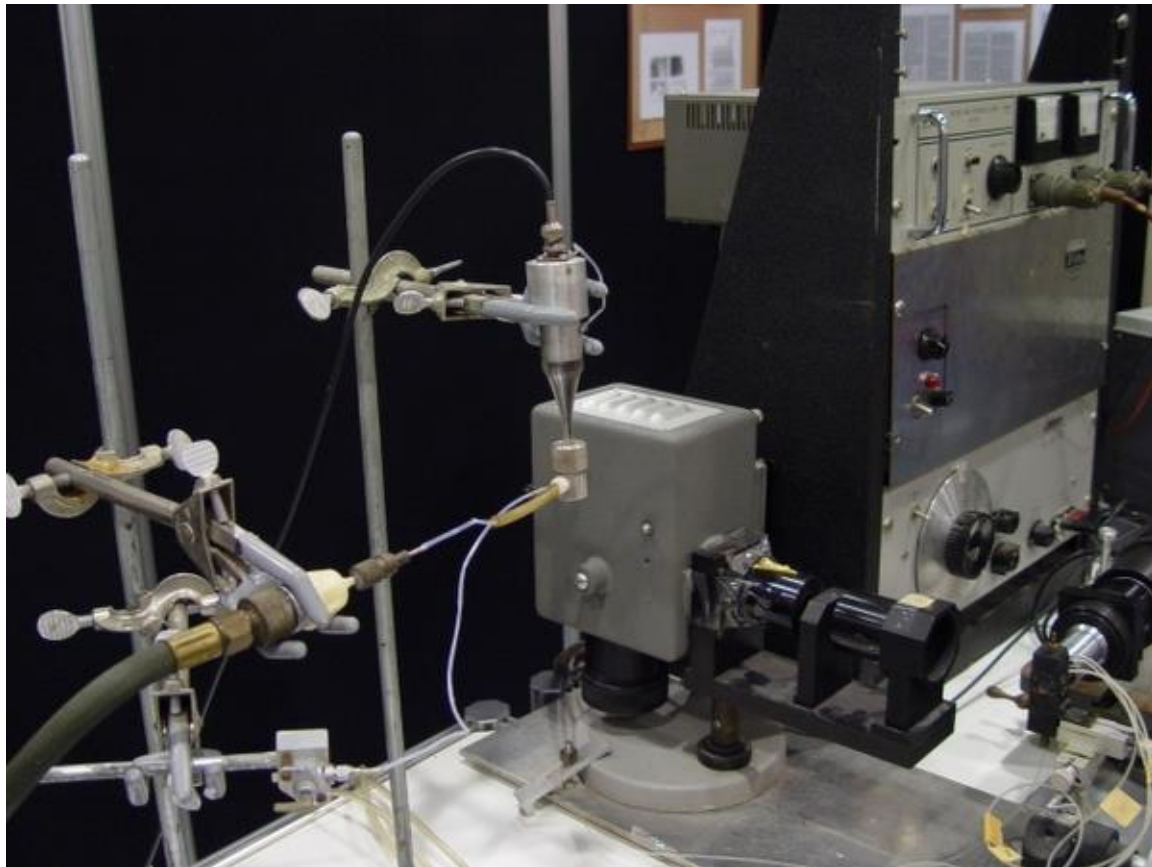
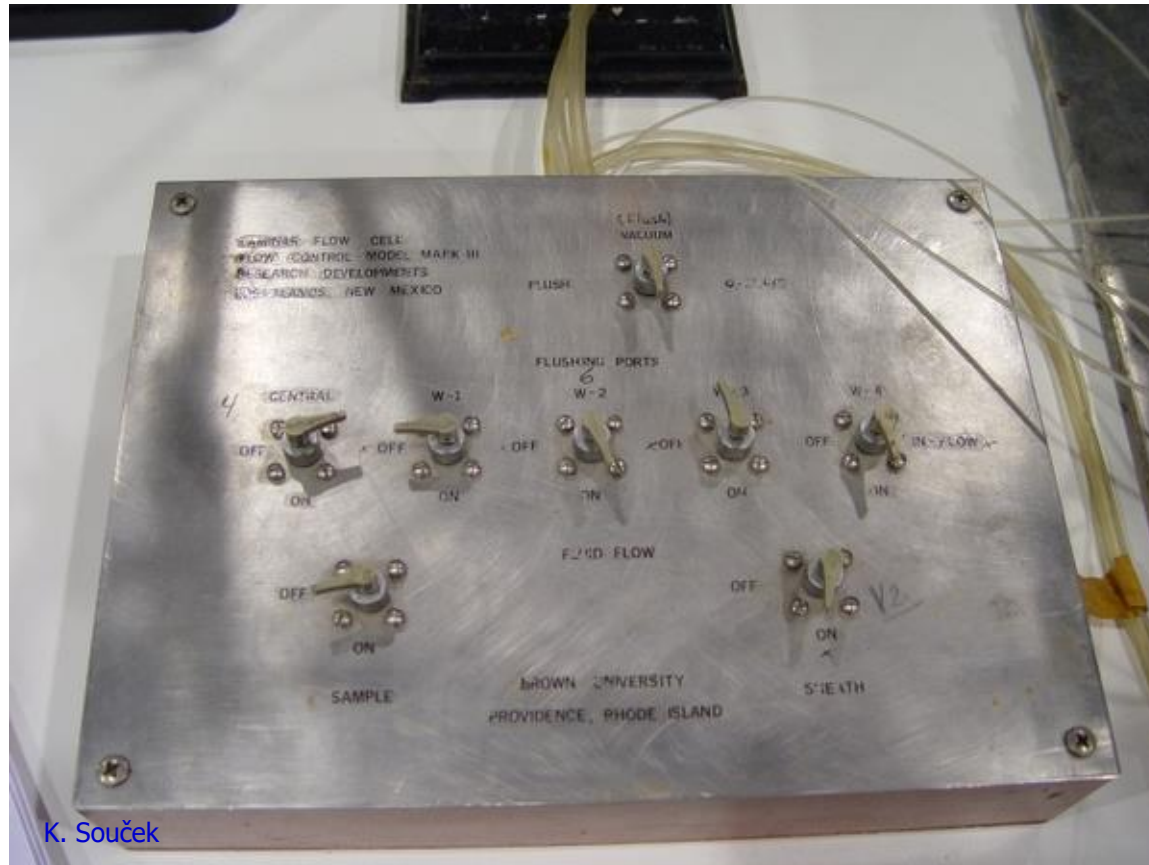

FIG. 3. Ink-drop formation.

Mack Fulwyler- sorter



Mack Fulwyler- sorter



K. Souček

Mack Fulwyler in His Own Words

J. Paul Robinson

Purdue University Cytometry Laboratories, Bindley Biosciences Center, Purdue University, West Lafayette, Indiana

Received 12 July 2005; Revision 15 July 2005; Accepted 15 July 2005

MACK FULWYLER IN HIS OWN WORDS

65

FIG. 1. The Fulwyler instrument as installed in Dr. Boris Rotman's Laboratory in Brown University, immediately prior to disassembly in March 2005. The instrument had not been altered or moved since installation in 1967, except for the addition of a laser instead of the UV lamp.



April 30, 1968

M. J. FULWYLER

3,380,584

PARTICLE SEPARATOR

Filed June 4, 1965

5 Sheets-Sheet 1

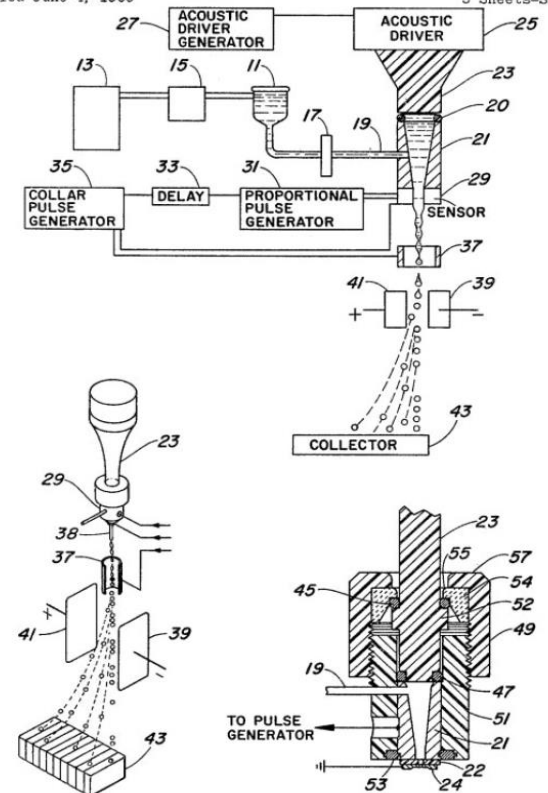

FIG. 4. A page from Fulwyler's patent on the cell separation technology patent #3,380,584 showing the fundamental components of the invention of the cell sorter.

INVENTOR.
Mack J. Fulwyler
BY
Richard A. Robinson
Attorney

Leonard Arthur "Len" Herzenberg

From Hulett, HR, Bonner, WA, Barrett, J, and Herzenberg, LA. Cell Sorting: Automated Separation of Mammalian Cells as a Function of Intracellular Fluorescence. Science 1969; 166: 747-749. Reprinted with permission from AAAS.

Cell Sorting: Automated Separation of Mammalian Cells as a Function of Intracellular Fluorescence

Abstract. A system for high-speed sorting of fluorescent cells was able to sort mouse spleen cells from Chinese hamster ovarian cells after development of fluorochromasia. Highly fluorescent fractions separated after similar treatment from mouse spleen cells immunized to sheep erythrocytes were enriched in antibody-producing cells by factors of 4 to 10.



Klíčové „cytometrické“ publikace

- 1934: Moldovan – Fotoelektrické měření buněk v kapiláře
- 1947: Gucker – fotoelektrické počítání buněk
- 1949: Coultrův počítač částic
- 1961: Rotman poprvé používá fluorescenci pro kvantifikaci enzymatické reakce
- 1964: Sweet – elektrostatická inkoustová tiskárna
- 1965: Fulwyler – květen 1965 - patent elektrostatického sorteru
- 1965: Kanetsky – spektrofotometrické měření buněk
- 1965: Fulwyler – listopad 1965 – publikace o buněčné separaci v časopise Science
- 1968: Gohde – první článek o fluorescenční průtokové cytometrii (v němčině)
- 1969: Gohde – patent
- 1969: Van Dilla – druhý článek o fluorescenční průtokové cytometrii
- 1969: Mullaney – první článek věnující se popisu rozptylu světla jako cytometrického parametru
- 1969: Heryenberg – třetí článek o fluorescenční průtokové cytometrii
- 1973: Gohde – patent dvojího značení
- 1977: Gohde – popis kompenzací signálu při dvojtém značení
- 1978: Kachel – flow imaging – kombinace průtokové cytometrie a analýzy obrazu
- 1983: izolace a detekce jader (DNA) z tkání zalitých v parafínu
- 1984: kongres o nomenklatuře cytometrie DNA
- 1987: Graz - vysokorychlostní sortování chromozómů
- 1991: Robinson – automatizace klinických systémů – průtokový cytometr a čtečka čárkových kódů

K čemu to všechno je... například...

Careers Live Careers News Sign up for newsletter Jobs Events

nature careers

Post a Job

flow cytometry

Location



Search results

We found 97 Jobs

Sort by Most Relevant ▾

Discipline

- Biomedicine 42
- Life Science 28
- Health Science 17
- Applied Science 3
- Chemistry 3
- Environmental Science 2
- Mathematics 1
- Physics 1

Job Type

- Postdoctoral 36
- Researcher 34
- Faculty Member 12
- PhD Studentship 5
- Principal Investigator 4
- Research Assistant 3
- Manager 2
- Director 1

SPOTLIGHTED JOBS



Senior Faculty Positions

The Ohio State University (OSU)
Columbus, OH, United States
3 weeks ago

Featured



Advertisement for Postdoctoral Fellow Position

OU Health Sciences Center (OUHSC)
Oklahoma City, OK, United States
3 weeks ago

Featured



Researcher (Flow cytometry Core)

St. Jude Children's Research Hospital (St. Jude)
Memphis, TN, United States
1 year ago

Featured



Postdoctoral Fellowship, Single-Cell Immunogenomics

Genmab US, Inc.
Princeton, NJ, United States
11 hours ago

Featured

K čemu to všechno je... například...

- 38 miliónů lidí na světě je infikováno virem HIV (WHO, 2019)
- ročně zemře ~ 0,7 miliónu lidí na HIV/AIDS, 1,7 milionu nově infikovaných (v Africe je ~ 11 miliónu AIDS sirotků)
- kvantifikace CD4 T lymfocytů byla/je klíčový parametr při monitorování onemocnění/léčby, od ~1985
- Since 2016, WHO recommended that all people living with HIV be provided with lifelong ART, including children, adolescents and adults, and pregnant and breastfeeding women, regardless of clinical status or CD4 cell count. By the end of 2019, 185 countries had already adopted this recommendation, covering 99% of all people living with HIV globally.
- Průtoková cytometrie je „zlatý standard“
- Optimalizované postupy a zařízení pro levné (< 3 EUR / vzorek) a rychlé detekce (250 vzorků / den)
- [Aydogan Ozcan](#): „Kill the cost, safe life“

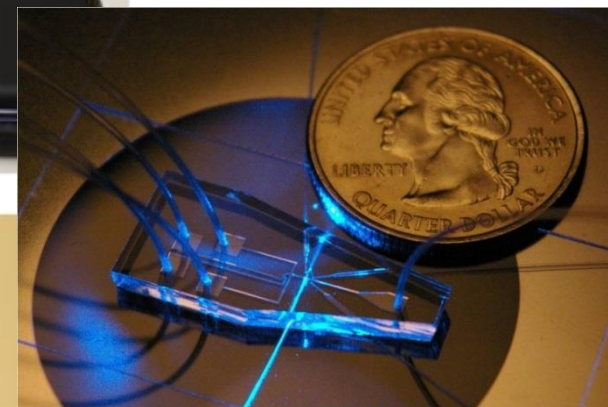
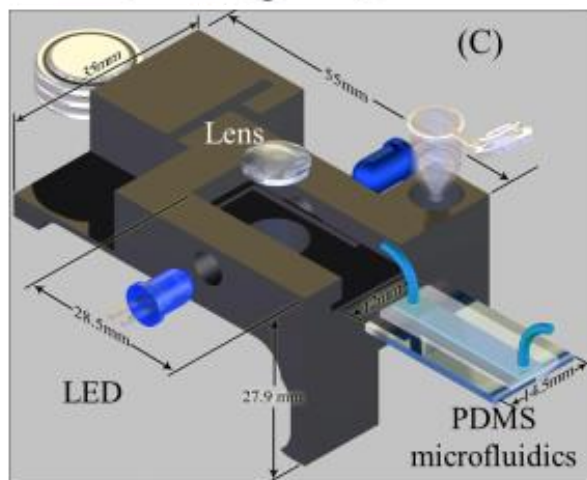
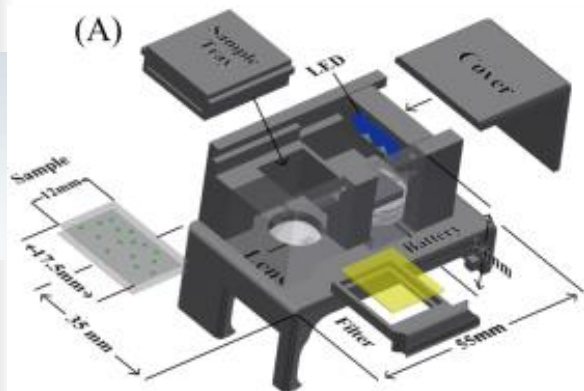

Flow Cytometry On-a-Chip

■ MAGNETIC COUNTING

- **RESEARCHER:** [Hakho Lee](#), Assistant Professor of Radiology, Harvard Medical School
PROJECT: Enumerating and characterizing circulating tumor cells
PROBLEM: Circulating tumor cells (CTCs) are incredibly rare, with just a handful per milliliter of human blood.
SOLUTION: Lee's group fabricated a hybrid microfluidic device out of polydimethylsiloxane (PDMS) that can count CTCs in real time using tiny sensors called micro-Hall detectors. ([Sci Transl Med, 4:141ra92, 2012](#))

■ PCR-ACTIVATED SORTING

- **RESEARCHER:** [Adam Abate](#), Assistant Professor of Bioengineering and Therapeutic Sciences, University of California, San Francisco
PROJECT: Analysis of rare, uncultivable microbes
PROBLEM: Developing specific antibodies for bacteria that cannot be cultured
SOLUTION: As a postdoc in the Harvard University lab of droplet-based microfluidics pioneer [David Weitz](#), Abate codeveloped a device that could sort droplets according to their fluorescence intensity. Unlike traditional microfluidics, in which molecules and cells flow naked through channels, droplet-based devices encapsulate molecules or cells in uniform, picoliter-scale aqueous reaction chambers encased in oil.

■ SORTING BY CELL DEFORMABILITY

- **PROJECT:** Cancer cell phenotyping
PROBLEM: Not every cell type has a known antigen that defines it. Plus, antibody binding may activate receptors, potentially changing the cell's behavior.
SOLUTION: A physicist by training, Guck used laser beams in his graduate work to study the physical properties of cells. Not all cells are equally squishy, he found: while normal cells are relatively rigid, cancer cells are more pliable. "The more aggressive the cell, the softer it is, and that may be necessary for it to pass into tissues," Guck explains.

■ RAMAN-ACTIVATED CELL SORTING

- **RESEARCHER:** [Jian Xu](#), Professor and Director, and Bo Ma, Group Lead of Microfluidics, Single-Cell Center, Qingdao Institute of Bioenergy and Bioprocess Technology, Chinese Academy of Sciences
PROJECT: Microbial biofuels development
PROBLEM: Biofuels R&D requires identifying cells capable of specific carbon chemistries. But as these cells have yet to be cultured and studied, researchers have few if any molecular hooks for identifying and sorting them.
SOLUTION: The team turned to a label-free method of single-cell interrogation known as Raman-activated cell sorting (RACS) ([Anal Chem, 87:2282-89, 2015](#)).

Cellular Indexing of Transcriptomes and Epitopes by Sequencing (CITE-seq)

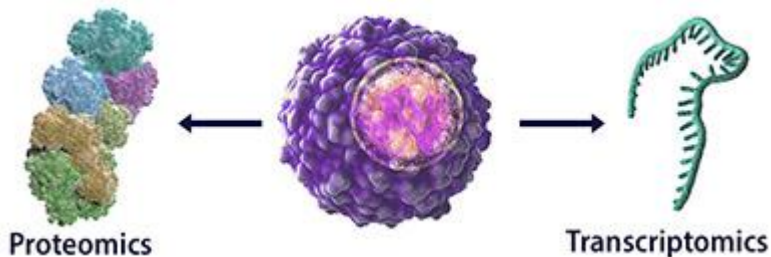
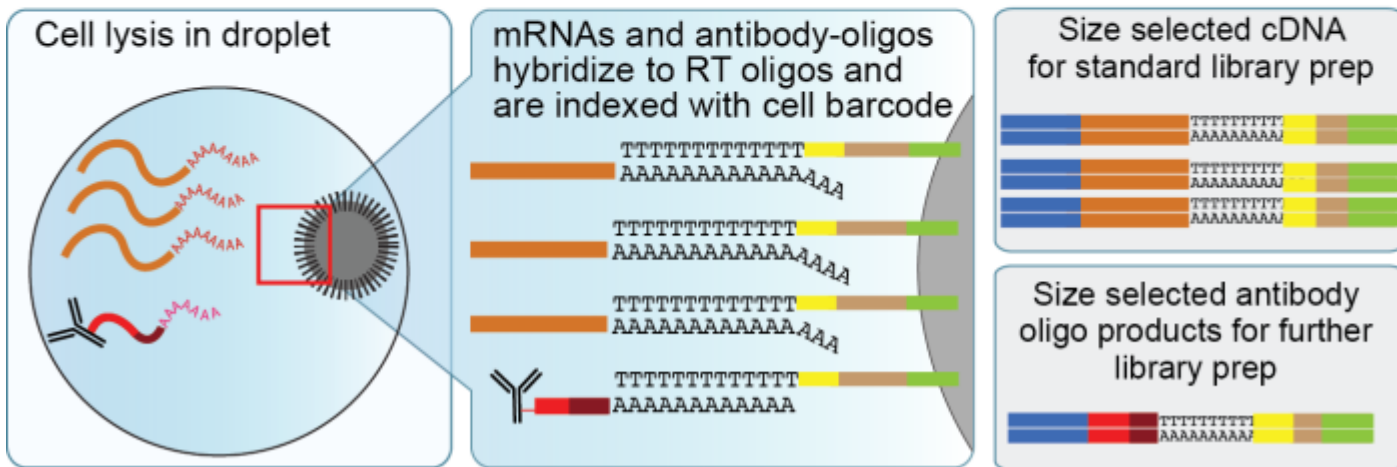
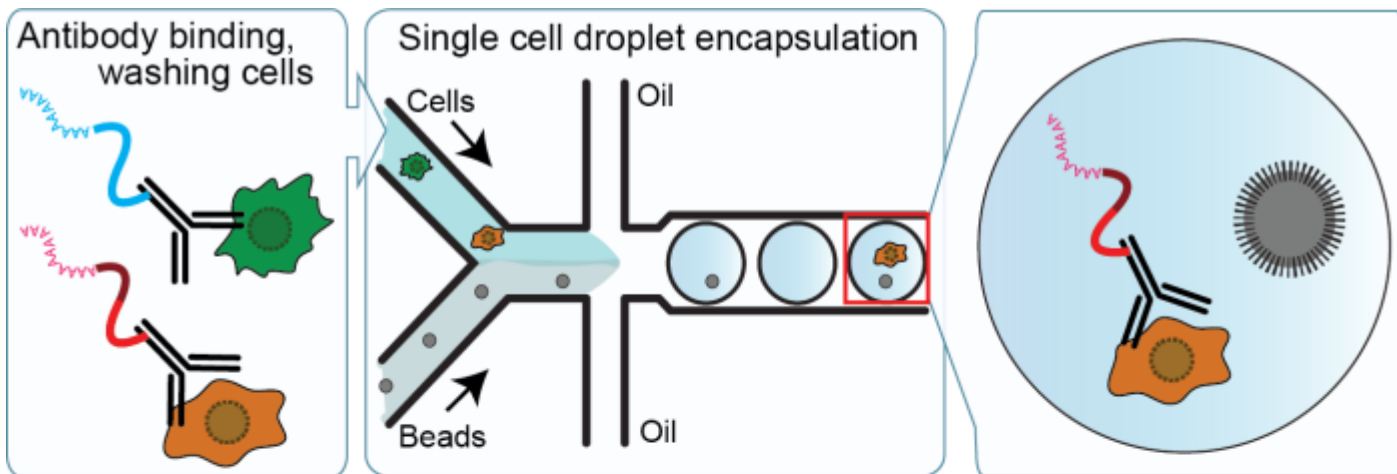



Co tomu předcházelo...a čeho jsme i nyní součástí...

- Rozvoj techniky umožňující rychlou a reprodukovatelnou detekci cytometrických parametrů.
- Nové vědecké poznatky vedoucí k definici vhodných diagnostických markerů.

ISAC presents: Mack Fulwyler - Innovator, Inventor & Pioneer

<http://www.cyto.purdue.edu/cdroms/gh/HTML/start.htm?loc=http://www.cyto.purdue.edu/cdroms/gh/HTML/video/video.html?v=Flowtheinvention.wmv>



<http://www.cyto.purdue.edu/cdroms/cyto10a/seminalcontributions/fulwyler.html>



<https://www.youtube.com/watch?v=3s512mepKkY>



State-of-the-Art



Two common ways to quantify the total number and type of cells in a sample

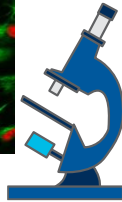
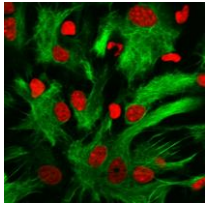

Microscopy

5
9

Provides details of cell morphology for tens or hundreds of cells. Can provide information about cellular interactions.

- + Shape
- + Distribution of components in the cell

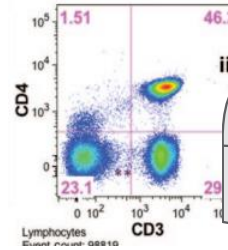

Flow Cytometry

Quantifies a high number parameters of cells in suspension for hundreds or thousands of cells per second and is capable of sorting living cells.

- + Size
- + Granularity
- + Surface and intracellular components

BD CellView™ Image Technology, provides the features of both and more



High speed, high-parameter flow cytometry



High-content images providing cell morphology and cellular interactions



Rapid analysis and sorting of cell populations defined by traditional flow parameters combined with new image parameters



January 21st, 2022

RESEARCH TECHNOLOGY

High-speed fluorescence image-enabled cell sorting

Daniel Schraivogel¹, Terra M. Kuhn^{2†}, Benedikt Rauscher^{1†}, Marta Rodríguez-Martínez^{1†}, Malte Paulsen^{3†}, Keegan Owsley⁴, Aaron Middlebrook⁴, Christian Tischer⁵, Beáta Ramasz³, Diana Ordoñez-Rueda³, Martina Dees², Sara Cuylen-Haering^{2*}, Eric Diebold^{4*}, Lars M. Steinmetz^{1,6,7*}

Fast and selective isolation of single cells with unique spatial and morphological traits remains a technical challenge. Here, we address this by establishing high-speed image-enabled cell sorting (ICS), which records multicolor fluorescence images and sorts cells based on measurements from image data at speeds up to 15,000 events per second. We show that ICS quantifies cell morphology and localization of labeled proteins and increases the resolution of cell cycle analyses by separating mitotic stages. We combine ICS with CRISPR-pooled screens to identify regulators of the nuclear factor κ B (NF- κ B) pathway, enabling the completion of genome-wide image-based screens in about 9 hours of run time. By assessing complex cellular phenotypes, ICS substantially expands the phenotypic space accessible to cell-sorting applications and pooled genetic screening.

Schraivogel *et al.*, *Science* **375**, 315–320 (2022)

BD technology and innovation

Real-time cell images

Mouse over any data point and see the cell image pop-up

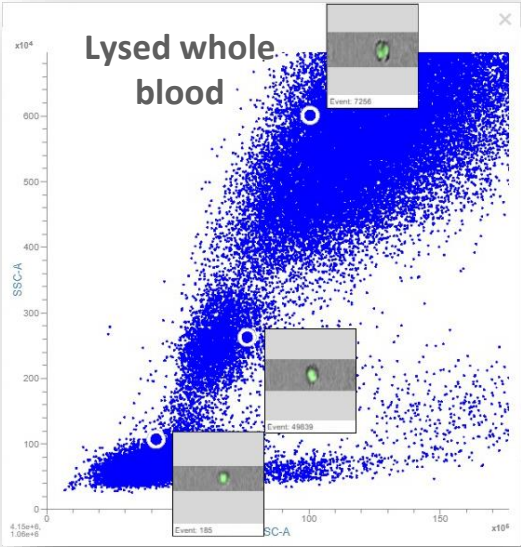

6
2

Image data and all flow data are merged and correlate one to one

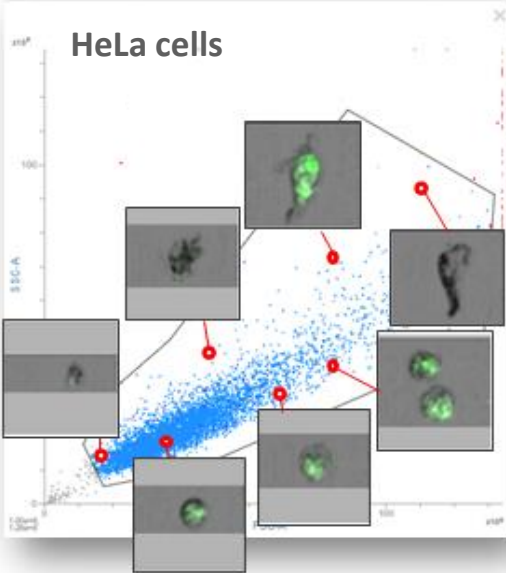

Real time display of gated events on image wall

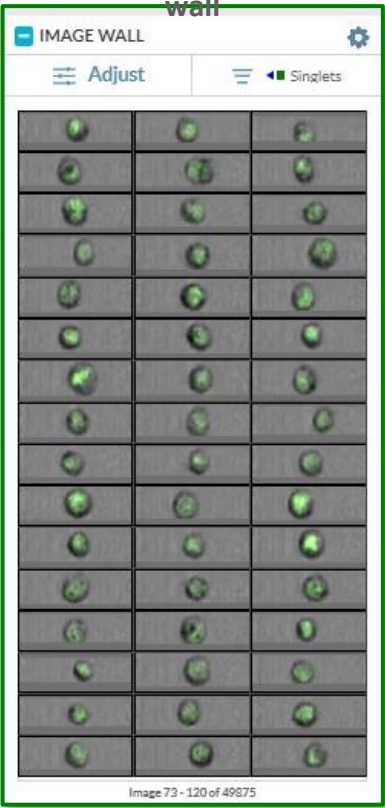

Real-time image-enabled sorting

See what you sort. Sort what you see.

The BD FACSDiscover[®] S8 Cell Sorter leverages BD CellView[™] Image Technology, a novel high-speed imaging technology that facilitates analysis and sorting through real-time integration of image and flow data.

BD CellView[™] Image Technology



IMAGING DETECTORS

Image detectors with fluorescent, scatter and light loss to visualize events in real time and at high speed

3-color fluorescence imaging

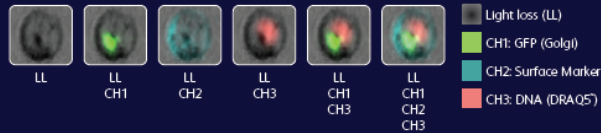

NEW INSIGHTS

New insights and image-based applications help to address previously impossible-to-answer questions



CELL MORPHOLOGY

Explore cell morphology with internal and external spatial characteristics



SAMPLE QC

Visualize and confirm images in real time to obtain sample data for flow cytometry and downstream assays



IMAGE FEATURES

Image features combined with traditional flow parameters open the door to new dimensions in single-cell analysis



ADDITIONAL IMAGE FEATURES

- Center of mass (X)
- Center of mass (Y)
- Forward scatter (FSC)
- Light loss (blue)
- Long moment
- Short moment
- Size
- Side scatter (SSC)
- Total intensity



Shrnutí přednášky

- Úvod do kurzu
- Zdroje literatury
- Historie průtokové cytometrie
- Základní principy

Na konci dnešní přednášky byste měli:

1. vědět jaké jsou požadavky pro tento kurz
2. znát základní zdroje informací
3. mít stručný přehled o historii průtokové cytometrie
4. orientovat se v některých základních principech průtokové cytometrie