

Organická chemie v archeologii, ochraně kulturního dědictví a muzeologii

Materiály

Biopolymery

Nízkomolekulární látky

Metabolity a biomarkery

Přírodní materiály

Syntetické materiály

Modifikované přírodní materiály



BIOPOLYMERY

BÍLKOVINY

NUKLEOVÉ KYSELINY

POLYSACHARIDY

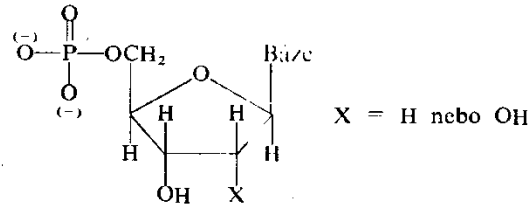
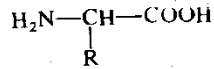
stavební jednotky

L- α -aminokyseliny

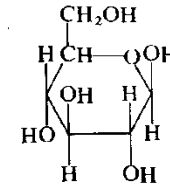
nukleotidy

monosacharidy a deriváty

struktura



např.



počet různých

20 (různé R)

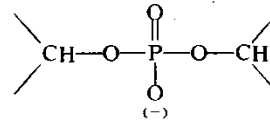
X = H nebo OH

4 (různé báze)

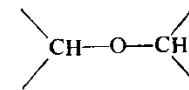
charakteristická vazba

peptidová (amidová)

fosfodiesterová C₃-C₅



glykosidová (1 \rightarrow 4, 1 \rightarrow 6)

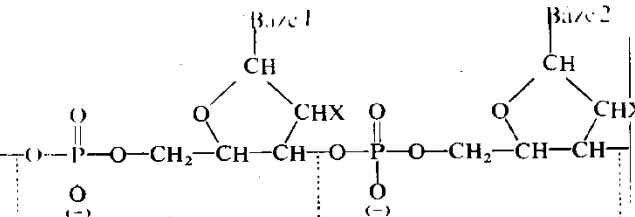
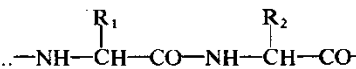


řetězec

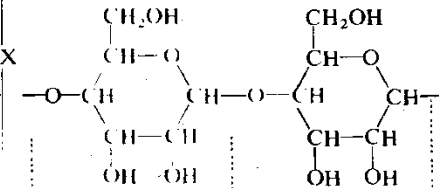
polypeptidový

polynukleotidový

polysacharidový



např.



lineární

lineární

lineární nebo větvený
(např. vazbami 1 \rightarrow 6)

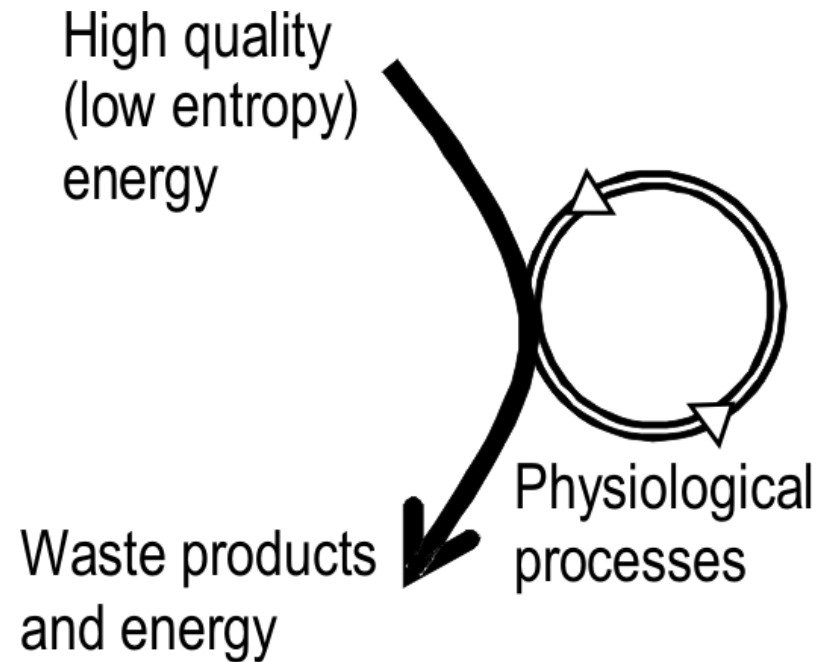
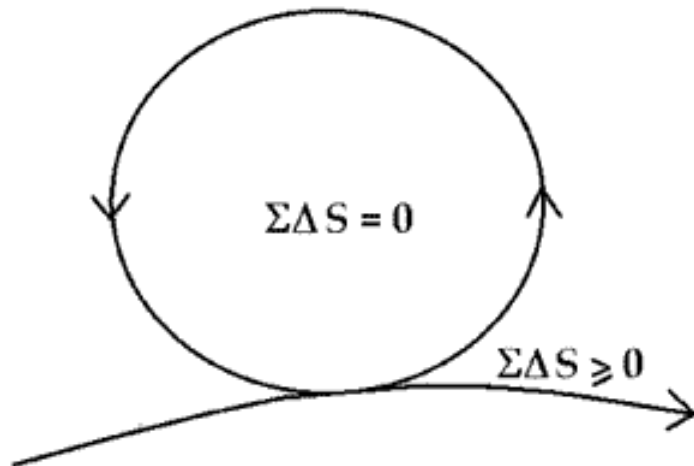
pestrost je dána

různým pořadím stavebních jednotek

různými typy glykosidových vazeb,
větvením, substitucemi sacharidových
kruhu

Metabolismus živých organismů

- Stacionární stav
- Dynamická rovnováha



Postmortální změny

Biostratinomie

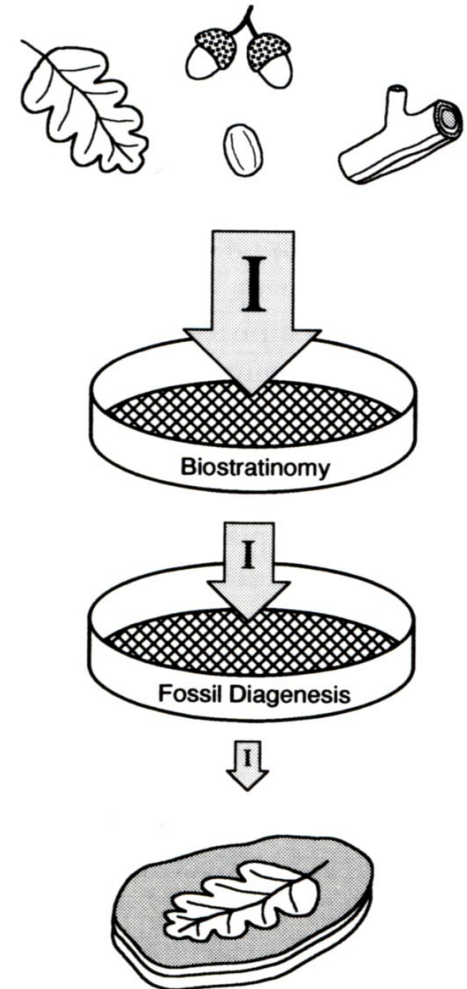
= období mezi smrtí organismu a depozicí v sedimentu.

Tafonomie

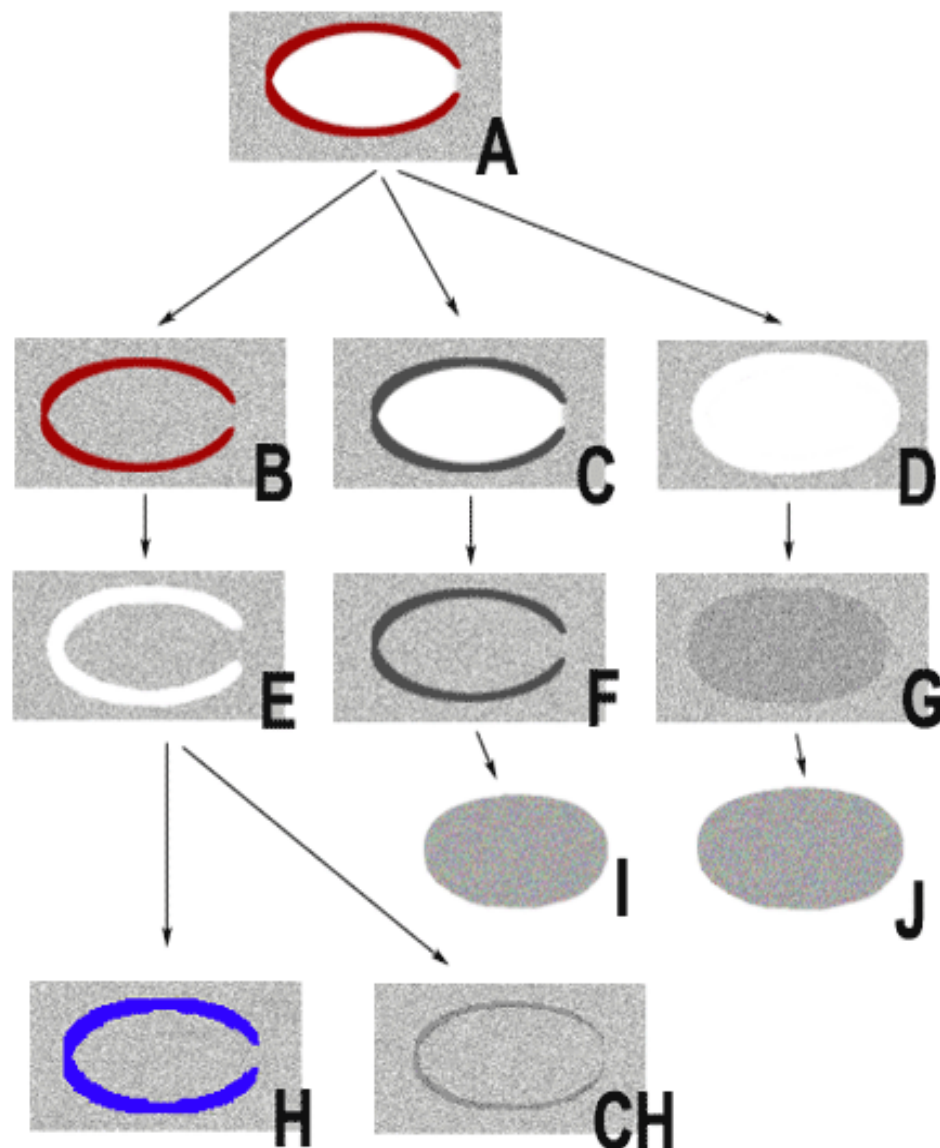
= období mezi depozicí v sedimentu a exkavací, resp. období mezi smrtí organismu a exkavací.

Diageneze

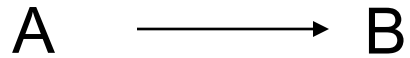
= soubor procesů probíhajících po uložení sedimentu (mechanické a chemické)



- A – schránka v sedimentu
- B – dutina schránky vyplněná okolním sedimentem
- C – původní hmota schránky je nahrazena druhotnou fosilizační hmotou
- D – schránka vyloužena, dutina schránky druhotně nezaplněna (otisk)
- E – původní hmota schránky vyloužena (volné jádro)
- F – dutina schránky vyplněna nerostem nebo horninou jádro
- G – prázdný prostor druhotně vyplněn nerostem (odlitek s proti-otiskem)
- H – dutina po vyloužení schránce druhotně vyplněna nerostem (výlitek)
- CH – okolní sediment přitlačen na neztvrdlé jádro (skulpturní jádro)
- I - volné jádro s výlitkem
- J - volný odlitek



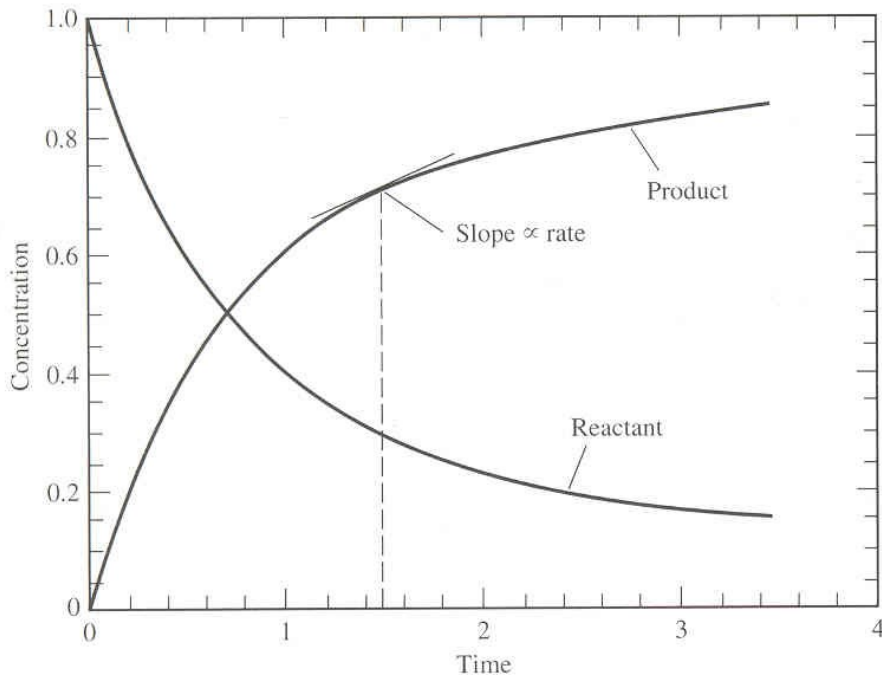
Kinetika rozkladu



$$-da/dt = k.(a-x)$$

$$\ln(a/(a-x)) = k.t$$

Nejvhodnějším matematickým modelem je exponenciální křivka.



Radioaktivní rozpad

$$dn/dt = -k.n$$

$$k = \text{konst.}$$

Reakce s kinetikou 1. řádu

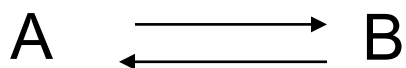
$$dn/dt = -k.n$$

$$k = f(T)$$

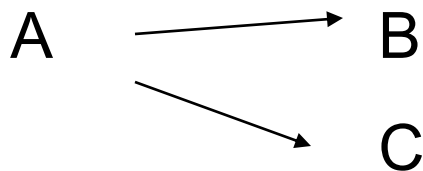
Chemická kinetika

studuje rychlost chemických reakcí

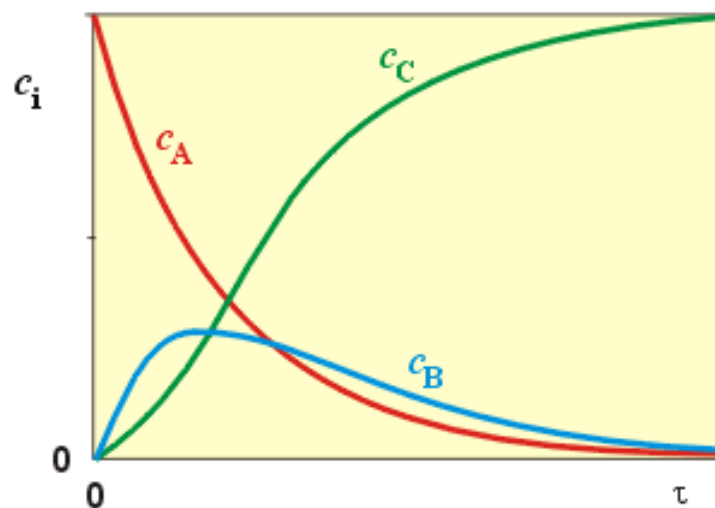
vratná



bočná



následná



Závislost rychlostní konstanty na teplotě

Arrheniova rovnice: $k = A \exp(-EA/RT)$

A je tzv. frekvenční faktor, R plynová konstanta, T termodynamická (absolutní) teplota, EA tzv. Arrheniova aktivační energie (je charakteristická pro každou reakci, pro malé rozmezí teplot je na teplotě nezávislá).

Z rovnice vyplývá, že se stoupající teplotou se zmenšuje hodnota výrazu EA/RT a tudíž roste hodnota rychlostní konstanty. Hodnota EA se určí ze zlogaritmované rovnice

$$\log k = - (EA/(2,303R))1/T + \log A$$

Hodnoty logaritmů rychlostní konstanty k se vynášejí proti hodnotám $1/T$, hodnota EA se vypočítá ze směrnice získané přímky.

Z diferenciálního tvaru Arrheniovy rovnice

$$d \ln k / dT = EA/RT^2$$

Ize získat vztah mezi rychlostními konstantami reakce při dvou různých teplotách:

$$\log(k_2/k_1) = EA(T_2-T_1)/2,303RT_1T_2$$

Analytické metody



Účel diagnostiky organických materiálů

- Identifikace a specifikace materiálu
- Charakterizace stavu degradace a datování

= obojí je důležité pro volbu konzervačního zásahu

Metody studia organických materiálů

Metody fyzikální

Metody chemické

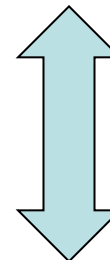
Metody biochemické

Kvalitativní

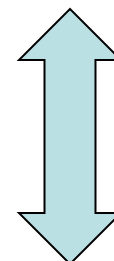
Semikvantitativní

Kvantitativní

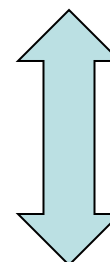
Makroskopická



Mikroskopická



Molekulární



Submolekulární

Faktory ovlivňující složení materiálu

- Metabolismus (typ tkáně, věk, druh organismu)
- Příprava materiálu (technologie)
- Aplikace materiálu
- Degradace materiálu (archeologizace, diagenese)
- Stabilizace a konzervace materiálu

Interpretace výsledků (degradační procesy)

Induktivní přístup: vytváření obecného závěru na základě pozorování (srov. „statistická indukce“)

Deduktivní přístup: interpretace výsledků pomocí již známého modelu.

K. R. Popper: deduktivní přístup je jediný správný!!!
verifikace vs. falzifikace

Všechny matematické modely jsou nesprávné,
ale některé z nich jsou užitečné.

(G. E. P. Box)

A některé velmi nebezpečné ...

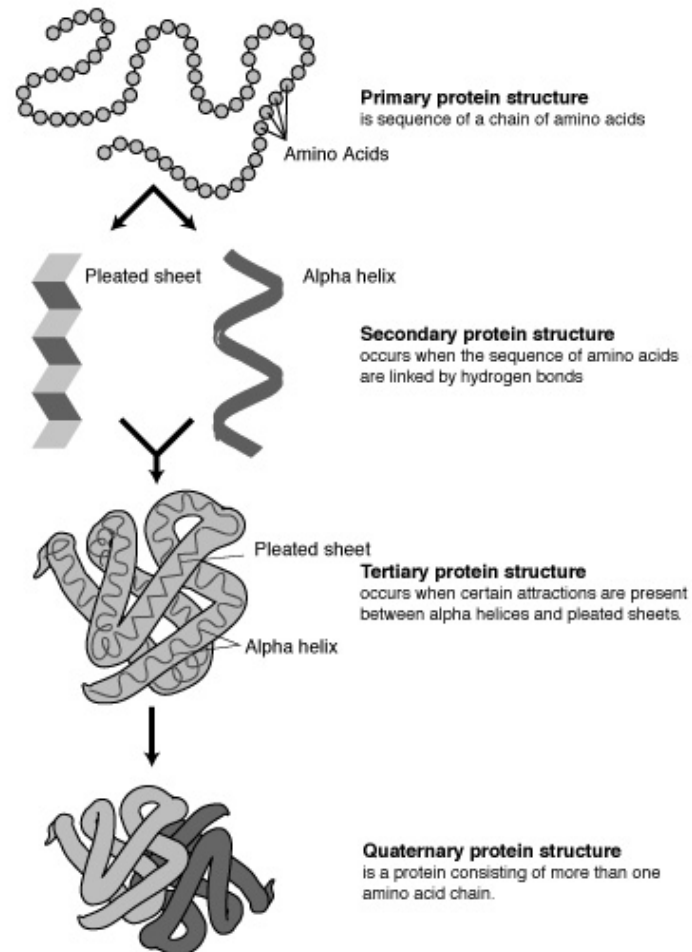
(N. N. Taleb)

Proteiny

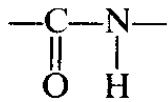
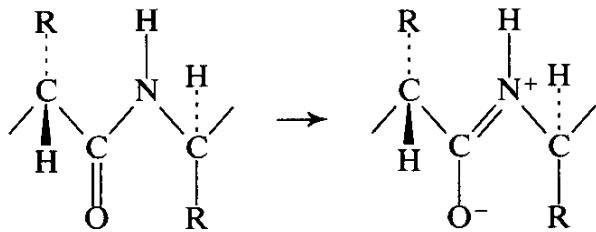
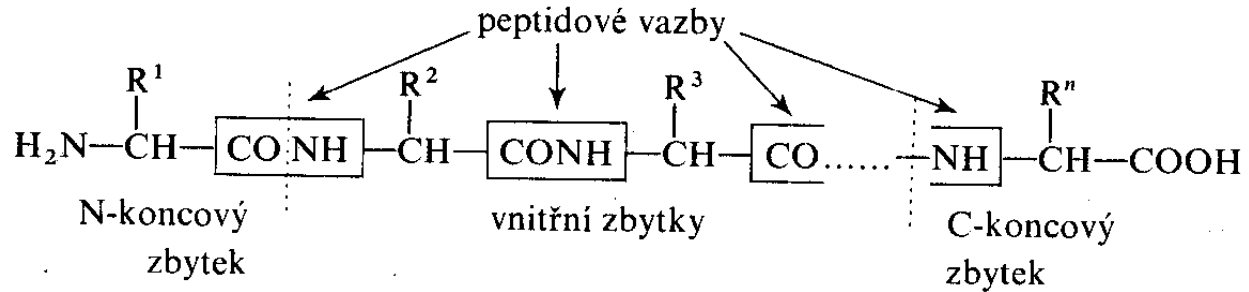
I.

Struktura proteinů

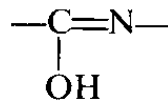
- Primární
- Sekundární
- Terciární
- Kvartérní



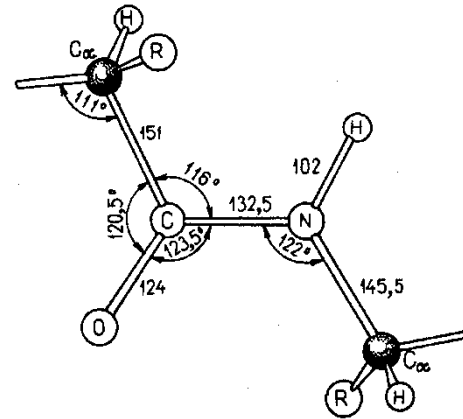
Peptidová vazba



laktam (60%)



laktim (40%)

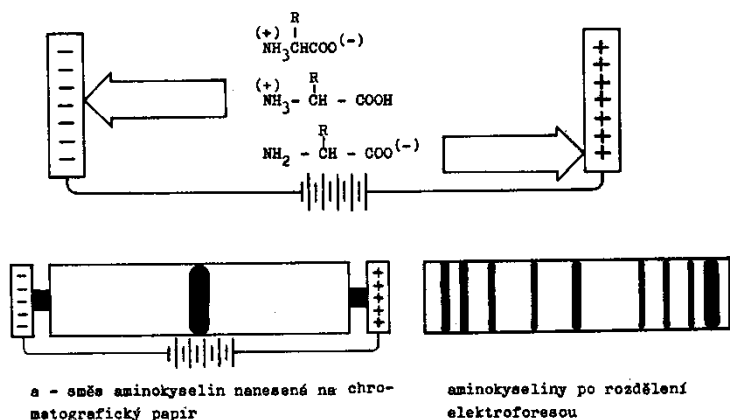


Obr. 8 Základní délky (v pm) a úhly v peptidické vazbě

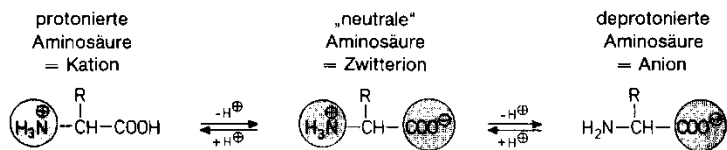
Aminokyselinové složení proteinů

	Glycin	Gly	G		Arginin	Arg
	Alanin	Ala	A		Histidin	His
	Valin	Val	V		Cystein	Cys
	Leucin	Leu	L		Methionin	Met
	Isoleucin	Ile	I		Prolin	Pro
	Serin	Ser	S		Phenylalanin	Phe
	Threonin	Thr	T		Tyrosin	Tyr
	Asparaginsäure	Asp	D		Tryptophan	Try
	Asparagin	Asn	N		Lysin	Lys
	Glutaminsäure	Glu	E			
	Glutamin	Gln	Q			

Izoelektrický bod



Obr. 20.2 Dělení aminokyselin elektroforesou



Disociační konstanty některých aminokyselin

Tabulka 1

Aminokyselina	pK ₁	pK ₂	pK ₃
Glycin	2,34	9,60	
	-COOH	-NH ₃ ⁺	
Cystein	1,96	8,18	10,28
	-COOH	-NH ₃ ⁺	-SH
Kyselina asparagová	1,88	3,65	9,60
	-COOH(α)	-COOH(β)	-NH ₃ ⁺
Lysin	2,18	8,95	10,53
	-COOH	-NH ₃ ⁺ (α)	-NH ₃ ⁺ (ε)
Fenylalanin	1,83	9,13	
	-COOH	-NH ₃ ⁺	
Histidin	1,77	6,10	8,17
	-COOH	imidazoi	-NH ₃ ⁺

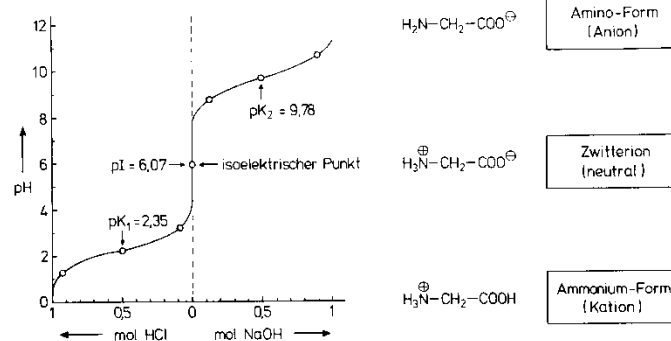
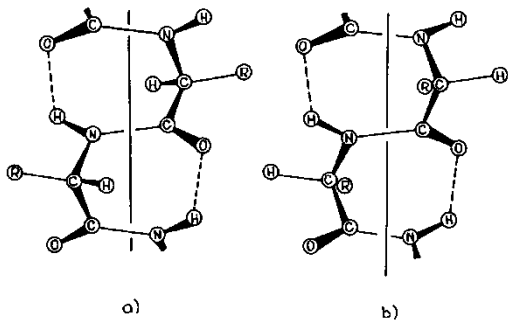


Abb. 11.2 Titrationskurve der α-Aminosäure Glycin. (Als Zeichenhilfe wurden auch die pK ± 1-Werte bei 0,1 und 0,9 mol Lauge oder Säure eingezeichnet)

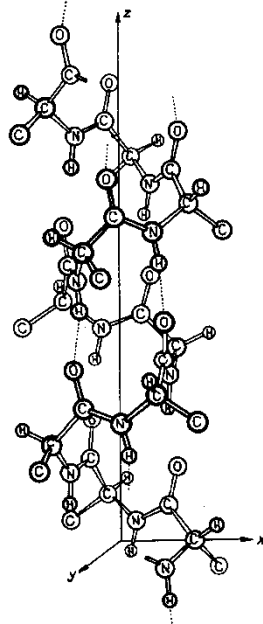
V oblasti izoelektrického bodu je protein nejstabilnější.

Sekundární struktura proteinů

Šroubovice

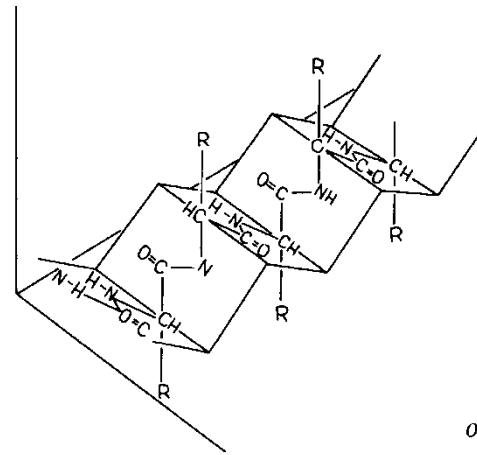


Obr. 3/5. Dvě formy kruhových systémů vodíkových vazeb v helixu polypeptidického řetězce
a – levotočivý; b – pravotočivý



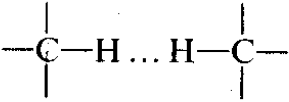
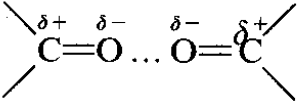
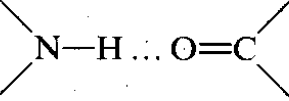
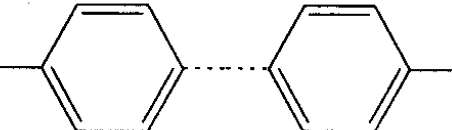
Obr. 3/6. Šroubovicová konformace α -helixu ▶

Skládaný list



Obr. 3/7. β -konformace polypeptidického řetězce

Tabulka 2-1. Typy nekovalentních interakcí uplatňujících se při formování a stabilizaci molekul bílkovin

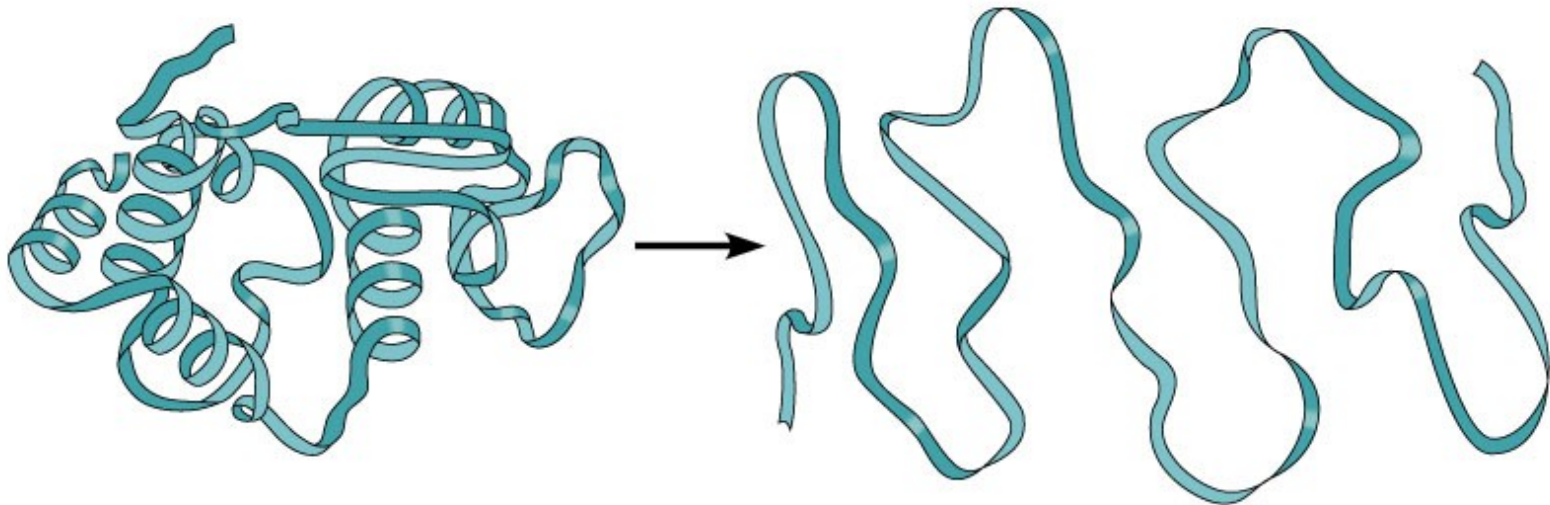
Typ interakce	Příklad	Vazebná energie kJ mol ⁻¹
disperzní síly	alifatické atomy C 	0,1
elektrostatické interakce ¹⁾	mezi ionty -COO ⁽⁻⁾ ⁽⁺⁾ NH ₃ -	21
	mezi dipóly 	1,2
vodíkové vazby	led -O-H...O	17
	polypeptidová páteř 	12
hydrofobní interakce	postranní řetězce fenylalaninu 	10 ²⁾

¹⁾ Při výpočtu elektrostatické energie byla užita pro relativní permitivitu hodnota 4.

²⁾ Změna volné energie transferu voda → ethanol.

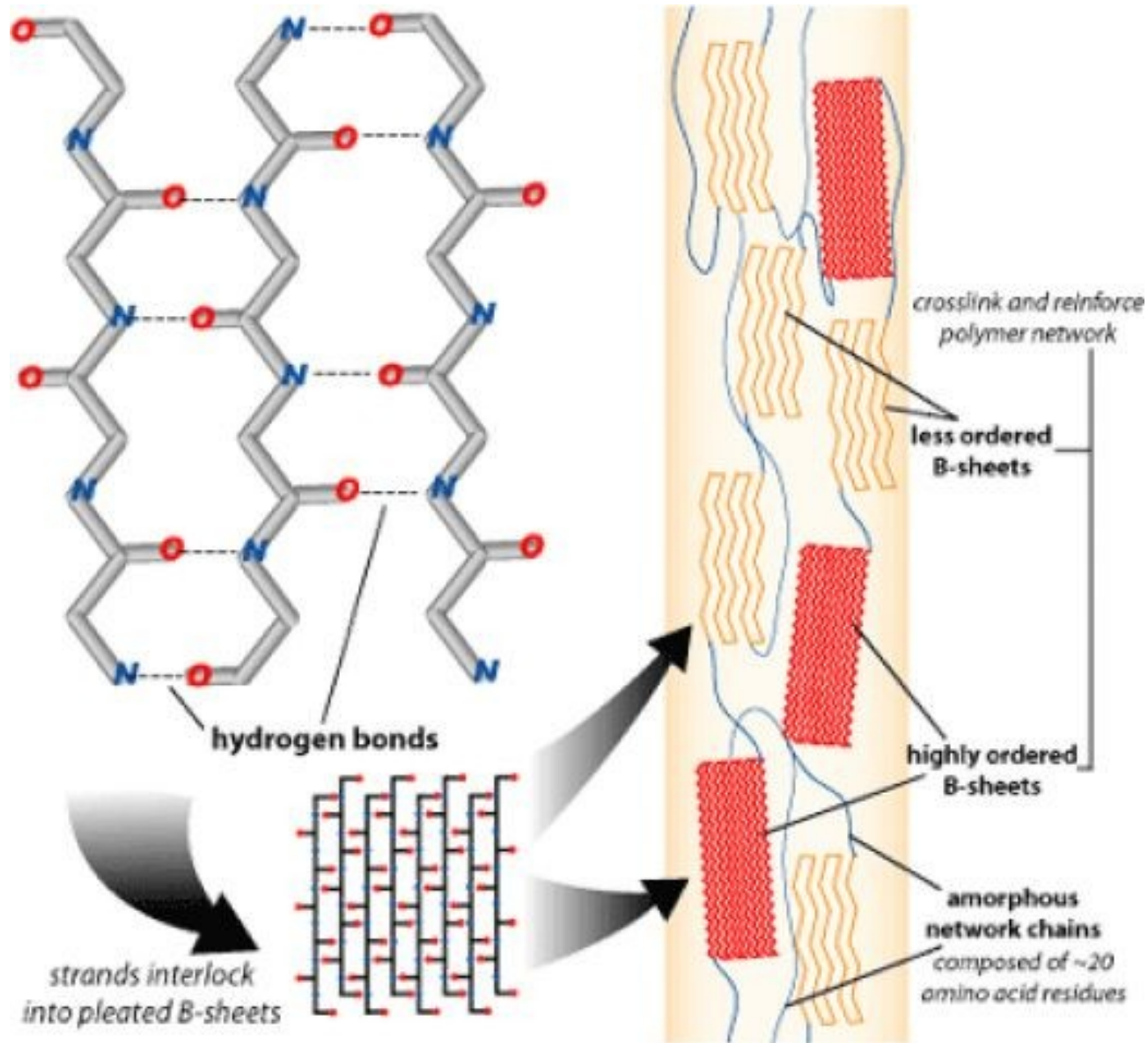
Denaturace proteinů

Nadmolekulární strukturu proteinů lze narušit fyzikálními (teplo, UV, RTG, mechanicky) a chemickými (kyseliny, zásady, org. rozpouštědla, detergenty, soli těžkých kovů, močovina, aj.) vlivy = denaturace: jsou narušovány vodíkové můstky, uvolněná struktura je přístupnější dalším atakům.



Active (functional) protein

Denatured protein



Klasifikace proteinů

- Globulární
 - Kasein
 - Albumin
 - Glykoproteiny krevních skupin
 - Vaječné proteiny
 - Myoglobin
 - Hemoglobin

- Fibrilární
 - Kolagen
 - Elastin
 - Keratin
 - Fibroin a sericin
 - Nekolagenní proteiny kosti

Table 7.2 Amino acid compositions of some structural proteins

<i>Amino acid</i>	<i>Collagen</i>	<i>Keratin (wool)</i>	<i>Keratin (feather)</i>	<i>Fibroin (silk)</i>
Glycine	26.6	6.0	7.2	42.8
Alanine	10.3	3.9	5.4	33.5
Valine	2.5	5.5	8.8	3.3
Leucine	3.7	7.9	8.0	0.9
Isoleucine	1.9	3.8	6.0	1.1
Proline	14.4	6.7	10.0	0.5
Phenylalanine	2.3	3.7	5.3	1.3
Tyrosine	1.0	5.2	2.2	11.9
Tryptophan	0.0	1.9	0.7	0.9
Serine	4.3	8.4	14.0	16.3
Threonine	2.3	6.6	4.8	1.4
Cystine	0.0	12.8	8.2	0.0
Methionine	0.9	0.6	0.5	0.0
Arginine	8.2	9.9	7.5	1.0
Histidine	0.7	3.0	0.7	0.4
Lysine	4.0	0.9	1.7	0.6
Aspartic acid	6.9	6.9	7.5	2.2
Glutamic acid	11.2	14.5	9.7	1.9
Ammonia	0.6	0.0	0.0	0.0
Hydroxyproline	12.8	0.0	0.0	0.0
Hydroxylysine	1.2	0.2	0.0	0.0

Results are taken from Ward and Lundgren¹¹, Boews *et al.*³¹ and Lucas *et al.*³² and converted to weight per cent of total.

Mléčné proteiny

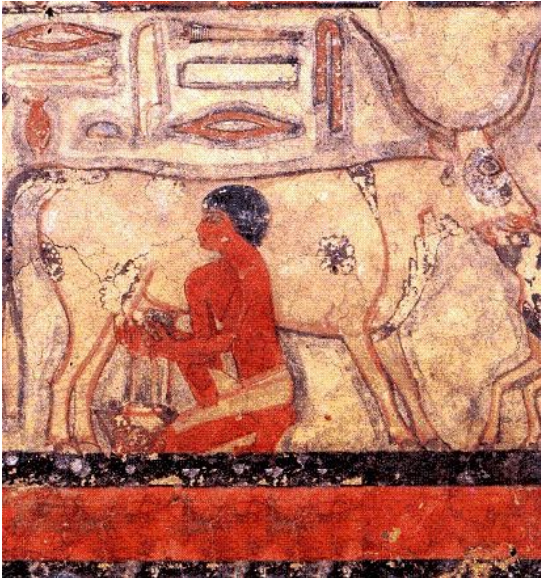


Table 7.4 Amino acid composition of milk proteins

<i>Amino acid</i>	<i>Lactalbumin</i>	<i>β-Lactoglobulin</i>	<i>α</i>	<i>Caseins</i>	
				<i>β</i>	<i>γ</i>
Glycine	2.9	3.1	2.5	2.2	1.4
Alanine	1.9	1.8	3.3	1.5	2.1
Valine	4.2	4.1	5.7	9.0	9.5
Leucine	10.4	9.2	7.1	10.2	10.8
Isoleucine	6.1	6.4	5.8	4.9	4.0
Proline	1.4	1.6	7.4	14.1	15.3
Phenylalanine	4.0	4.8	4.2	5.1	5.2
Tyrosine	4.8	4.5	7.3	2.8	3.3
Tryptophan	6.3	6.6	1.4	0.6	1.1
Serine	4.3	4.1	5.7	6.0	5.0
Threonine	5.0	4.9	4.4	4.5	4.0
Cystine	5.8	5.7	0.4	0.0	0.0
Methionine	0.9	0.8	2.3	3.0	3.7
Arginine	1.0	1.4	3.9	3.0	1.7
Histidine	2.6	3.0	2.6	2.7	3.3
Lysine	10.4	9.6	8.0	5.7	5.6
Aspartic	16.8	17.1	7.6	4.3	3.6
Glutamic acid	11.6	11.4	20.3	20.4	20.6

Results are taken from Gordon and Ziegler³⁵, Block and Weiss³⁸, Gordon *et al.*³⁷ and Gordon *et al.*³⁸ and are converted to weight per cent of total.

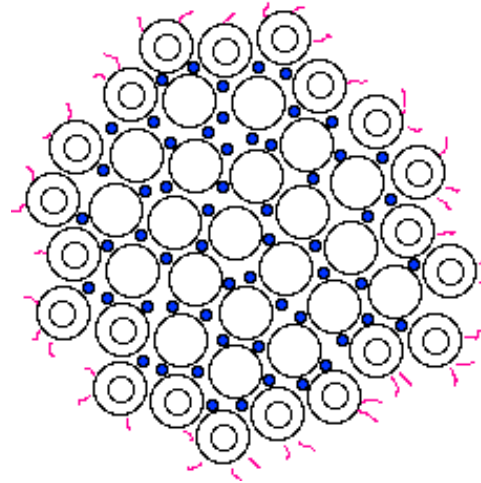


Kasein a kaseináty

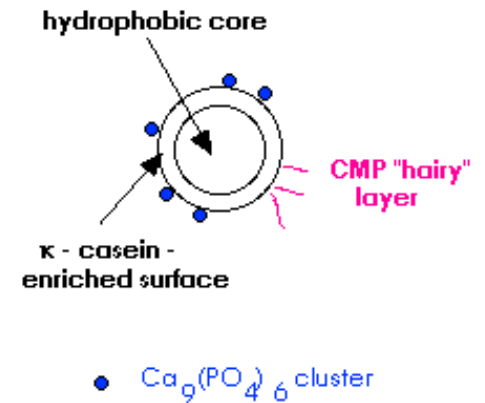
Vysoký obsah fosforu (cca 1 %; fosforečná kyselina esterifikuje hydroxylové skupiny serinu a částečně též glutamové kyseliny)



Casein Micelle



Casein Submicelle



Použití kaseinu

Pojivo pigmentů pro fresky (kaseinát vápenatý)

Lepidlo (přeměna kaseinátu na gel + síťování díky reakci s Ca)

Kaseinová tempera

Galalit (umělá rohovina, kasein + formaldehyd)

Zahřátím mléka dochází k inaktivaci enzymů (ireverzibilní změny konformace), kasein se částečně defosforyluje.

Důkaz α -kaseinu (tepelně degradovaného a defosforylovaného) v keramických střepech může sloužit i jako důkaz zpracování mléka. Mléko obsahuje cca 1,4 % (m/V) α -kaseinu

Důkaz kaseinu v keramice

důkaz
konzumace
mléka

druhá
příslušnost
Mléka
(kravské vs.
kozí)

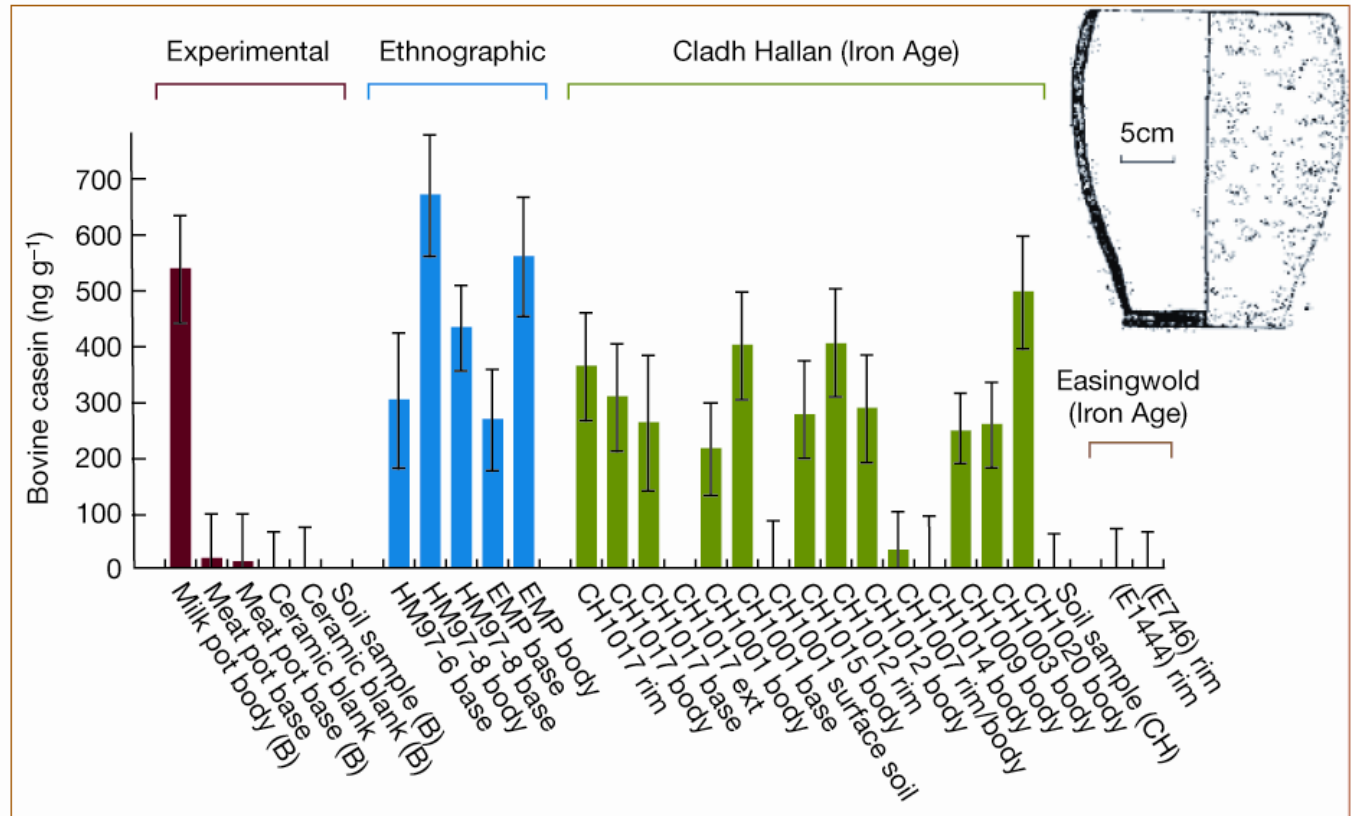


Figure 1 Amounts of bovine α -casein present in samples of pottery and soil, as determined by duplicate assay using digestion-and-capture immunoassay with a monoclonal antibody raised against this protein. Error bars, one standard deviation. The assay is specific only for cows' milk and is able to detect as little as 100 ng protein per g of ceramic (0.1 p.p.m.). Experimental coarseware pots (ceramic 'blank') were used to boil either milk (milk pot) or beef (meat pot) repeatedly and were buried for 1 year in upland soil. Ethnographic pots were obtained from Pakistan (HM) and India (EMP); each had been recently used to prepare dairy products. Cladh Hallan (CH) vessels (inset) were collected from a single site (fill of house 112, South Uist, Outer Hebrides). Domestic cooking pots from Easingwold, North Yorkshire (E), contained large amounts of well-preserved animal fats.

Krevní proteiny

- **Plazma**

albumin

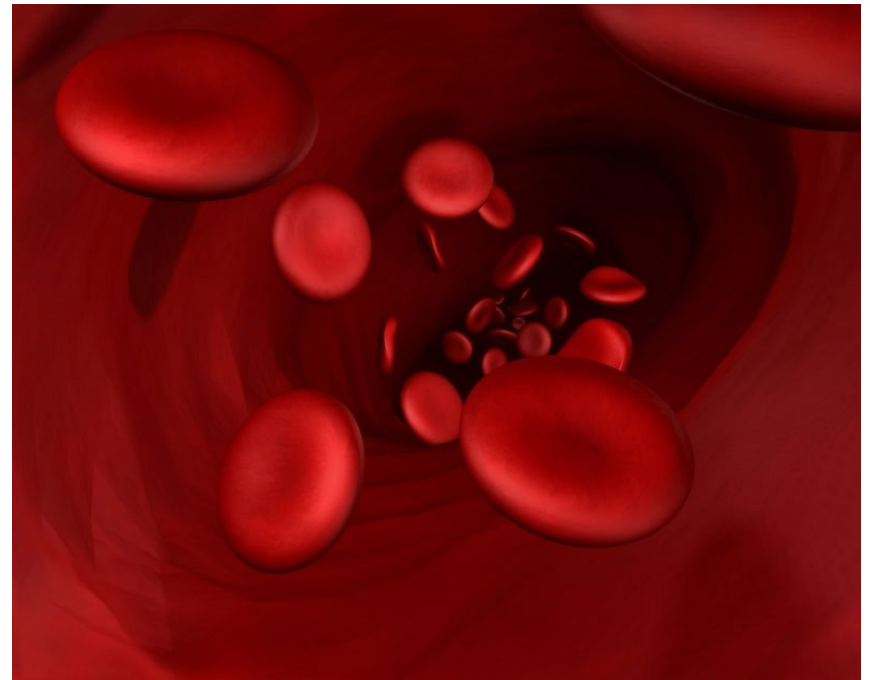
α -2HS-glykoprotein (A2HS)

transferrin

- **Červené krvinky**

proteiny krevních skupin

hemoglobin



Hemoglobin

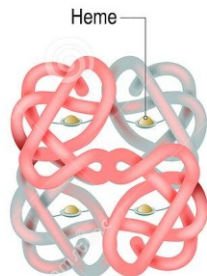
Přenašeč kyslíku, obsažen v červených krvinkách (erythrocytech).



Structure of hemoglobin



Red blood cell (erythrocyte)

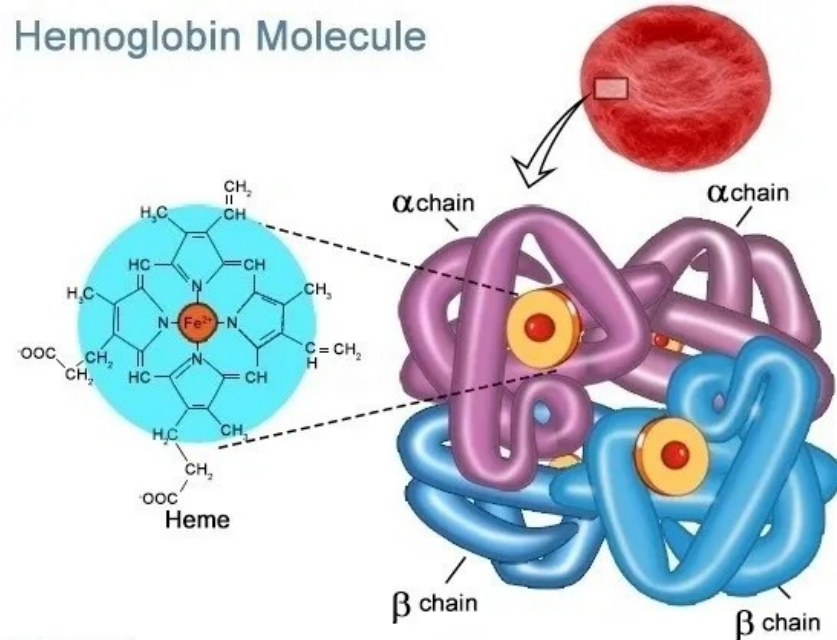


Hemoglobin molecule

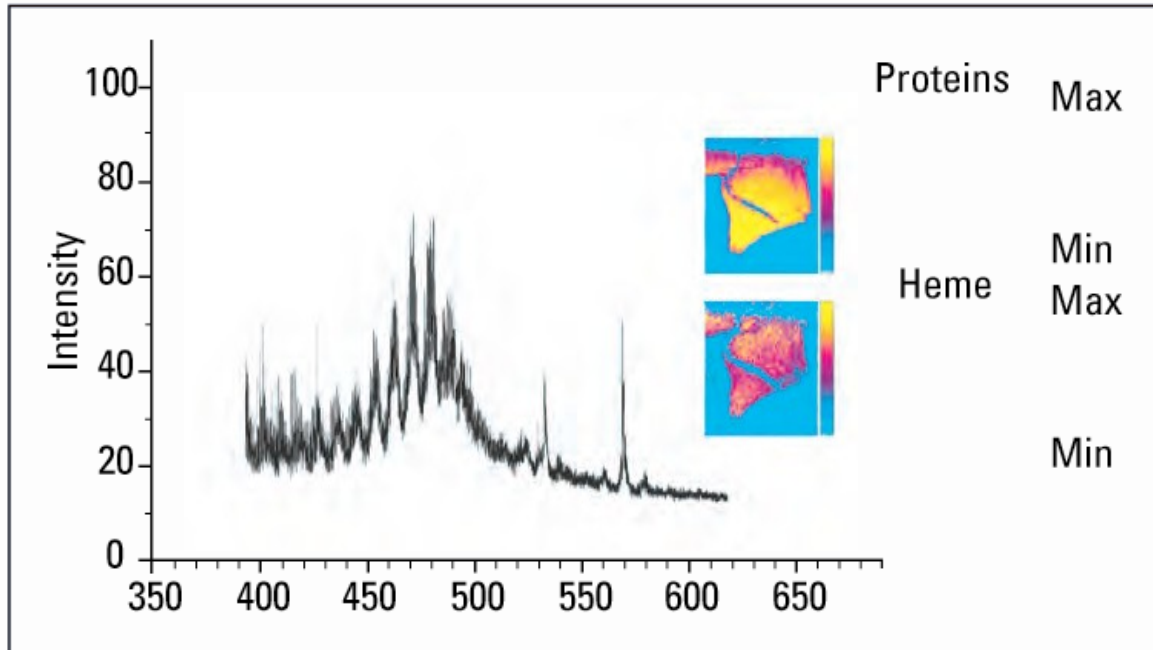


Heme b group

Hemoglobin Molecule



Recentní kultovní sošky z Mali



TOF SIMS analysis of an African artifact, highlighting the characteristic m/z 616.2 peak of heme as well as the overlapping spatial distribution of proteins (sum of amino acid fragments) and heme (tripyrrole fragments) on the sample's surface.



Hemoglobin

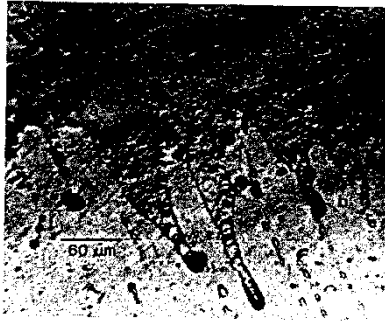


Fig. 1. Residual blood film (a) on the surface of an obsidian flake knife (b) (Photographed with incident light and Nomarski contrast apparatus). This artifact (sample IgSk 7:34) was excavated from a site in northern British Columbia. It is firmly associated with, and probably, older than, a radiocarbon date of 2830 ± 210 years.

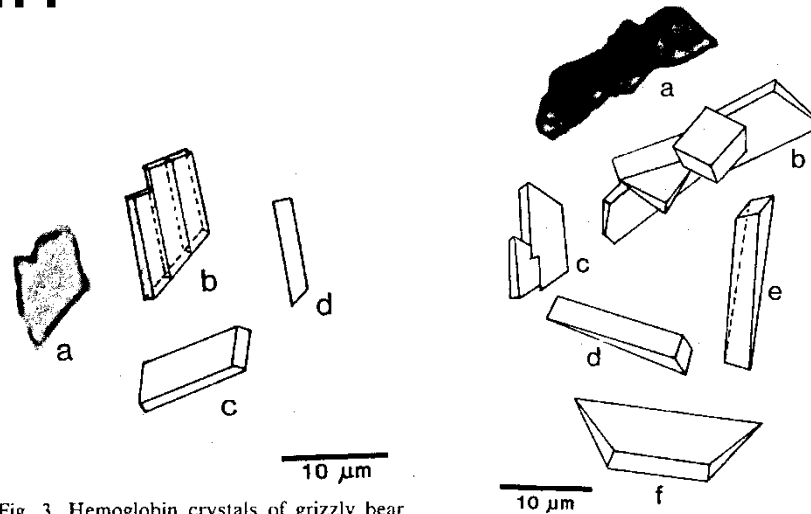


Fig. 3. Hemoglobin crystals of grizzly bear (*Ursus arctos horribilis*) grown from the blood film on the flake knife illustrated in Fig. 1: (a) photograph of a crystalline aggregate; (b) line drawing of the crystalline aggregate; (c and d) crystal forms grown from a modern control blood smear by the same technique (16).

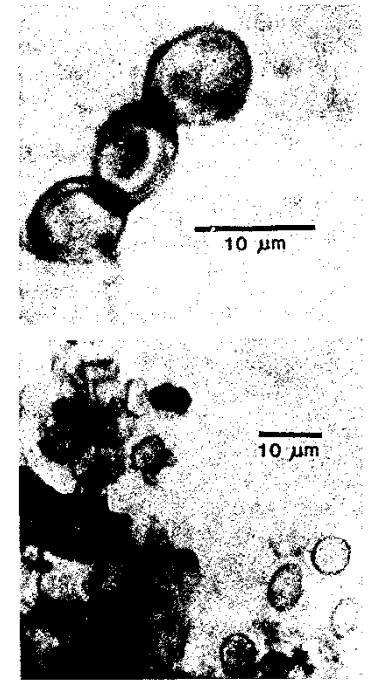


Fig. 4. Red blood cells in a plaque of dried blood removed from the surface of a flake knife (sample IgSk 8:85) excavated from a site in northern British Columbia (stained with *o*-phthaldialdehyde and illuminated in transmitted light with a quartz-halogen lamp and a Schott blue-violet filter to increase contrast).

Teichmann (hematinový test)

Fenoftalein

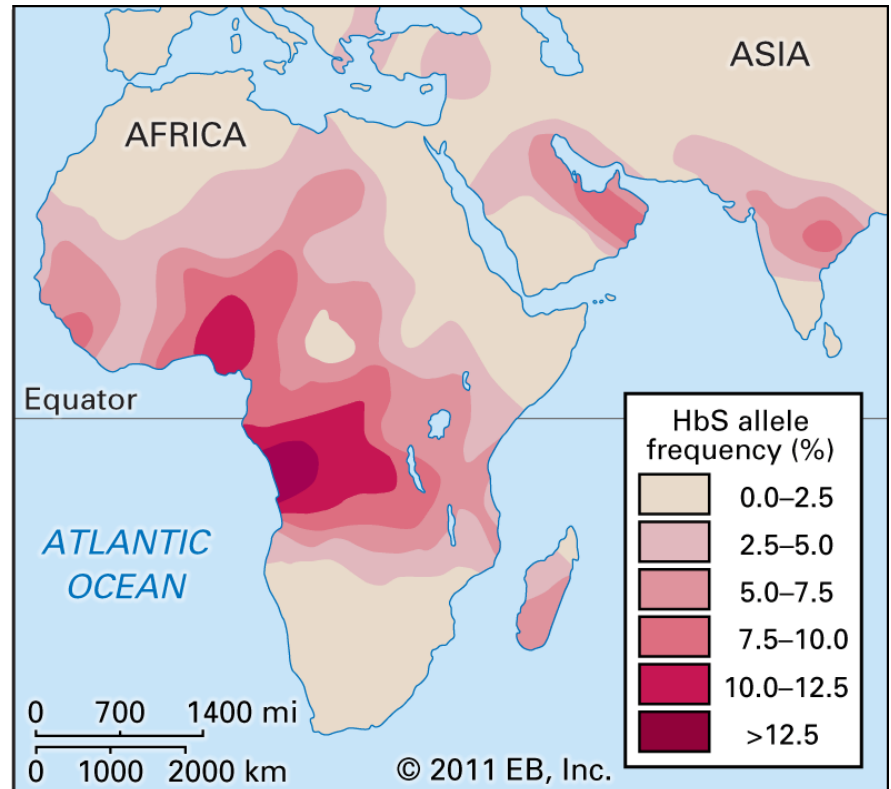
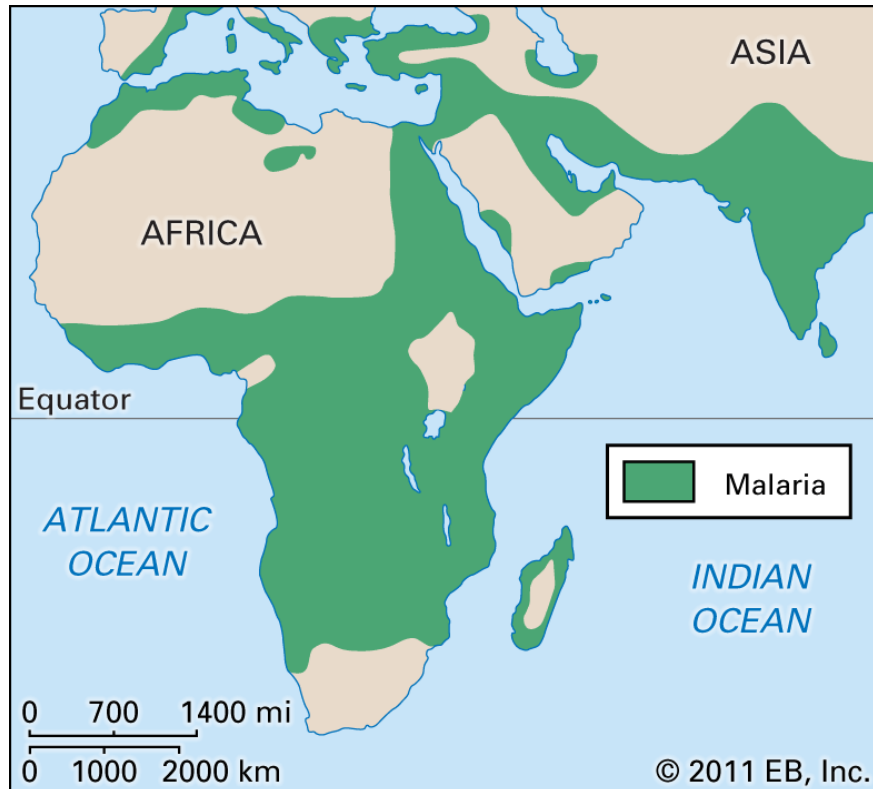
Luminol



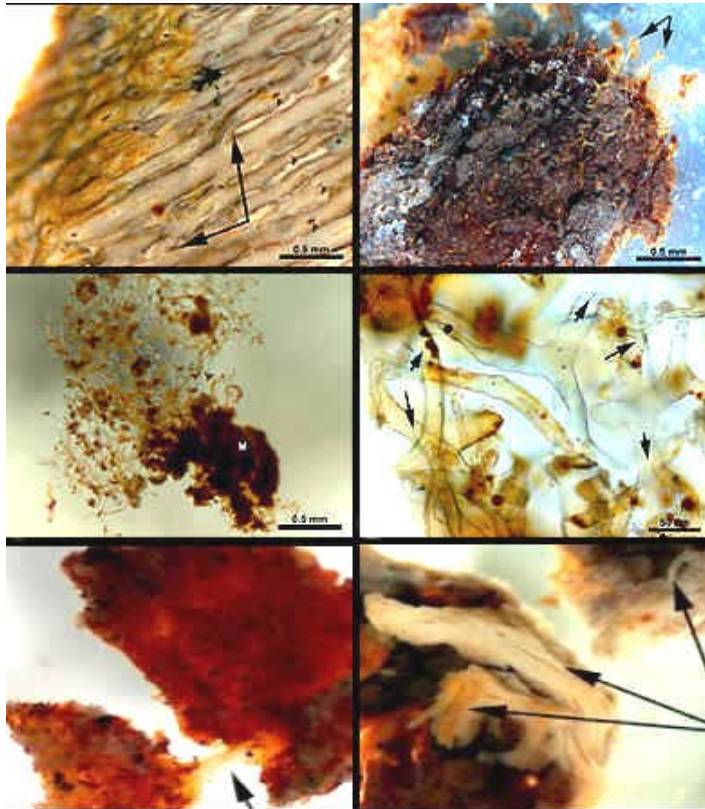
Srpkovitá anemie

Genetická choroba způsobená záměnou glutamové kyseliny za valin v β -řetězci hemoglobinu. Způsobuje srpkovitý tvar erythrocytů.

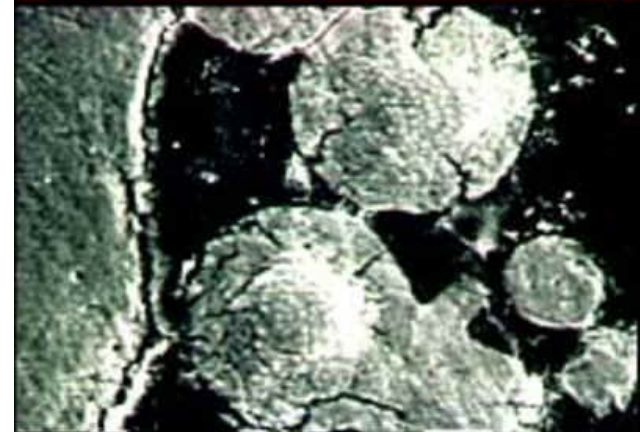
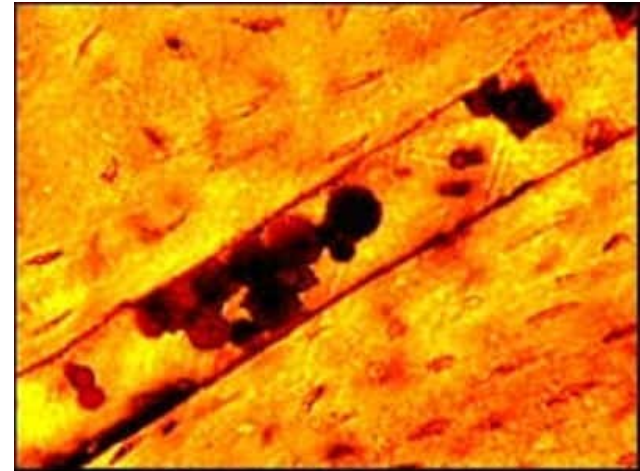
U heterozygotů poskytuje selekční výhodu při onemocnění malárií (prvok *Plasmodium falciparum*),



Fossilní pozůstatky krve ?



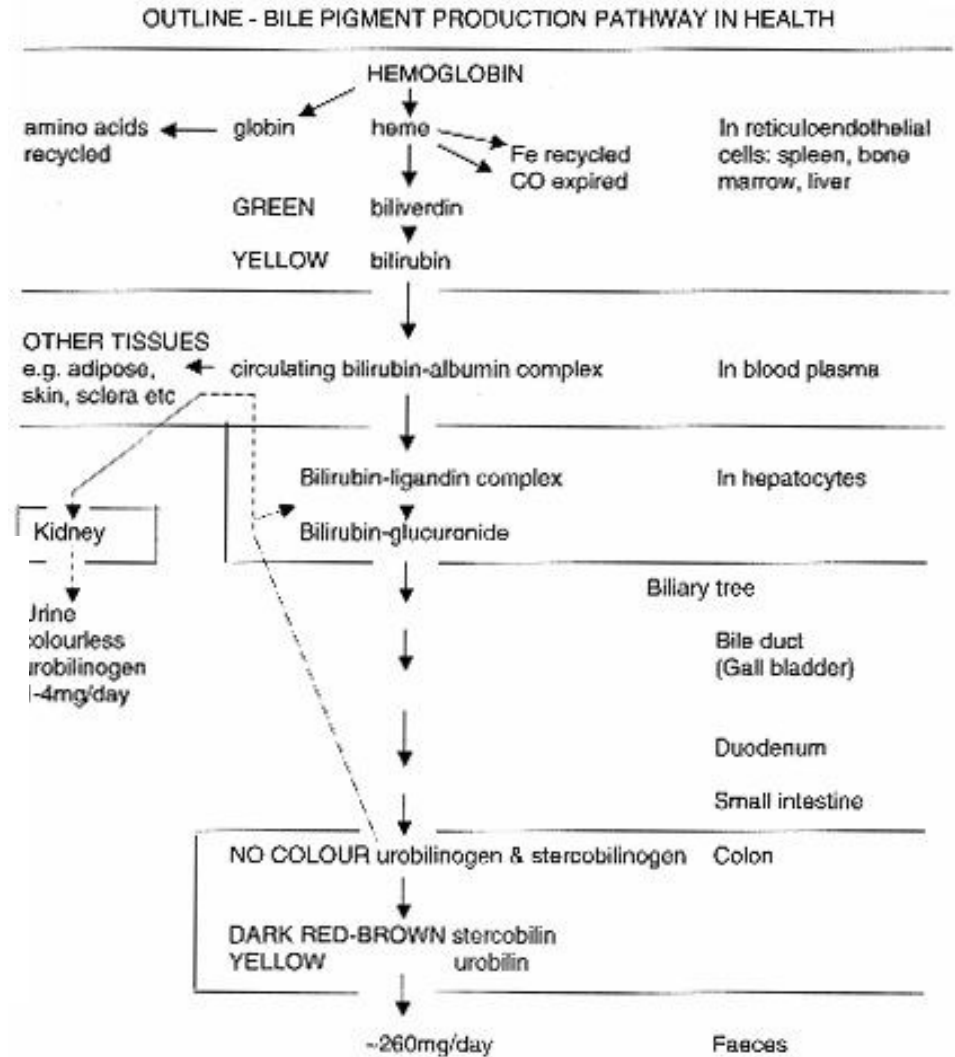
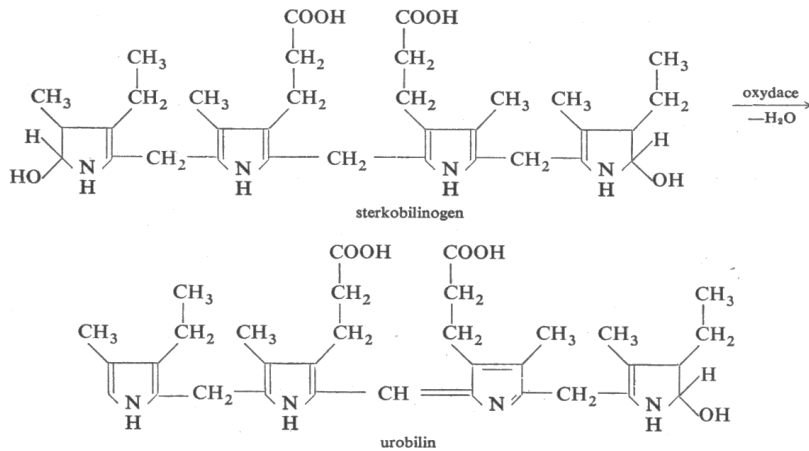
Tyrannosaurus rex thigh bone with soft tissues found inside - including delicate blood vessels with what appear to be red blood cells and bone forming osteocytes.



Red blood cell-like bodies in *T. rex* bone. Microscopic view of *T. rex* Haversian Canal (above) and scanning electron micrograph of these red blood cell-like bodies (below).

Urobilin

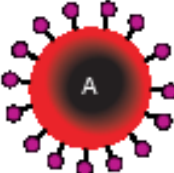
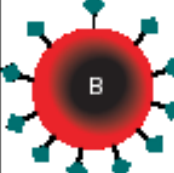
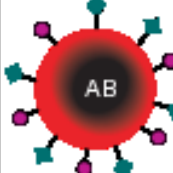
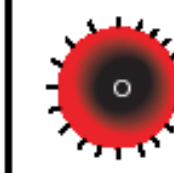






biomarker fekálního znečištění, vyskytuje se v moči a exkrementech. Způsobuje žlutou barvu moči. Vzniká bakteriální redukcí bilirubinu.



Proteiny krevních skupin

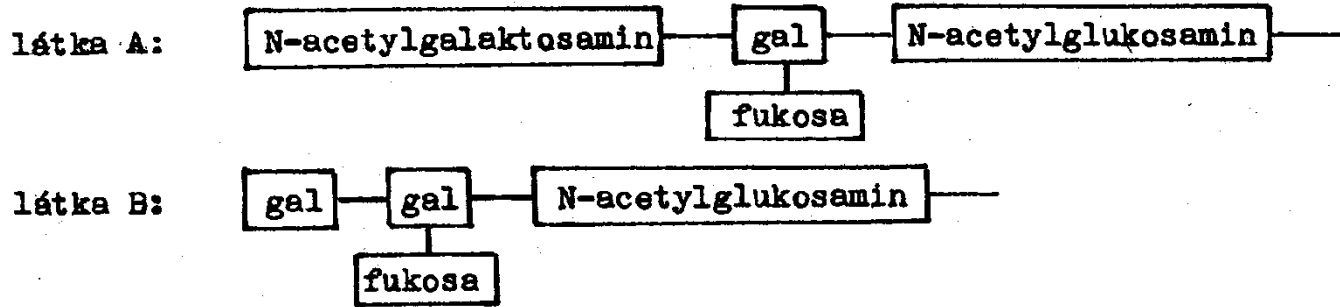
Antropologie: určování příbuzenství mezi jedinci u živých jedinců i na pohřebištích

Kriminalistika: identifikace osob

	Group A	Group B	Group AB	Group O
Red blood cell type				
Antibodies present	 Anti-B	 Anti-A	None	 Anti-A and Anti-B
Antigens present	 A antigen	 B antigen	 A and B antigens	No antigens



Glykoproteiny krevních skupin



U krevní skupiny 0 tyto sacharidy chybí.

K odštěpení sacharidů z glykoproteinů může dojít i vlivem saprofytních plísní – falešná přítomnost skupiny 0.

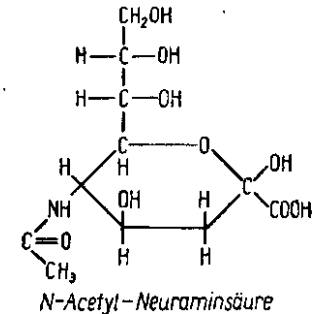
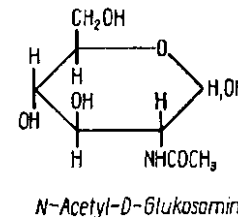
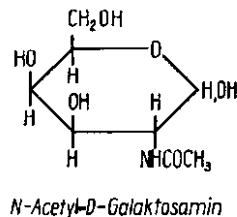
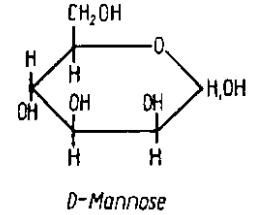
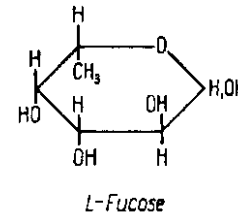
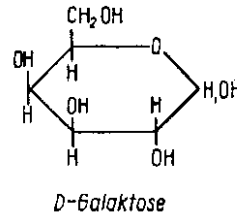
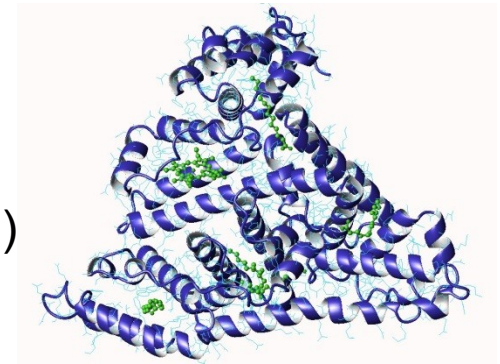


Abb. 69. Die wesentlichen Zuckerbausteine von Blutgruppensubstanzen

Albumin

Identifikace druhové příslušnosti kostí (např. ovce vs. koza) a krevních skvrn.



„Molekulární paleontologie“

- sledování rozdílů v imunologické podobnosti mezi druhy

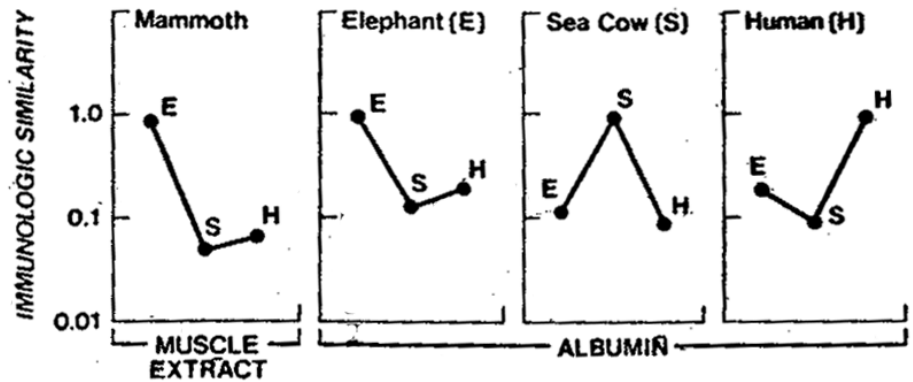
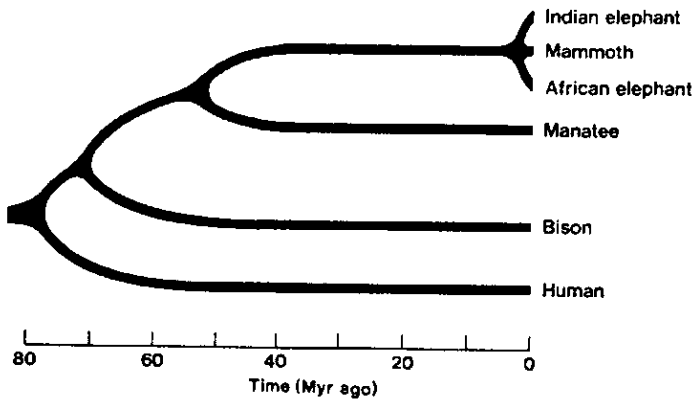
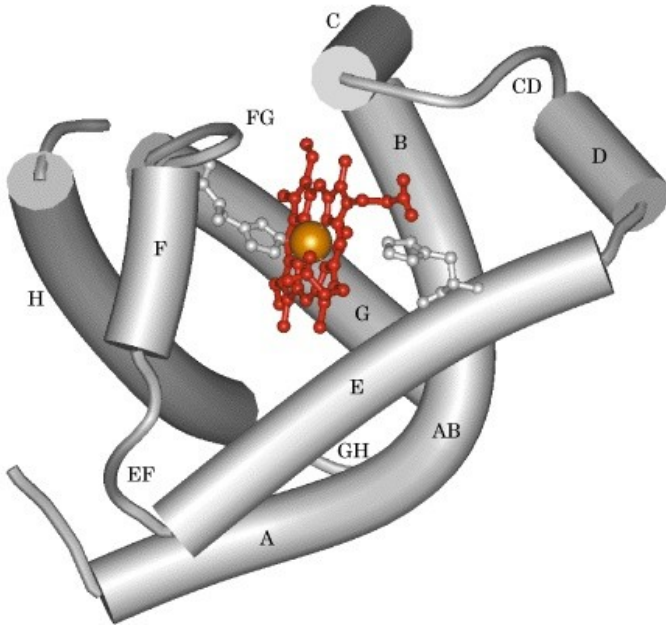


Fig. 4. Extract of mammoth muscle reacts with antisera to albumin like elephant albumin, not like sea cow (manatee) or human albumin. The sea cow is believed to be a very distant relative of the elephant

Nelze ho detekovat ve spálených kostech (teplota nad 300 C)

Myoglobin

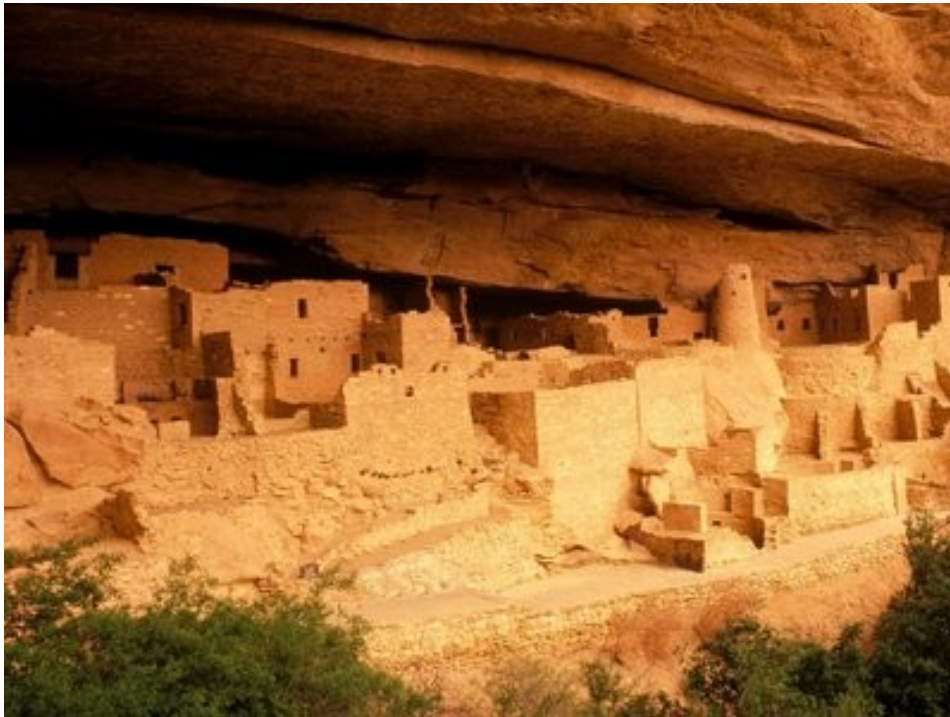
Vyskytuje se výhradně v příčně pruhované a srdeční svalové tkáni.



Sval	Obsah myoglobinu (mg/g čerstvé tkáně)
M. temporalis	18,5
M. pectoralis maior	33,1
M. rectus abdominis	54,1
Bránice	29,4
M biceps brachii	31,5
Svaly jazyka	15,3

Myoglobin

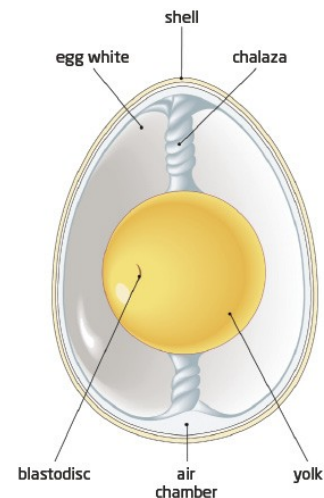
Přítomnost lidského myoglobinu v koprolitech (subfosilních exkrementech) a keramice prokázala kanibalismus u historických Anasaziů.



Anasazi (Pueblané, JZ USA)

Vaječné proteiny

- **Žloutek:** proteiny + tuky (nevysychavý olej) + lecithin (fosfatidyl cholin, = ionogenní emulgátor) + cholesterol (ochranný koloid) + lutein (žluté barvivo)



vitellogenin

- **Bílek:** vysoký obsah vody, žádný tuk

ovalbumin (cca 60% všech proteinů)

Table 7.3 Amino acid compositions of egg white proteins.

<i>Amino acid</i>	<i>Ovalbumin</i>	<i>Conalbumin</i>	<i>Lysozyme</i>
Glycine	2.9	5.0	5.3
Alanine	4.5	3.8	6.3
Valine	6.6	7.1	4.1
Leucine	8.4	7.6	6.2
Isoleucine	6.6	4.3	4.6
Proline	3.2	4.3	1.4
Phenylalanine	7.0	5.0	2.9
Tyrosine	3.3	4.0	3.2
Tryptophan	1.2	2.7	6.0
Serine	7.6	5.5	7.4
Threonine	3.8	5.1	5.6
1/2 cystine	1.7	1.7	5.7
Methionine	4.8	1.8	1.8
Arginine	5.3	6.6	10.2
Histidine	2.2	2.2	0.9
Lysine	5.9	8.8	5.2
Aspartic	8.6	11.6	17.2
Glutamic acid	15.4	10.4	4.3
Ammonia	1.1	1.1	1.8

Results are taken from Haurowitz³³ and Jolles³⁴, and converted to weight per cent of total.

Vaječné proteiny

- **Žloutek**
 - Pojiva temperových barev (někdy celá vejce) – vysychání vody (nemění se molekulární struktura)
- **Bílek**
 - Pojivo barev pro iluminované rukopisy (křehkost)



Tempera se připravuje rozmícháním barviva s vaječným žloutkem. Používala se na nástěnných malbách v Egyptě, Babylónii i Řecku. Používala se v renesanční Itálii, zde postupně ustoupila olejovým barvám.

Albuminová fotografie

Papír napuštěný vaječným bílkem s NaCl se potírá dusičnanem stříbrným. Zbarvení fotografií bývá červenohnědé. Přítomnost bílku způsobuje postupné žloutnutí fotografií. Nejvíce se používala cca v letech 1855 - 1895



TABLE : COMPARISON OF AMINO ACIDS BETWEEN ALBUMINS (g/100g OF PROTEIN)

AMINO ACIDS :	OVALBUMIN	LACTALBUMIN	BSA
LYSINE :	6.6	11.5	12.8
HISTIDINE :	2.3	2.9	4.0
ARGININE :	5.9	1.2	5.9
ASPARTIC ACID :	9.4	18.7	10.9
THREONINE :	4.5	5.5	5.8
SERINE :	8.1	4.8	4.2
GLUTAMIC ACID :	16.1	12.9	16.5
PROLINE :	3.6	1.5	4.8
GLYCINE :	3.2	3.2	1.8
ALANINE :	5.8	2.1	6.3
HALF CYSTINE :	2.4	6.4	6.5
VALINE :	7.1	4.7	5.9
METHIONINE :	4.9	1.4	0.8
ISOLEUCINE :	7.0	6.8	2.6
LEUCINE :	10.1	11.5	12.3
TYROSINE :	3.9	5.4	5.1
PHENYLALANINE :	5.4	4.5	6.6
TRYPTOPHAN :	1.2	5.3	0.6

Rostlinné proteiny

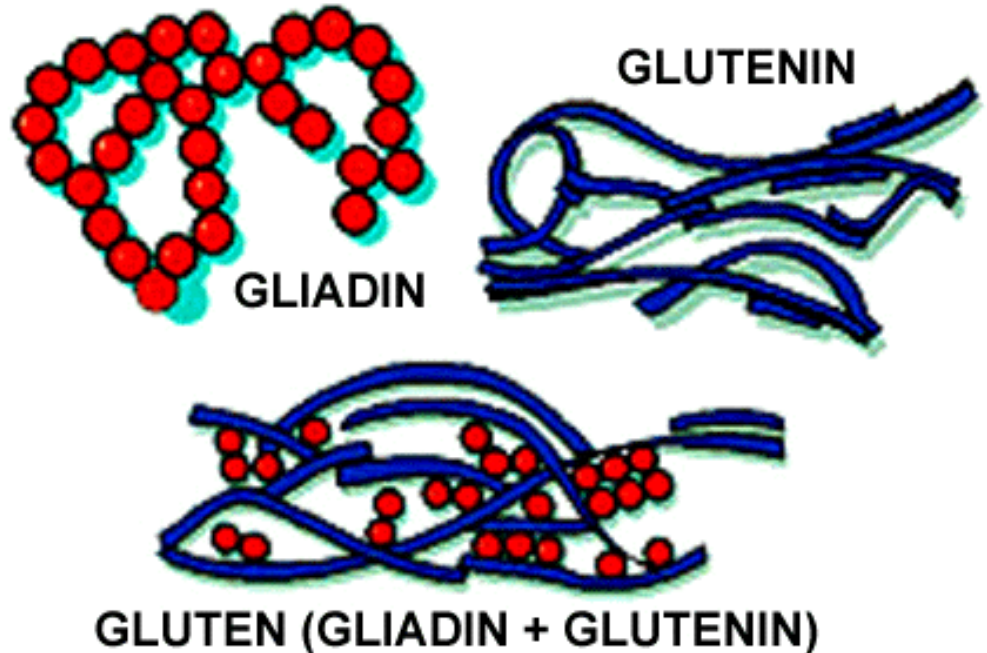
Zejm. luštěniny a obiloviny. Použití jako adheziva a pasty.

Albuminy

Globuliny

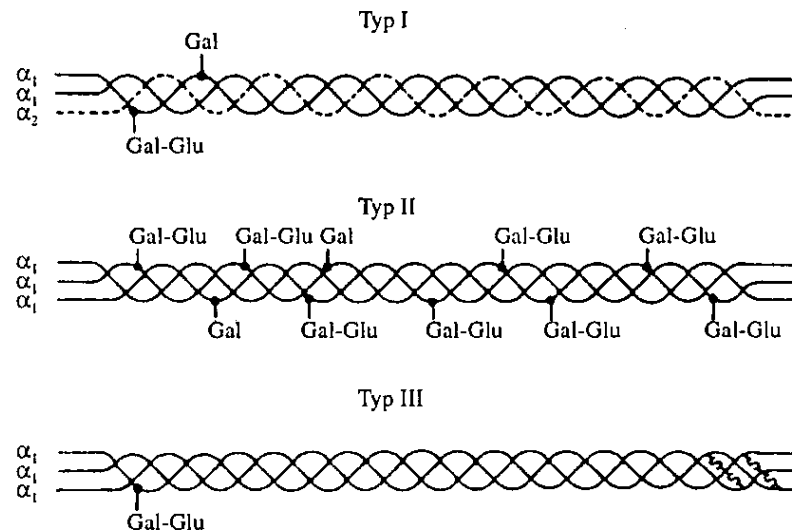
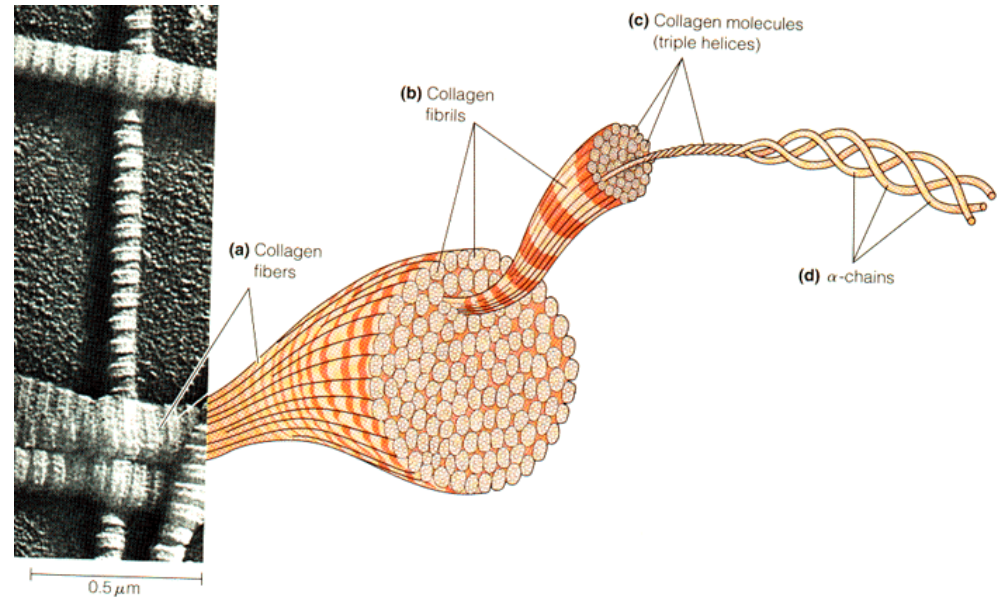
prolaminy a gluteliny

- Zein (kukuřice)
- Hordein (ječmen)
- Gliadin (pšenice)
- Legumin (čočka)
- Edestin (semeno konopí)
- Amandin (mandle)



Kolagen

Denaturací kolagenu vzniká
želatina a klíh



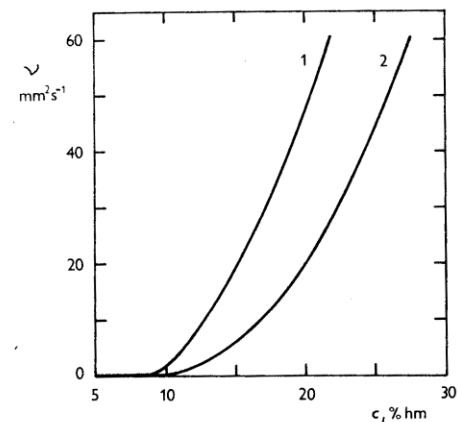
Obr. 1. Schéma tří typů kolagenu. Je patrné rozdílné zastoupení jednotlivých typů polypeptidových řetězců a různý stupeň glykosylace. Disulfidové síťování je naznačeno jen u typu III (převzato z cit.²⁰ s laskavým svolením Wiley & Sons, Inc., Copyright 1987)

Tab. 2. Charakteristika jednotlivých typů kolagenu

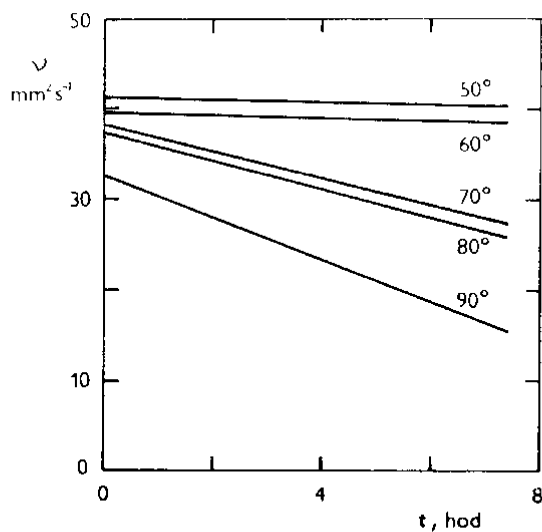
Typ kolagenu	Složení řetězců	Délka molekuly, prostorové uspořádání	Distribuce v tkáních
I	$[\alpha_1(\text{I})_2\alpha_2(\text{I})]$	300 nm, periodičita 67 nm	většina tkání, hlavně kost, šlacha, kůže, cévy
I (trimer)	$[\alpha_1(\text{I})_3]$	300 nm, periodičita 67 nm	v malém množství přítomen v typu I
II	$[\alpha_1(\text{II})_3]$	300 nm, periodičita 67 nm	chrupavka, meziobratlová ploténka, sklivec
III	$[\alpha_1(\text{III})_3]$	300 nm, periodičita 67 nm	ve fetálních tkáních, kůži, plicích, artériích (totožný s retikulínem)
IV	$[\alpha_2(\text{IV})_2\alpha_3(\text{IV})]$	390 nm, netvoří vlákna	bazální membrány
V	$[\alpha_1(\text{V})\alpha_2(\text{V})\alpha_3(\text{V})]$	300 nm, netvoří vlákna	placenta, kůže, většina matrix
VI	$[\alpha_1(\text{VI})\alpha_2(\text{VI})\alpha_3(\text{VI})]$	105 nm, tvoří dimery	krevní cévy, děloha, ligamenta, kůže, plíce
VII	$[\alpha_1(\text{VII})_3]$	450 nm, antiparalelní dimery	membrány amnia, kůže, jícen
VIII	$[\alpha_1(\text{VIII})_3]?$?	endotelové buňky
IX	$[\alpha_1(\text{IX})\alpha_2(\text{IX})\alpha_3(\text{IX})]$	200 nm	chrupavka, sklivec, meziobratlová ploténka
X	$[\alpha_1(\text{X})_3]$	150 nm, globulární peptid na C-konci	chrupavka
XI	$[\alpha_1(\text{XI})\alpha_2(\text{XI})\alpha_3(\text{XI})]$? ?	chrupavka

Klíh

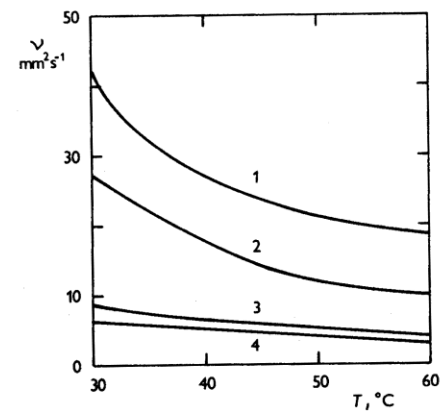
Vyrábí se z kostí a kůží,
používá se jako adhezivum



Obr. 11 Závislost kinematické viskozity η vodného roztoku klišu na koncentraci c . 1 – kožní kliš, 2 – kostní kliš.



Obr. 13 Závislost kinematické viskozity η na době zahřívání t při různých teplotách vodného roztoku kožního klišu $^{\circ}$.



Obr. 12 Závislost kinematické viskozity η vodných roztoků klišu na teplotě T . 1–17,75 % roztok kožního klišu, 2–15 % roztok kožního klišu, 3–17,75 % roztok kostního klišu, 4–15 % roztok kostního klišu.



Nejstarší známý klíh z jeskyně Nahal Hemar v Izraeli
(8310-8110 BP podle 14C)

Želatina

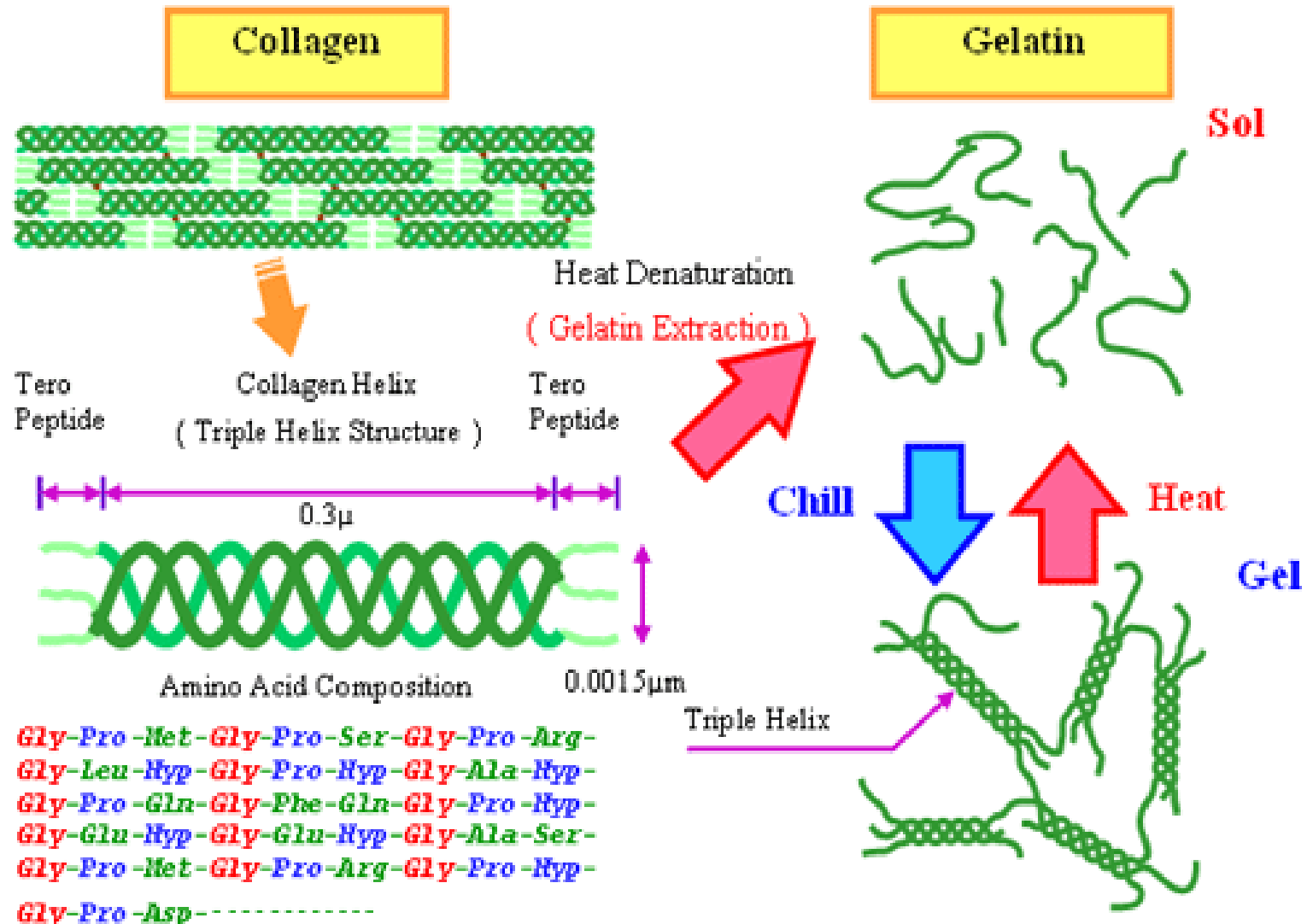
Želatina je velmi čistý a jemný klíh, který se získává vyvařením šlach, kůží, kostí a jiných jatečných odpadů bohatých na kolagen. Vařením se kolagen přeměňuje na glutin, což je látka, která má rosolovací schopnost a je nejpodstatnější složkou želatiny (rozrušení šroubovicové struktury). Želatina se používá především v potravinářství a k výrobě tobolek na léčiva, dříve též fotografických emulzí.



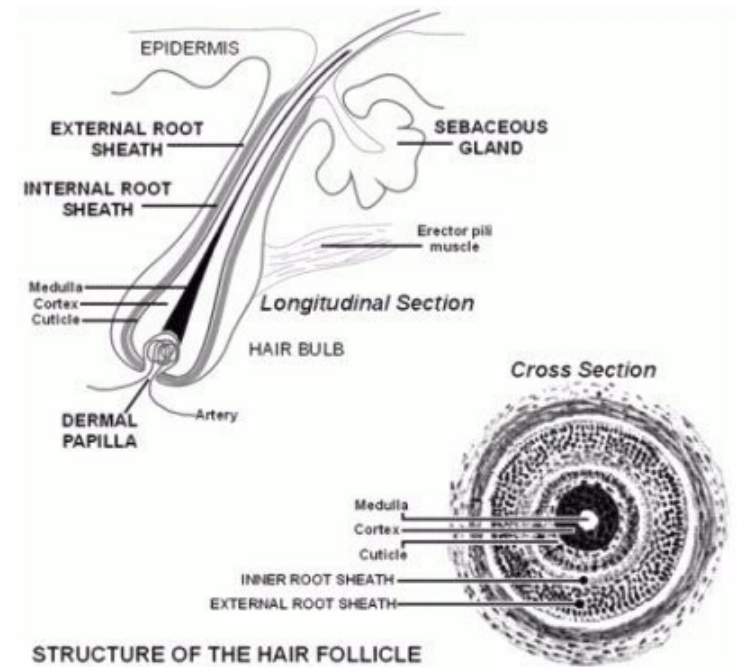
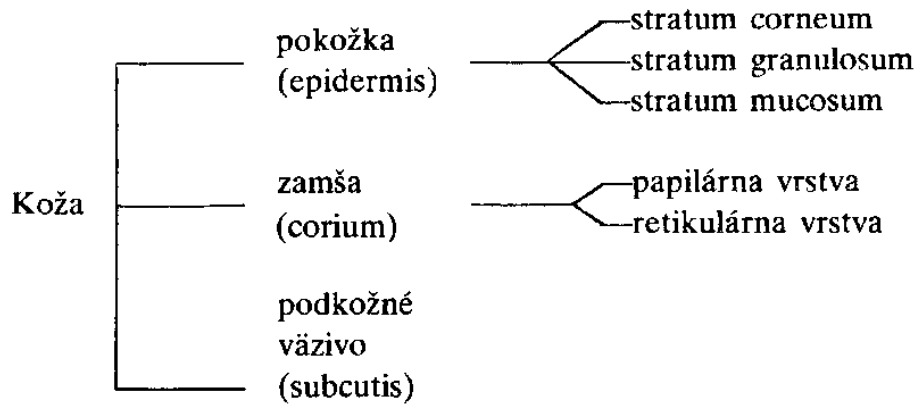
Bow & Lougheed



Želatina



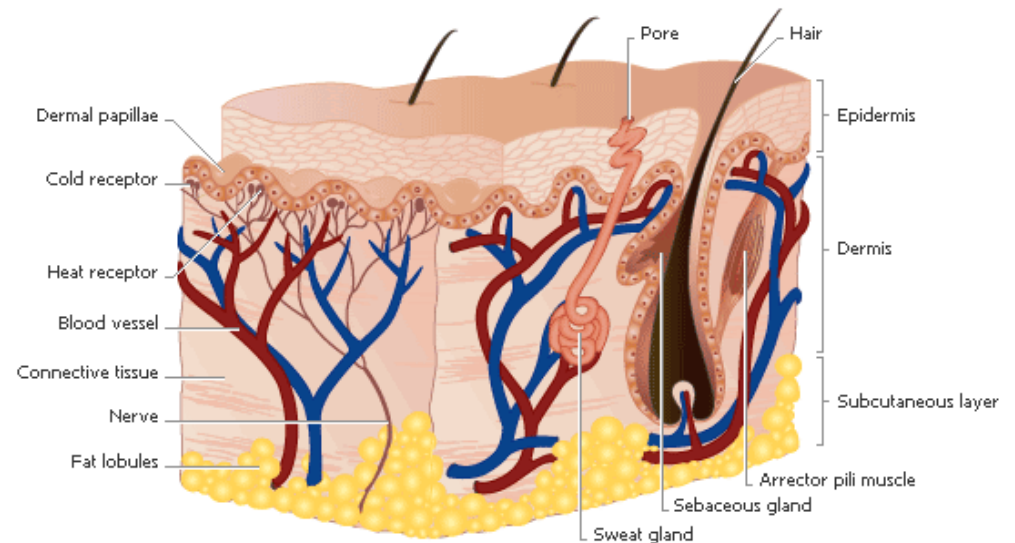
Kůže a ušeň



Kolagen

Elastin

Retikulin



Výroba usně

1. konzervování surové kůže sušením nebo solením: ochrana před mikrobiálním napadením.
2. máčení (námok): rehydratace kolagenových vláken, odstranění rozpustných solí a globulárních proteinů z prostor mezi kolagenovými vlákny.
3. loužení ve vápenném mléce: vytváří podmínky pro uvolnění chlupů. Vysoká alkalita vyvolává také botnání kůže a štěpení svazků kolagenových vláken (to umožňuje lepší přístup činících látek strukturou kolagenu); zároveň probíhá další vymývání rozpustných bílkovinných látek a hydrolýza tuků.
4. mechanické odstranění chlupů a podkožního vaziva (mízdření).



Mízdření a odstraňování chlupů



"Eygentliche Beschreibung aller Stände auff Erden ...
J. Amman a H. Sachs /Frankfurt am Main / 1568 /



Le tanneur. Der Lohgerber. The tanner.



S. Amerika (Odžibwejové) přelom 19. A 20. století

Výroba usně

5. Odvápnění = neutralizace přebytku vápna působením kyselin a amonných solí. Neutralizací se sníží botnání kůže, uvolní se kolagenová vlákna, struktura se stává měkkou a propustnou pro vodu a vzduch.

6. Moření = rozpuštění koagulovaných mezivláknitých bílkovin (enzymy – holubí a psí trus)

7. Praní ve vodě – vzniká „holina“

8. Činění = reakce aminoskupin kolagenu s činícími látkami (formaldehyd, třísloviny, soli kovů)

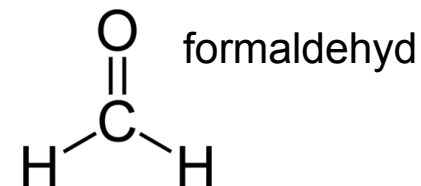
9. Mazání – přidávání tuků a olejů pro udržení resp. zvýšení ohebnosti a pevnosti. Vyčiněná a vysušená useň (cca 50% vlhkosti) směsí olejů a tuků (treskový, ricinový, olivový, paznehtový olej), lanolin aj.

Mokrý useň po činění (likrování): emulze olejů ve vodě, jako emulgační činidlo bylo použito mýdla a žloutku.

10. Měkčení a sušení

Uzení

do usně proniká formaldehyd z kouře, který může interagovat s volnými aminoskupinami proteinu (vznik Schiffových bází).



Měkčení usně

mechanicky



Pergamen

Pergamen je nevydělaná při napětí sušená a hlazená zvířecí kůže. Používá se kůže různých domácích zvířat, např. oslů, vepřů, koz, ovcí nebo hovězího dobytka, zpravidla mladších jedinců, jejichž kůže je jemnější.

Ve evropských druzích pergamenu rozlišujeme tři základní typy:

- **Jihoevropský** (italský) je jemněji zpracován jen po masové straně, na kterou se píše, druhá zůstává hrubší a žlutá;
- **Středoevropský** je zpracován oboustranně stejně (méně jemně) a píše se na obě strany.
- **Byzantský** se navíc potírá bílkem a více se vyleští.



Výroba pergamenu

Počáteční fáze stejná jako u usně: máčení, loužení ve vápenném mléce, odchlupení a někdy moření.

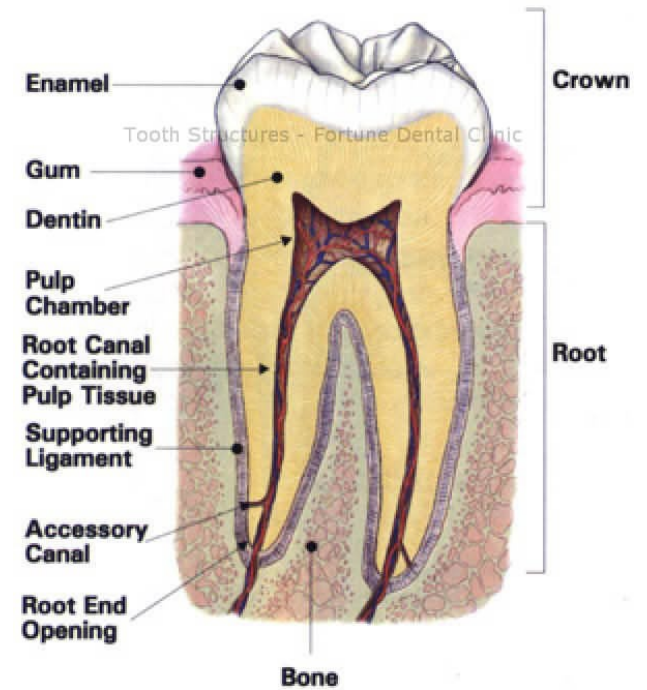
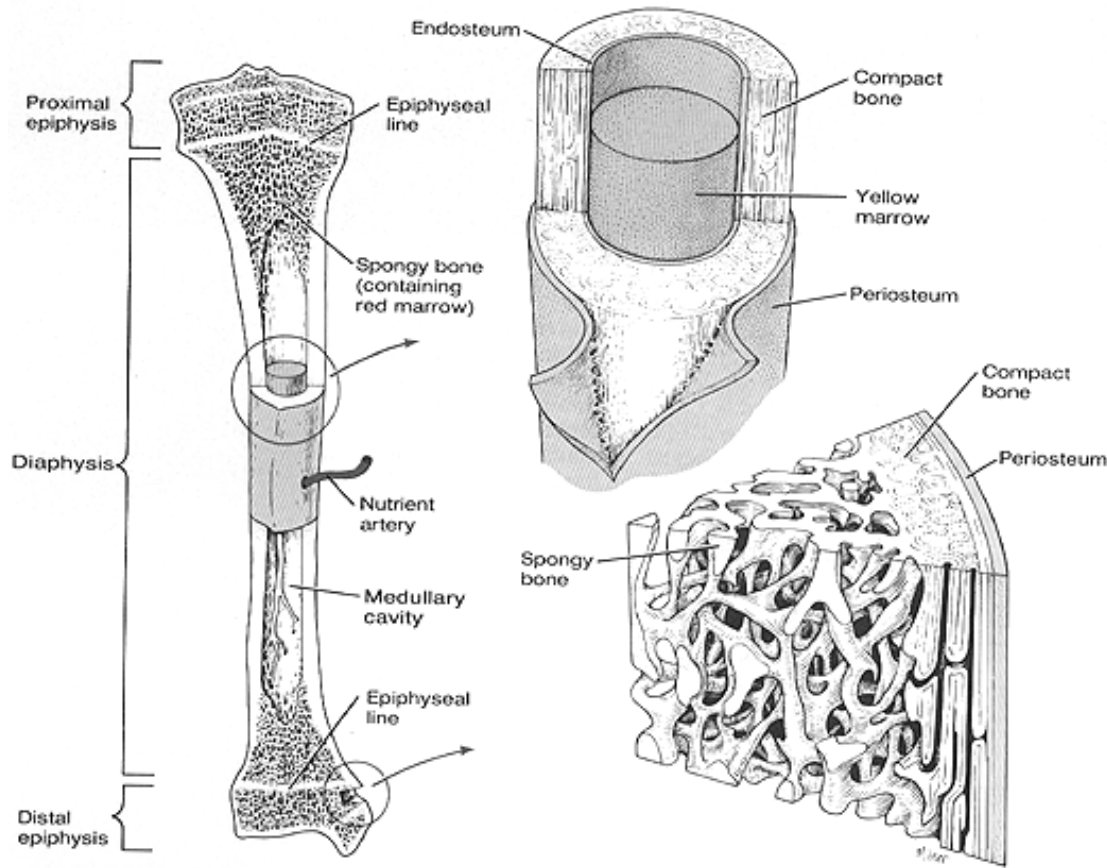
Získaná holina není odvápnována ani činěna; ve vlhkém stavu je napnuta na rám kde postupně vysychá a její tloušťka a povrch se škrábe, povrch je broušen, bělen, případně i barven, jsou do něj vtírána plniva (křída, vápno, mastek), je mazán a hlazen.



Jelikož nebylo provedeno odvápnění, zůstalo v pergamenu vázáno na karboxylové skupiny molekul kolagenu množství vápenatých iontů. To určuje odolnost pergamenu vůči kyselému prostředí (alkalická rezerva brání i růstu plísní) a makromolekuly zesíťované Ca ionty ztrácí pohyblivost a to vede ke tvrdnutí a křehnutí, ve vlhkém prostředí může vyvolávat hydrolýzu kolagenu a zejm. tuků (žloutnutí pergamenu).

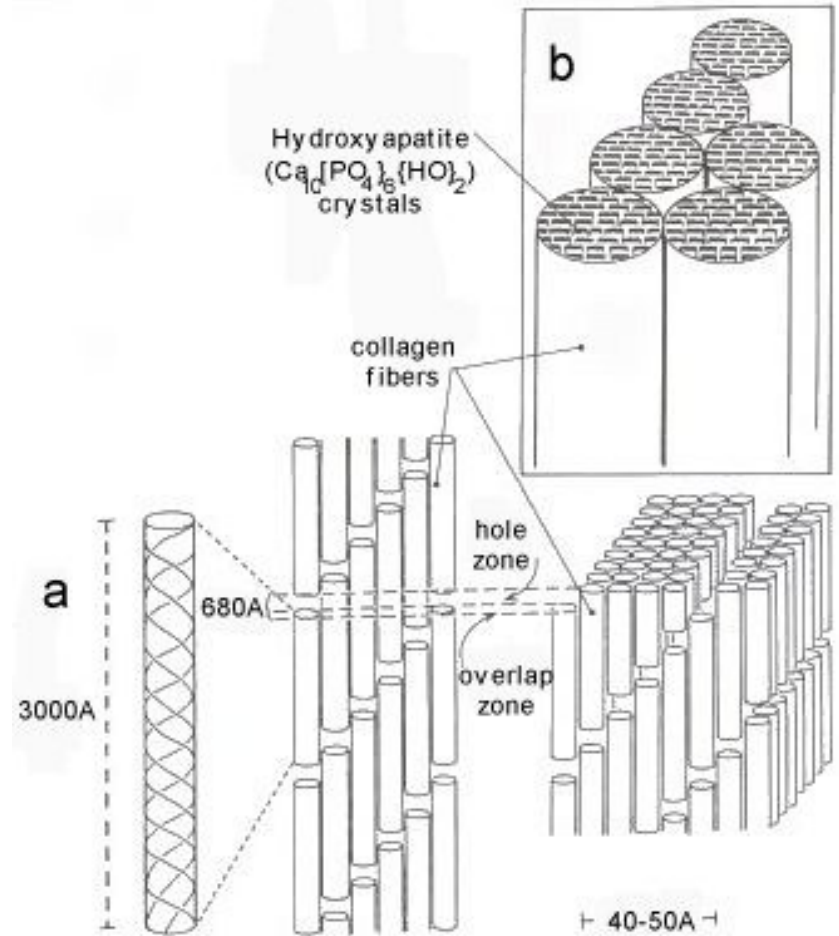
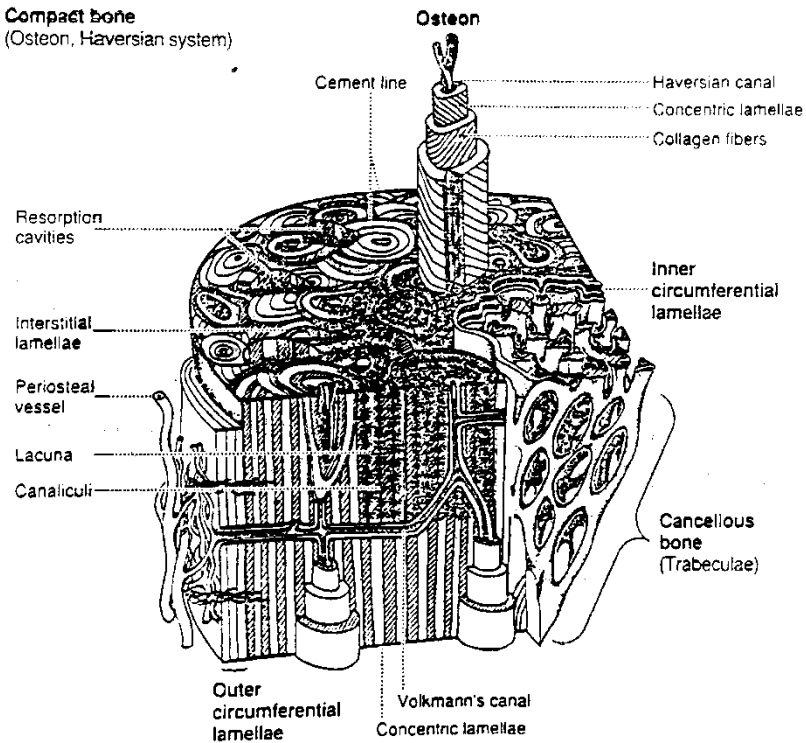
Kalcifikované tkáně

Kosti a zuby



Kalcifikované tkáně

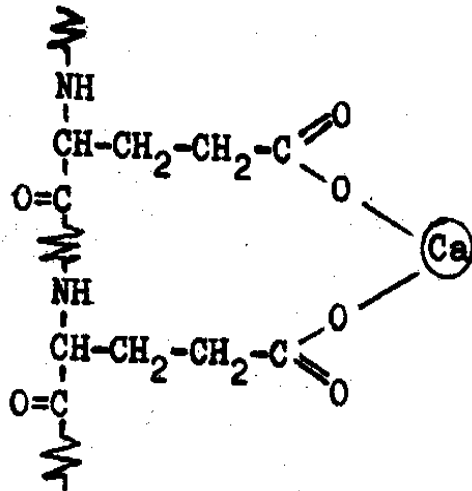
Compact bone
(Osteon, Haversian system)



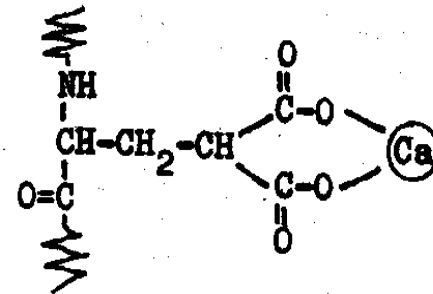
Nekolagenní proteiny kosti

Nekolagenní proteiny kosti: osteokalcin, osteonektin, proteoglykany, sialoproteiny.

Jsou to proteiny kyselé povahy s vysokou afinitou ke kostnímu minerálu. Jsou tak ve srovnání s kolagenem odolnější vůči degradaci a vymývání z kosti a mohou perzistovat mnohem delší dobu.



zbytky glutamátu v kolagenu a jiných proteinech



zbytky γ -karboxyglutamátu v osteokalcinu

Osteokalcin

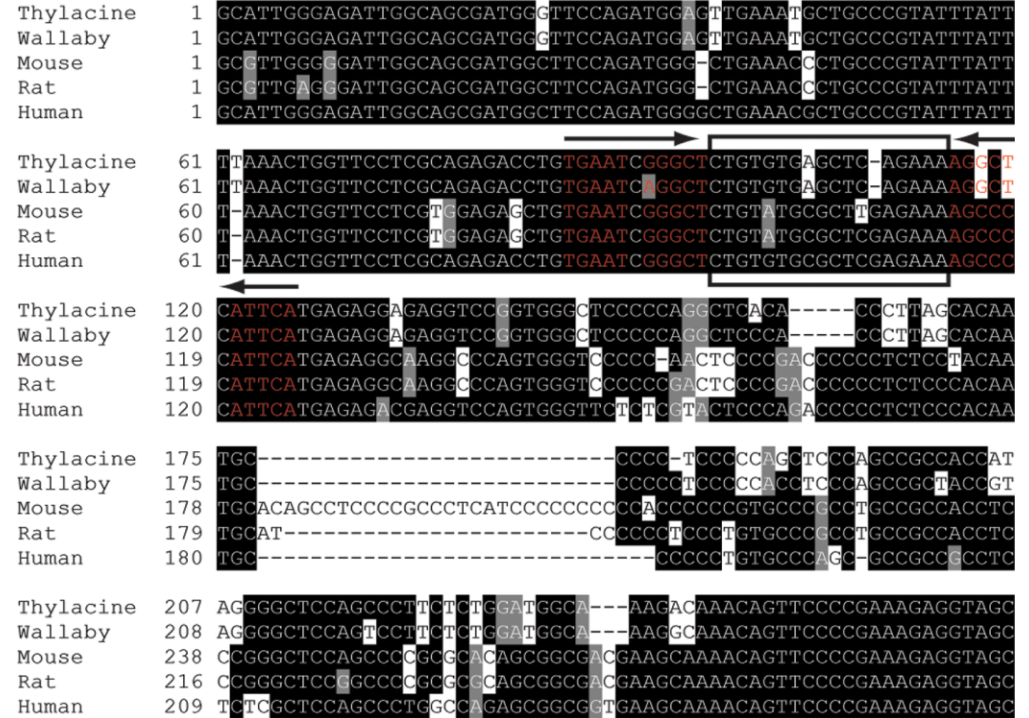
Molekulární paleontologie

Zdroj uhlíku pro ¹⁴C

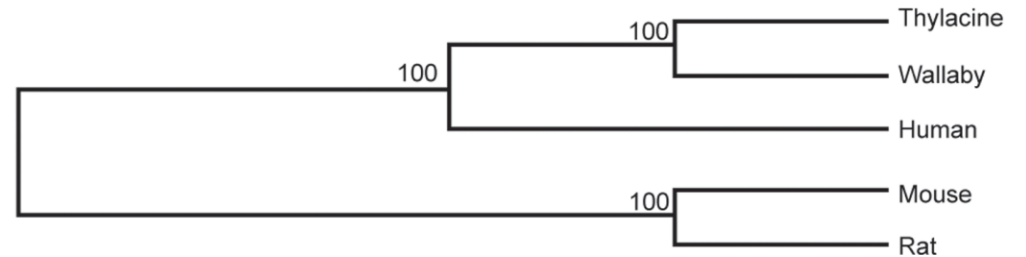


Šanidar, 75 000 BP

a



b



Voda

Voda je reakční prostředí pro řadu chemických i biochemických reakcí. Kůže obsahuje velmi malé množství vody (extrémní dehydratace), většina není vázaná (není součástí struktury tkáně).

Volná voda může interagovat s prostředím, její obsah se výrazně mění vlivem vnějších podmínek.

Vázaná voda je vázaná fyzikálně (sorpce, kapilární síly) a/nebo chemicky.

V suchém prostředí dochází k dehydrataci kolagenu. Molekuly vody uložené mezi molekulami kolagenu mají „změkčující účinek“, umožňují větší pohyblivost kolagenových vláken. Ztráta vody vyvolává uložení vláken ve svazcích do kompaktnější, méně pohyblivé struktury. Kůže tvrdnou a křehnou, jsou málo odolné vůči mechanickému namáhání (viz např. mumie).

Voda a vlhkost

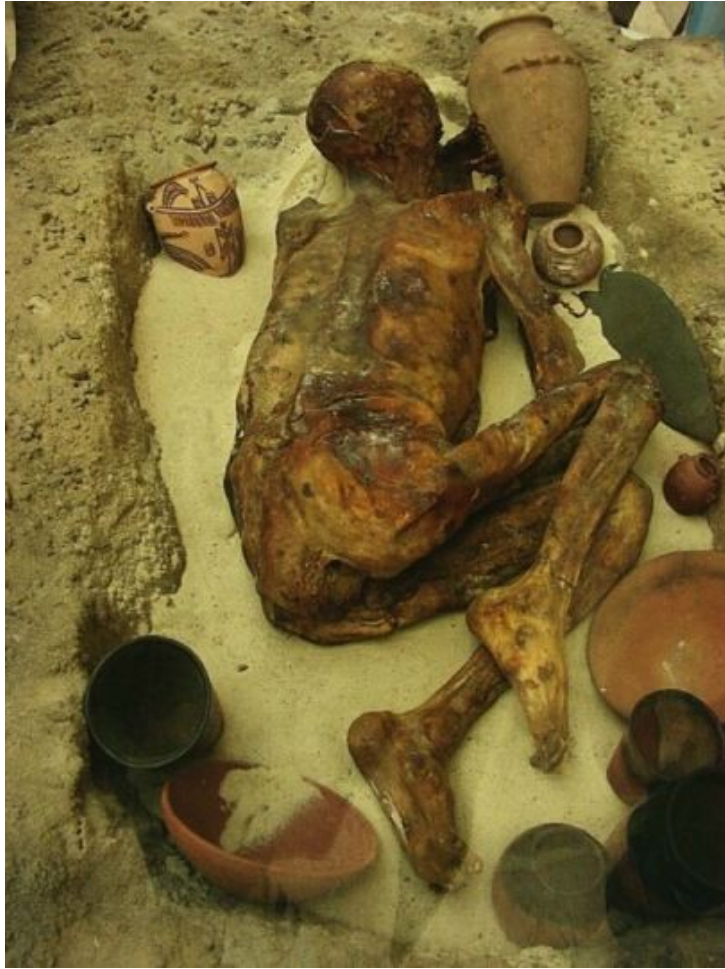
Termická analýza kůže (pokožka + škára), mumie Ötzi a recent (pítevní materiál)



Typ vody (% celk. hm.)	noha		hýždě	
	Ötzi	Recent	Ötzi	Recent
Volná	16,50	52,70	13,59	48,07
Chemicky vázaná	1,43	18,56	2,34	16,00
Celková	17,93	71,26	15,93	64,07

Nižší obsah vody v tkáních ve srovnání s pitevním materiálem

Přirozená mumifikace



„Ginger“ (Egypt)

Chinchorro
(Chile)



Palermo
(kapucínská
hrobka)



Přirozená mumifikace



Mamutí mládě
Lyuba
(Sibiř)



Člen Franklinovy
expedice
(King William Island)



Qilakitsoq (Grónsko)

Balzamování

- m.j. využíváno sušení pomocí natronu (přírodní soda), na základě osmotického jevu. Podobně funguje konzervace potravin nasolením



Keratin

Vlasy, chlupy, vlna

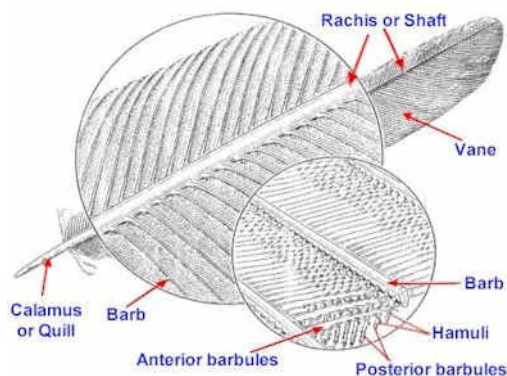
Peří

Rohovina

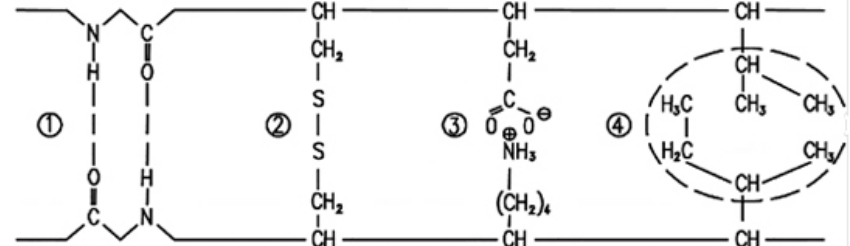
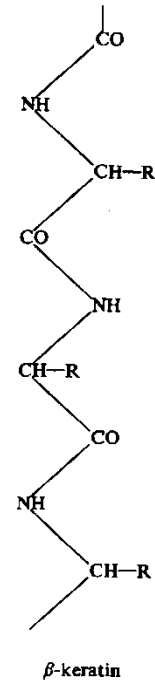
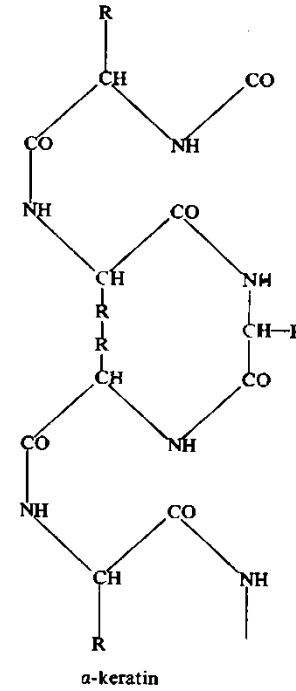
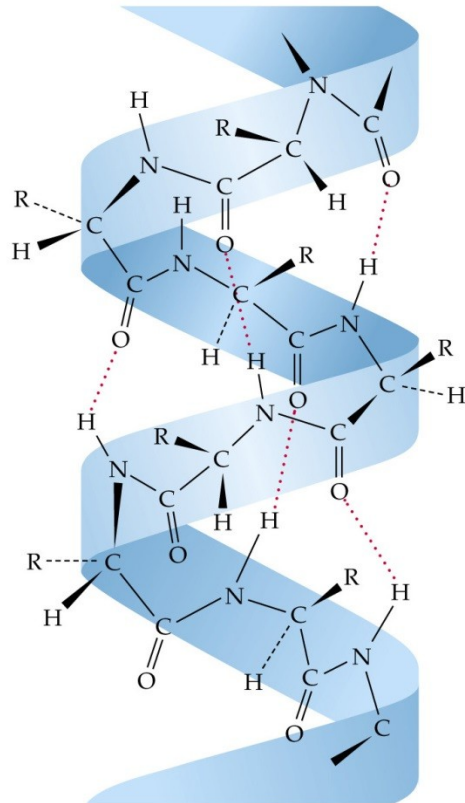
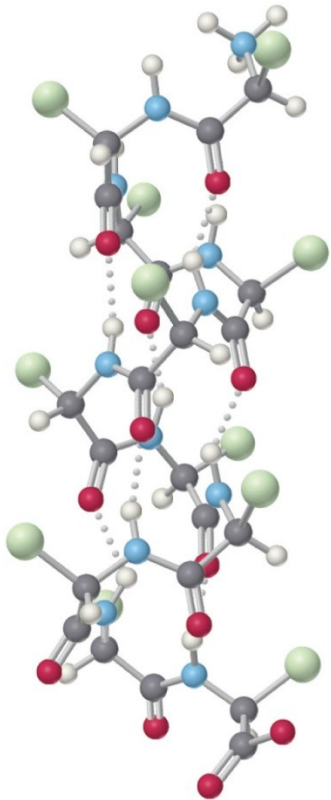
Želvodina

Tabuľka 12.1. Aminokyselinové zloženie (%) keratínu pokožky, ľudských vlasov, hovädzej rohoviny, slepačieho peria a bravčových štetín (Bowesová a Elliot, 1957)

Aminokyselina	Pokožka %	Vlasy %	Rohovina %	Perie %	Štetiny %
Glycín	10,36	4,1—4,2	9,6	7,2	
Alanín	4,32	2,8	2,5	5,4	
Valín	3,34	5,9	5,5	5,8	5,9
Leucín	8,33	6,4—8,3	8,3	7,4—8,0	8,3
Izoleucín	3,31	4,7—4,8	4,8	5,3—6,0	4,7
Fenylalanín	3,99	2,4—3,6	4,0	4,7—5,3	2,7
Tyrozín	4,7	2,2—3,0	5,6	2,0—2,2	3,5
Tryptofán	0,95	0,4—1,3	0,7	0,7	
Serín	11,51	7,6—10,6	6,1	4,4—4,8	
Treonín	4,33	7,0—8,5	6,1	4,4—4,8	6,3
Cystín	1,54	16,6—18,0	15,7	6,8—8,2	14,4
Metionín	1,64	0,7—1,0	2,2	0,4—0,5	0,5
Prolín	2,73	4,3—9,6	8,2	8,8—10,0	9,6
Arginín	5,65	8,9—10,8	10,7	6,5—7,5	10,9
Histidín	1,62	0,6—1,2	1,1	0,7	1,1
Lyzín	5,2	1,9—3,1	3,6	1,7	3,8
Kyselina asparágová	9,49	3,9—7,7	7,9	5,8—7,5	8,9
Kyselina glutámová	15,3	13,6—14,2	13,8	9,7	17,9
Amidový N	0,9	1,17	1,14	1,09	
Celkový N	19,6	15,5—16,9	16,9	16,2	
Celková síra	0,77	3,0—4,0	5,2	3,9	



Struktura keratinu



1. Hydrogen bridges between peptide groups (polar bond)
2. Cystine bridge (covalent bond)
3. Salt bridge between an asparagine and lysine side chain (ionic bond)
4. Hydrophobic bond between a rest of valine and isoleucine (non-polar bond). The broken ellipse shows the part where the water is displaced.

Keratinová vlákna

- Vlna ovčí
- Mohér (srst kozy angorské)
- Kašmír (srst kozy kašmírské)
- Velbloudí srst
- Srst lamy a alpaky
- Srst jaka



Vlna

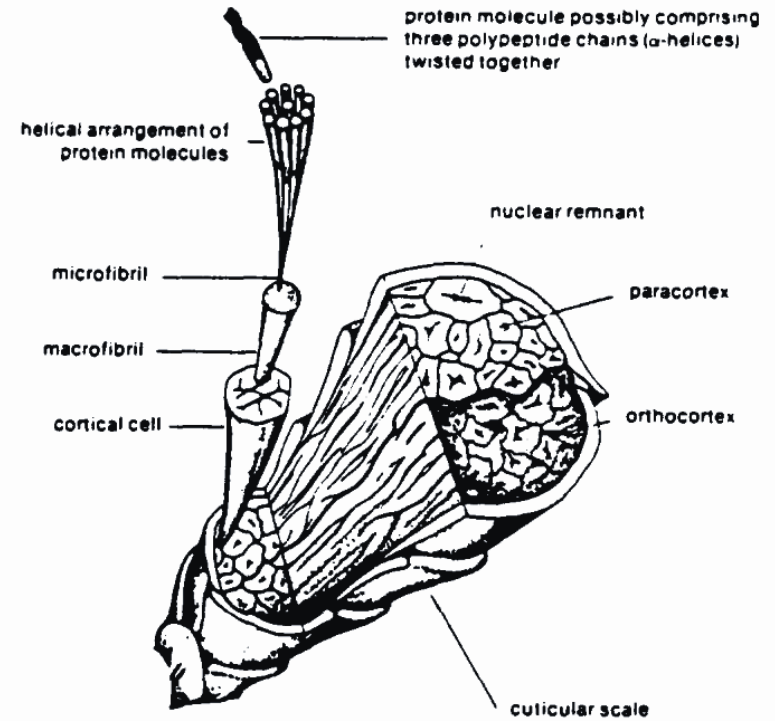
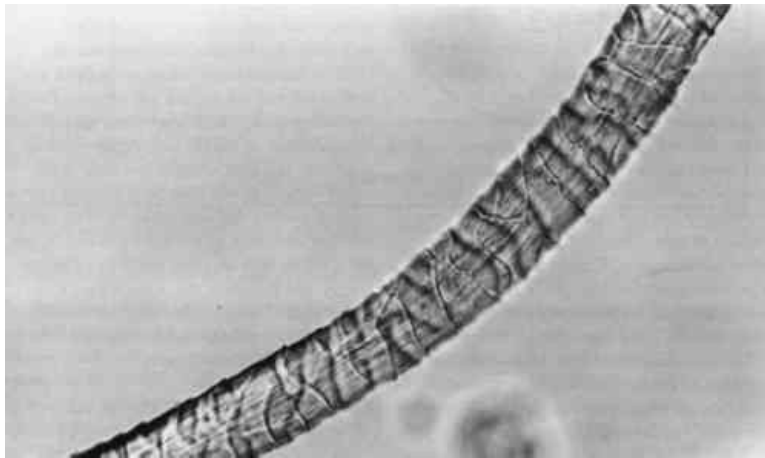
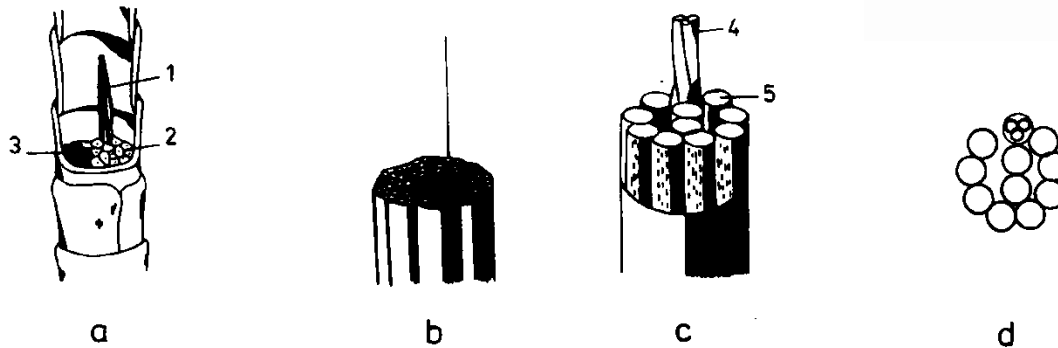


Fig. 1. Schematic drawing of a wool fibre.



Obr. 2-27. Štruktúra vlny

a – vlákno vlny, *b* – fibrila, *c* – mikro fibrila, *d* – prierez mikro fibrilou (2+9 protofibril); 1 – bunka kortexu, 2 – ortokortex, 3 – parakortex, 4 – tri- α -závitnica, 5 – protofibrila

Keratin

Tabuľka 12.2. Aminokyselinové zloženie keratínu vlny podľa rôznych literárnych údajov (% , resp. zvyšky aminokyseliny/100 aminokyselín)

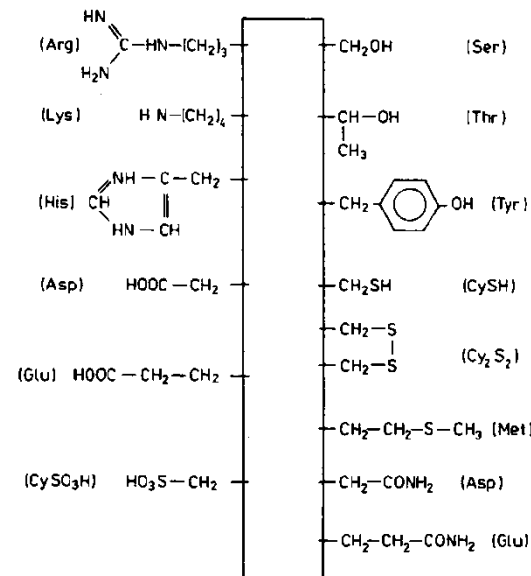
Aminokyselina	% (1)	% (2)	% (3)	zvyšok/100 AK (4)
Alanín	4,4	3,8	3,7	4,4—5,6
Amidový N	1,4	1,1	1,4	9,0—11,1
Arginín	10,4	9,2	10,5	6,0—6,9
Kyselina asparágová	7,3	6,4	6,7	5,5—6,2
Cystín	13,1	11,0	11,3	10,4—13,0
Kyselina glutámová	16,0	13,1	15,0	10,1—12,4
Glycín	6,5	5,3	5,2	7,8—9,9
Histidín	0,7	1,0	0,9	0,5—0,8
OH-lyzín	0,2			
Izoleucín		3,8	3,1	2,7—3,9
Leucín		7,7	7,6	6,6—7,8
Lyzín	3,3	3,1	2,8	2,2—2,6
Metionín	0,7	0,5	0,6	0,4—0,5
Fenylalanín	4,0	3,4	3,4	2,3—2,8
Prolín	7,2	6,4	7,3	5,2—8,0
Serín	9,5	7,2	9,0	7,8—10,2
Treonín	6,6	6,6	6,6	6,3—6,4
Tryptofán	1,8		2,1	1,0—1,1
Tyrozín	6,1	4,0	6,4	2,5—4,1
Valín	5,5	5,9	5,0	4,8—5,7

(1) Speakman (1949)

(2) Ward a kol. (1955)

(3) Simmonds (1955)

(4) Ward a Lundgren (1954)

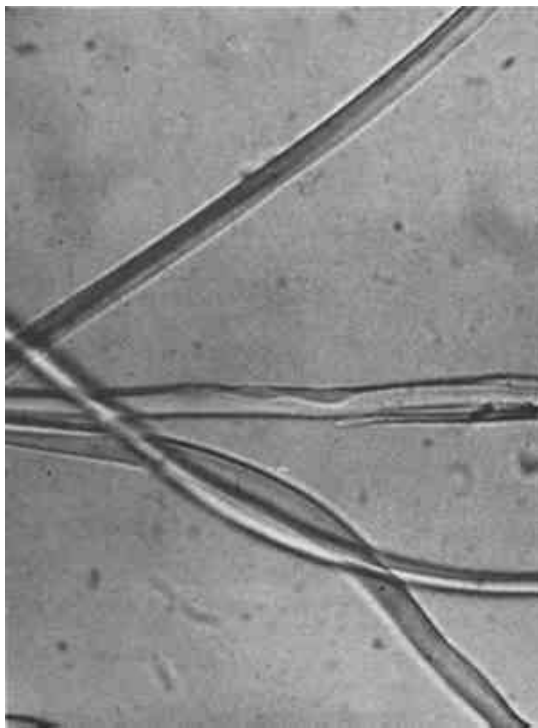


Obr. 2-28. Reaktívne miesta bočných reťazcov aminokyselín v keratine vlny

Vysoký obsah sirných aminokyselín v keratínu vede při jeho pyrolýze ke vzniku zápachajících sloučenin na bázi merkaptanů

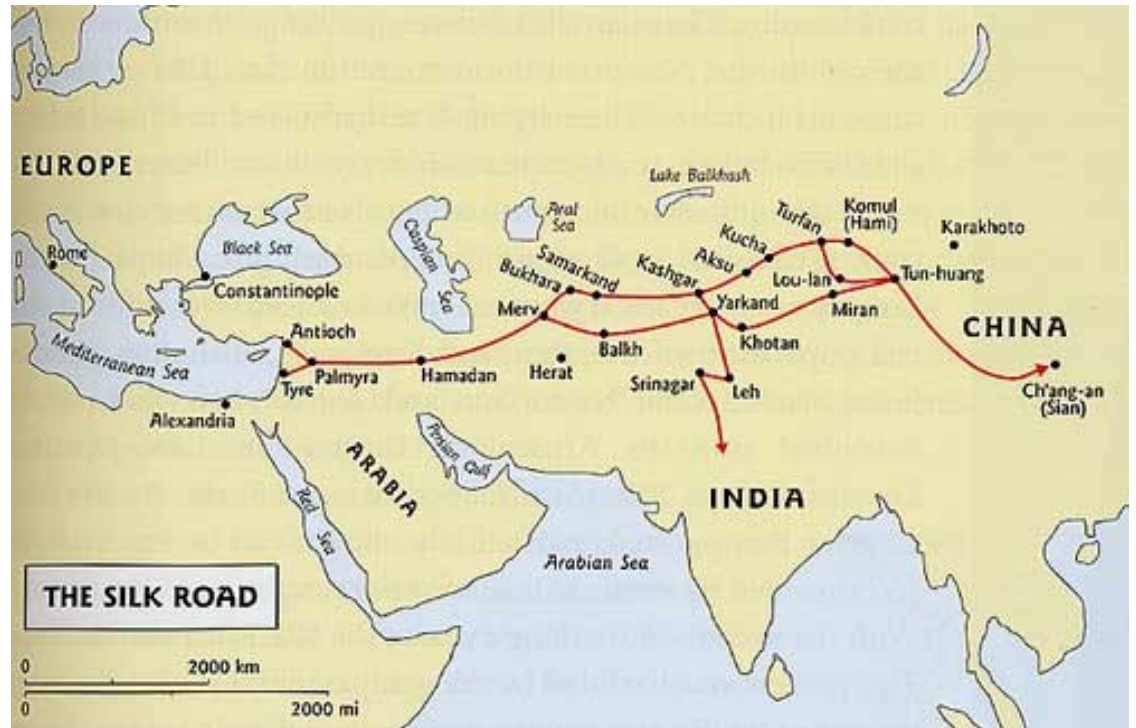
Hedvábí

- Hedvábník (bourec morušový, *Bombyx mori*)
- kokony (zámotky)
- **odklížená** vlákna (zbavená sericinu)

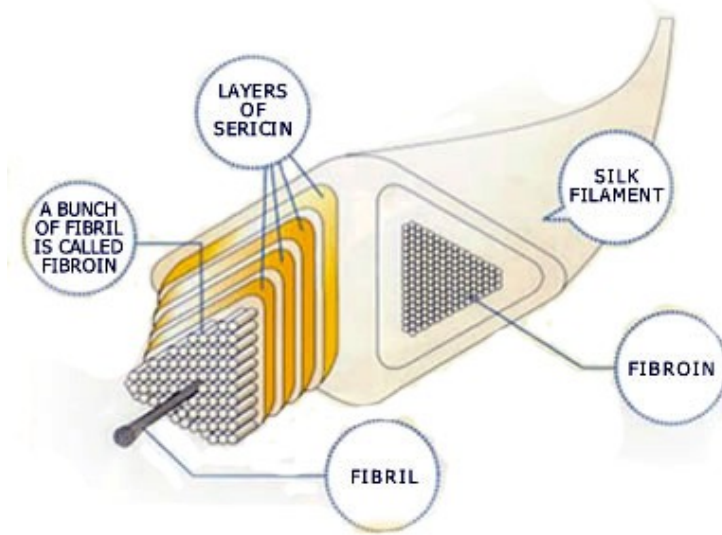


Hedvábí

výchozí surovina pro atlasové, brokátové a vlasové typy tkanin (samet, koberce)



Struktura hedvábí



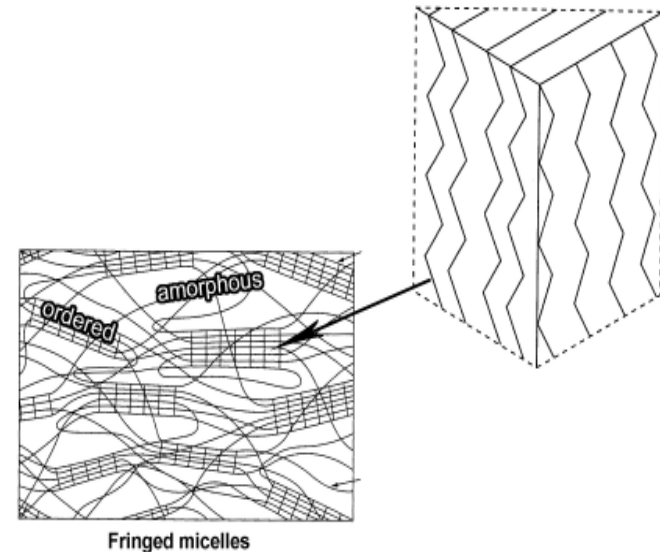
Tabuľka 11.1. Aminokyselinové zloženie (%) fibroínu niektorých druhov prírodného hodvábu (Hearle 1966, Keil a Šormová 1959)

Aminokyselina	<i>Bombyx mori</i>	Tussah <i>Caligula</i>	Tussah II	<i>Anaphe</i>	<i>Chrysopa flava</i>
Glycín	43,58	23,6	23,9	41,7	23,5
Alanín	29,6	39,4	47,2	52,1	50,2
Serín	11,67	10,47	14,80		40,7
Kyselina asparágová	1,35	4,2	7,5		3,0
Kyselina glutámová			1,46		
Tyrozín	4,79	4,35	10,6		
Histidín	0,44	2,23	1,55		
Arginín	1,73	9,23	5,41	2,1	1,8
Prolín	0,39	0,28	0,43		
Tryptofán	0,38	1,99	2,74		
Lyzín			0,17		
Leucín a izoleucín			1,27		
Fenylalanín			1,06		
Treonín			0,2		

Proteiny hedvábí

- fibroin (76%) - z 15 rôznych aminokyselinových reťazcú spojených do formy skládaných listů. V krystalinných segmentech hedvábí se tyto listy objevují v pravidelném trojrozměrném uspořádání.

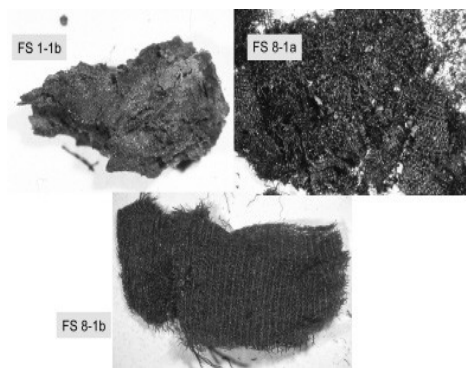
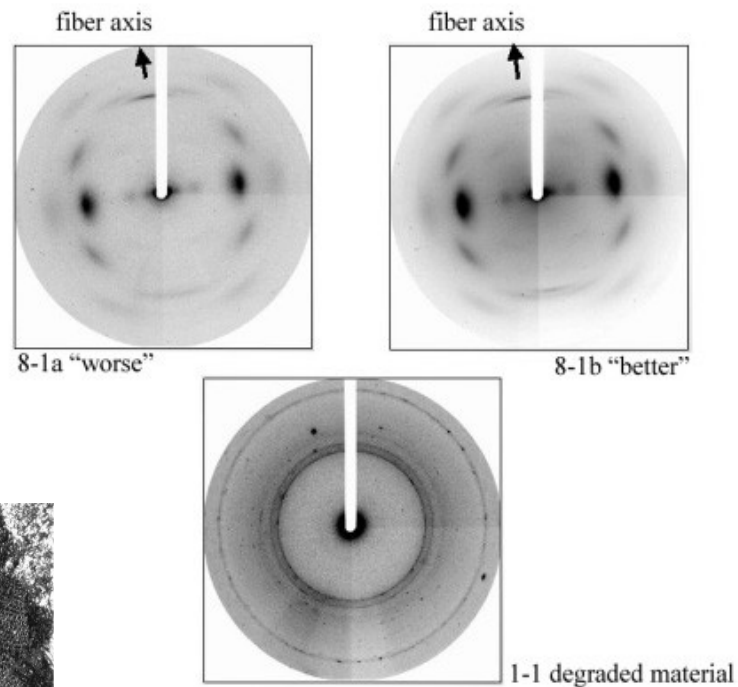
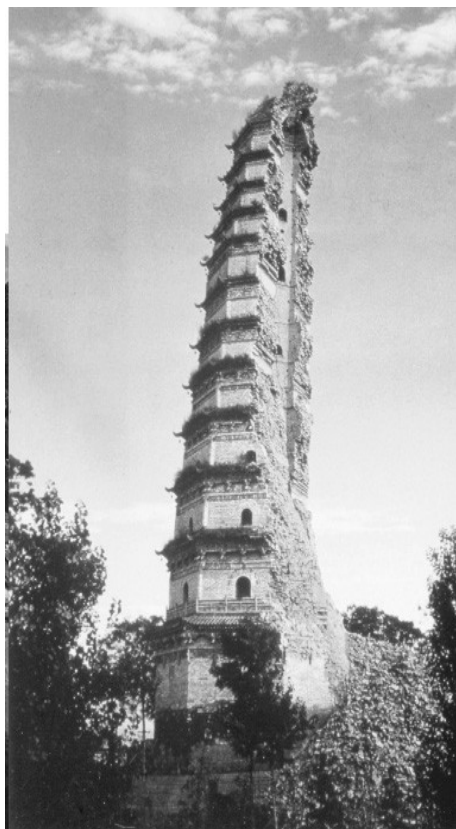
- sericin (22%) – glycin,alanin,tyrosin,leucin.



Zřícená pagoda chrámu Famen nedaleko Xianu (Shaanxi , SZ Čína)

Dynastie Tang (ad 618–907)

Rtg difrakce



Degradované zbytky obsahovaly vyšší podíl krystalinní struktury

Vazba proteinů na montmorillonit

Proteiny fixované na jílovité minerály vykazují vyšší stabilitu vůči saprofytním mikroorganismům

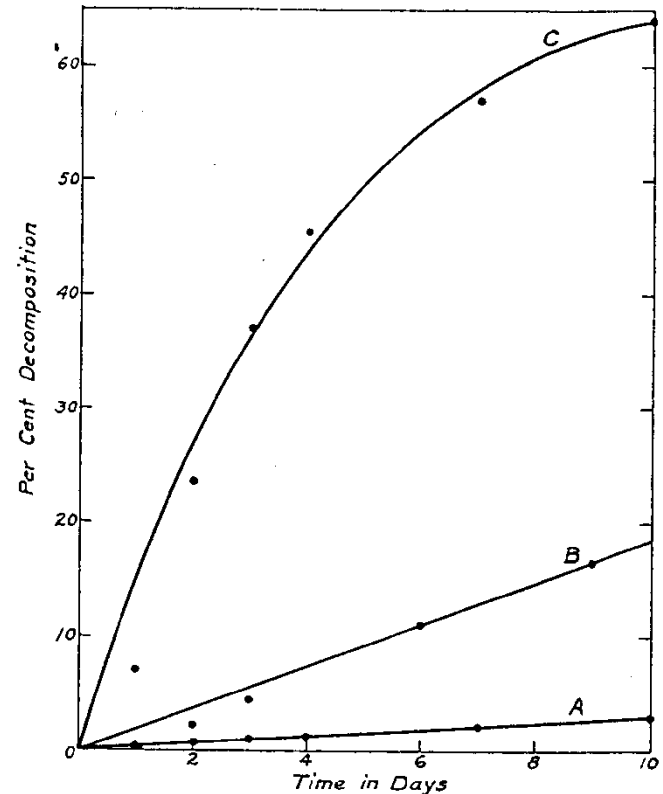
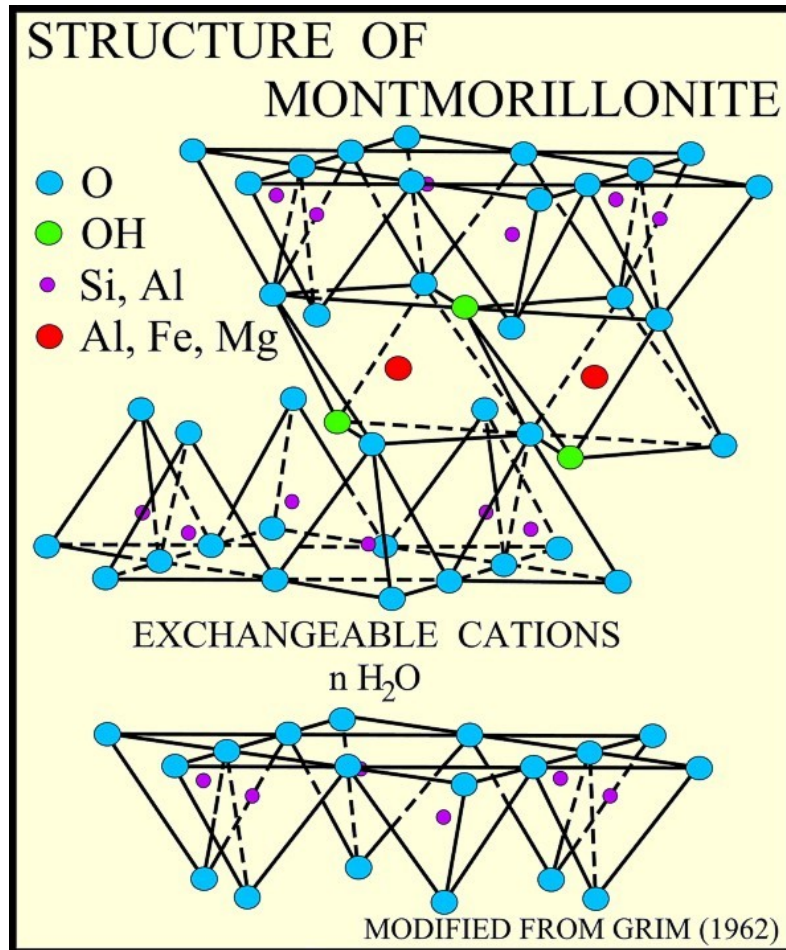


FIG. 1. Decomposition of gelatin by soil microorganisms: A, gelatin-bentonite complex; B, gelatin-bentonite mixture; C, gelatin alone.

Dekompozice měkkých tkání

Biogenní rozklad, limitující faktory:

- 1) množství kyslíku (O_2)
- 2) přítomnost vody
- 3) přítomnost mikroorganismů (bakterie, plísně)

Fáze rozkladu:

Fermentativní autolýza

Emfyzém (bakterie)

Ztráta tekutin

Suchý rozklad (plísně)

Skeletizace

Mikrobiální rozklad těla



Emfyzém



Suchý rozklad



Fermentativní autolýza



Ztráta tekutin



Skeletizace

Experimentální tafonomie

Toxikolog M. Orfila srovnával rychlost rozkladu lidského stehna v různých typech půd (různého složení)

TRAITE DES EXHUMATIONS JURIDIQUES,

ORPHALUS DE M. MATHIEU ORFILA

PAR M. ORFILA,

Docteur et Lecteur d'Anatomie à l'École de Médecine de Paris, et Directeur de l'Hôpital de la Charité.

ORFILA M. D. ABOGADO,

Abogado de Mérito en España, y Abogado de Honor en Portugal.

TRADEMAN OF THE FACULTY, BETHLEHEM COLLEGE.

TOME SECOND.

PARIS,

DEBITEUR AU PUBLISSEUR, M. LAURENT, Libraire de la Faculté de Médecine, et de l'Hôtel de Clugny, n. 10.

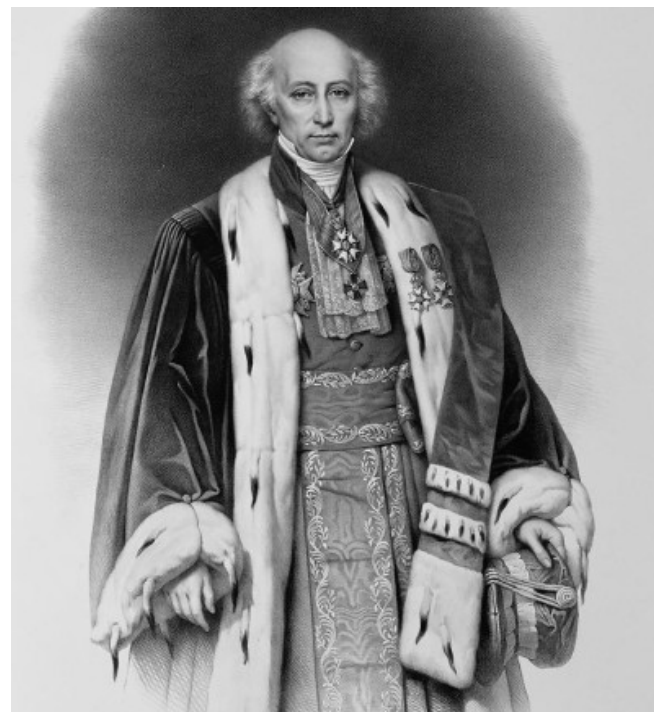
MDCCCXXII.

ce volume se vend séparément, et se trouve chez le même Libraire, et chez les autres Libraires.

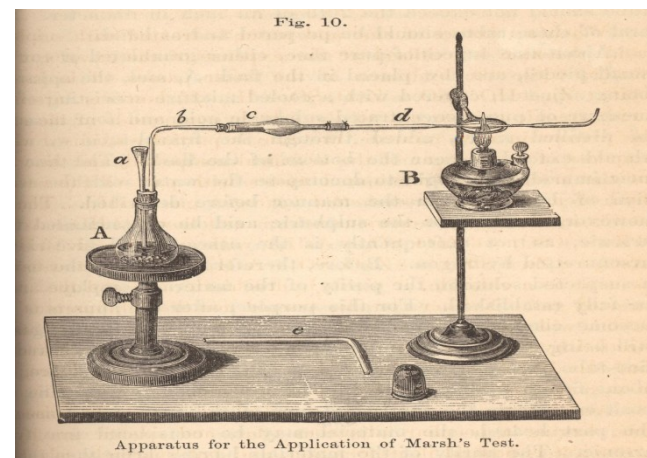
chez LAURENT,

Libraire de la Faculté de Médecine, et de l'Hôtel de Clugny, n. 10.

M.D.



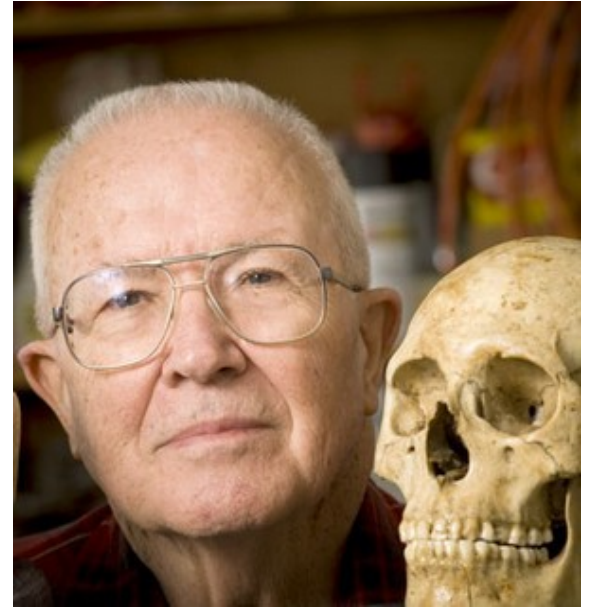
Mathieu J. B. Orfila (1787 – 1853)



„Body farm“

Knoxville, Tennessee

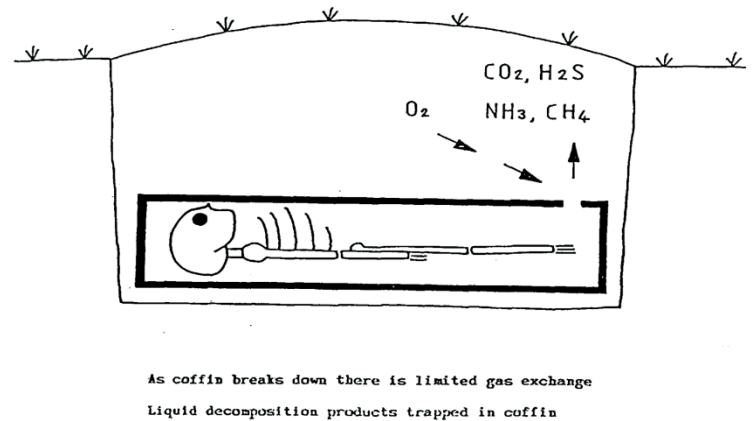
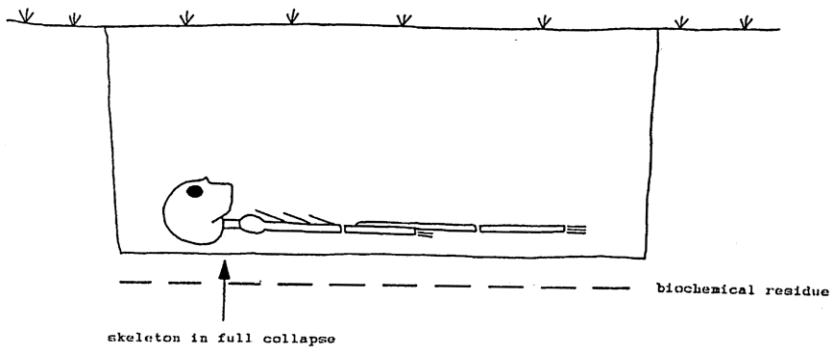
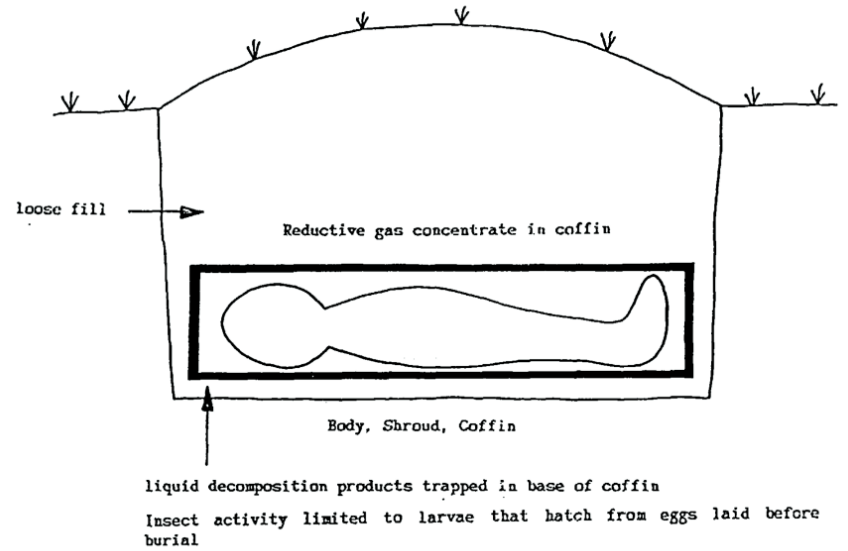
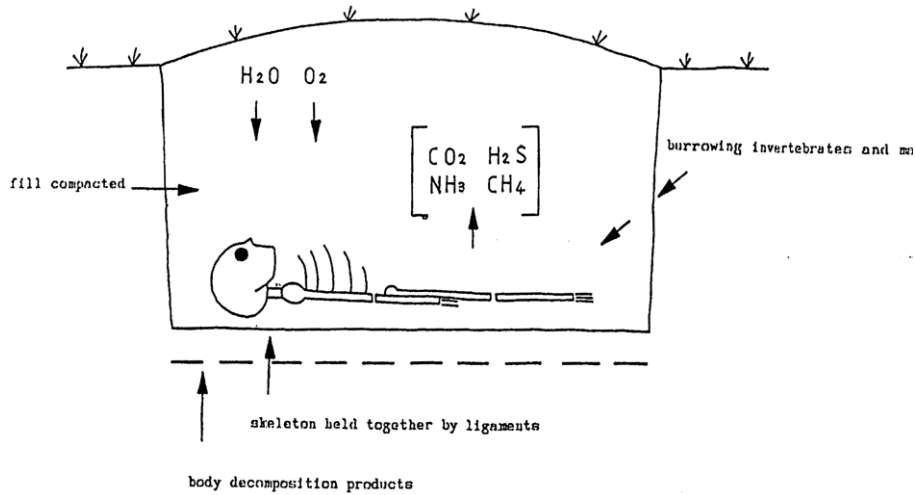
University of Tennessee Anthropological
Research Facility



William M. Bass

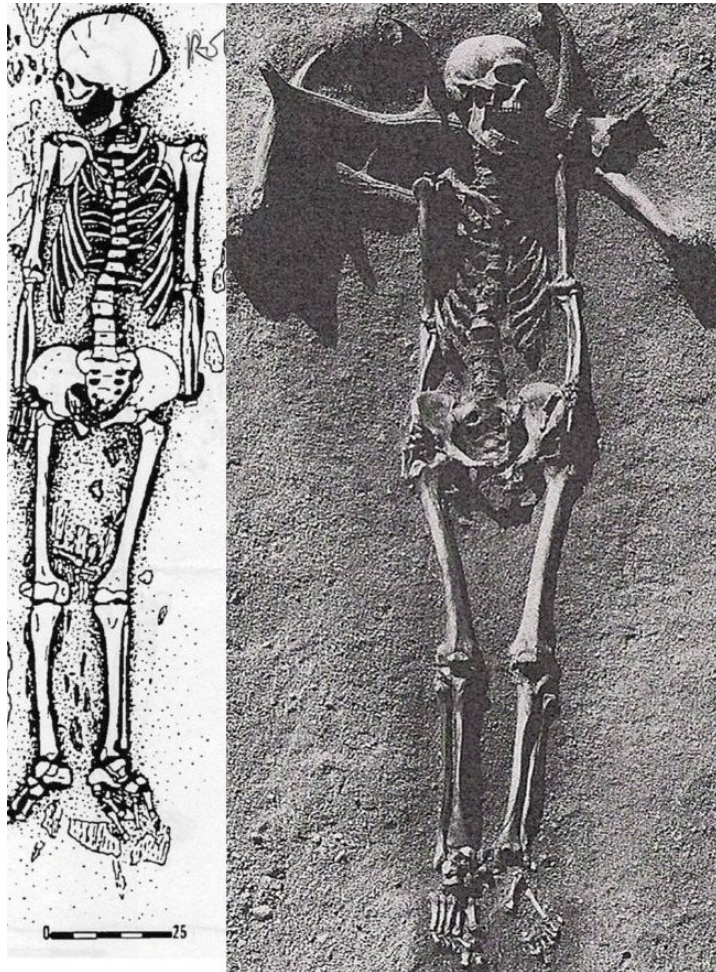


Rozklad v rakvi a bez rakve



Disartikulace kloubních spojení

bez rakve



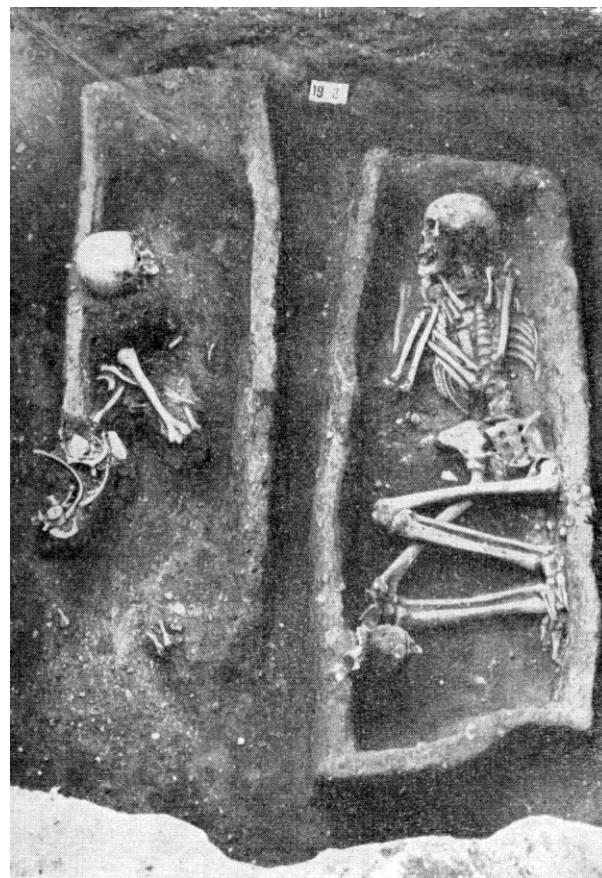
v rakvi



“effet de parois”



Pavlov Horní pole (KZP)



Rebešovice (UK)

Proteiny

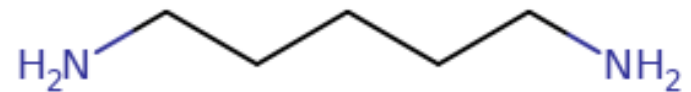
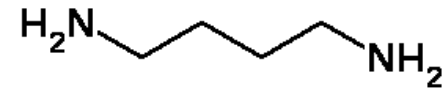
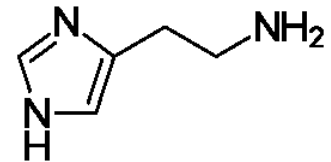
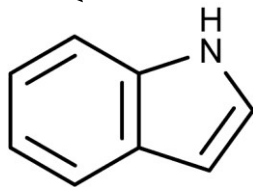
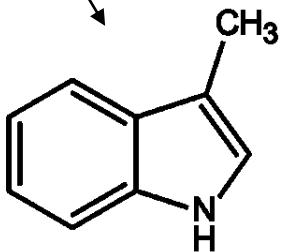
Mikrobiální rozklad:

Hydrolýza proteinů: peptidy, peptony, aminokyseliny

Deaminace aminokyselin: amoniak + organické kyseliny (VFA)

Ptomainy: kadaverin, putrescin, histamin

Skatol, indol



Těkavé organické kyseliny

Mikrobiální rozklad a deaminace proteinů

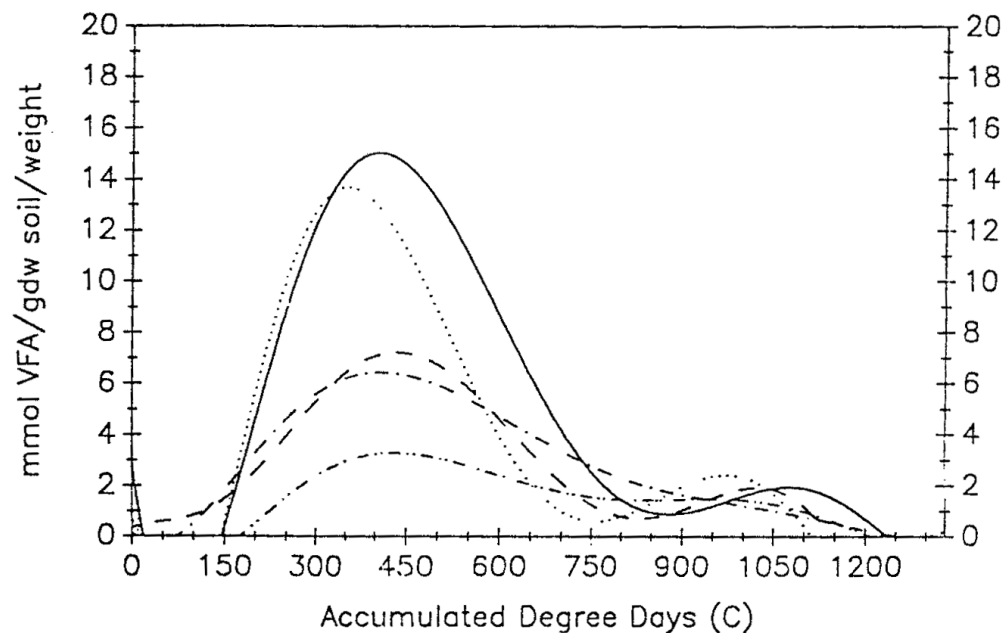


FIG. 1—Ratios of volatile fatty acids, over time, in soil solution underneath a decomposing corpse. Propionic (—), iso-butyric (— — —), n-butyric (·····), iso-valeric (— · —), n-valeric (· · — · ·). Results are best fit regression models.

ug/g	izomáselná	valerová	izovalerová
Duz	412	159	-
Knin	-	-	11,5
Knin	9,3	-	7,3

Hřbitov v Duzu (Kosovo) a hromadný hrob v Kninu (Chorvatsko).

Působení plísní

- změny histologické struktury (krátery, tunely) – plísně i bakterie
- červenofialové změny na kostech (možnost záměny za krev či barvivo)
- rekrystalizace kostního minerálu v důsledku změny pH
- fluorescence kostí v UV světle (metabolické produkty plísní – tetracykliny mají vysokou afinitu ke kosti – vznik komplexů a chelátů)

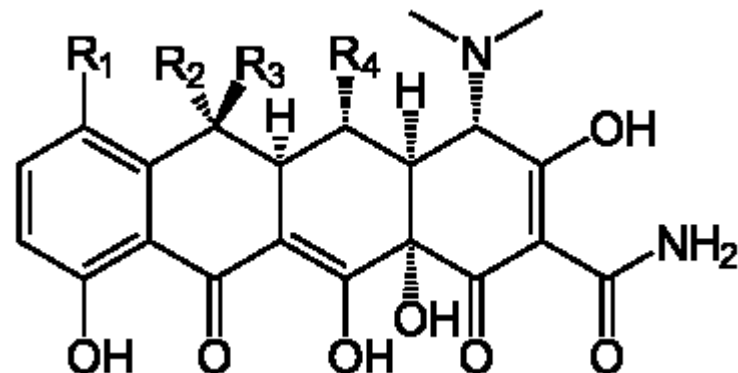


Tetracykliny se používají jako léčiva a ke sledování růstu kostní tkáně. Při dlouhodobějším užívání zanechávají typické zbarvení zubů.

Tetracykliny

Antibiotika (od konce 40. let)

Produkty metabolismu plísňí a
mycet (např. Streptomycety)



Fluorescence v UV světle

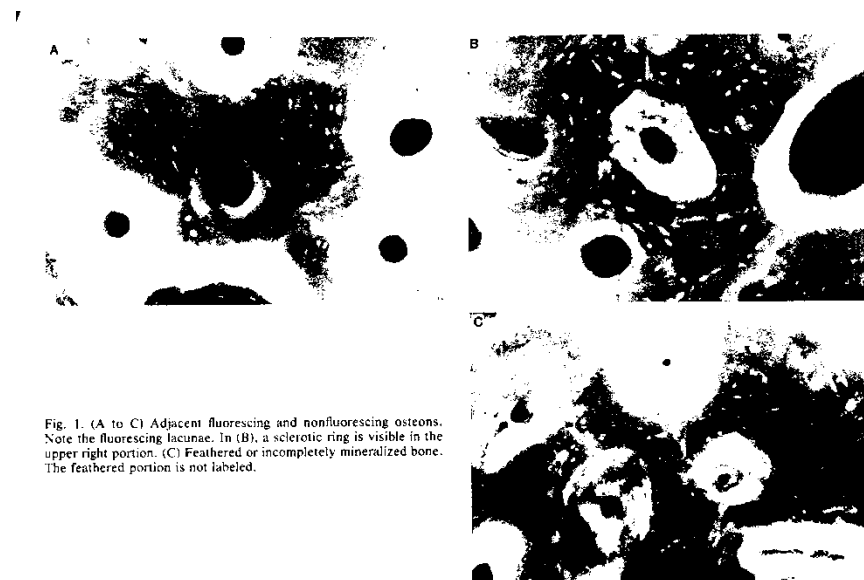


Fig. 1. (A to C) Adjacent fluorescing and nonfluorescing osteons. Note the fluorescing lacunae. In (B), a sclerotic ring is visible in the upper right portion. (C) Feathered or incompletely mineralized bone. The feathered portion is not labeled.

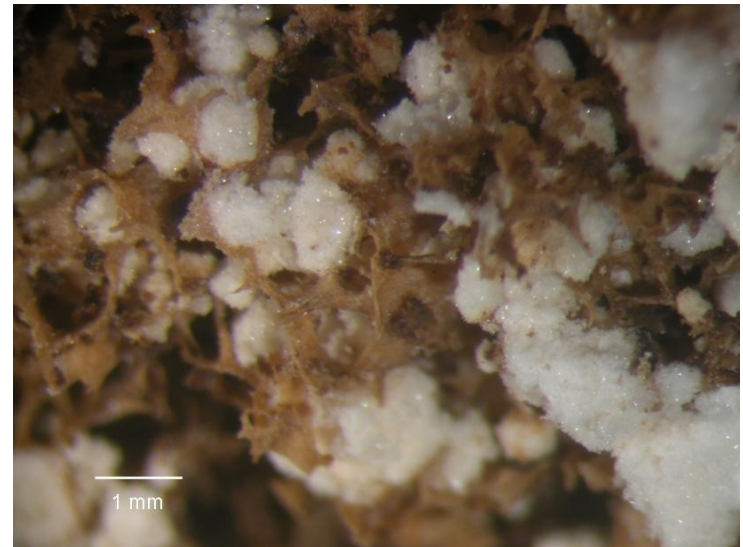
Transformace kostního minerálu

V kyselém prostředí:

hydroxyapatit ($\text{Ca}_{10}(\text{PO}_4)_6(\text{OH})_2$) \rightarrow *brushit* ($\text{CaHPO}_4 \cdot 2 \text{H}_2\text{O}$)

pH: 7,0 – 7,5 (fyziologické)

pH: 4,5 – 6,0



Kyjov

Hrob H 1034

pohřeb je narušen v místech,
kde se nacházely hlavy a trupy
pohřbených jedinců

dolní končetiny jsou v obou
případech sekundárním
zásahem prakticky
neporušené








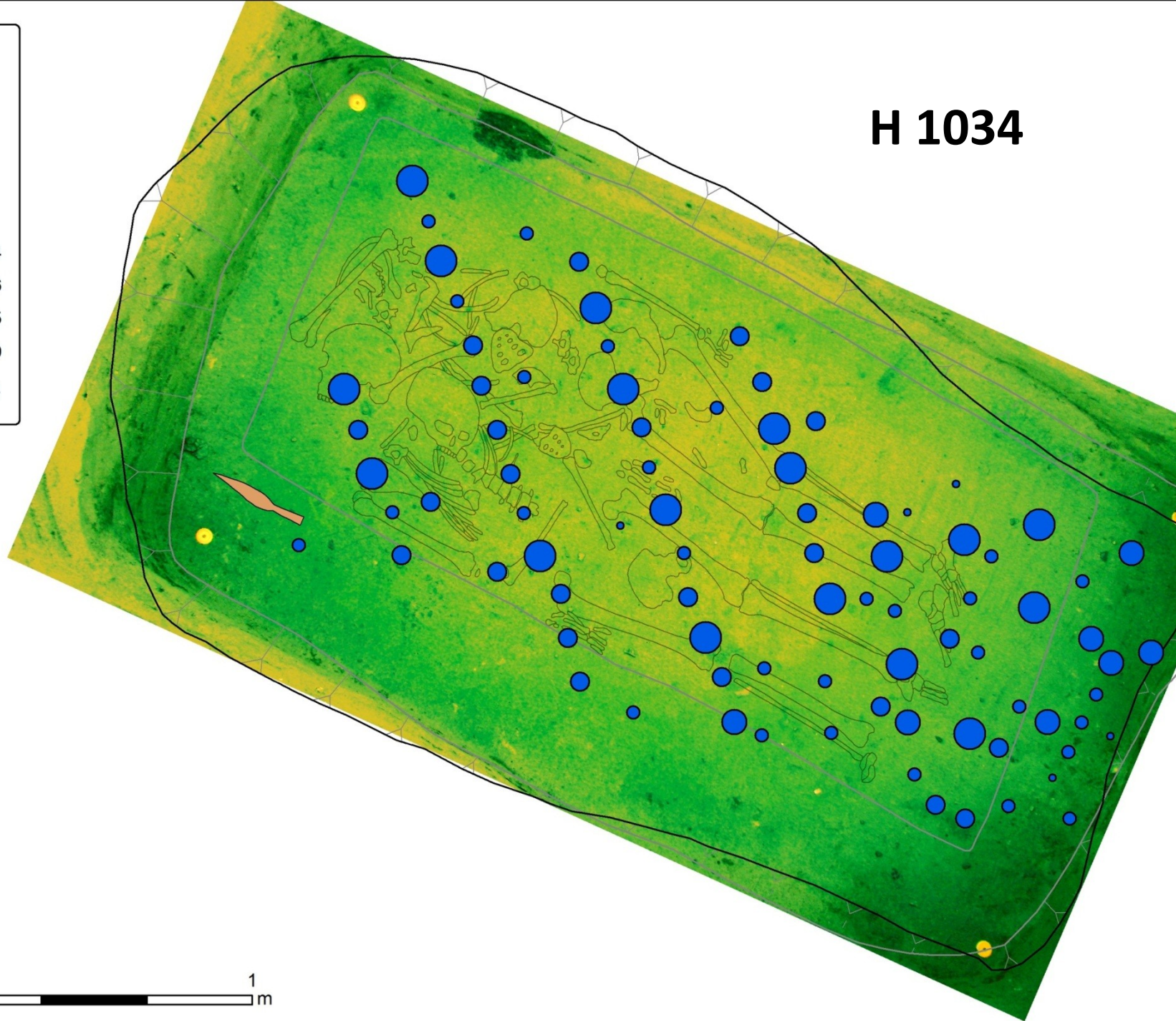
H 1034

-  Horní hrana
-  Dolní hrana
-  Hrot kopí
-  Kost

Fosfát

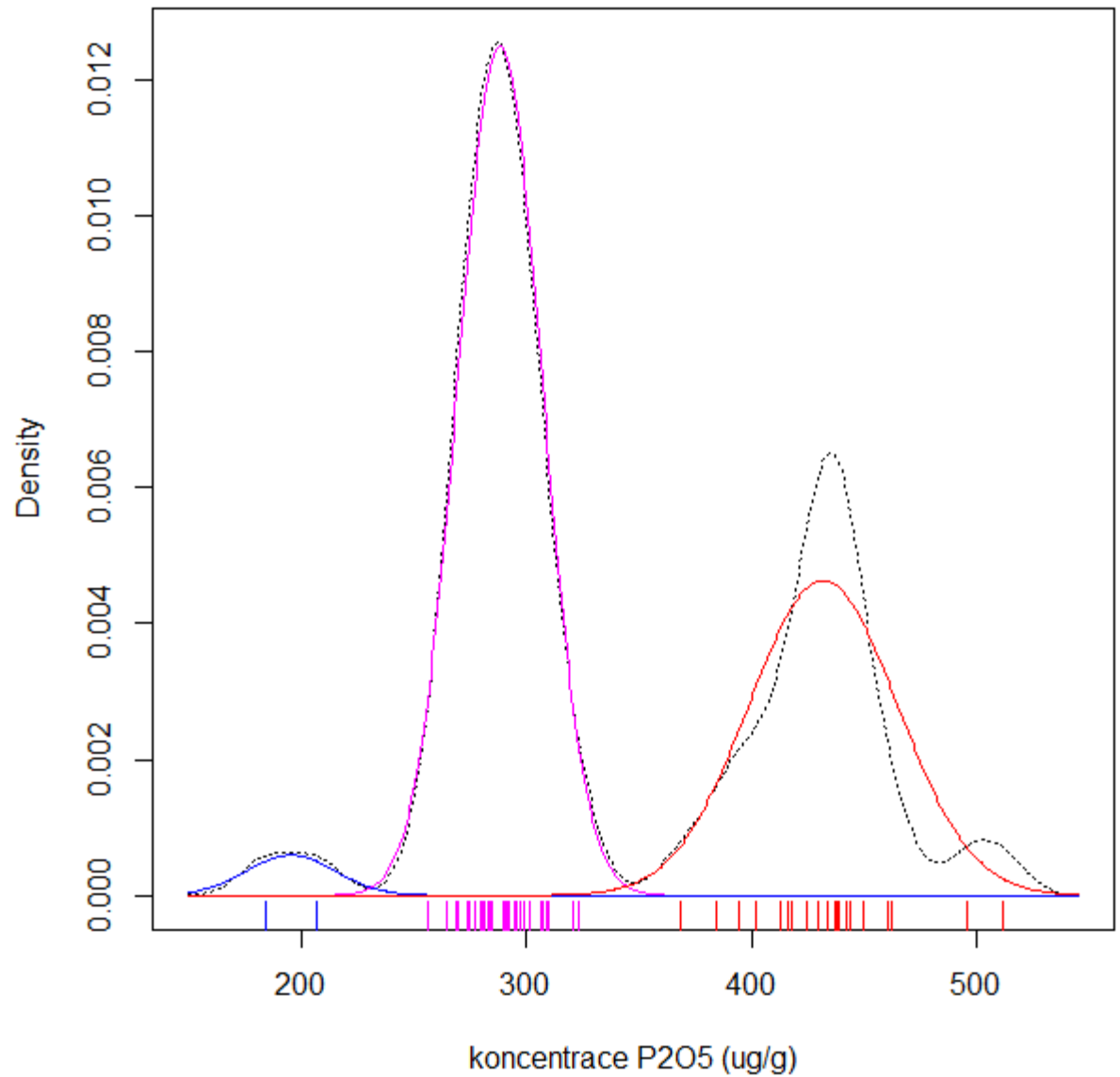
ppm X 100

-  1,837 - 2,304
-  2,305 - 2,846
-  2,847 - 3,235
-  3,236 - 4,179
-  4,180 - 5,114

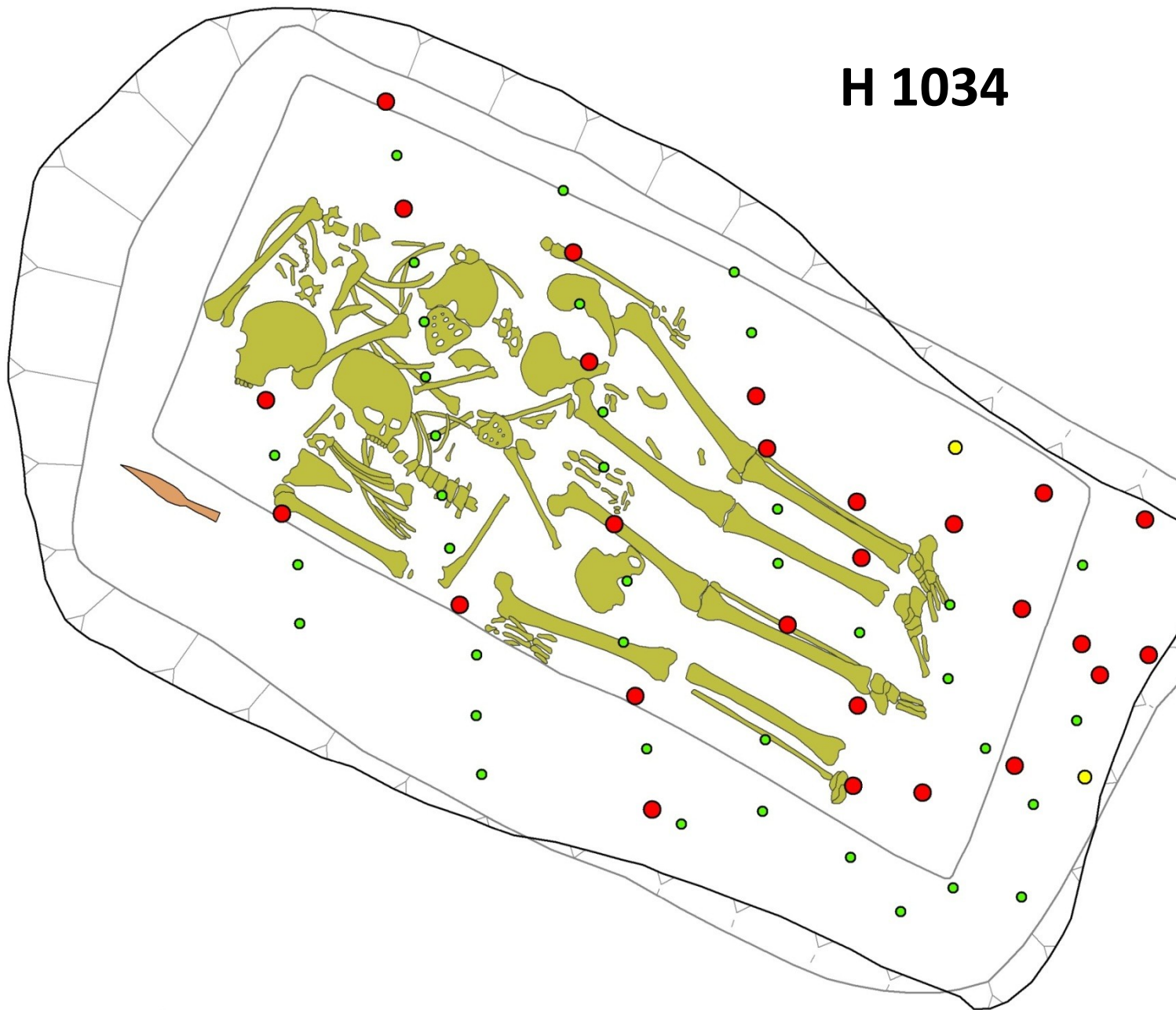


Kyjov, H 1034

Rozklad distribuce na
gaussovské složky
metodou maximální
věrohodnosti



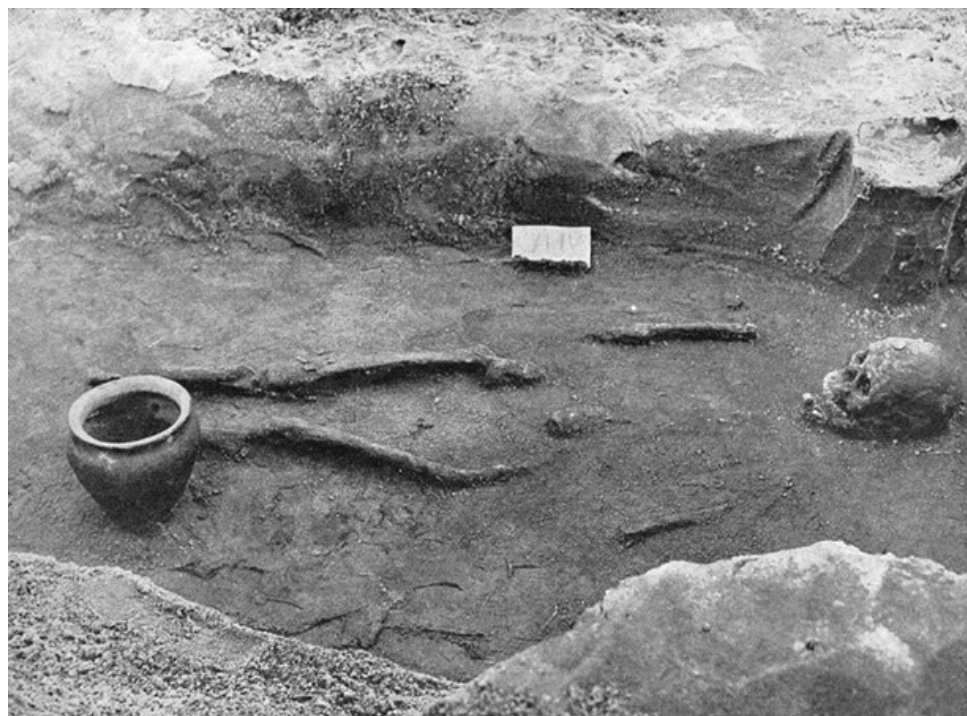
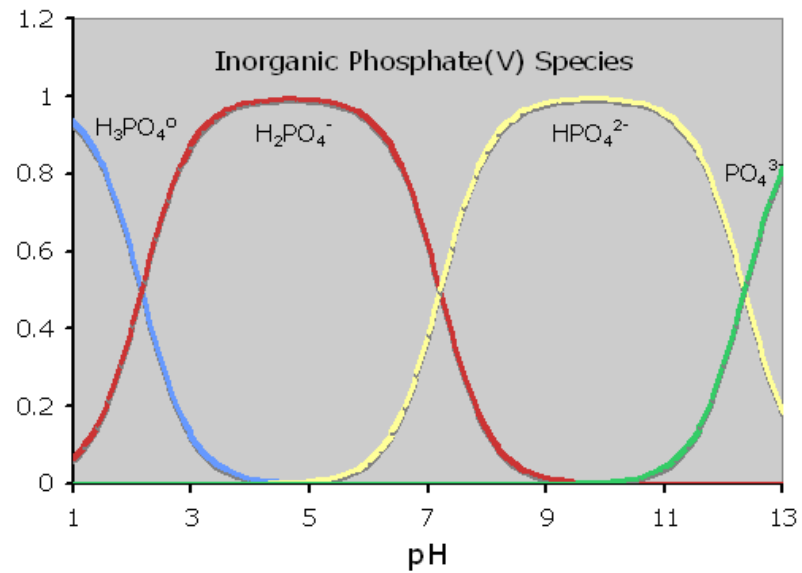
H 1034



	Horní hrana
	Dolní hrana
	Hrot kopí
	Kost
Fosfát	
shluk	
	1
	2
	3



Rozklad kosterních pozůstatků

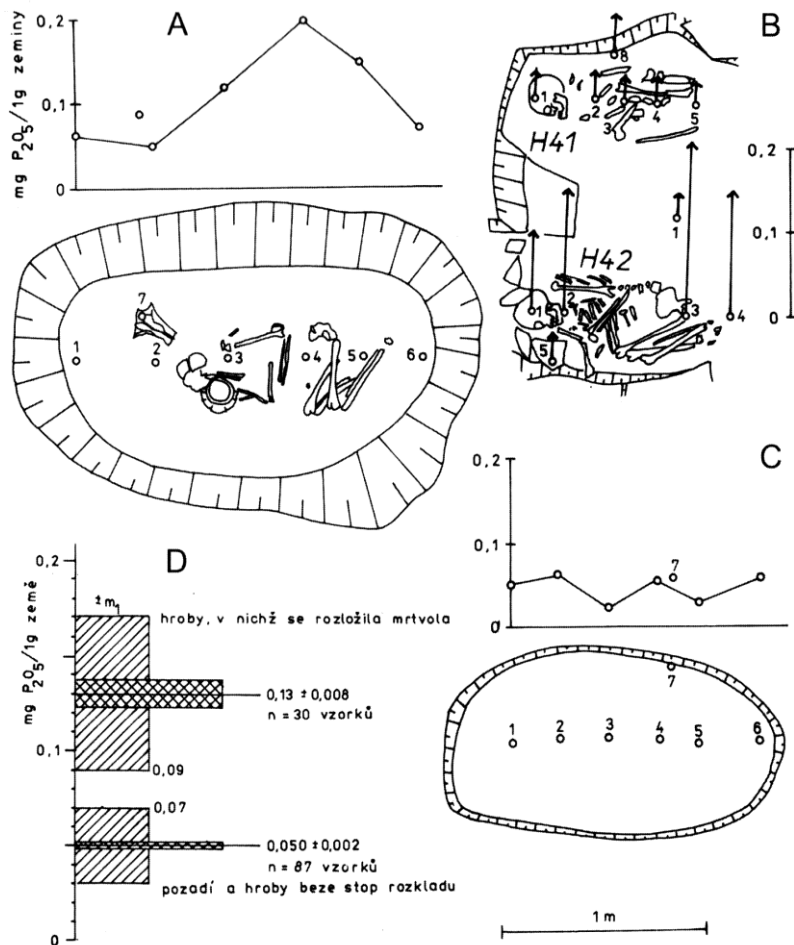


Totální rozklad skeletu

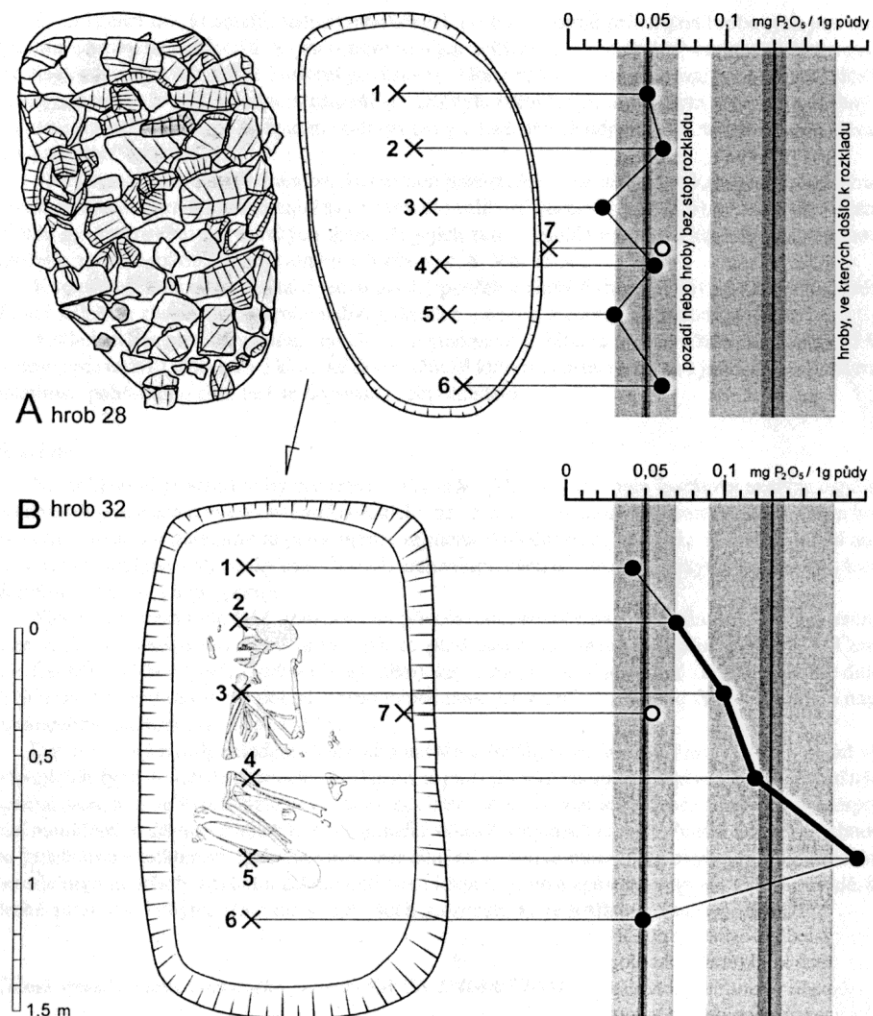
Mechanismem rozkladu je přeměna hydroxyapatit → brushit, rekrystalizace vede k mechanickému rozrušení kostního minerálu a následnému vzniku „siluety“, či totálnímu rozkladu skeletu (k dokumentaci silně nebo zcela rozložených skeletů je vhodné využít fotografii v UV oblasti). Přeměna může být indukována:

1. **nízkým pH půdy** (< 7; kyselé půdy, vysoký obsah huminových kyselin)
2. **kyselými metabolity saprofytních mikroorganismů** (např. kys. citronová, šťavelová, aj.), napadajících buď tělo (zejm. plísně, v menší míře bakterie), nebo materiál rakve (dřevokazné houby). Uplatňuje se např. v hrobech v alkalických půdách a v kryptách. Charakteristickým projevem biogenního rozkladu je významný rozdíl v zachovalosti jednotlivých částí skeletu.

Praha – Miškovice

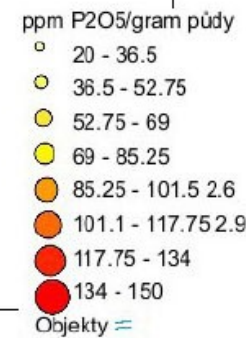
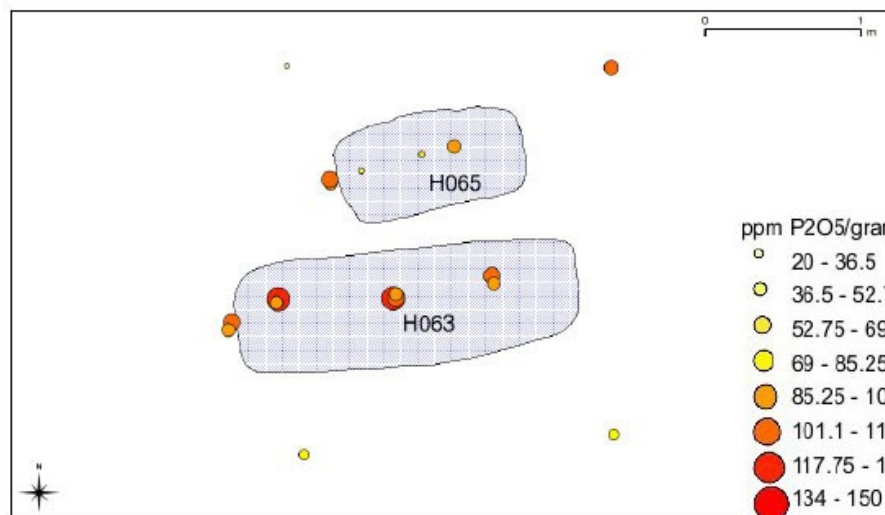
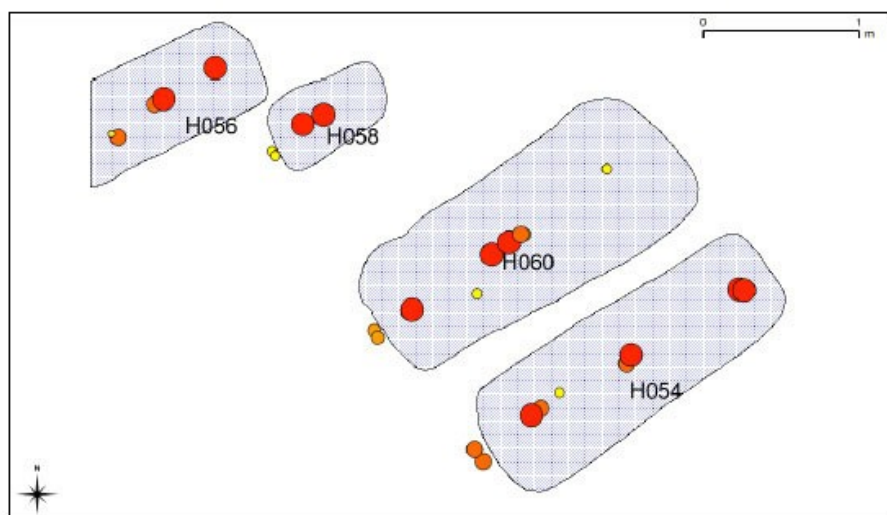
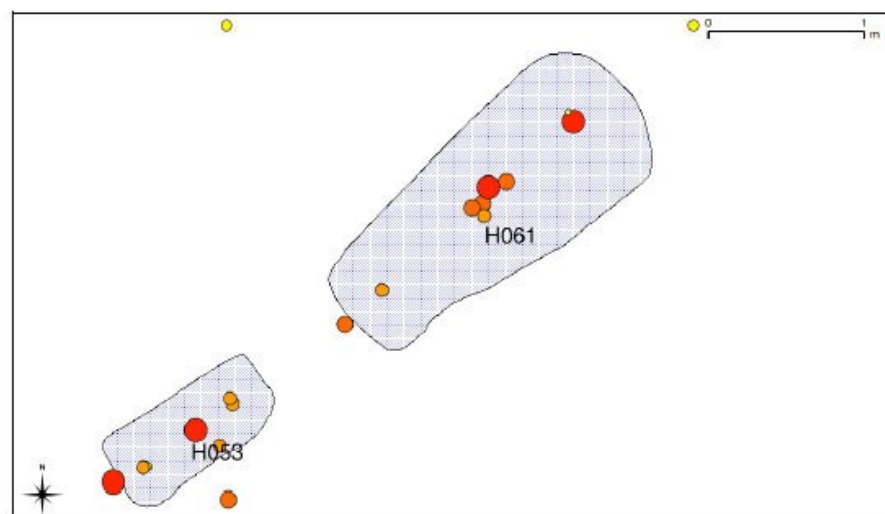
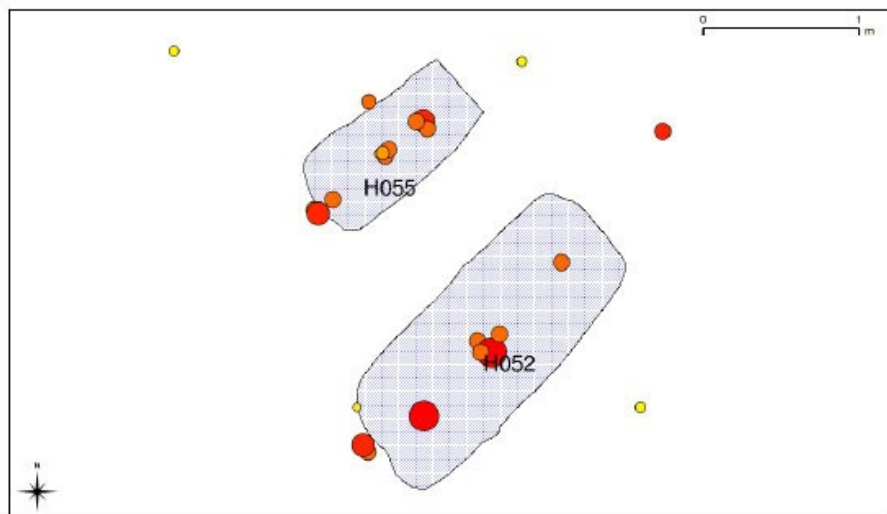


Obr. 6.16. Praha 9-Miškovice, výzkum M. Ernée (Archaia Praha). Hroby únětické kultury. A: Křivka hodnot v hrobě, kde došlo k rozkladu těla. B: Hrob s pohřby H41 (bez fosfátové anomálie) a H42 (s fosfátovou anomálií). C: Hrob bez fosfátové anomálie (k rozkladu těla došlo jinde). D: Vyhodnocení hodnot obsahu fosforu pomocí statistické metody nejmenších čtverců (viz text). Měřil A. Majer.



Obr. 5. Praha 9 – Miškovice. Výsledky fosfátové analýzy v hrobech 28 (A – nahoře) a 32 (B – dole). Křížky jsou označena místa odběru vzorků.

Pohansko u Břeclavi



Postdepoziciční změny proteinů

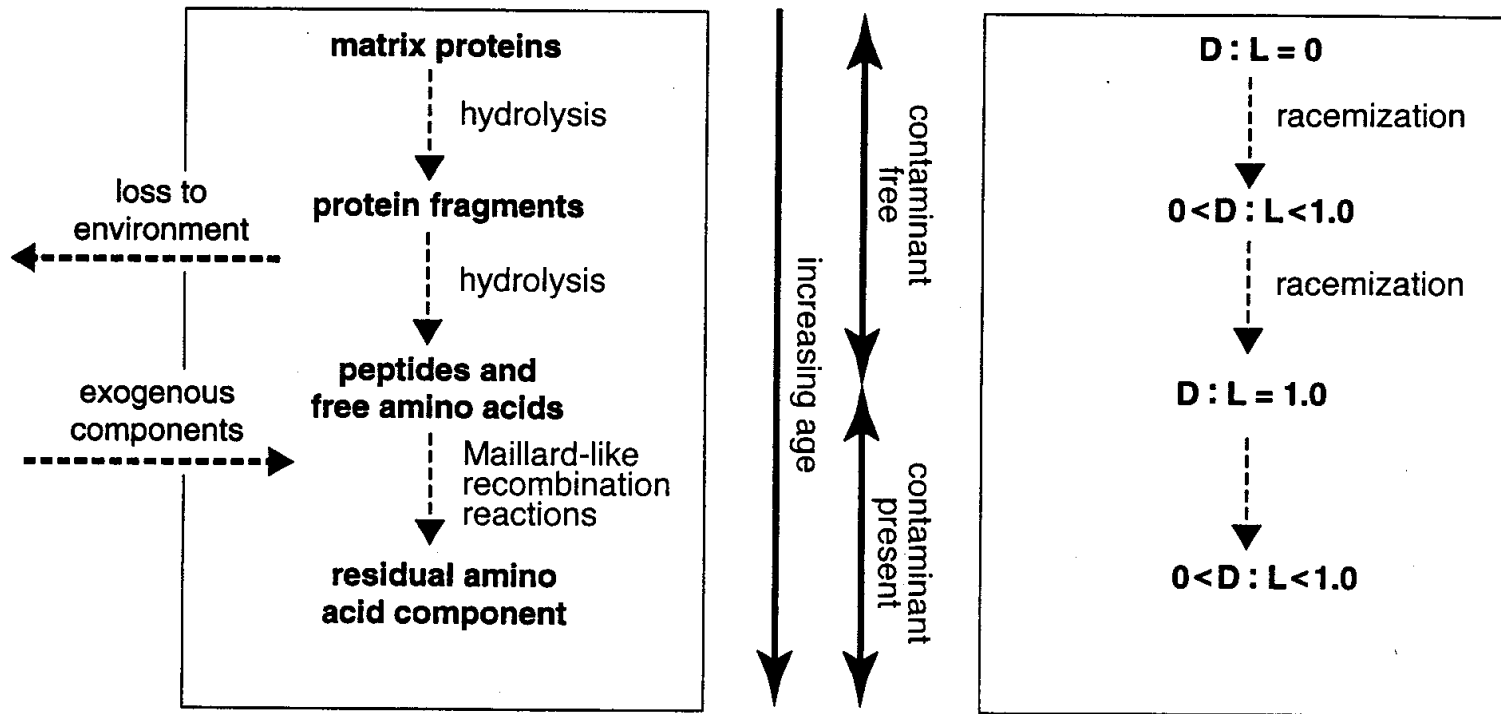


Figure 3. A model showing the diagenesis of the proteins and their constituent amino acids in the fossil matrix. As peptide bond hydrolysis takes place (left), the released amino acids can diffuse out of the matrix and are lost to the environment over geological time. Exogenous components can enter the fossil matrix and may react with remnant endogenous amino acids to form geopolymeric material similar to humic acids. The original L-amino acids present in the specimen undergo racemization (right), following a defined pattern of racemization rates ($D:L \text{ Asp} > D:L \text{ Ala} > D:L \text{ Val}$). Racemization should be complete in $< 1-5$ million years in most environments on the Earth. The addition of contaminants would lower and distort the expected extent and pattern of racemization for the various amino acids.

Kontaminace

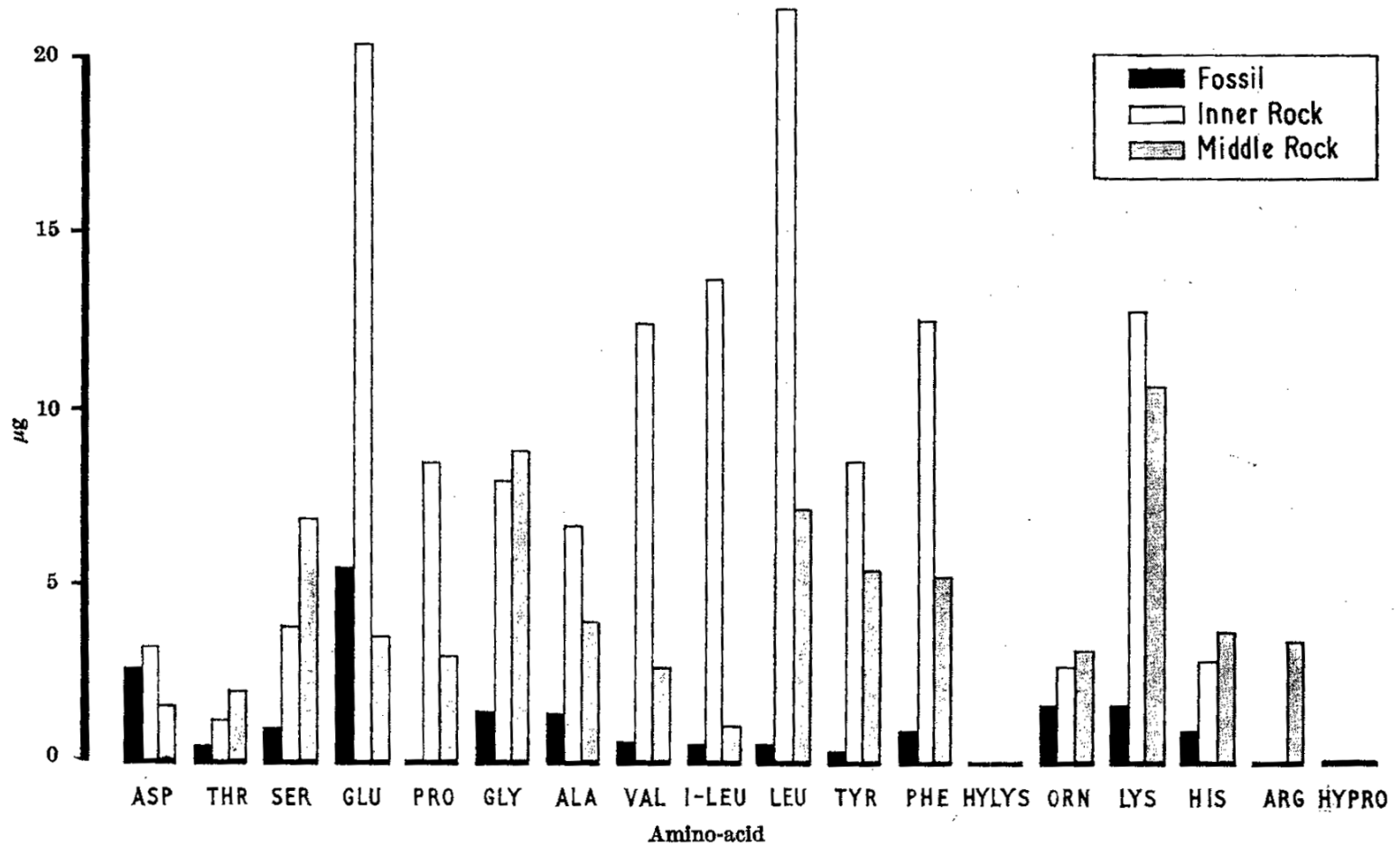


Fig. 2. Amino-acid per 5 g fossil or rock sample

Hydrolýza

Voda
Kyseliny
Báze
Enzymy

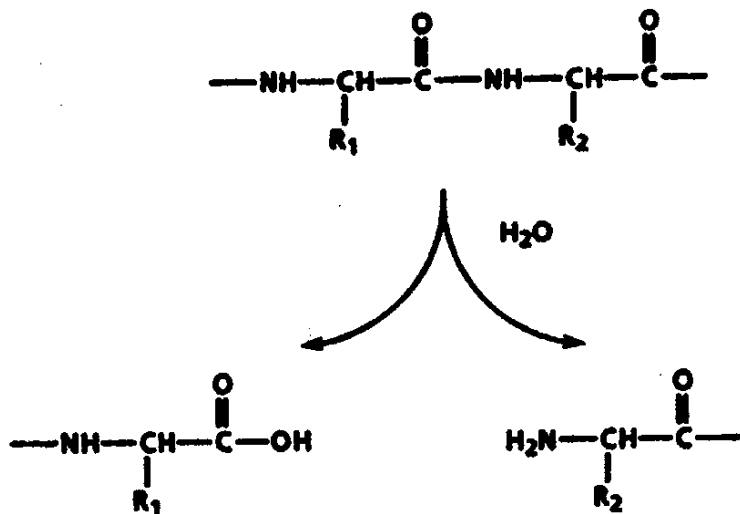
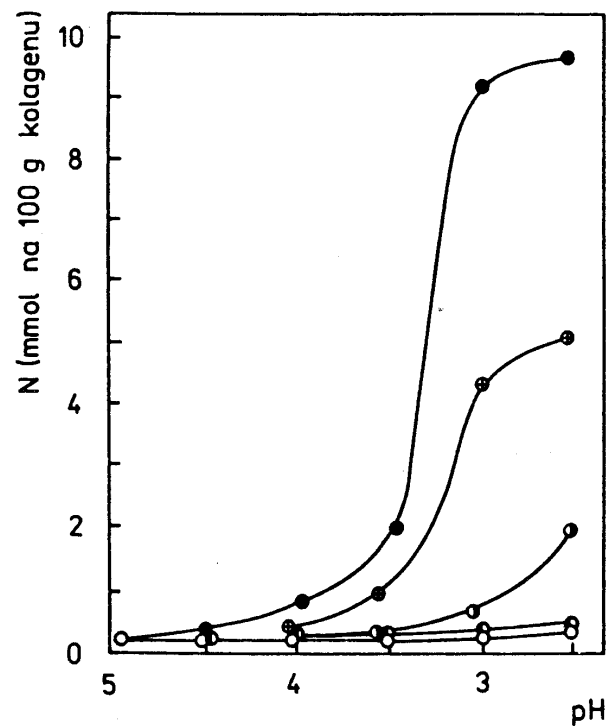


Fig. 13. Hydrolysis of the peptide backbone.



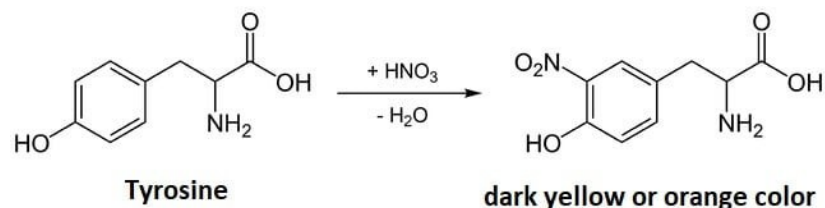
Závislost koncentrace koncových, dusík obsahujících skupin N (indikujících stupeň hydrolytické degradace) na pH usně uložené v prostředí o různé poměrné vlhkosti při teplotě 40 °C po dobu 8 týdnů¹⁴. ● 100 % poměrné vlhkosti, ⊕ 85 % poměrné vlhkosti, ● 75 % poměrné vlhkosti, ● 40 % poměrné vlhkosti, ○ 0 % poměrné vlhkosti.

Vlna

Izoelektrický bod při pH = 4,9 => je stabilní v kyselém prostředí

Kyseliny:

Pouze koncentrované kyseliny, zředěné se vážou na bazické skupiny. S HNO₃ poskytuje xanthoproteinovou reakci (vznik žlutého zbarvení).



Boční řetězce jsou stálé, s výjimkou Trp který se zcela rozkládá. Nejprve se štěpí amidické skupiny, pak následuje celková hydrolýza peptidického řetězce. To se projeví v mechanických vlastnostech vlákna. Citlivost vůči kyselé hydrolýze je zvýšena je-li cystein zoxidován na kyselinu cysteovou. Peptidová vazba sousedící s kyselinou cysteovou je na kyselou hydrolýzu velmi citlivá.

Alkálie:

rozkládají vlnu ve větší míře.

Hedvábí

Hydrolýza peptidových vazeb, nejnižší v oblasti pH 4 až 8

Kyseliny:

Účinnější, napadají celý řetězec, hydrolýza je poměrně rychlá.

Zásady:

Zejména počátku napadají spíše konce řetězce. Odolnější než vlna, hydrolýza spíše za horka.

Enzymy:

ne, hlavní řetězce v hedvábí jsou příliš blízko sebe.

Vroucí voda:

rozklad fibroinu

Hydrolýza nekolagenních proteinů kosti

Kyselina γ -karboxyglutamová (Gla) je specifická pro nekolagenní proteiny

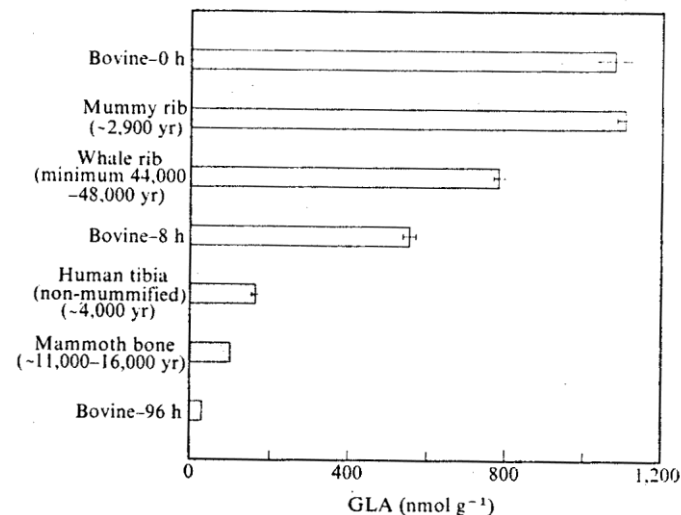
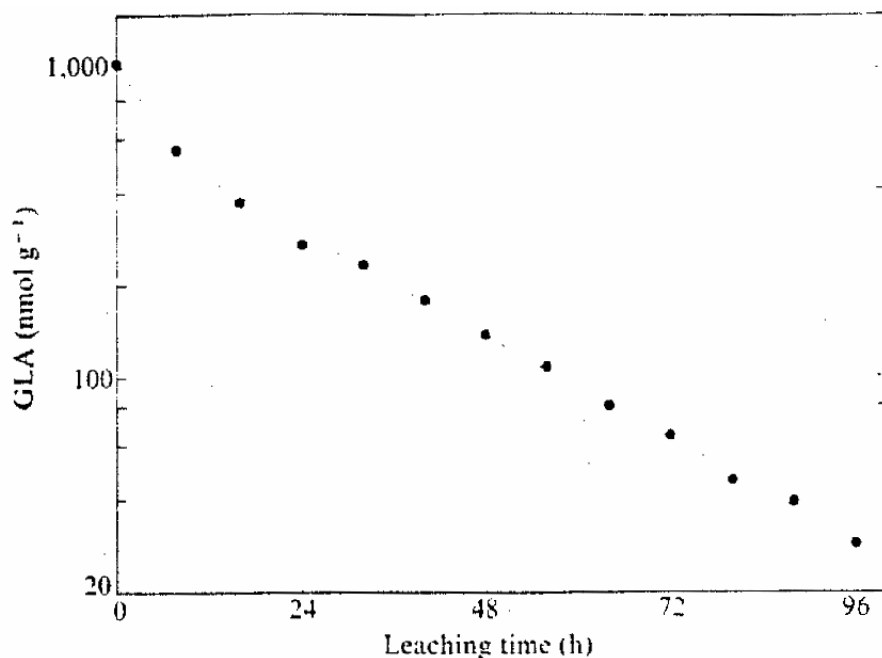


Fig. 2 γ -Carboxyglutamic acid (Gla) concentration in four fossil bone samples. Shaded bars represent the means of duplicate analyses of single fossil samples. Reference values from three artificially leached bovine samples (Fig. 1) are included as open bars. Standard deviations are indicated by lines.

TABLE 2. OSTEOCALCIN DETECTION

Sample	Organism	Age (Ma)	DIBA* RIA	Gla/Glu (ng/ml)
R1	Cow	0	++++	>25 0.012
R2	Horse	0	++++	>25 0.032
R3	Alligator	0	++++	>25 0.026
R4	Chicken	0	++++	>25 0.018
F12.T9	Deer	1	+++	n.d. 0.024
F13.T10	Bovid	1	+++	n.d. 0.046
F14.T8	Bovid	1	+++	n.d. 0.002
F18.56	Horse	3.5	+	n.d. n.d.
F30.52	Turtle	15	+	>20 0.05
F32.17	Titanother	30	-	0 n.d.
F33.12	Ceratopsian	75?	++	52 1.0
F33.46	Ceratopsian	75?	+	28 0.14
F34.CV	Sauropod	150	+	92 0.74
F38.2	Hadrosaur	75.5	++	45 1.0
F38.51	Hadrosaur	75.5	+	>80 0
F39.24	Ceratopsian	73.25	-	1.6 0
F41	Humic acids	0	-	0 0
Merc.	Bivalve	1	-	n.d. 0†
Pachy.	Brachiopod	25	-	n.d. 0†

Note: n.d. = not determined.

*Reaction scoring: ++++ = very strong; +++ = strong; ++ = moderate; + = weak; - = no reaction.

† According to King (1978b).

Obsah dusíku v kostech

Absolutní chronologie

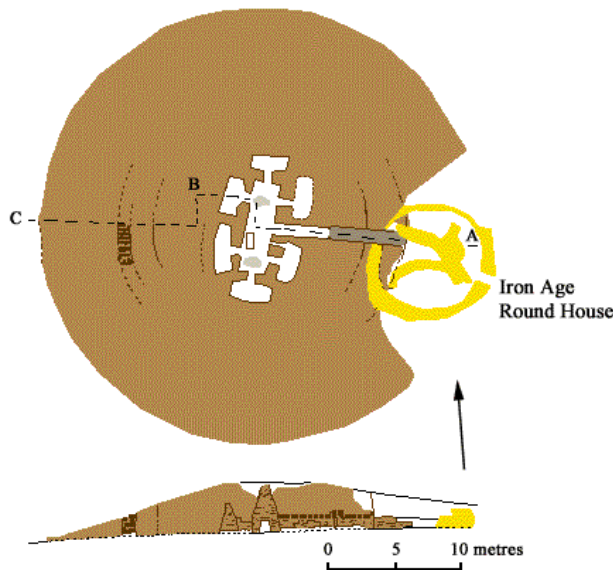
Relativní chronologie

Vliv na obsah dusíku v kosti mají teplota, charakter a propustnost prostředí, pH půdy. + metoda stanovení a příprava vzorku.

Obsah dusíku v kostech téhož skeletu i v různých částech téže kosti se mohou lišit až čtyřnásobně. Je velmi důležité zda se odebírá kompaktní kost, nebo spongioza – ta je citlivější ke kontaminaci i vymývání dusíkatých látek. Vařené kosti vykazují nízký obsah dusíku – vroucí voda vymývá org. Látky. Působením suchého tepla se kolagen štěpí, zůstává však fixován v kosti.

Vymývání kostí může být úzce lokální, závisí na typu kosti.

Obsah dusíku v kostech



Obsah dusíku v neolitických kostech z komorové mohyly z Quanterness (Orkneje). Neolitické stáří pozůstatků bylo potvrzeno 14C.

N (%)	Pes	Člověk A	Člověk C
atlas	3,43		
obratel (neurč.)	3,52		
metakarpus	4,14		
pelvis			1,03
calcaneus	4,09		
humerus		3,0	
radius		1,49	3,89
fibula			1,48

Obsah dusíku v kostech

S Anglie

2 hřbitovy A a LG

(vzdálenost cca 150km)

Jedné podzimní noci 30letý student opustil svou kolej a již se nevrátil. O 14 let později byl na soukromém pozemku cca 1 km od koleje nalezen volně ležící skelet, částečně překrytý vegetací. Kosterní pozůstatky, beze stop po zranění, patřily zmizelému studentovi. Obsah dusíku ve vzorku femuru byl 1,1 g N/100 g kosti (obsah v čerstvé kosti obvykle činí 4 – 5 g N/100 g kosti).

Obsah dusíku v kostech

hydroxyproline = 7482.6 N₂
 glutamic acid = 6227.5 N₂
 arginine = 5103.8 N₂

New Zealand AD 1250 to AD 1932

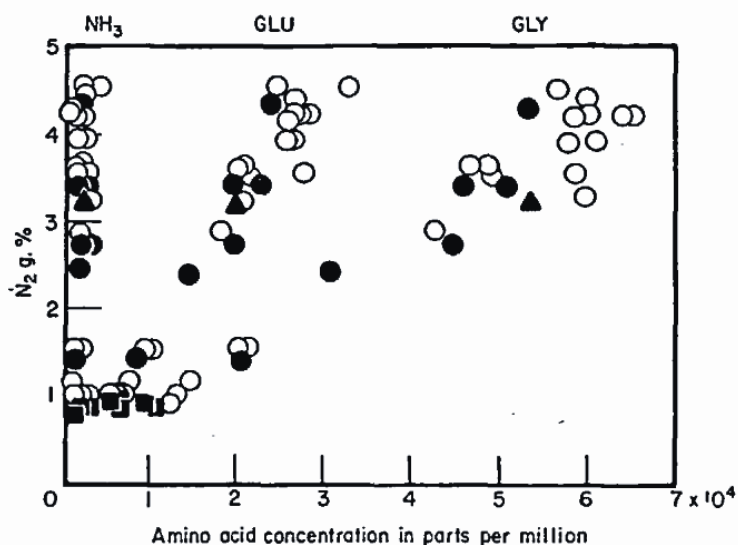


Figure 1. Glycine, glutamic acid and ammonia concentrations related to nitrogen weight percentage in whole bone. Key: ■, calvarium; O, cortical bone (femur, fibula, mandible half, radius, tibia, ulna); ●, rib; ▲, vertebra.

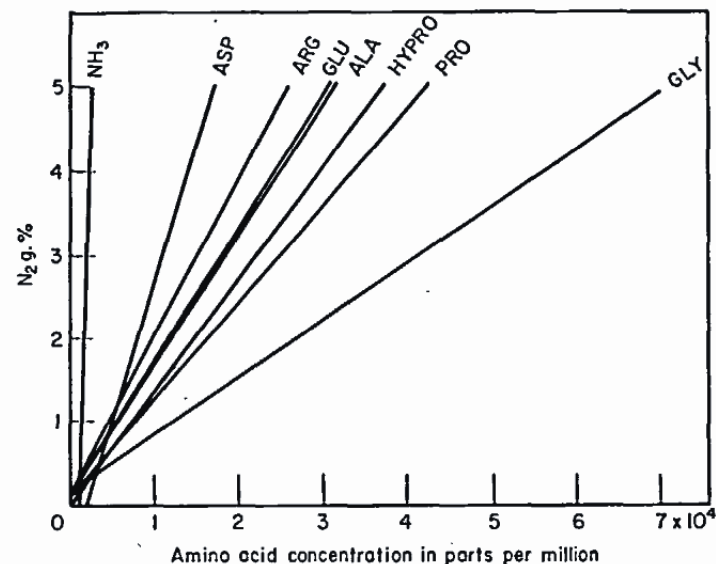


Figure 2. Glycine, proline, hydroxyproline, alanine, glutamic acid, arginine, aspartic acid and ammonia regression lines computed from data as given in Figure 1.

Obsah dusíku v kostech

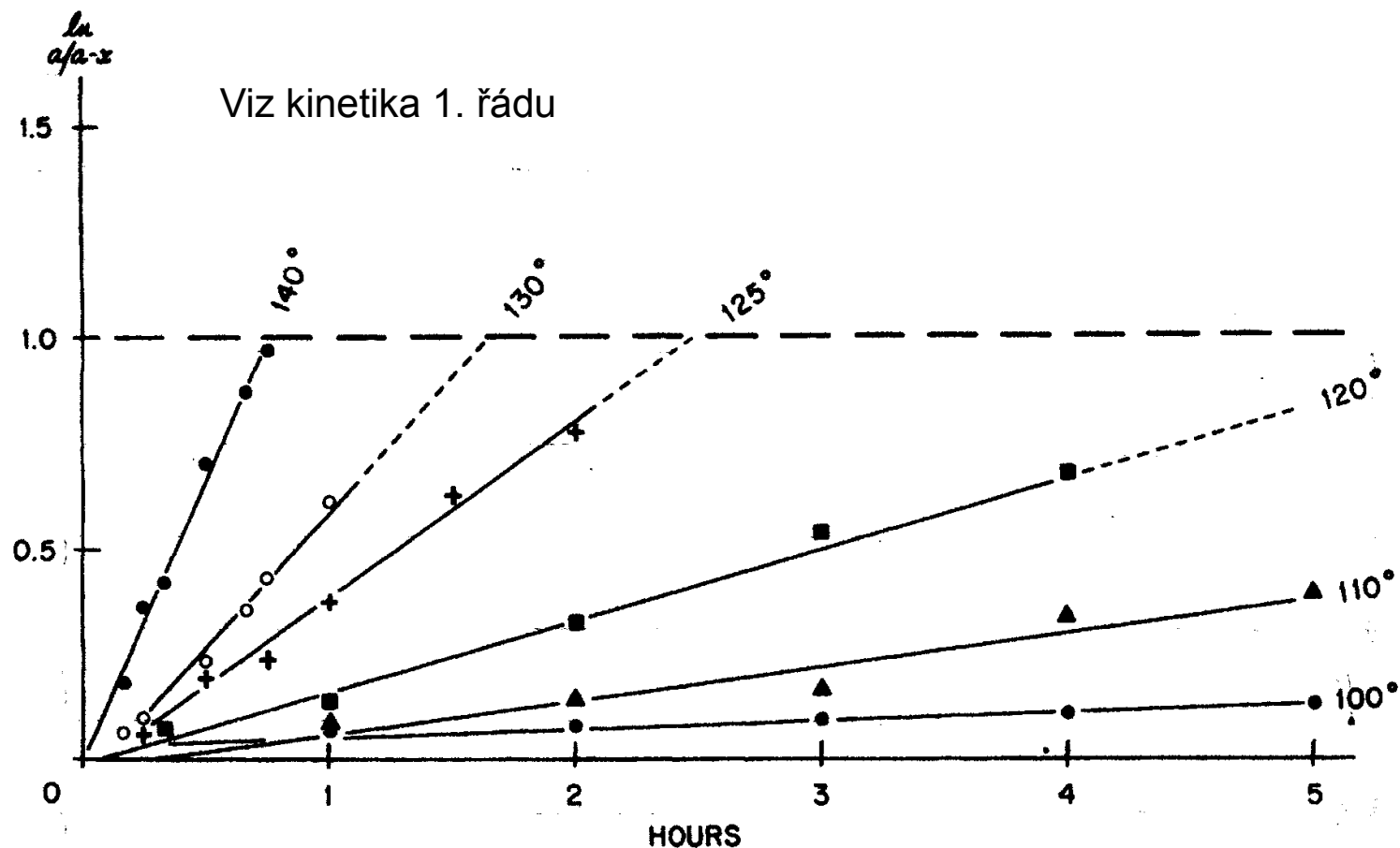
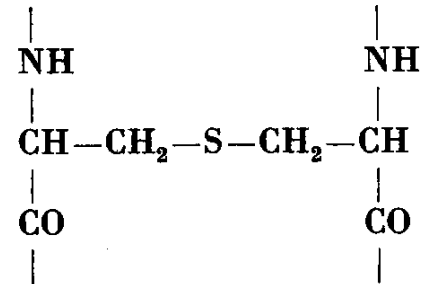


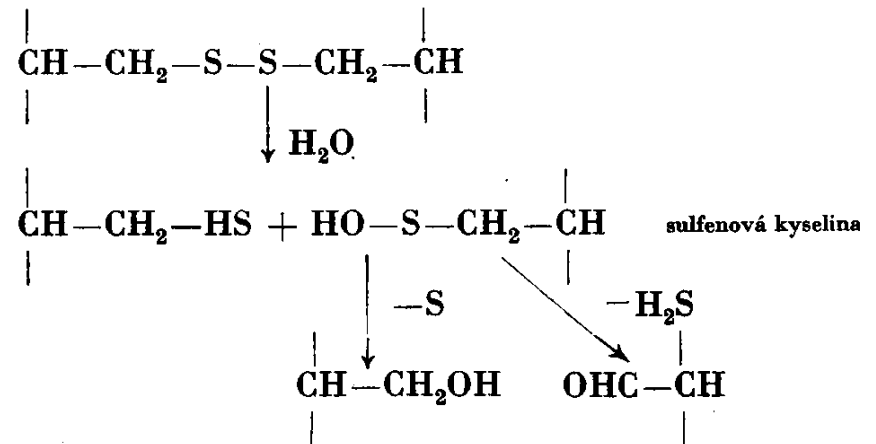
Fig. 1. The release of nitrogen from bone at 6 temperatures. The vertical coordinate represents the natural logarithm of a ratio between the initial concentration of nitrogen in bone and that which remains at any given time. The horizontal coordinate represents the number of hours each sample was heated. The temperature lines indicate the rate at which nitrogen is lost from bone at a given temperature (in degrees Centigrade). The dotted horizontal line represents those points where $a/a-x$ is equal to 2.718 and $\ln a/a-x$ equals 1.

Hydrolýza cystinu

Reakce s alkáliemi

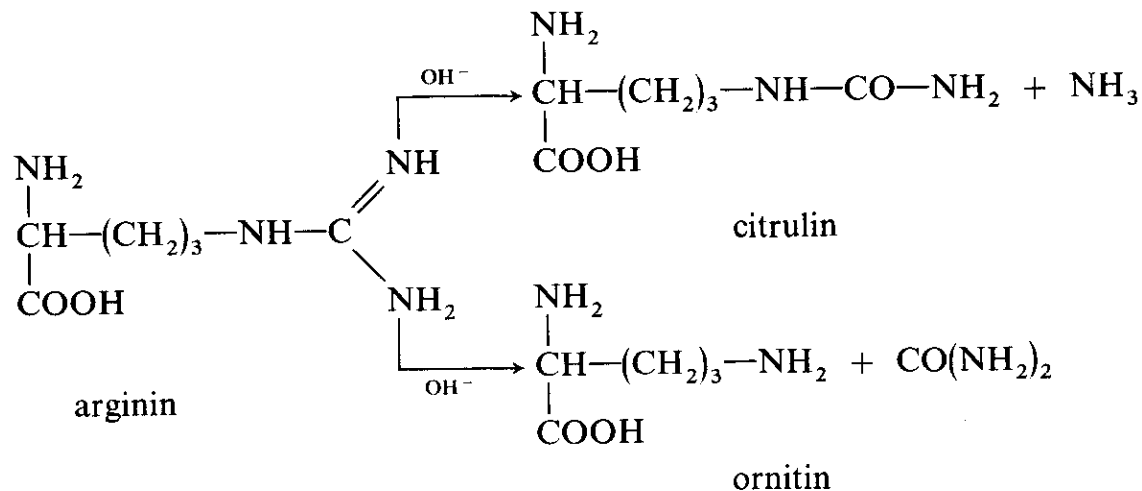


Reakce s horkou vodou



Rozklad argininu v alkalickém prostředí

V alkalickém prostředí dochází k rozkladu argininu na ornithin (za vzniku močoviny) a/nebo, méně často, na citrulin (za vzniku amoniaku). Reakce je významná hlavně v pozdějším stupni alkalické degradace kolagenu.



Reakce se uplatňuje m.j. i při loužení usně.

Aminokyselina **ornithin** se běžně v proteinech nevyskytuje.

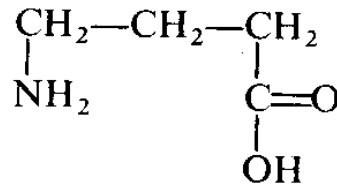
Horka-Ondrej

Existovaly pokusy o využití přeměny argininu na ornitin k datování kostí. Metoda selhala při datování lebky z paleolitické lokality Skalka u obce Horka-Ondrej na Spiši. Vysoký obsah ornitinu indikoval paleolitické stáří, radiokarbonové datování ukázalo, že jde o novověký materiál.

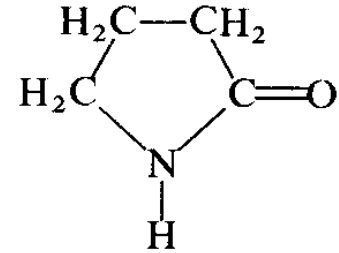
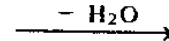


V roce 1988 v travertinu u Hôrky-Ondreje našla lidská lebka. Objev však hned od počátku budil u mnoha archeologů podezření, protože šlo o lebku zcela moderního typu. Jak se nakonec ukázalo, pochyby byly zcela na místě – šlo o podvod. Roku 2003 se k němu v televizi přiznali dva brigádníci, v době vykopávek teprve patnáctiletí. Vedoucí archeologické brigády jim prý slíbila, že najdou-li něco „velkého“, dostanou volno a navíc i nějakou tu korunu odměny. A tak se snažili. Na starém hřbitově ukradli lebku, čtyři dny ji máčeli v termálním prameni, pak ji zakopali na lokalitě a další den opatrně „objevili“.

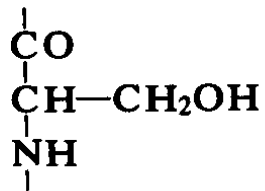
Další reakce



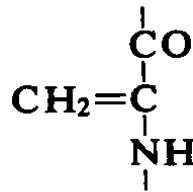
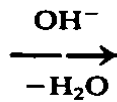
kyselina
 γ -aminomáselná



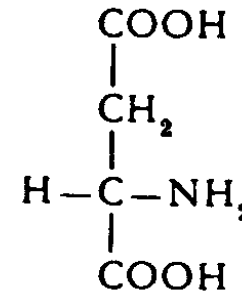
γ -butyrolaktam



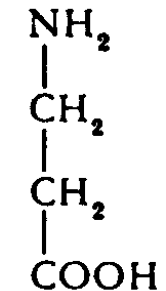
serínový zvyšok



dehydroalanínový zvyšok



aspartic acid



β -alanine

Defosforylace

Fosforylovaný Thr a Ser zbytky se mohou spontánně hydrolyticky defosforylovat za vzniku řady aduktů (například můstky lysinoalanin (LAL) a histidinoalanin (HAL)).

Obsah Ser(P) v dentinu klesá s věkem, současně přibývá Ala, LAL a HAL.

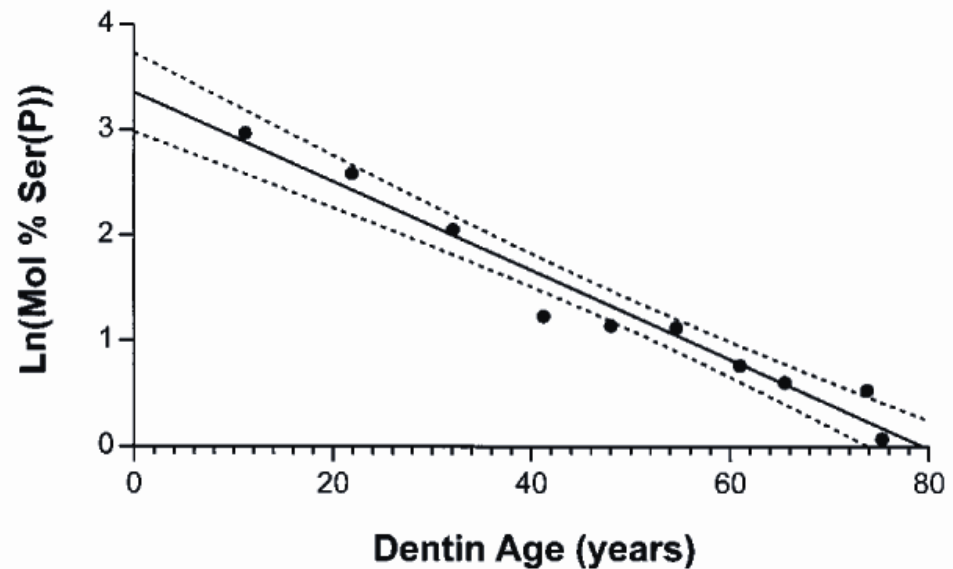


Figure 2. Contents of Ser(P) in PP from human dentin in relation to age. The amount of Ser(P) was normalized in relation to Leu. The rate of Ser(P) decomposition was: $42.2 \times 10^{-3} \text{ years}^{-1}$. Normalizing the Ser(P) values in relation to proline or alanine give approximately the same results; 41.0 and $40.4 \times 10^{-3} \text{ years}^{-1}$, respectively. The solid line represents the calculated linear regression line; broken lines represent the 95% confidence bands.

Deamidace

Působením alkálií na protein:
např. při loužení usně

Samovolně (stárnutí
proteinu), mechanismus
souvisí s racemizací.

Komplikuje datování pomocí
racemizace Asp

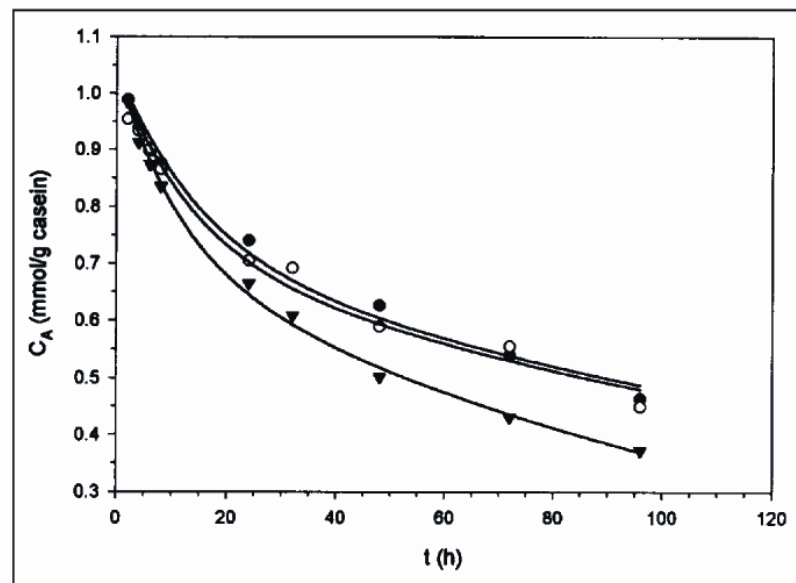
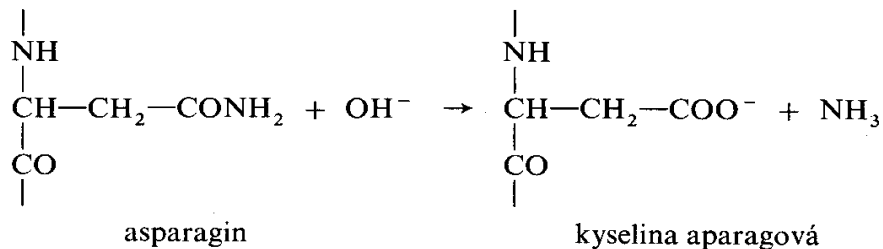


Fig. 1—Deamidation of caseins at 115°C. Solid lines represent model curves. Experimental data points: (●) calcium caseinate; (○) sodium caseinate; (▼) CO₂-casein.



Deamidace

Table 4—Deamidation activation energies (kJ/mol) of individual casein amides

	Ca-cas.	Na-cas.	CO ₂ -cas.
Asn (85-100°C)	84.6	97.2	113
Asn (100-115°C)	25.1	52.0	43.9
Gln	268	199	120

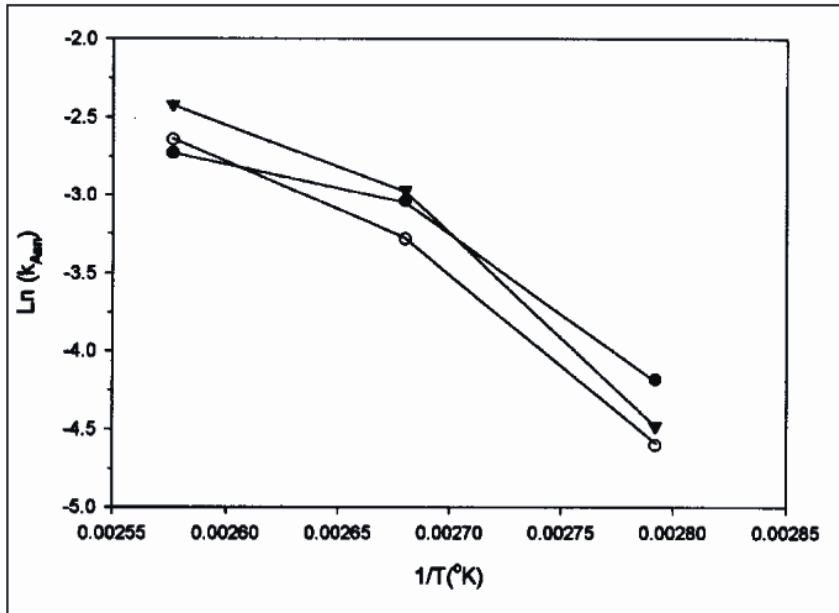


Fig. 2—Arrhenius plot for asparagine deamidation of casein. (●) calcium caseinate; (○) sodium caseinate; (▼) CO₂-casein.

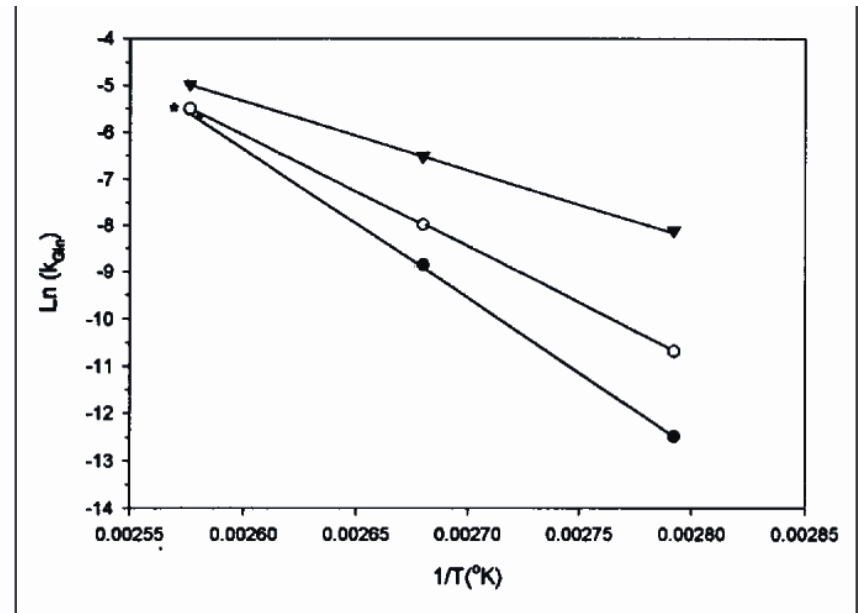
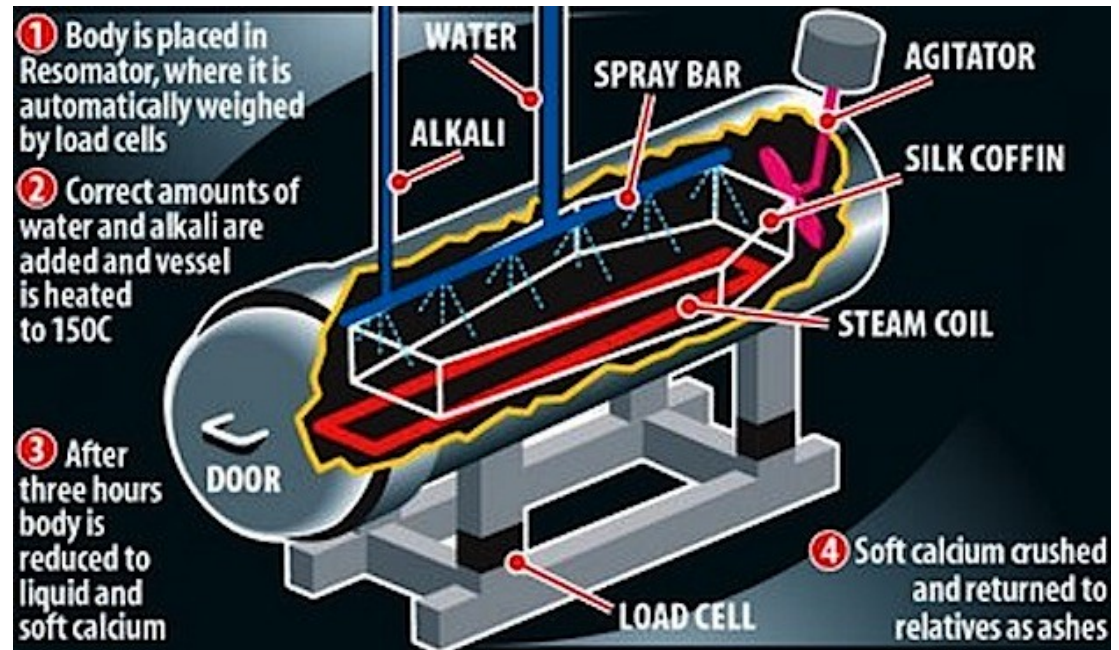


Fig. 3—Arrhenius plot for glutamine deamidation of casein. (●) calcium caseinate; (○) sodium caseinate; (▼) CO₂-casein. *Data point for calcium caseinate behind data point for sodium caseinate.

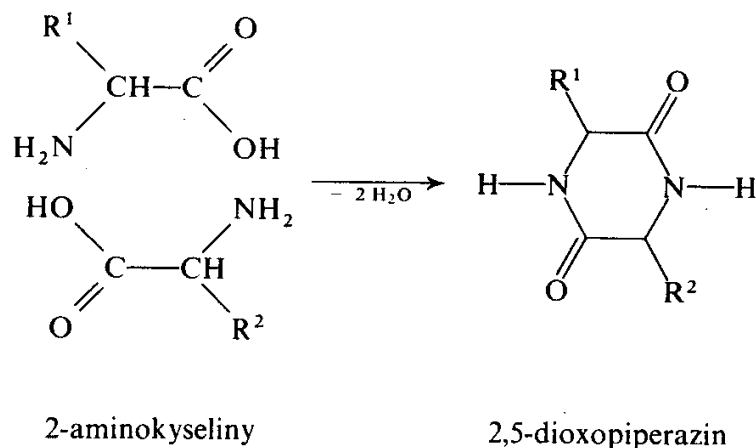
Alkalická hydrolýza

Metoda rozkladu nebožtíků pomocí alkalické hydrolýzy (green cremation, biocremation) je oproti klasické kremaci méně náročná na energii, a nedochází k uvolňování rtuti a emisím uhlíku. Proces využívá vodu, hydroxid draselný, relativně nízkou teplotu (177 C), a snížený tlak k přeměně těla na kostní fragmenty a kapalinu. Celý proces trvá cca 10-12 hodin.



Pyrolýza

Tepelnou dehydratací α -aminokyselin vznikají heterocyklické ketony (dialkylpiperaziny).



Zhruba od 150 C vznikají hnědě zbarvené produkty a těkavé složky (aldehydy, alkylnpyridiny a alkylnpyraziny, karboxylové kyseliny, aromatické uhlovodíky, ...)

Mechanismus reakcí je nejasný (radikálové reakce).

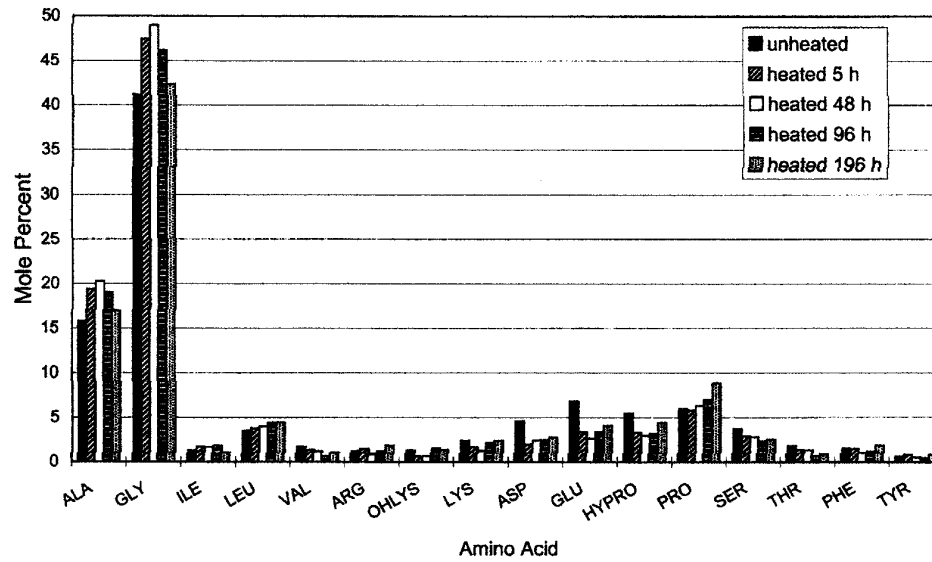


FIGURE 3—Relative abundance of amino acid (mole percent) from unheated bone and bones heated for 5, 48, 96, and 196 h in the dry heating experiment.

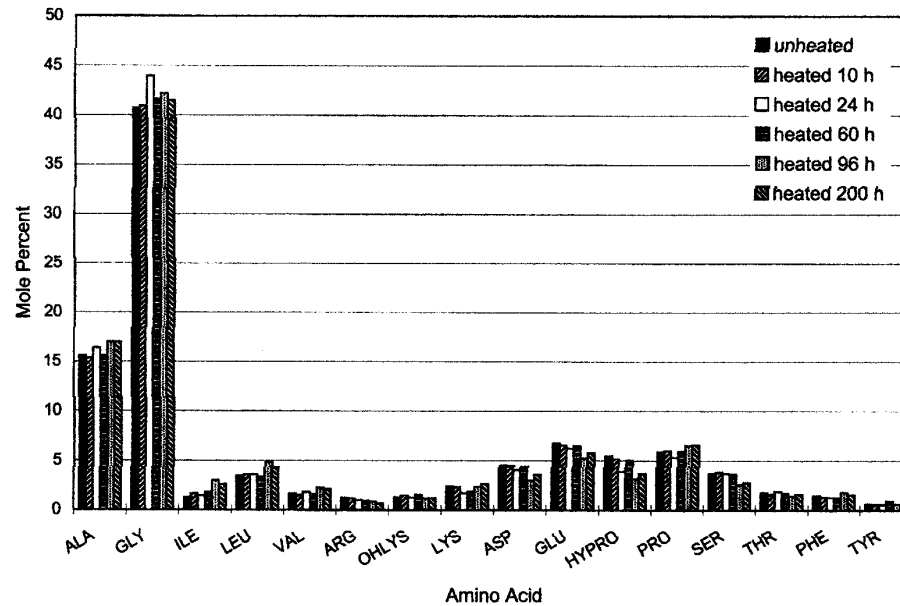


FIGURE 4—Relative abundance of amino acid (mole percent) from unheated bone and bones heated at 100°C for 10, 24, 60, 96 and 200 h in the wet heating experiment.

Pyrolýza proteinů kosti

Tepelná degradace kostí může být odhadnuta na základě poměru C/N, koncentrace NH_3 a poměru Gly/Glu.

Fig. 1 The weight percentage of insoluble char in an experimentally heated bone series. Bone specimens were freezer-milled and decalcified with 15% EDTA. Protein was solubilized and removed by hydrolysis in 6 M HCl at 100° for two days. The insoluble residue, consisting of lipids (below 200 °C) and char, was washed, recovered, lyophilized and weighed. Carbonized char is seen primarily in specimens heated to 300–500 °C, and is responsible for observable blackening.

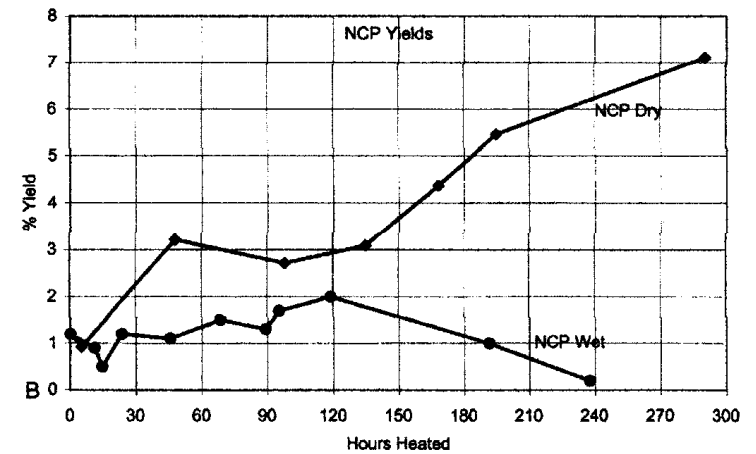
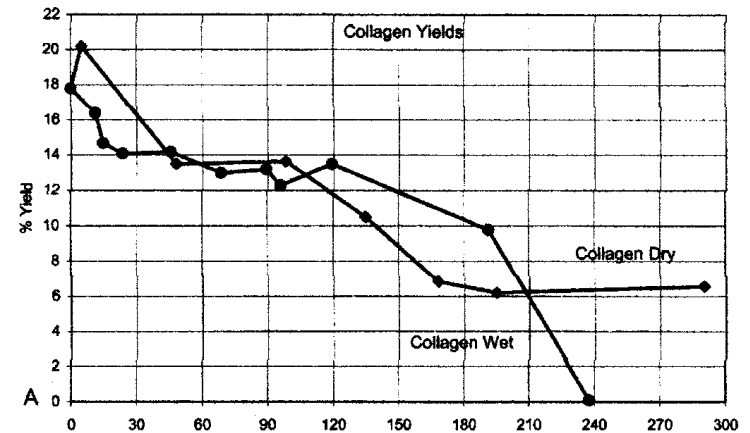
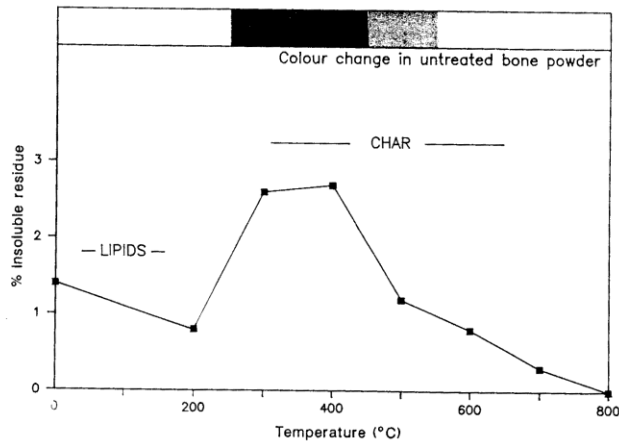


FIGURE 1—Yield of collagen (A) and non-collagenous proteins (NCP, B) extracted from unheated bone and bones heated at 100°C for up to 290 h in the wet and dry heating experiments.

Poměr C/N

Residues from experimentally heated bone series

Sample	% weight of residue	% compositic	
		C	H
Unheated	1.4	72.0	8.9
200 °C	0.8	74.0	9.3
300 °C mean	2.6	58.1	3.8
400 °C mean	2.4	58.8	3.8
500 °C	1.2	I	
600 °C	0.8	I	
700 °C	0.3	I	
800 °C	0.0	I	

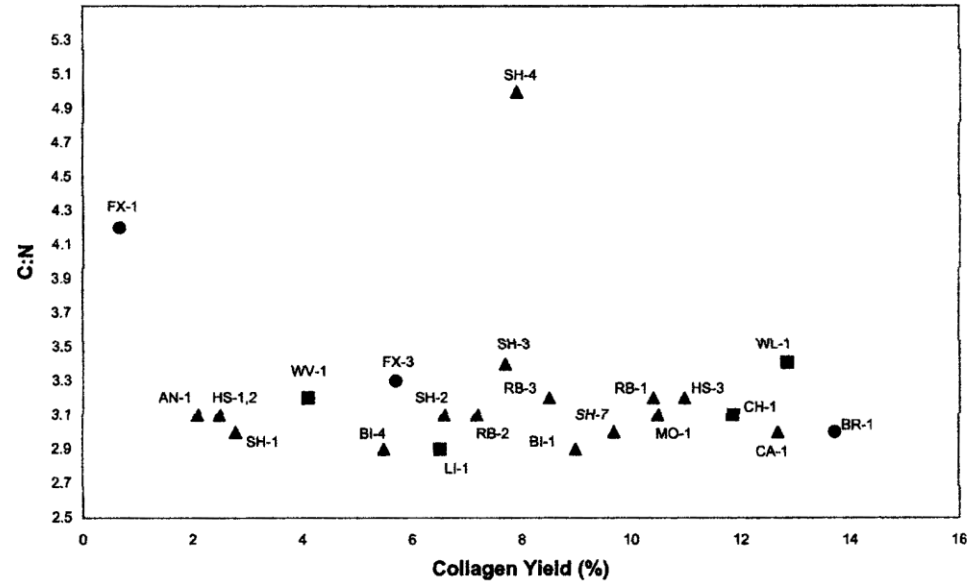


FIGURE 8—Carbon to nitrogen ratios (C:N) and collagen yield of fossils from Natural Trap Cave.

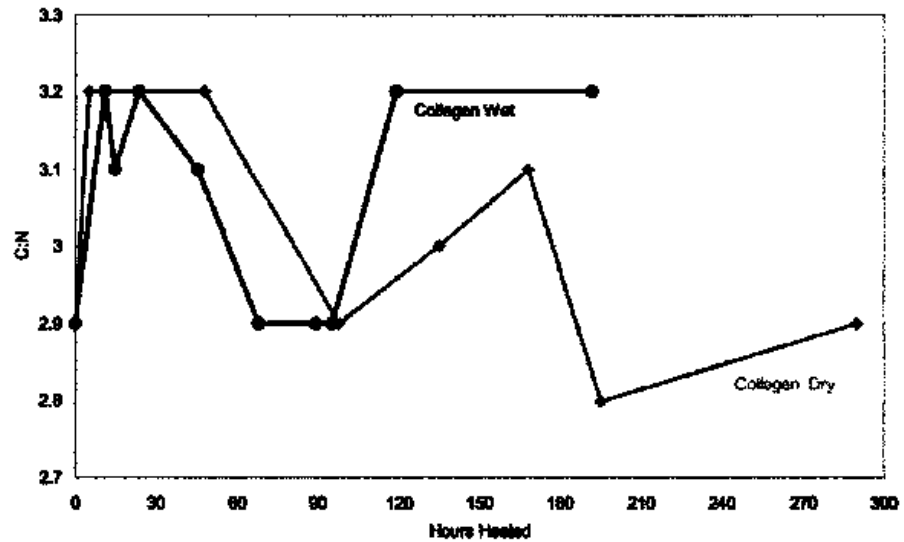


FIGURE 2—Carbon-to-nitrogen ratios of collagen extracted from unheated bone and bones heated at 100°C for up to ca. 290 h in the wet and dry heating experiments.

Pyrolýza proteinů kosti

koncentrace NH_3
a
poměr Gly/Glu

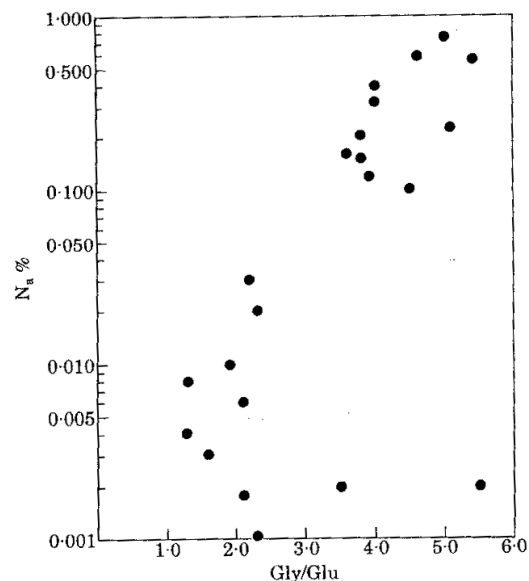


Figure 1. Plot of relationship of amino acid nitrogen content ($N_a\%$) and ratio of glycine and glutamic acid (Gly/Glu) in total hydrolysate of bones from Unit 8 at CA-LAn-43, the Encino Village site (taken from Taylor *et al.*, 1989).

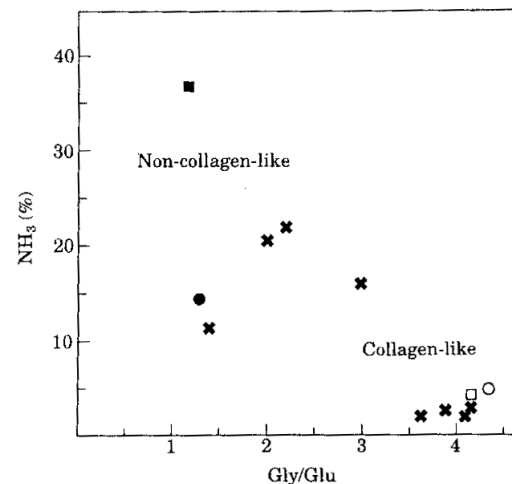


Figure 2. Plot of Gly/Glu and NH_3 values for burned and unburned bones from 5MTUMR-2346, Mancos Canyon, Colorado, taken from Tables 1 and 2. Squares designate tibial fragments (1044); circles indicate occipital fragments (1762). Solid symbols represent known burned samples; open symbols represent known unburned samples (Table 1). Crosses indicate bone samples on which Gly/Glu and NH_3 values were obtained to identify thermally-altered bone (Table 2).

Table 2. Application of Gly/Glu and NH_3 criteria to identify thermally-altered bone from Mancos 5MTUMR-2346

Context*	Visual characterization†	Gly/Glu ratio	NH_3 (%)	Analytical characterization
B7	unburned	3.63	2.40	unburned
B8a	burned	2.20	20.49	burned
B8b	burned	2.52	23.11	burned
B8c	burned	3.08	16.84	burned
B9	unburned	3.96	3.42	unburned
FA.3	burned	1.51	12.91	burned
FS19	unburned	4.33	3.53	unburned
FS30	unburned	4.18	3.15	unburned

*Site 5MTUMR – 2346 context designations: B="burial"; FA="floor artefact"; FS="floor sample".

†Evaluation based on visual characterization by TDW.

Table 1. Gly/Glu and NH_3 values of unburned and burned bone from Mancos 5MTUMR-2346

Acc. number	Thermally-effected character*	Gly/Glu ratio	NH_3 (%)
Tibial fragment			
1044a	unburned	4.23	4.47
1044b	burned	1.26	37.11
Occipital fragment			
1762a	unburned	4.38	4.83
1762b	burned	1.32	14.32

*Evaluation based on visual inspection by TDW.

Analýza spálených kosterních pozůstatků



Hoření lidského těla

$$W = A + P + F + M$$

W je hmotnost těla

A je hmotnost vody

P je hmotnost proteinů

F je hmotnost tuku

M je hmotnost minerální složky.

1. Odpaření vody (endotermní reakce)
2. Spalování tuku (exotermní reakce)
3. Spalování proteinů (exotermní reakce)
4. Spalování paliva (exotermní reakce)



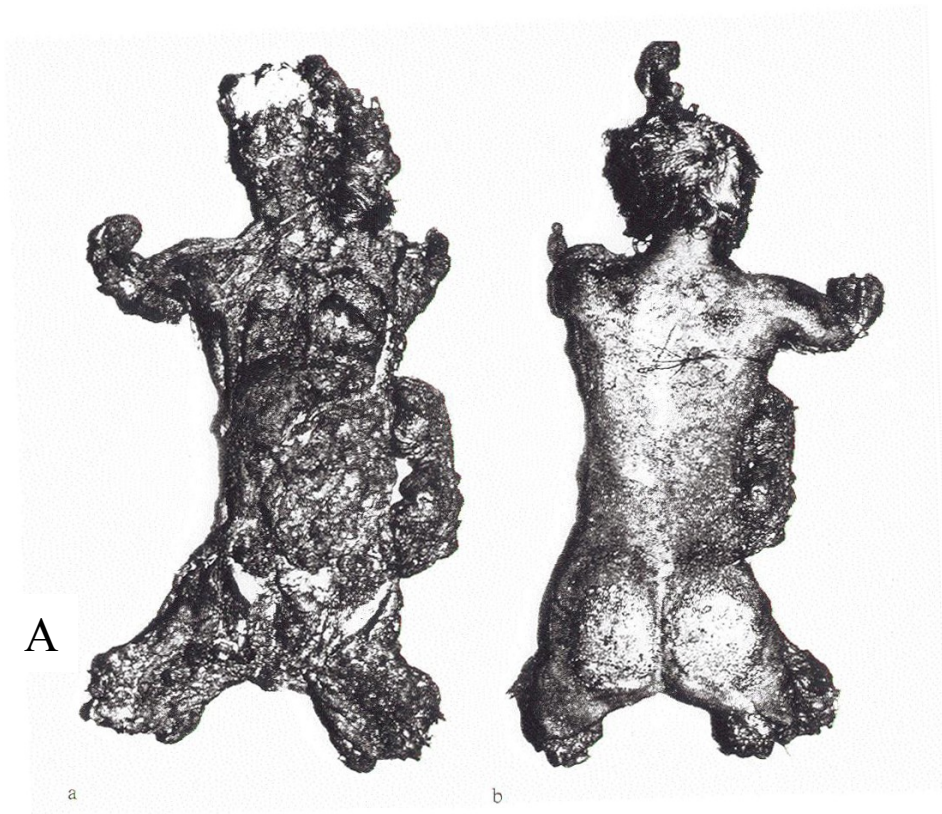
Experimenty se spalováním kostí zbavených měkkých tkání mají pro interpretaci žárového ritu velmi omezenou hodnotu !!

Obsah vody v těle a teplotní gradient

Zpomalené hoření tkání s vysokým obsahem vody.

<i>Tkáň</i>	<i>Obsah vody (%)</i>
kostra	22
tuková tkáň	30
kůže	70
svalstvo	75
mícha	70
bílá hmota mozková	70
šedá hmota mozková	86
krev	80
játra	70
ledviny	83
plíce	79
srdce	79



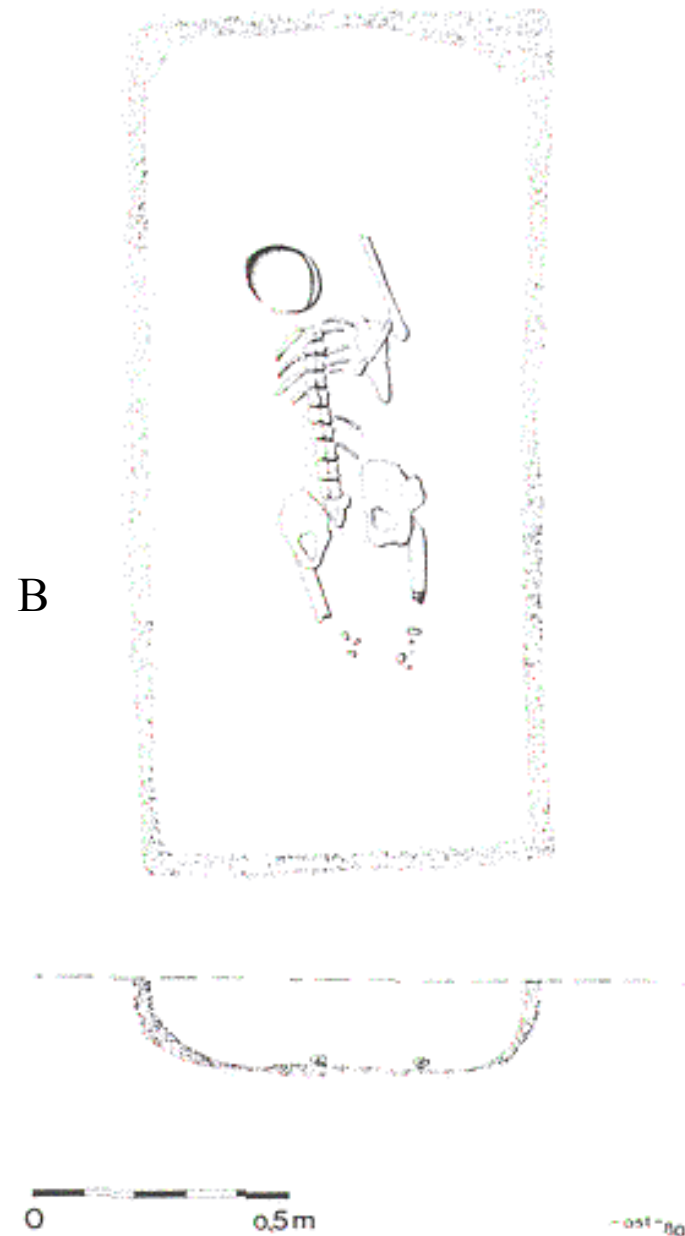


A

A forenzní případ

B pohřebiště Endingen, merovejské období

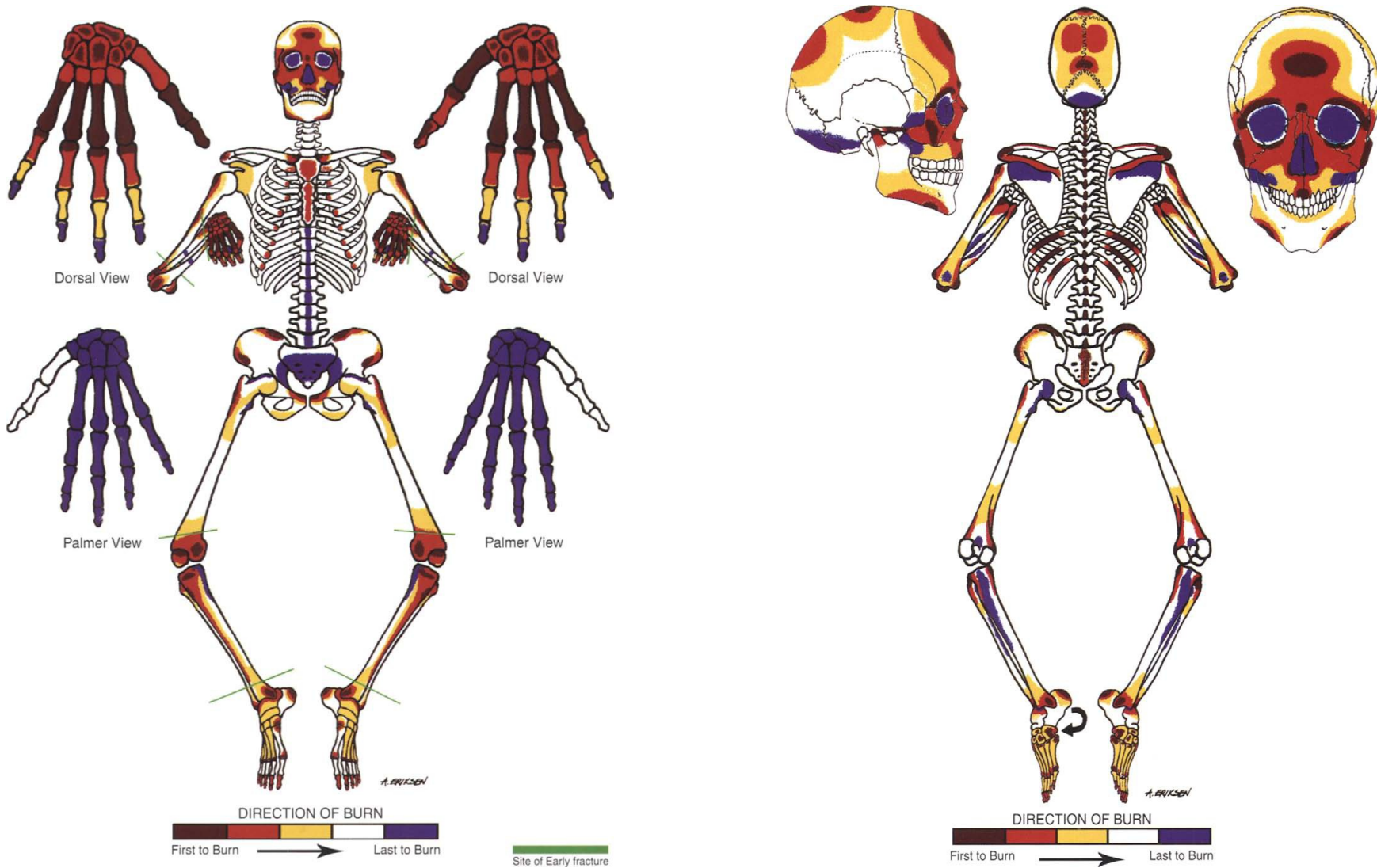
Krátkodobé působení vysoké teploty, shořely pouze partie s nízkým obsahem vody. Patrně důsledek požáru.



B

ost-10

Exponované části skeletu z hlediska obsahu vody v měkkých tkáních.

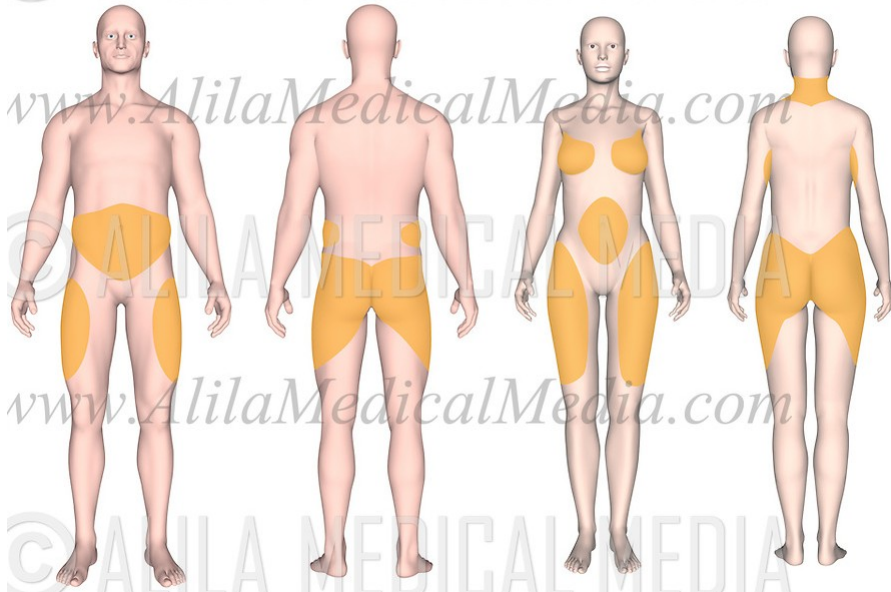


Knotový efekt

Během hoření knotu se svíčka se taví a vzniklá kapalina je kapilárním jevem nasávána do knotu, kde hoří. Lidské tělo obsahuje velké množství tuku, který se začne tavit, je nasáván oblečením, které tak funguje jako knot, a udržuje hoření.

Na rozdíl od předchozího mechanismu jsou exponovány partie s vyšším obsahem tuku. Tento mechanismus bývá spojován s jevem „spontánního uhoření“ (SHC).

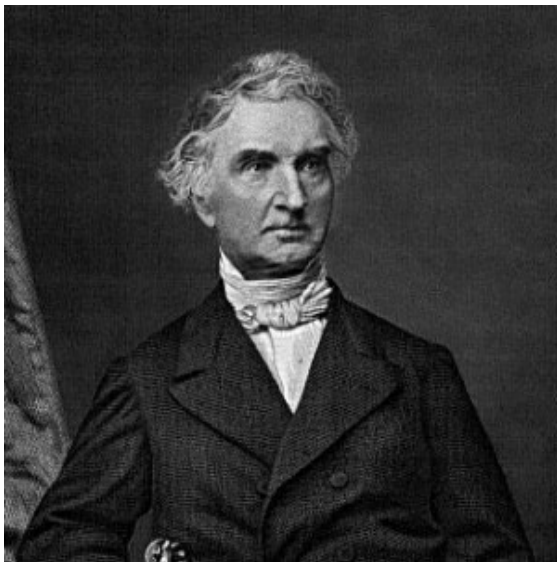
Distribution of Subcutaneous Fat in Males and Females



Smrt hraběnky von Görlitz

† 13.6.1847 , Darmstadt: v komnatách nalezeno ohořelé tělo

Původně podezření na spontánní samovznícení (SHC), později prokázán kriminální čin (vrahem byl sluha Johann Stauff). Jako expert se na vyšetřování podílel chemik prof. Justus Liebig.



Justus Liebig

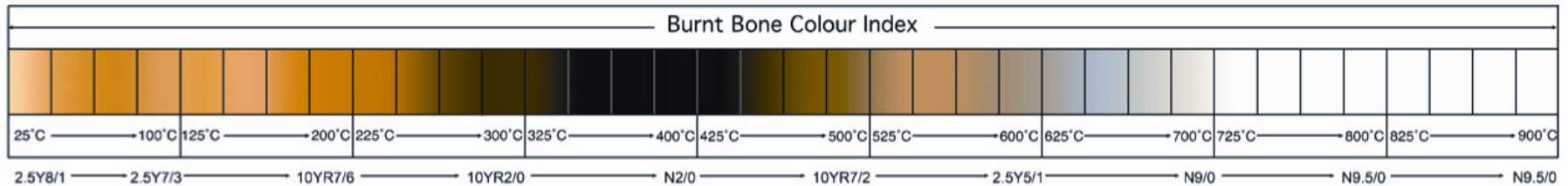


Zbarvení kosti

Temperature (°C)

Color Effects

300	Black color of cortical bone
200–400	Ultrastructural orientation of collagen fibers is well preserved
600	Gray color indicates a leaching out of the organic portion
800	White color of bone



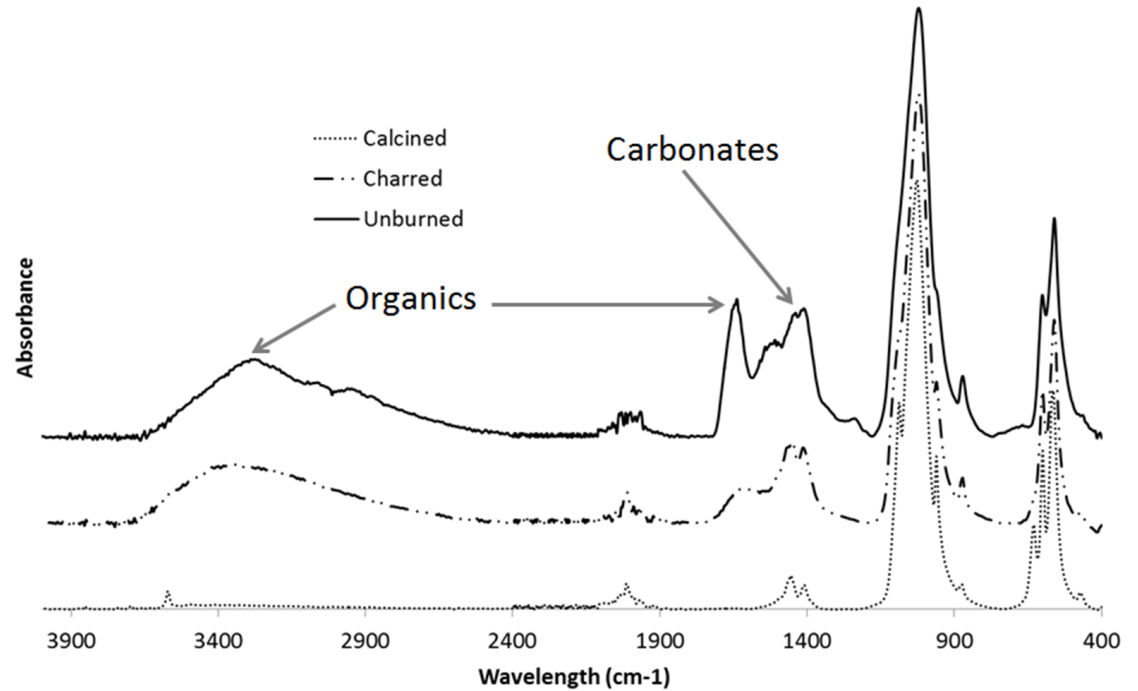
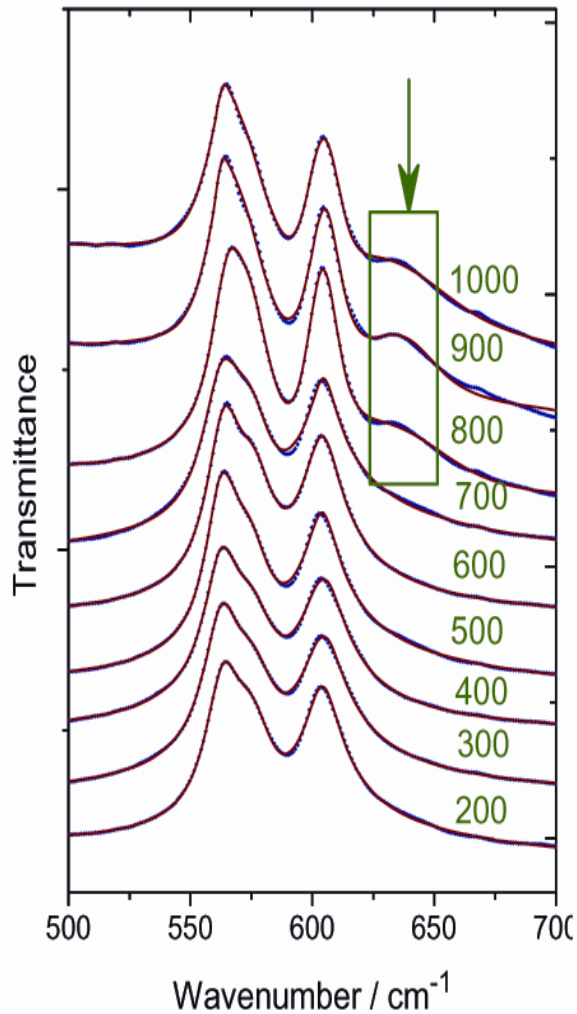
Stage of Transformation

Evidence

Revised Temperature Range (°C)

Dehydration	Fracture patterns; weight loss	100–600
Decomposition	Color change; weight loss; reduction in mechanical strength; changes in porosity	300–800
Inversion	Increase in crystal size	500–1100
Fusion	Increase in mechanical strength; reduction in dimensions; increase in crystal size; changes in porosity	700+

Metoda FTIR



Temperature ($^{\circ}\text{C}$)

Effect

300–500

H_2O removed from nonmineralized portion.

600–700

Organic carbon burnt to CO_2 and eliminated from bone.

>700

H_2O removed from apatite crystals; CO_2 formation.

>800

Physiological hydroxyapatite changes to β -tricalcium phosphate;

Shrinking 30% due to recrystallization and crystal fusion.



Hradisko Chotěbuz-Podobora



Zbytky stáje



CH-P/09
SONDA 50
CTV.C.1-2/15

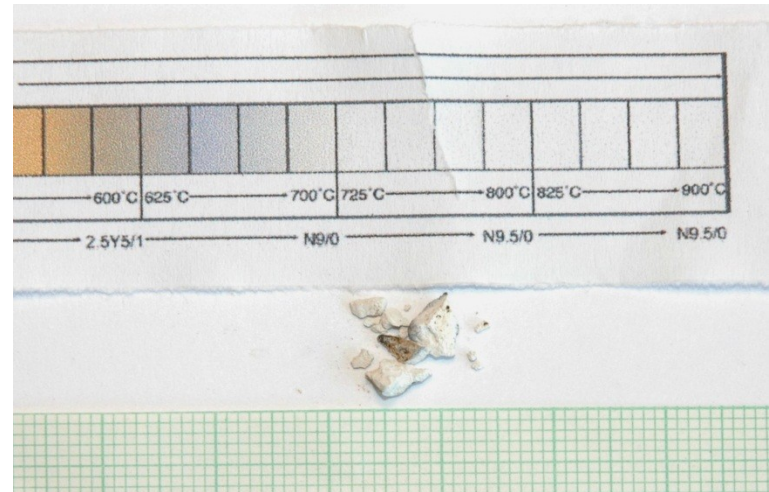
Kráva v červené elipse, **ovce/koza** v oranžové elipse, **prase** ve žluté elipse a **pes** v modré elipse.

Spálené kosti

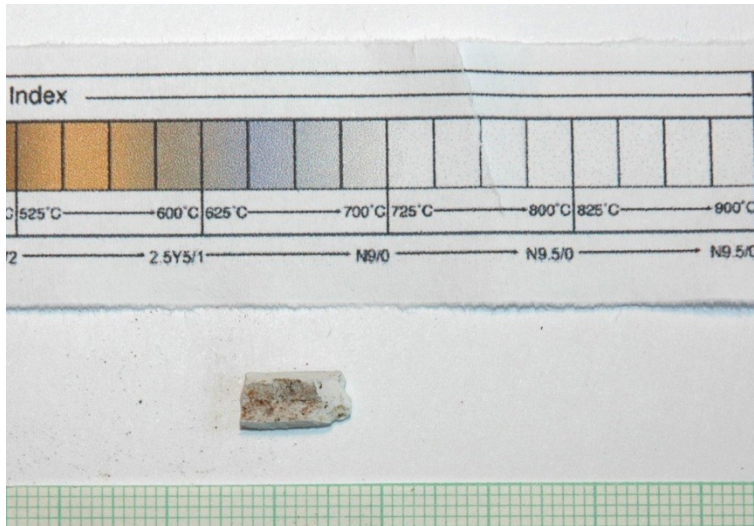
Kráva (hnědá kost)



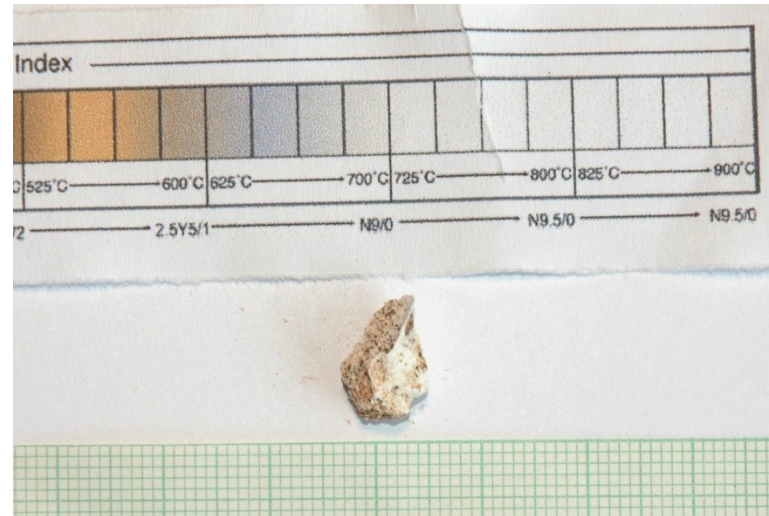
Kráva (bílá kost)



Prase



Ovce/koza



Stupeň spálení

	Dokládal 1999	Holck 1997
Kráva (hnědá kost)	Stupeň II (± 300°C)	Stupeň 1 (cca 300°C)
Kráva (černá kost)	Stupeň II (± 400°C)	Stupeň 2 (cca 400°C)
Kráva (bílá kost), prase, ovce/koza	Stupeň V (up to 750°C)	Stupeň 3 resp. 4 (up to 800°C)

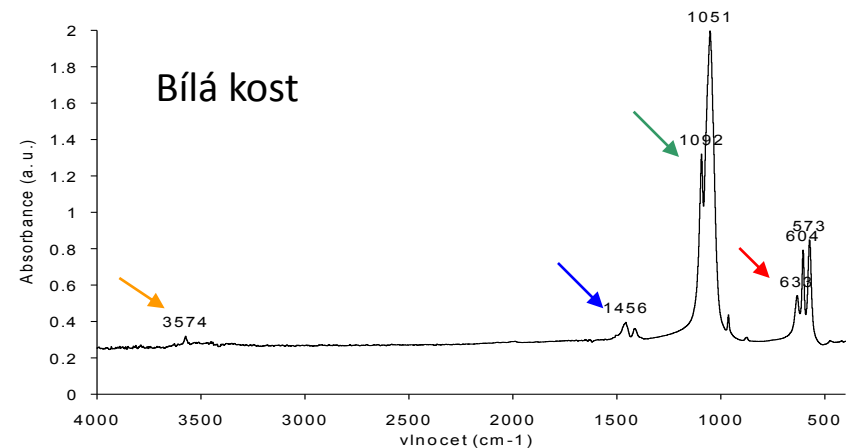
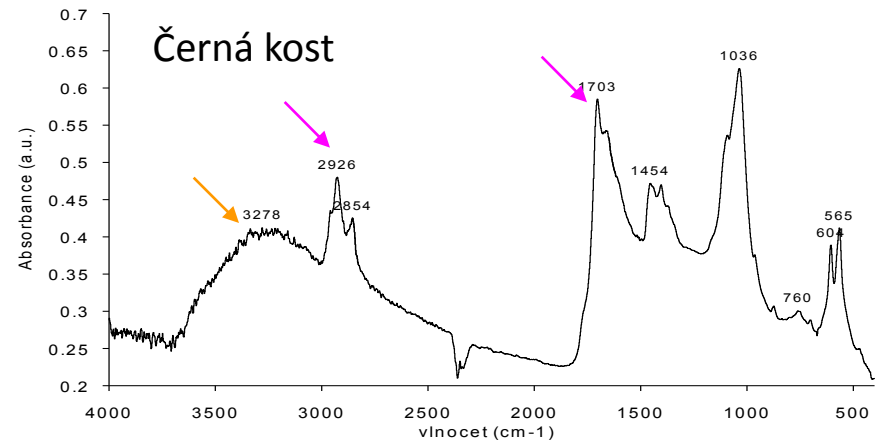
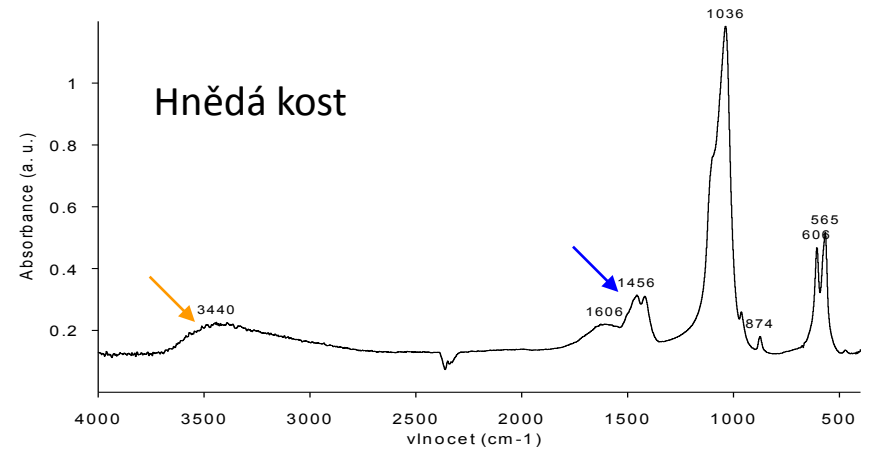
Zbarvení

	Munro et al. 2007	Walker et al. 2007
Kráva (hnědá kost)	250 – 300 °C	cca 250 °C
Kráva (černá kost)	cca 350 °C	350 – 400 °C
Kráva (bílá kost), prase, ovce/koza	> 700°C	cca 900°C

Kráva

Vliv vysoké teploty

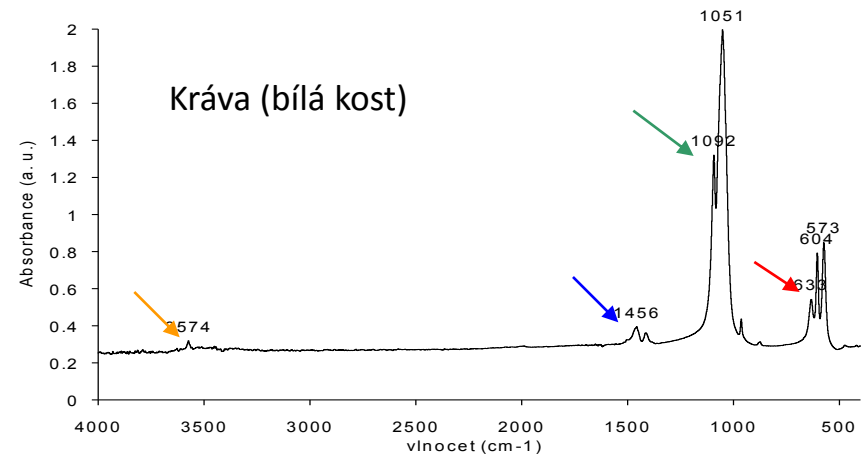
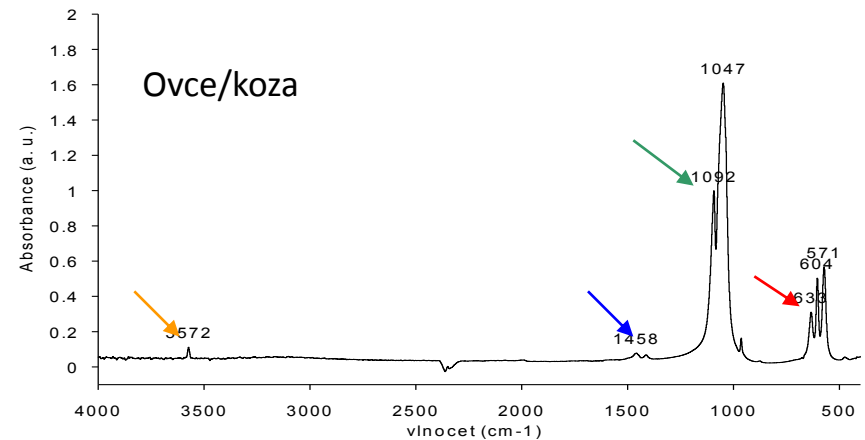
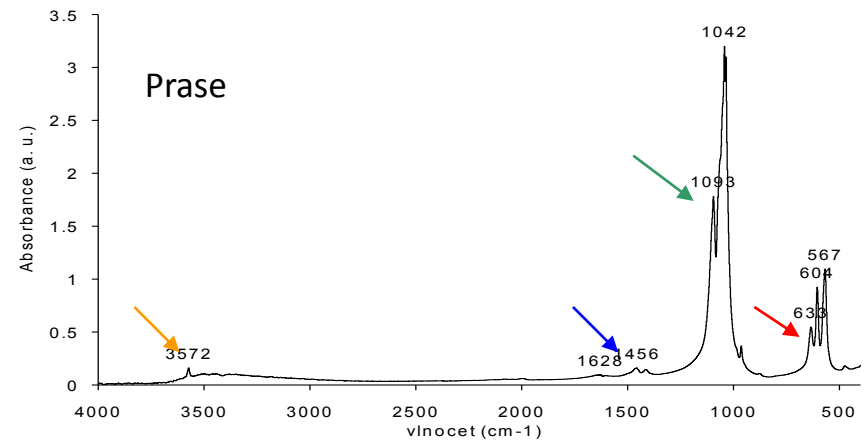
- ➔ Redukce OH pásu mezi 3600 -2600 cm^{-1}
- ➔ Redukce uhličitanového pásu (1459-1410 cm^{-1})
- ➔ Nový pás β -trikalcium fosfátu cca 1090 cm^{-1}
- ➔ Nový pás β -trikalcium fosfátu cca 655 cm^{-1}
- ➔ Pásky odpovídající organické složce kosti: C-H (2920-2950 cm^{-1}) a C=O (1700 cm^{-1}), resp. pásky N-H a O-H (3600 -2600 cm^{-1}) a C-O (1459-1410 cm^{-1} ; superpozice s pásky uhličitanu).





Teploty odhadnuté z infračervené spektrometrie (FTIR) odpovídají teplotám odhadnutým ze zbarvení a stupně spálení.

Kráva: **800 - 900 C**
 Prase a ovce/koza: **900 – 1000 C.**



Oxidace

Chemická oxidační činidla (KMnO_4 , O_3 , H_2O_2)

Fotooxidace (UV záření + O_2) – volné radikály

Radiooxidace (radioaktivní UV záření + O_2) – volné radikály

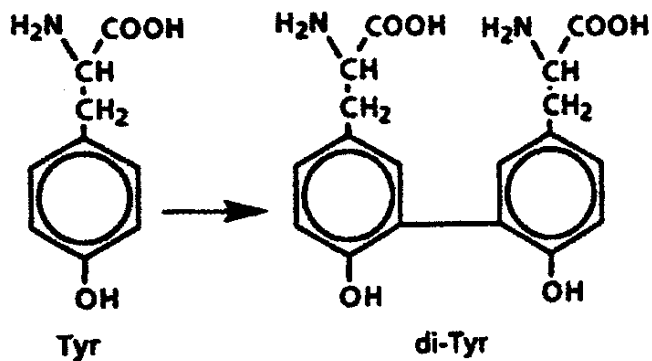


Fig. 6. Oxidation of Tyr to di-Tyr.

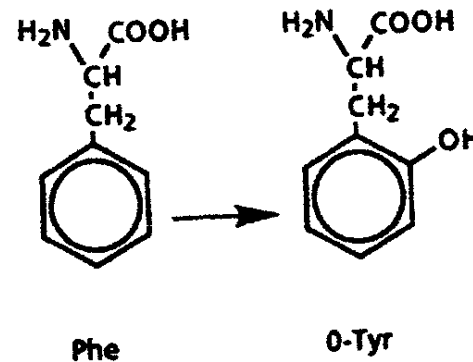


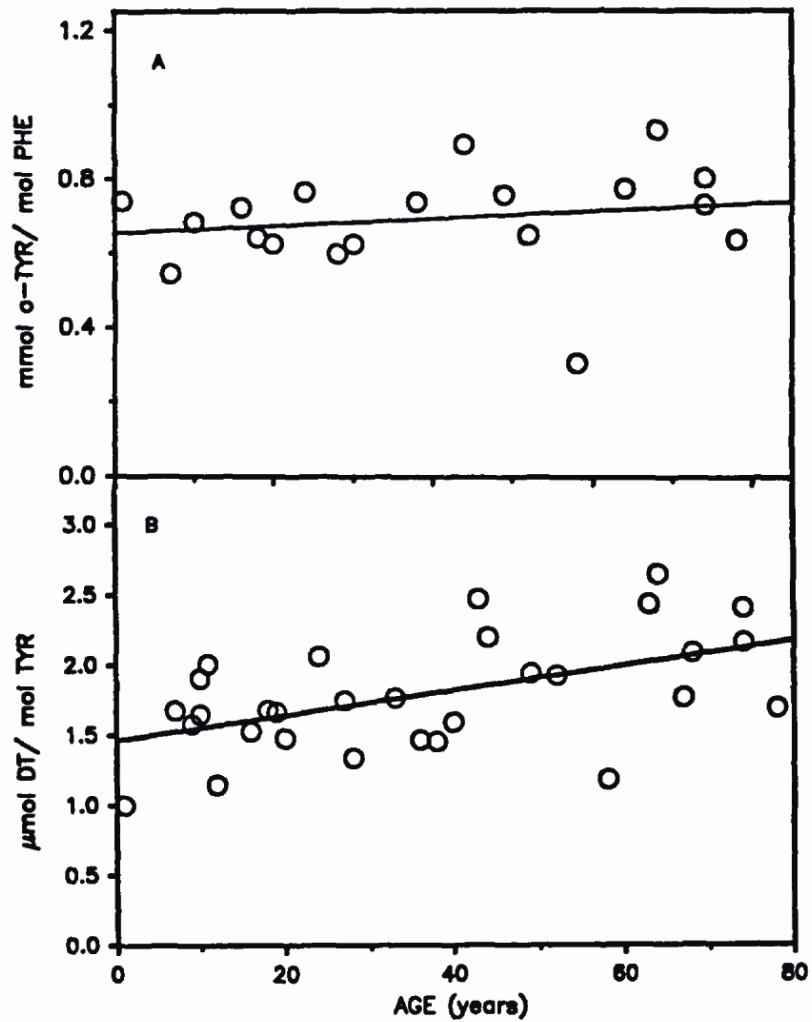
Fig. 7. Oxidation of Phe to *o*-Tyr.

Oxidace Tyr na di-Tyr

Pro vznik volných OH radikálů je nezbytná přítomnost vody !!!

Oxidace Phe na *o*-Tyr

Oxidační reakce mohou být katalyzovány přítomností kovů.



Zdravé oční čočky

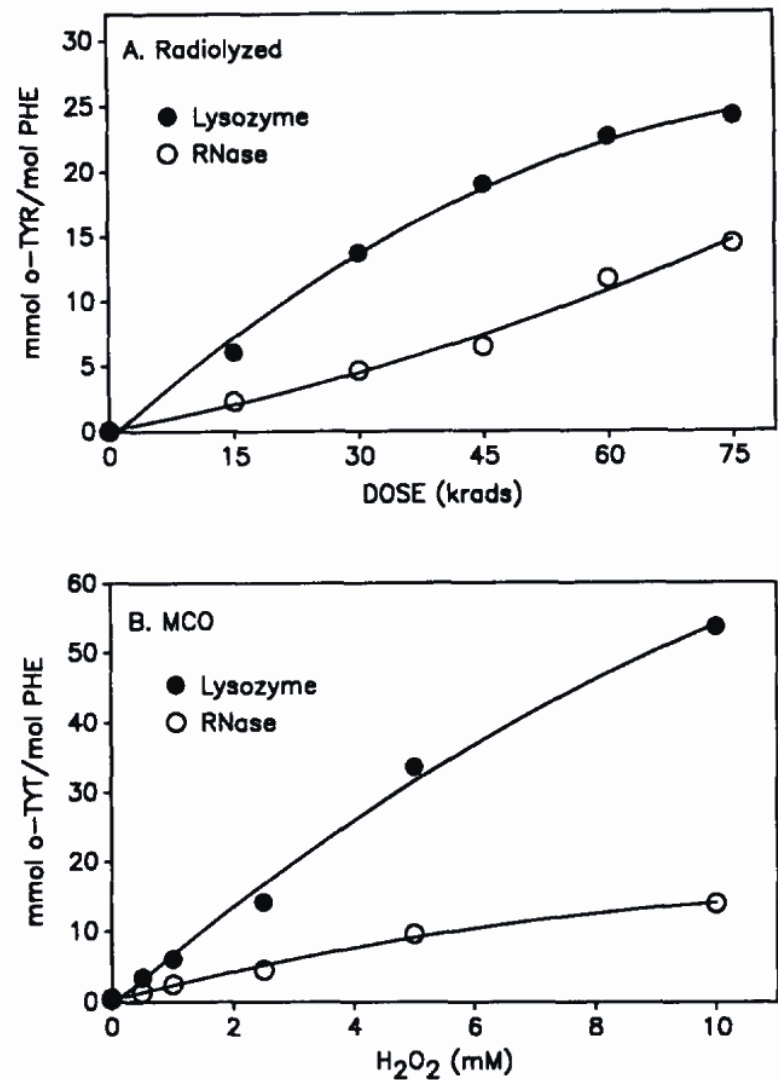
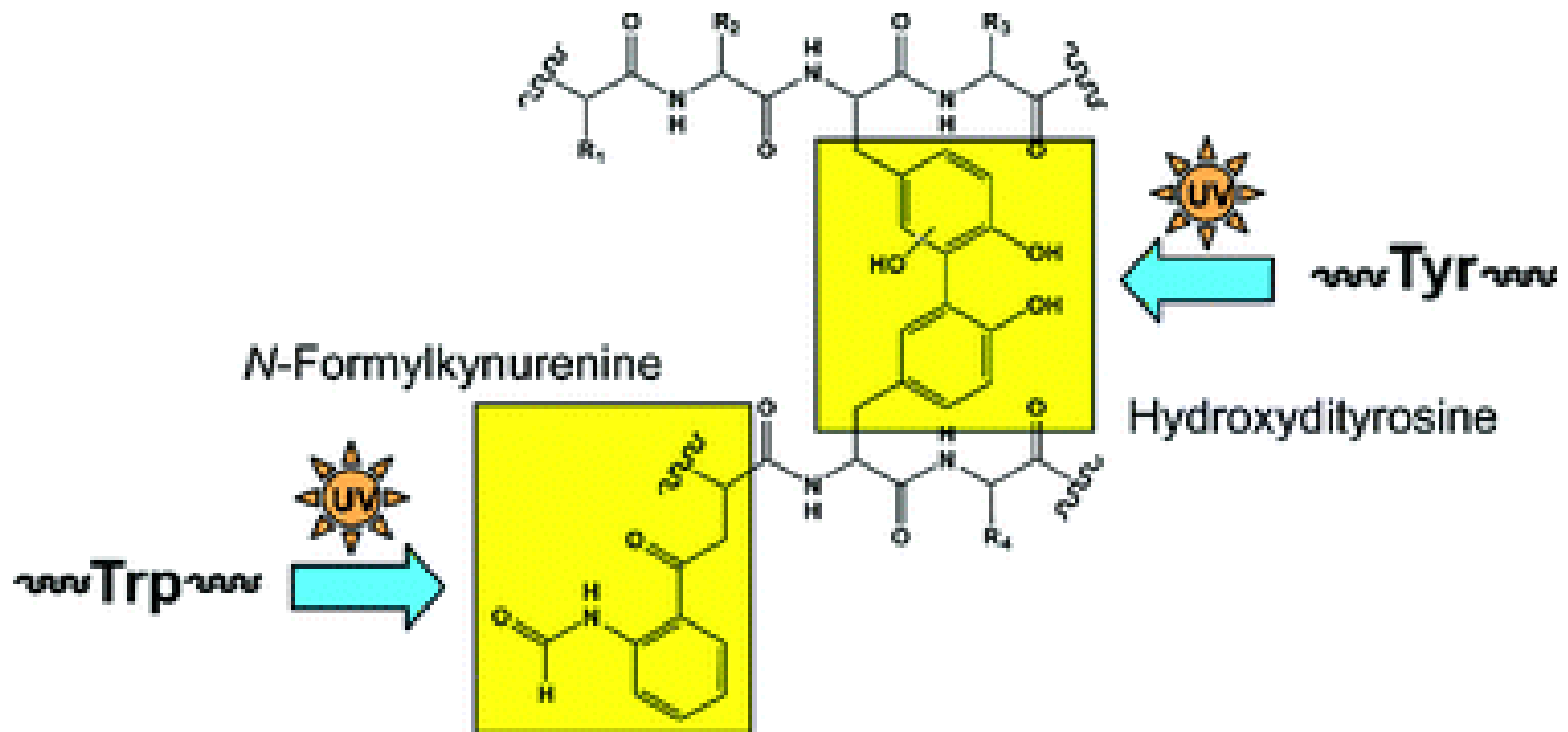


FIG. 1. Dose-dependent accumulation of *o*-Tyr in irradiated (A) and MCO-treated (B) RNase (○) and lysozyme (●).

Radiace + kalýza kovovými ionty

Žloutnutí vlny

Fotooxidace tryptofanu a tyrosinu



Oxidace methioninu

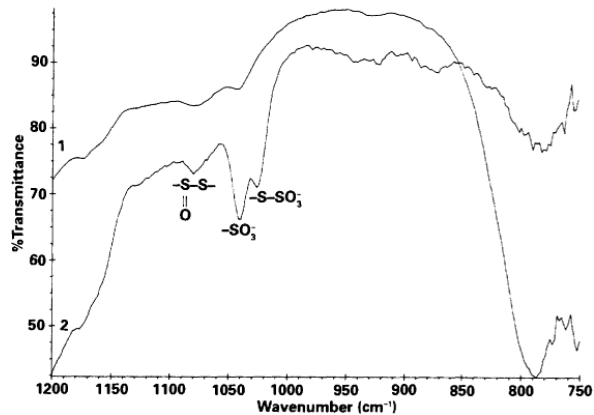


Figure 4 Infrared spectra of (1) an untreated wool fibre and (2) a wool fibre showing oxidation of disulphide bonds through the formation of cysteic acid ($-SO_3$), cystine monoxide ($-S(O)S-$) and *S*-sulphonate ($-S-SO_3$) after 99 days in the water-copper system.

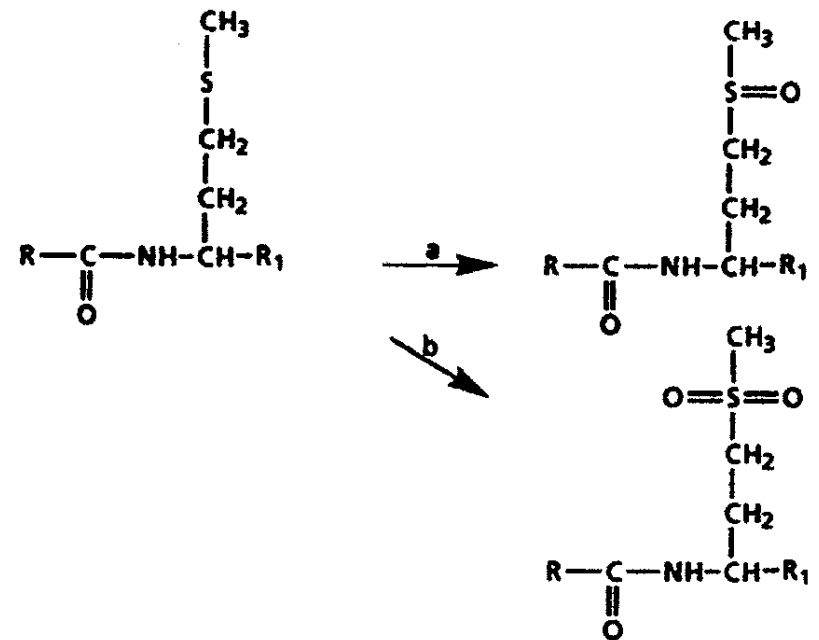


Fig. 1. Oxidation of Met under (a) mild and (b) strong conditions.

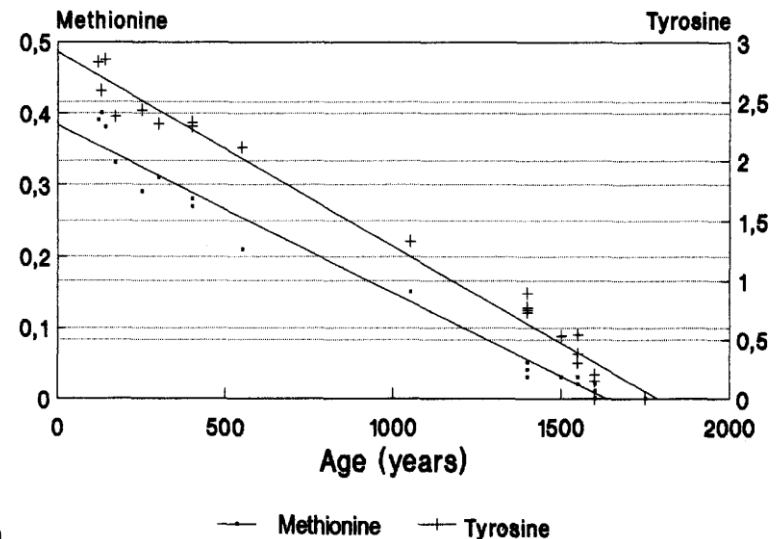
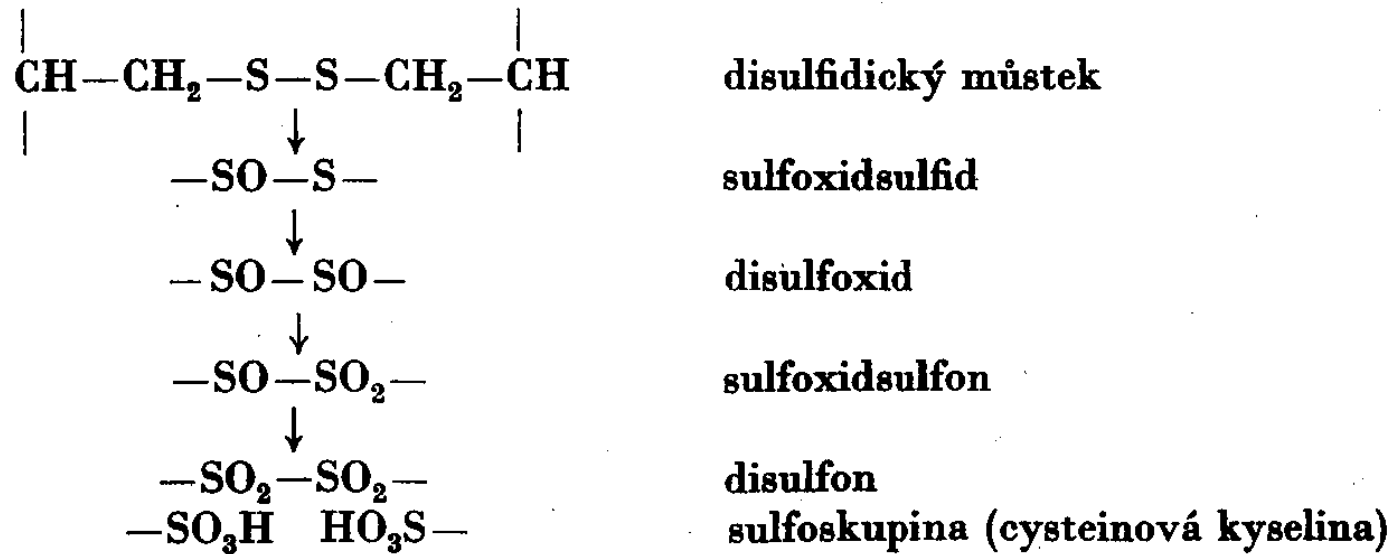
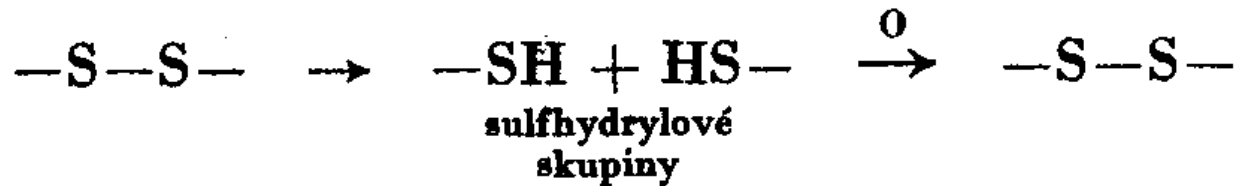
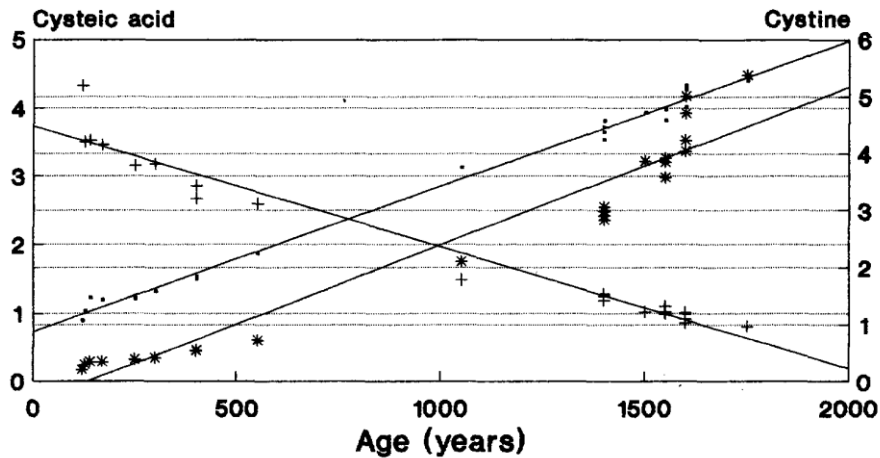


Fig. 2. Age estimation of wool based on methionine and tyrosine content.

Oxidace cysteinu a cystinu



Fotooxidace a datování



—•— Cysteic acid —+— Cystine —*— Cysteic acid/Cystine

Fig. 1. Age estimation of wool based on cysteic acid and cystine content.

Koberce z muzejních sbírek z Maďarska

Hedvábí

The First Ladies Hall in the Arts and Industries Building (Smithsonian Institution, Washington)

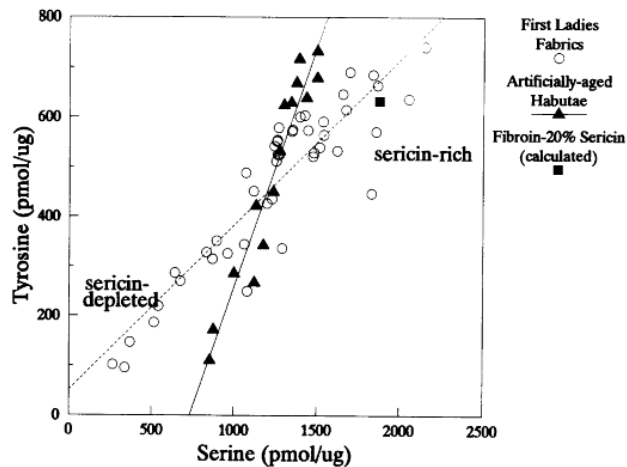


Fig. 6. The amounts of tyrosine and serine recovered from the artificially aged modern habutae and the naturally aged fabrics in the First Ladies Collection

Table 3 The ratios of glycine to several amino acids recovered from old kimono lining fabrics and artificially aged silks: average (standard deviation)

	Gly/Ala	Gly/Ser	Gly/Asx	Gly/Glx	Gly/Tyr
Control modern silk	1.49	4.10	23.76	35.56	7.94
Naturally aged					
Meiji	1.52 (0)	4.25 (0.03)	28.52 (0.62)	38.58 (0.32)	9.66 (0.31)
Taisho-Showa	1.53 (0.01)	4.23 (0.05)	27.47 (1.03)	37.23 (1.28)	9.43 (0.30)
Artificially aged*					
Indoor sunlight	1.49 (0.02)	4.19 (0.09)	26.22 (1.30)	35.95 (1.06)	8.98 (0.85)
Outdoor sunlight	1.49 (0.01)	4.30 (0.21)	27.98 (2.97)	37.76 (1.56)	10.84 (3.08)

*Adapted from [12]; exposures ranged from 100–1000kJm⁻².

Degradace fibroinu

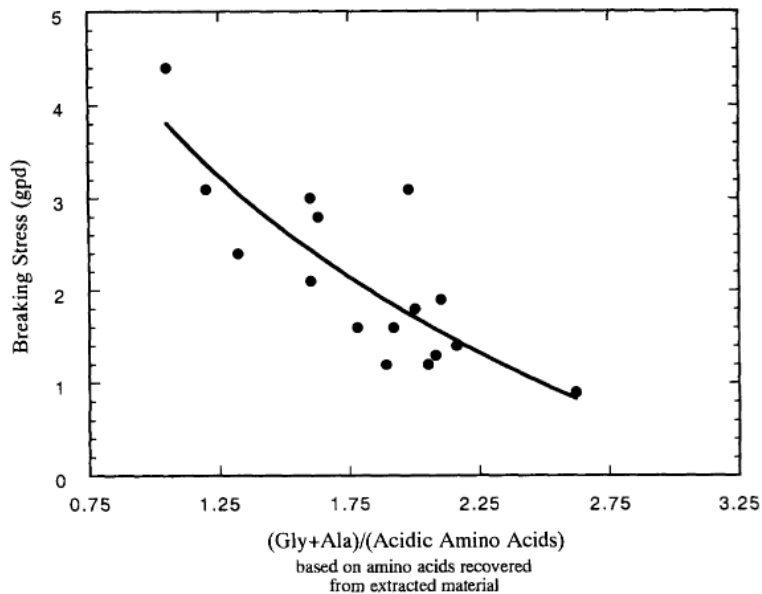


Figure 1 The relationship between the proteinaceous material extracted from old silk kimono lining fabrics and their respective warp-yarn breaking stress.

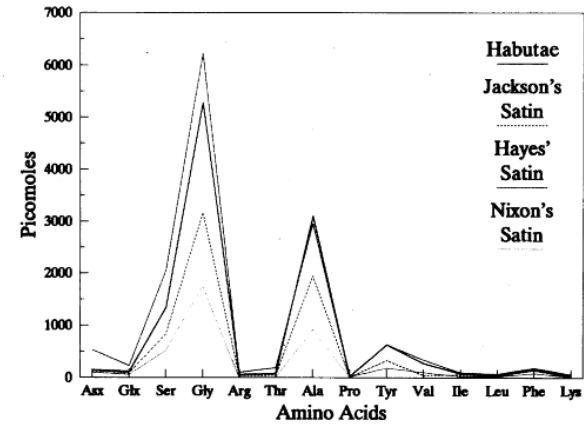


Fig. 5. Diagram showing amino acid profiles for three First Ladies fabrics compared to modern silk habutae

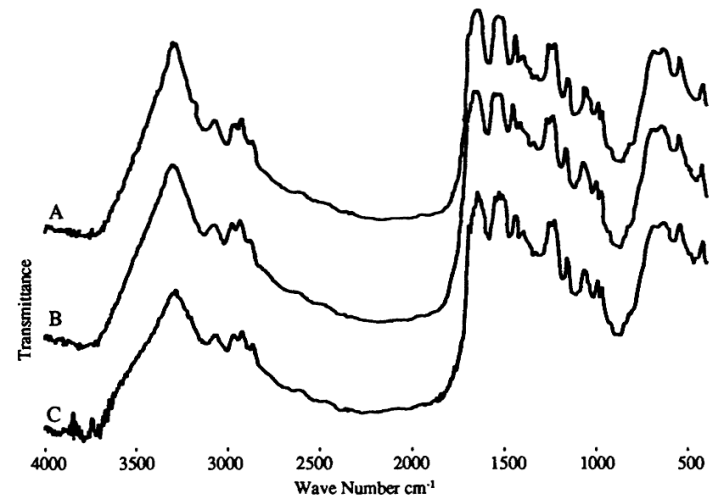


Fig. 4. Infrared spectra of unweighted silk fabrics. A: new; B: 200 years old; and C: 400 years old

Degradace vlasů

o-Tyr a di-Tyr jsou parametry ataku volnými OH radikály, zdroj OH = voda
karboxymethyllysin (CML) parametr glykoxidace

Glu – parametr degradace proteinu ve vlasech

D/L narůstá s časem, vysoká hodnota u Ötziho – důsledek UV nebo ionizujícího záření (Ginger má zhruba při stejné degradaci (Glu, CML) a stáří zhruba poloviční D/L). Pro racemizaci je nezbytná přítomnost vody.

	Recent (n=10)	Koptské hroby cca 1000 BP (n=10)	Mumie, cca 3000 BP (n=10)	Ginger cca 5200 BP	Ötzi cca 5200 BP
4trans-Hyp D/L	0,037 ± 0,012	0,190 ± 0,063	0,310 ± 0,052	0,32	0,59
di-Tyt/Tyr	-	-	0,43 ± 0,21	0,89	1,73
o-Tyr/Tyr	0,043 ± 0,032	0,108 ± 0,054	0,18 ± 0,072	0,22	0,59
CML/Lys	0,029 ± 0,013	0,12 ± 0,043	0,24 ± 0,049	0,41	0,31
Glu	26,3 ± 3,9	25,0 ± 3,3	14,9 ± 3,3	16	12

Tvorba můstků („crosslinks“)

Příčné vazby mezi řetězci proteinů.

Přirozené (stabilizace sekundární struktury, patologické procesy)

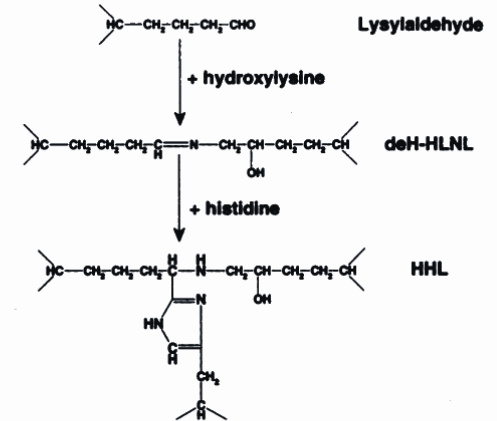
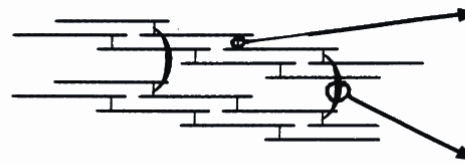
Umělé (zpracování kůže, mumifikace, vliv úložného prostředí)

Příčné můstky v kolagenu

Kovalentní intermolekulární můstky (cross-links) zajišťují stabilitu a mechanickou pevnost kolagenové matrice kosti.

ENZYME (LYSYL OXIDASE) CROSS-LINKS

(a) SKIN COLLAGEN



(b) BONE COLLAGEN

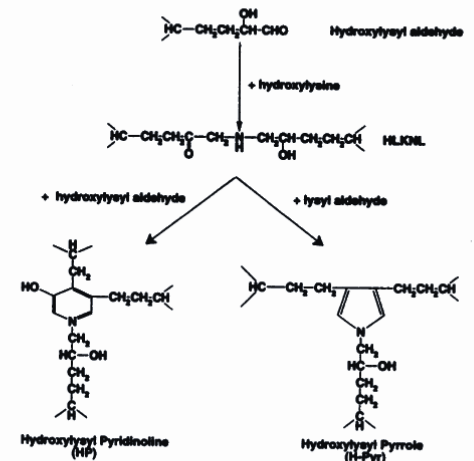
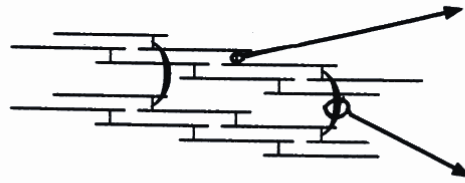


Fig. 4. Nature and proposed location of the enzyme mediated cross-links in (a) skin. Lysylaldehyde forms the immature cross-link deH-HLNL, which then matures to HHL. (b) bone. Hydroxylysylaldehyde forms the immature cross-link HLKNL, which then matures to the pyridinolines and the pyrroles. In skin collagen, the telopeptide lysines are not hydroxylated, whilst on bone collagen, they are about 50% hydroxylated, and in articular cartilage collagen they are 100% hydroxylated, leading to different mature cross-links.

Nuraghi

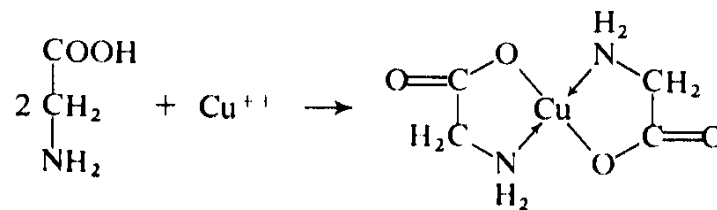
Sardinie (1500-1200 BC), populace je nazývána podle megalitických monumentů - pohřebišť. Kostí byly velmi dobře zachovalé. Můstky byly sledovány na řezu kosti a zubu mikroskopii v polarizovatelném světle a po dekalifikaci a hydrolýze vzorku byly kvantifikovány metodou HPLC.



	Kosti	Nuraghic (mol/mol kolagenu)	Modern (mol/mol kolagenu)
Redukovatelné	dehydro-dihydroxylysinorleucin (deH-DHLNL)	0,07 ± 0,01	0,42 ± 0,06
	dehydro-hydroxylysinorleucin (deH-HLNL)	0,18 ± 0,04	0,30 ± 0,06
Stabilní	Pyridinolin (Pyr)	0,05 ± 0,02	0,25 ± 0,08
	Deoxypyridinolin (d-Pyr)	0,025 ± 0,014	0,040 ± 0,015

	Dentin	Nuraghic (mol/mol kolagenu)	Modern (mol/mol kolagenu)
Redukovatelné	dehydro-dihydroxylysinorleucin (deH-DHLNL)	0,16 ± 0,05	0,72 ± 0,16
	dehydro-hydroxylysinorleucin (deH-HLNL)	0,13 ± 0,03	0,23 ± 0,06
Stabilní	Pyridinolin (Pyr)	0,095 ± 0,005	0,35 ± 0,05
	Deoxypyridinolin (d-Pyr)	0,002 ± 0,001	0,08 ± 0,02

Reakce s kovy



Vlna:

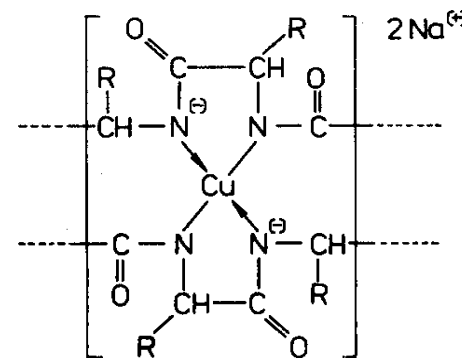
solí těžkých kovů (Cu, Fe, aj.)
jsou silně adsorbovány

Hedvábí:

značná afinita k iontům těžkých
kovů, „zatěžkávání hedvábí“

Kůže

činění solemi kovů (Al, Cr, Ca),
vazba na karboxyl



„Zatěžkávané hedvábí“

pro zvýšení jeho hmotnosti po degumování
(odklížení = zbavení sericinu)

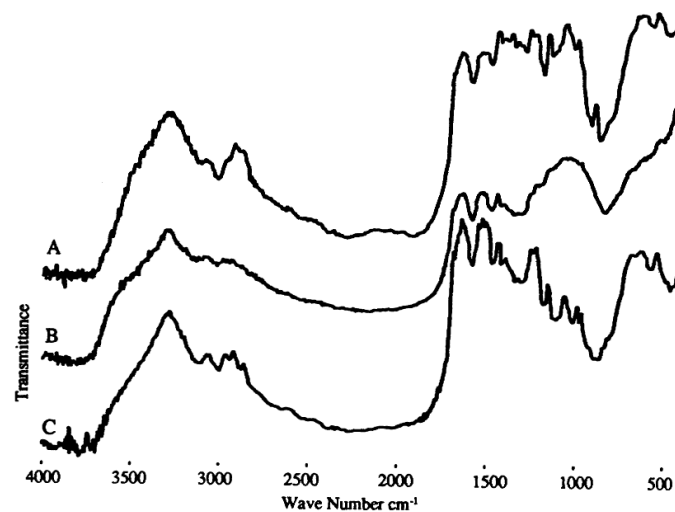
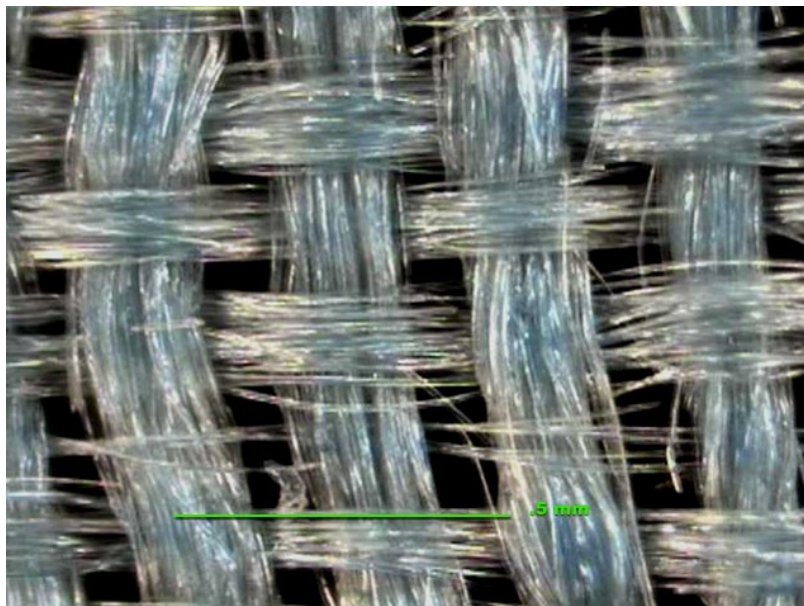


Fig. 5. Infrared spectra of unweighted and weighted silk fabrics. A: unweighted new; B: tin weighted; 60 years old; C: chromium weighted, 80 years old

Mineralizace textilních vláken

Mineralizace vláken vysrážením
měďnatých solí z korozních produktů
ve struktuře vlákna.

Tyto soli mají biocidní účinky.

Pokud ionty katalyzují rozklad vlákna
(celulóza), vznikají pseudomorfy.

Charakter krystalizace je ovlivněn
pH a Eh = Pourbaixovy diagramy

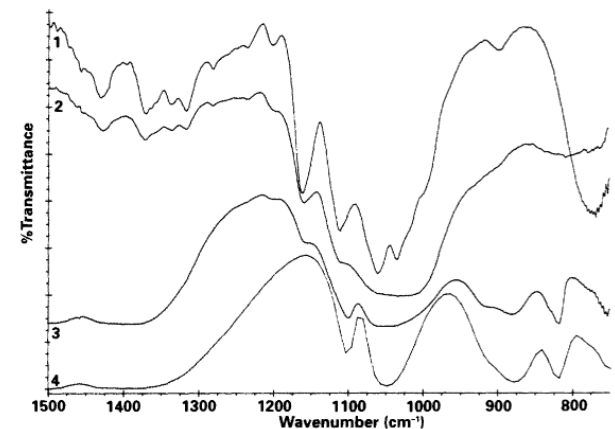
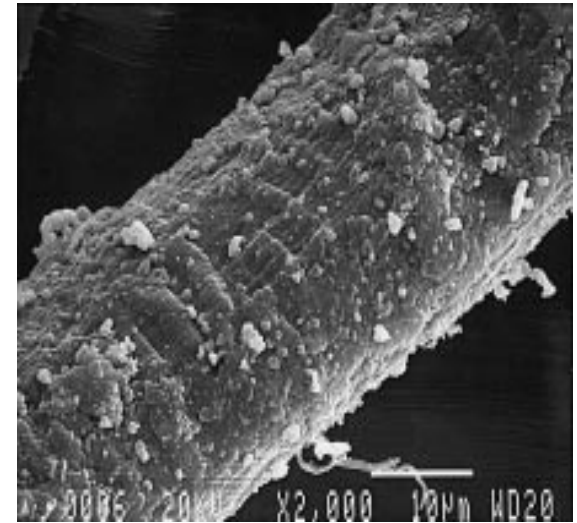


Figure 7 Infrared spectra of (1) an untreated cotton fibre, (2, 3) two areas from a highly mineralized seventh-century B.C. fibre, and (4) malachite, $\text{Cu}_2\text{CO}_3(\text{OH})_2$. The archaeological sample clearly shows the presence of both a cellulose component and the copper mineral.

Boráty



Natron obsahující kyselinu boritou

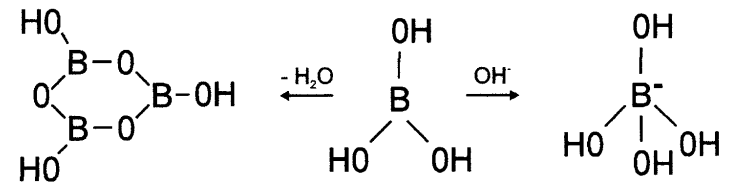


Fig. 1. Trigonal planar and tetrahedral structure of boric acid.

Comparison of sodium and borate content as well as alkaline phosphatase activity in bone samples of Pharaonic Egypt derived from different excavation sites

Historical period	Sample	Excavation site	Sodium ($\mu\text{mol/g}$ bone)	Borate ($\mu\text{mol/g}$ bone)	Alkaline phosphatase (mU/g bone)
Contemporary autopsy			306	0	352.0 ± 32.0
Ptolemaic period	Inv. No. 17668 ^a	Unknown	n.d.	1.30 ± 0.2	5.8 ± 0.3
Old Kingdom	W5241 ^b	Giza	335	0	0.7 ± 0.03
	W9257 ^b	Giza	1231	0.95 ± 0.10	14.8 ± 1.3
	W9259 ^b	Giza	397	0	3.5 ± 0.5
	W9260 ^b	Giza	1120	0.25 ± 0.05	4.4 ± 0.1
	W9261 ^b	Giza	1498	1.15 ± 0.05	5.4 ± 0.2
	W9307 ^b	Giza	354	0	0
	W9323 ^b	Giza	468	0	0
	S15803 ^c	Gebelein	227	0	0
	Inv. No. 3052 ^d	Giza	n.d.	0	0
	Inv. No. 3114 ^d	Unknown	n.d.	0	0
Inv. No. 14702 ^a	Unknown	n.d.	0	0	

Tvorba esterů kys. borité, které protein stabilizují.

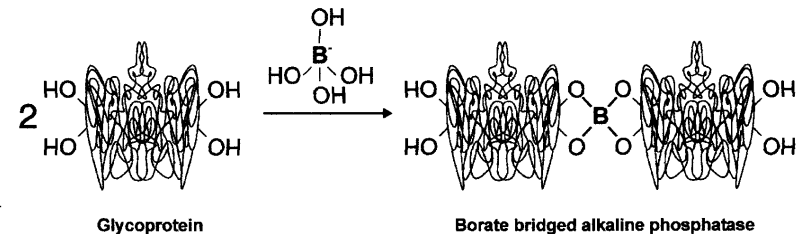


Fig. 6. Proposed borate-bridged alkaline phosphatase oligomers.

Balzamování



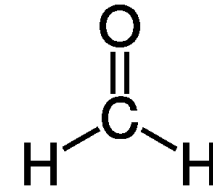
20. a 21. století



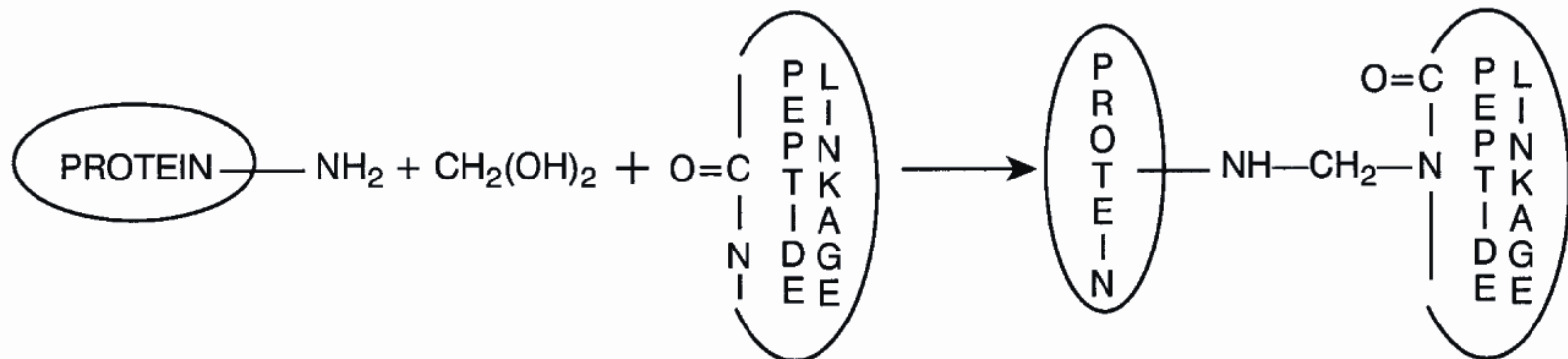
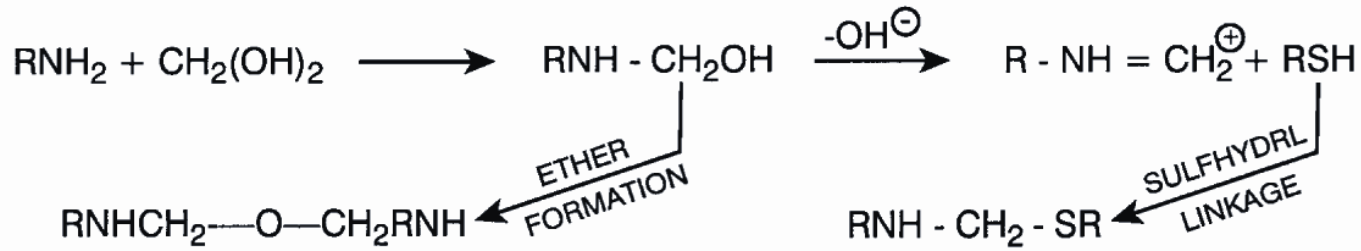
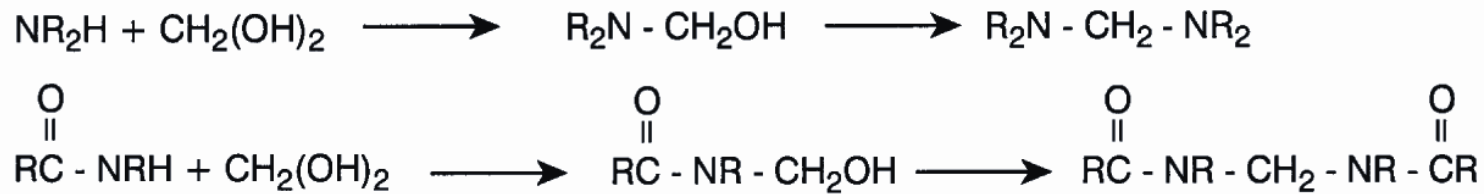
19. století (občanská válka v USA)



Reakce s formaldehydem



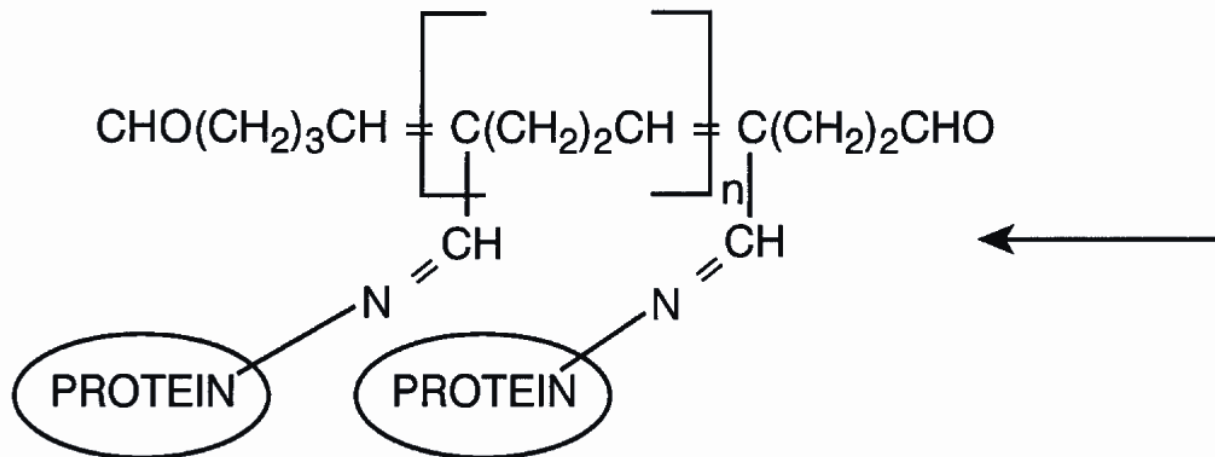
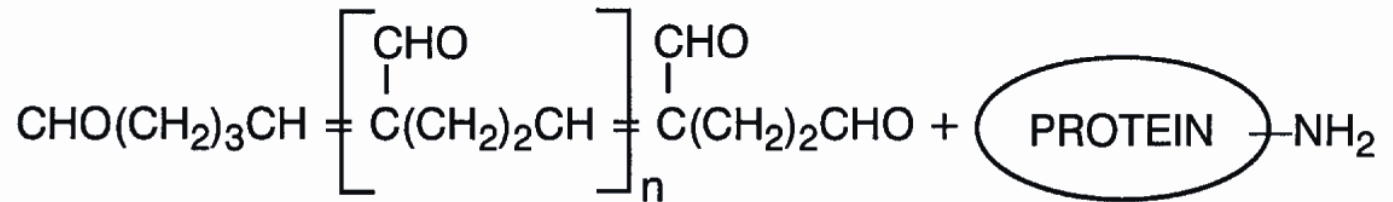
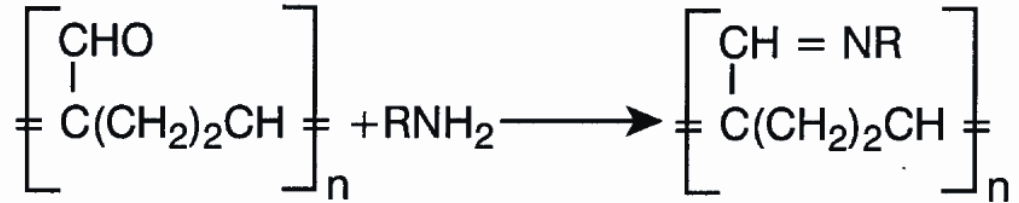
Reakcí volné aminoskupiny proteinu s formaldehydem vzniká Schiffova báze. Tato reakce se uplatňuje při konzervaci anatomických preparátů formalínem (35-40 % vodný roztok formaldehydu). Též balzamace (USA)



Galalit (umělá rohovina) byl objeven roku 1897 a v roce 1899 patentován Adolphem Spittelerem a Wilhelmem Krischem. Roku 1900 byl předveden na pařížské světové výstavě. Říká se, že na počátku všeho byla kočka zapomenutá v laboratoři, která převrhla láhev s formalínem do své misky s mlékem. Pravděpodobnější je pokus o využití konzervačních vlastností formalínu proti degradaci kaseinové hmoty. Tento materiál znamenal převrat v knoflíkářském průmyslu možností různých strukturálních efektů a možností imitovat celou řadu materiálů: rohovinu, želvovinu, slonovinu, dřevo, apod. Ve 30. letech byl rovněž používán při výrobě šperků, per, držadel deštníků, kulečnickových koulí a kláves (nahradil slonovinu), aj. Galalit je nehořlavý a dá se snadno leštit. Svoji porozitou je ideální pro barvení. Nelze ho tavit, vyrábí se ve formě desek a trubek k mechanickému opracování.



Reakce s glutaraldehydem



„Lidé z bažin“

Tvorná Schiffových bází s 5-KMA

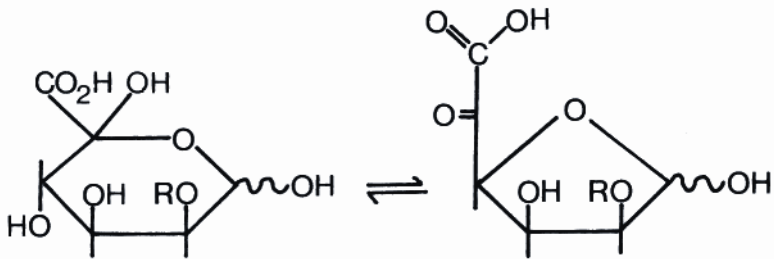


Fig. 6. 5-Keto-D-mannuronic acid (5 KMA) in its hemiketal (pyranose) ring form and its highly-reactive keto- (furanose) ring form. In sphagnum, both forms are glycosidically linked through positions 1 and 2, and some of the pyranose units are additionally linked through position 5 (Painter, 1983a, 1998; Andresen et al., 1987).



Muž z Grauballe (Dánsko)

„Lidé z bažin“



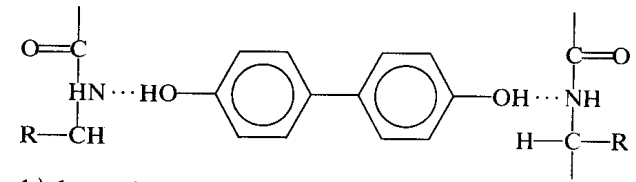
Muž z Tollundu (Dánsko)

Muž z Lindow (Velká Británie)

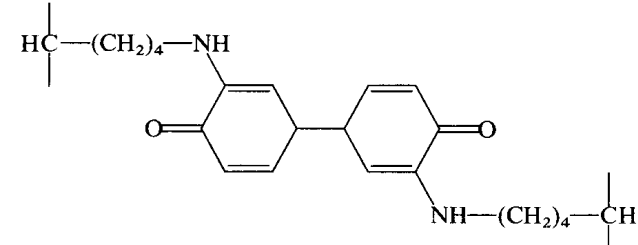


Třísloviny

a) vodíková vazba



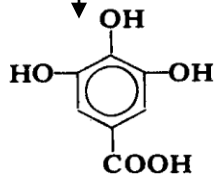
b) kovalentní vazba



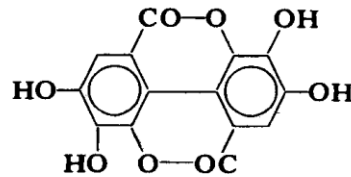
Vázání tříslovin probíhá hlavně interfibrilárně.

Hydrolyzovatelné: H-můstky

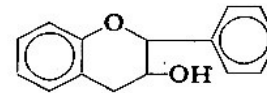
Kondenzované: kovalentní vazba



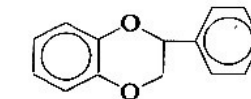
kyselina galová



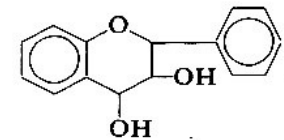
kyselina elagová



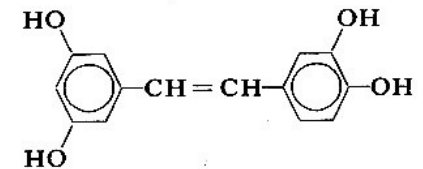
flavan-3-ol



flavón



flavan-3,4-ol

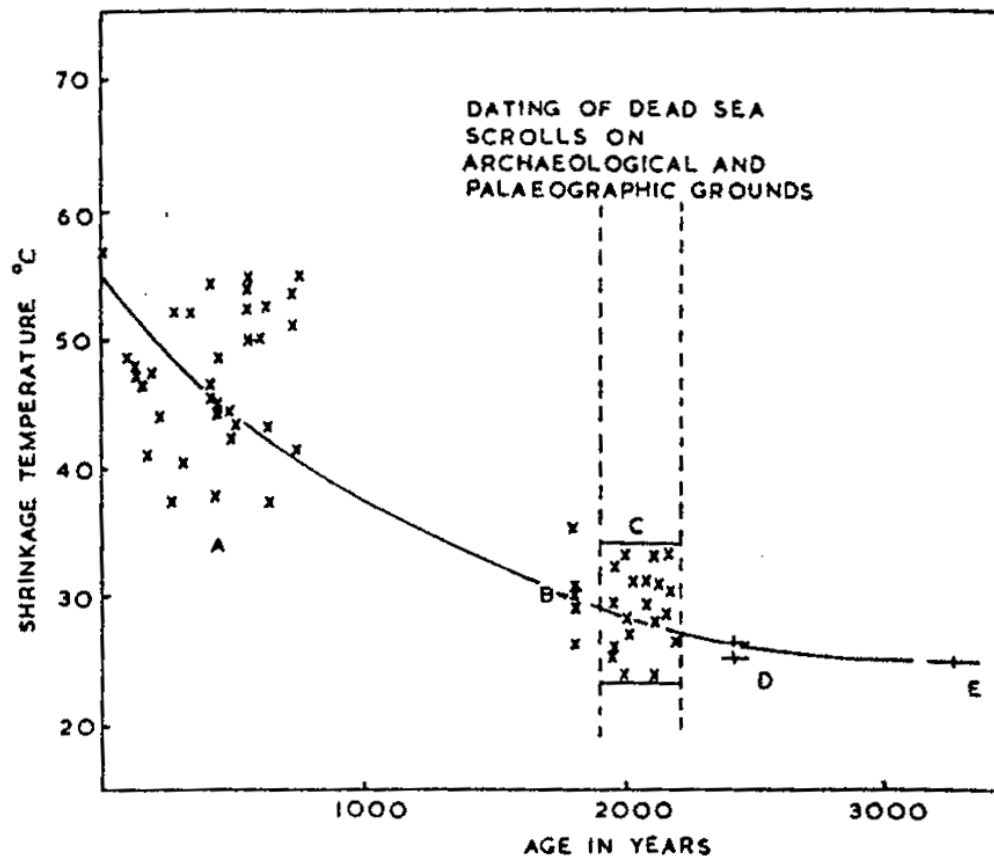


hydroxystilbén

Datování pergamenových svitků

Teplota smrštění

= teplota při níž dochází ke zkracování kolagenových vláken. Závisí na způsobu činění a stáří pergamenu



A: anglické pergameny (1193-1955 AD)

B: pergameny z jeskyní Vádí Murabba'at (2. židovské povstání, 132-135 AD)

C: fragmenty pergamenu z jeskyně 4, Kumrán

D: fragmenty egyptskoaramejského dopisu (5. stol. BC)

E: kožený pásek k upevnění sekerky, Egypt (1300 BC)

Maillardova reakce

= neenzymatická glykace

Potravinářství

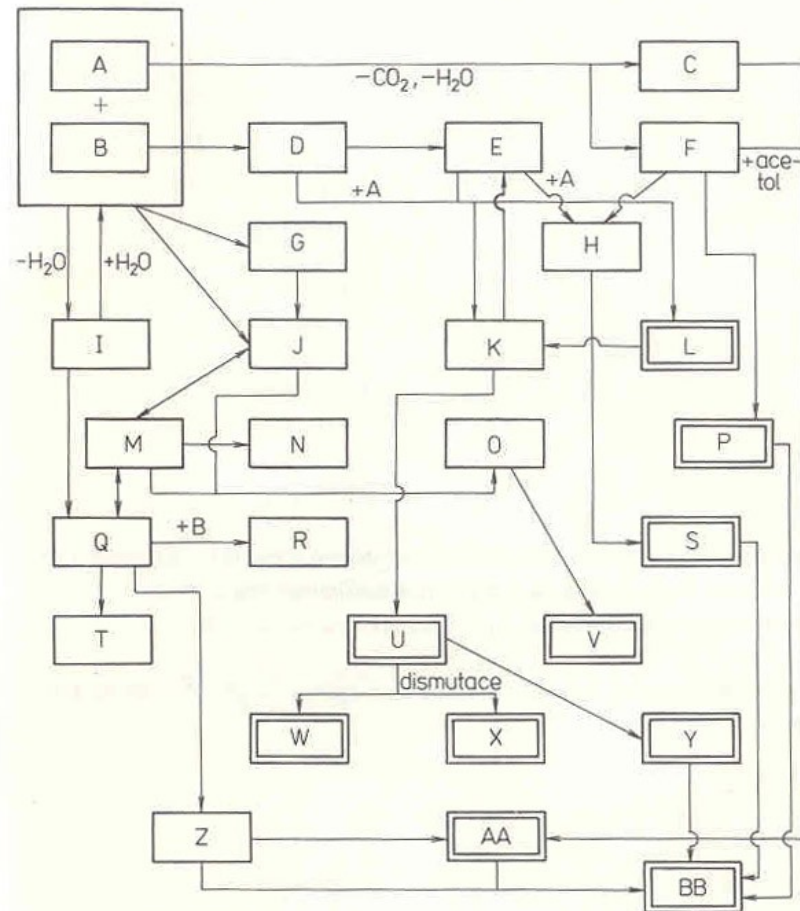
Medicína

„Molekulární paleontologie“

Nejvhodnější podmínky:

Vyšší hodnota pH

Nízká vlhkost



Obr. 46 Schéma Maillardových reakcí

A – D-aminokyselina; B – aldosa; C – dioxopiperaziny; D – dikarboxylové sloučeniny; E – 5-(hydroxymethyl)-2-furaldehyd; F – aminy; G – karbylaminy; H – Schiffova báze 5-(hydroxymethyl)-2-furaldehydu; I – aldoslaminokyselina; J – Schiffova báze; K – Streckerovo odbourávání; L – acetol a degradační produkty cukrů; M – enolformy acyklických aldoslaminokyselin; N – tautomer Schiffovy báze; O – alkylpyrrol; P – deriváty imidazolu; Q – deoxyoxosaminokyselina; R – disubstituovaná deoxyaminokyselina; S – deriváty furanu; T – N-(2-furoylmethyl)-aminokyselina; U – Streckerovy aldehydy; V – pyrrolové deriváty; W – alkoholy; X – kyseliny; Y – aldol; Z – fruktosaminy; AA – pyrazinové deriváty; BB – melanoidiny aj. polykondenzáty

Maillardova reakce

Kondenzace cukru s aminem

Amadoriho přesmyk
(glykosylamin na ketosamin)

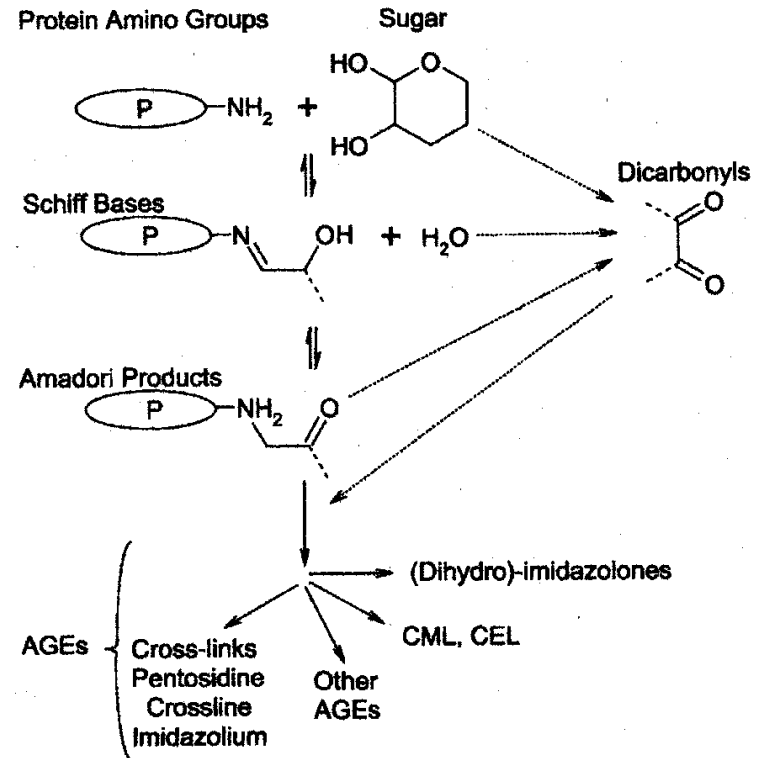
Dehydratace cukrů

Fragmentace cukrů

Streckerovo odbourávání

Aldolová kondenzace

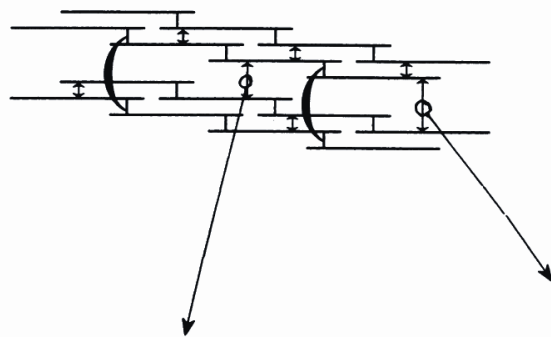
Aldehyd-aminová kondenzace



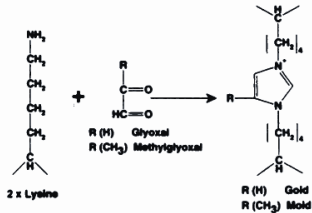
Scheme 2. Pathways of non-enzymatic glycation. Physiological concentrations of monosaccharides can react with protein amino groups. Some of the most prevalent products of these covalent reactions is the formation of (dihydro) imidazolones by the reaction of 3-deoxyglucosone or methylglyoxal with Arg, generation of *N*-carboalkyl derivatives of Lys as *N*^ε-(carboxymethyl)lysine (CML), *N*^ε-(carboxyethyl)lysine (CEL) and pentosidine, crossline and imidazolium cross-links. They are formed via the so-called Maillard reaction, where the ε-amino group of Lys or the amino acid terminus of a protein reacts with a reducing sugar. The formation proceeds via oxidative cleavage of Schiff bases or Amadori products, or from dicarbonyl compounds under non-oxidizing conditions. Broken lines represent attachment of the residue to the peptide backbone and large ellipses symbolize protein.

Příčné můstky „crosslinks“)

GLYCATION CROSS-LINKS



(a)



(b)

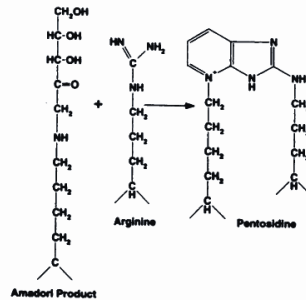
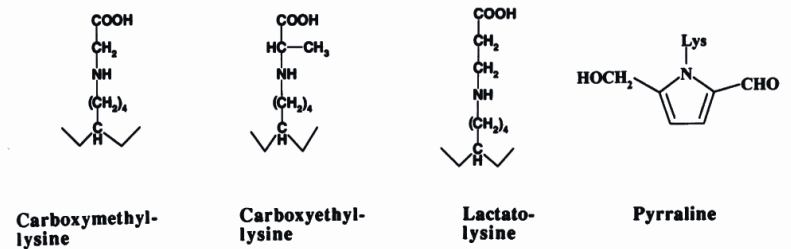


Fig. 7. Glycation-induced intermolecular cross-linking and suggested possible locations linking molecules through the triple helical regions, in contrast to the telopeptide regions involved in enzymic cross-linking. (a) Putative imidazolone cross-links derived from lysine and glyoxal (GOLD). (b) Pentosidine cross-link from ribose, lysine and arginine.

(a) LYSINE SIDE-CHAIN MODIFICATIONS



(b) ARGININE SIDE-CHAIN MODIFICATIONS

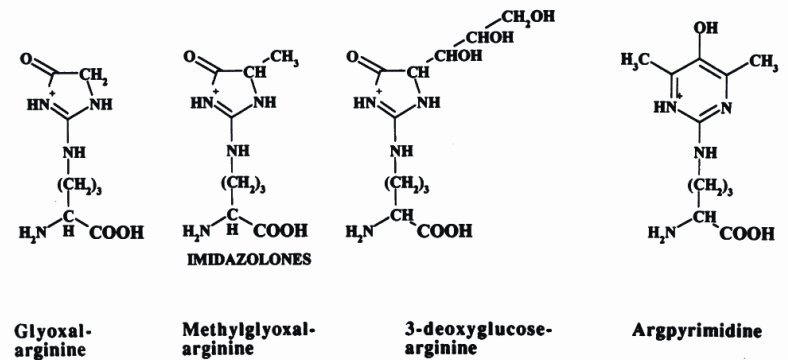


Fig. 8. Reactions of glucose and its metabolites, glyoxal, methylglyoxal and 3-deoxyglucosone with (a) lysine and (b) arginine in the formation of non-cross-linking AGEs. The consequent alteration of the charge profile of the collagen and elastin molecules leads to changes in the cell-matrix interactions.

Pentosidin

AGE „advanced glycation endproducts“

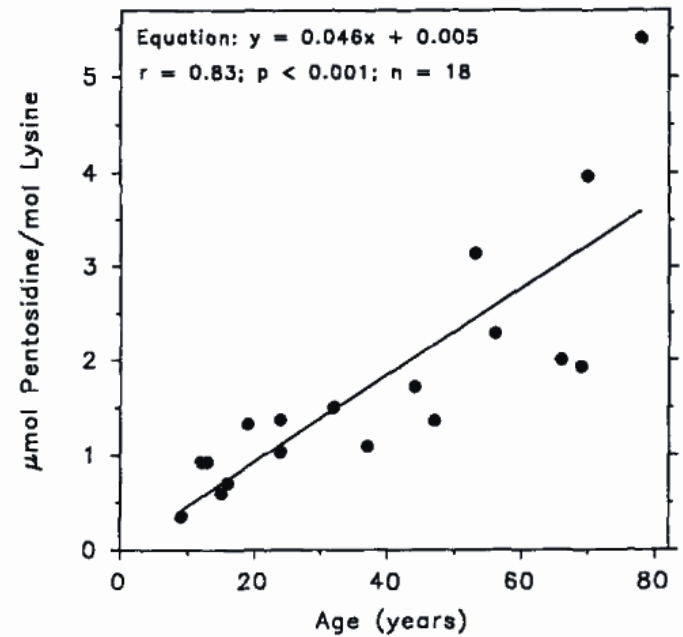


Figure 8. Age-dependent accumulation of pentosidine in human lens proteins.

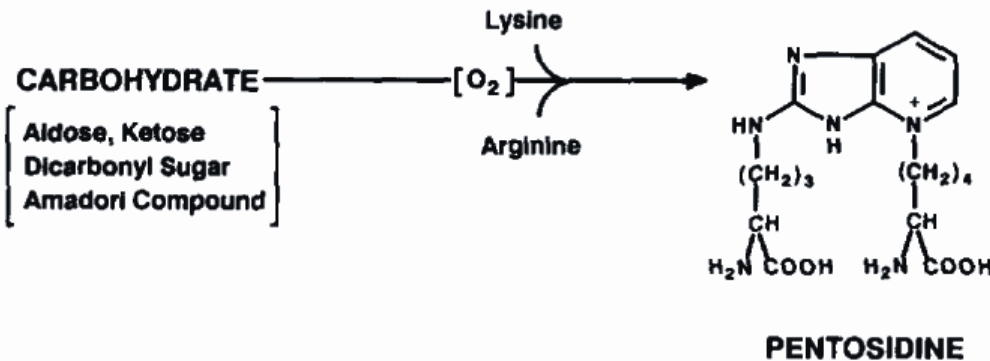


FIG. 1. Generalized pathway for formation of pentosidine. In addition to arginine and lysine, this scheme includes several possible carbohydrate precursors of pentosidine identified in this study. Oxygen is required for the formation of pentosidine from these precursors.

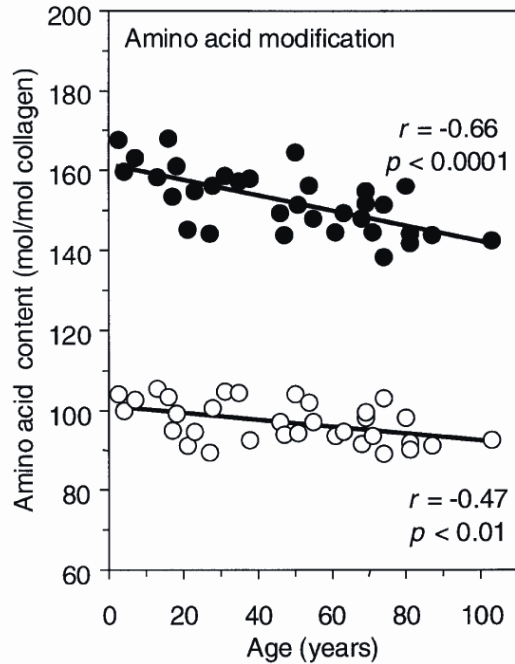


Figure 3 Arginine and (hydroxy-)lysine content of articular cartilage collagen decrease with age

Arginine (●) and (hydroxy-)lysine (○; sum of hydroxylysine and lysine) content of cartilage collagen as a function of age. Normal full-depth femoral condylar cartilage of 33 subjects in the age range 2.5–103 years was analysed; data are expressed as mol of residues/mol of collagen, assuming 300 hydroxyproline residues per triple helix. Linear regression analysis was performed on all data.

fructose-lysine (FL)
 N^{ϵ} -(carboxymethyl)lysine (CML)
 N^{ϵ} -(carboxyethyl)-lysine (CEL)
 pentosidine

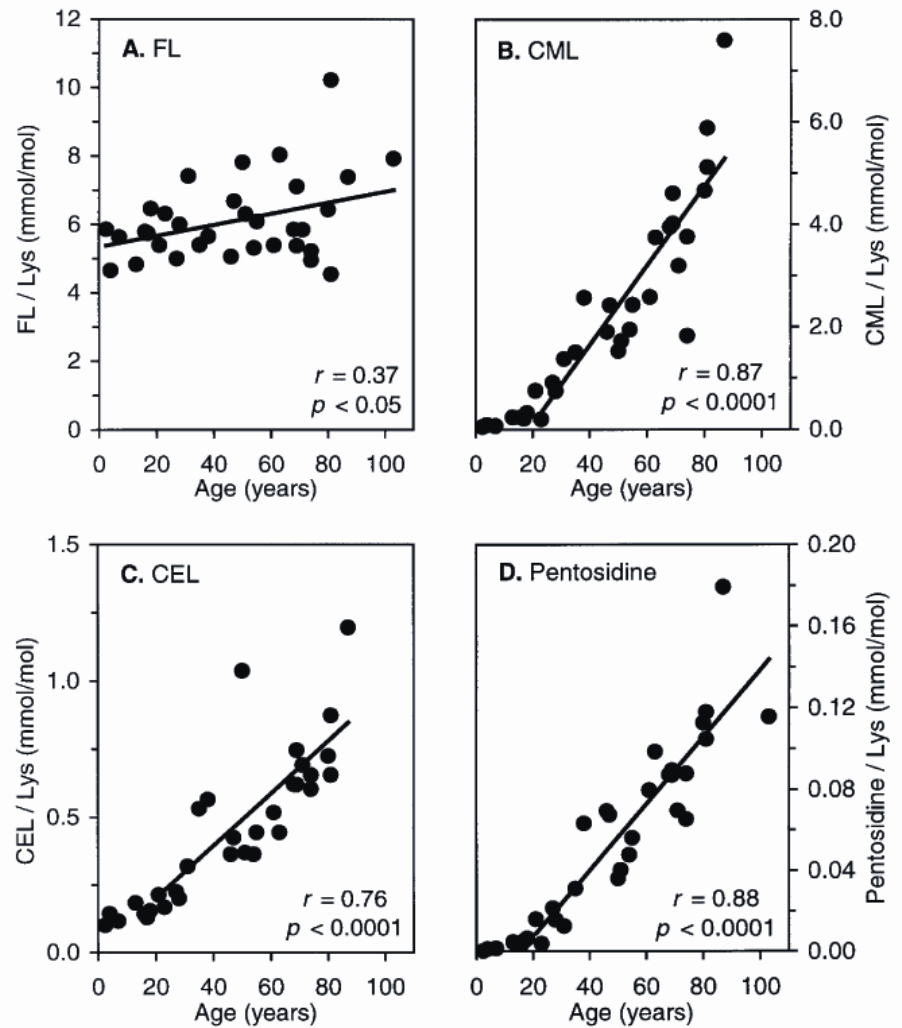


Figure 1 AGEs in articular cartilage collagen increase markedly with age

(A) Levels of the initial glycation product FL in cartilage collagen; (B–D) levels of the AGEs CML, CEL and pentosidine in cartilage collagen as a function of age. Normal full-depth femoral condylar cartilage of 33 subjects in the age range 2.5–103 years was analysed; data are expressed as mmol of residues/mol of lysine. Linear regression analysis was performed on all data for FL and on data > 20 years for CML, CEL and pentosidine.

Maillardova reakce

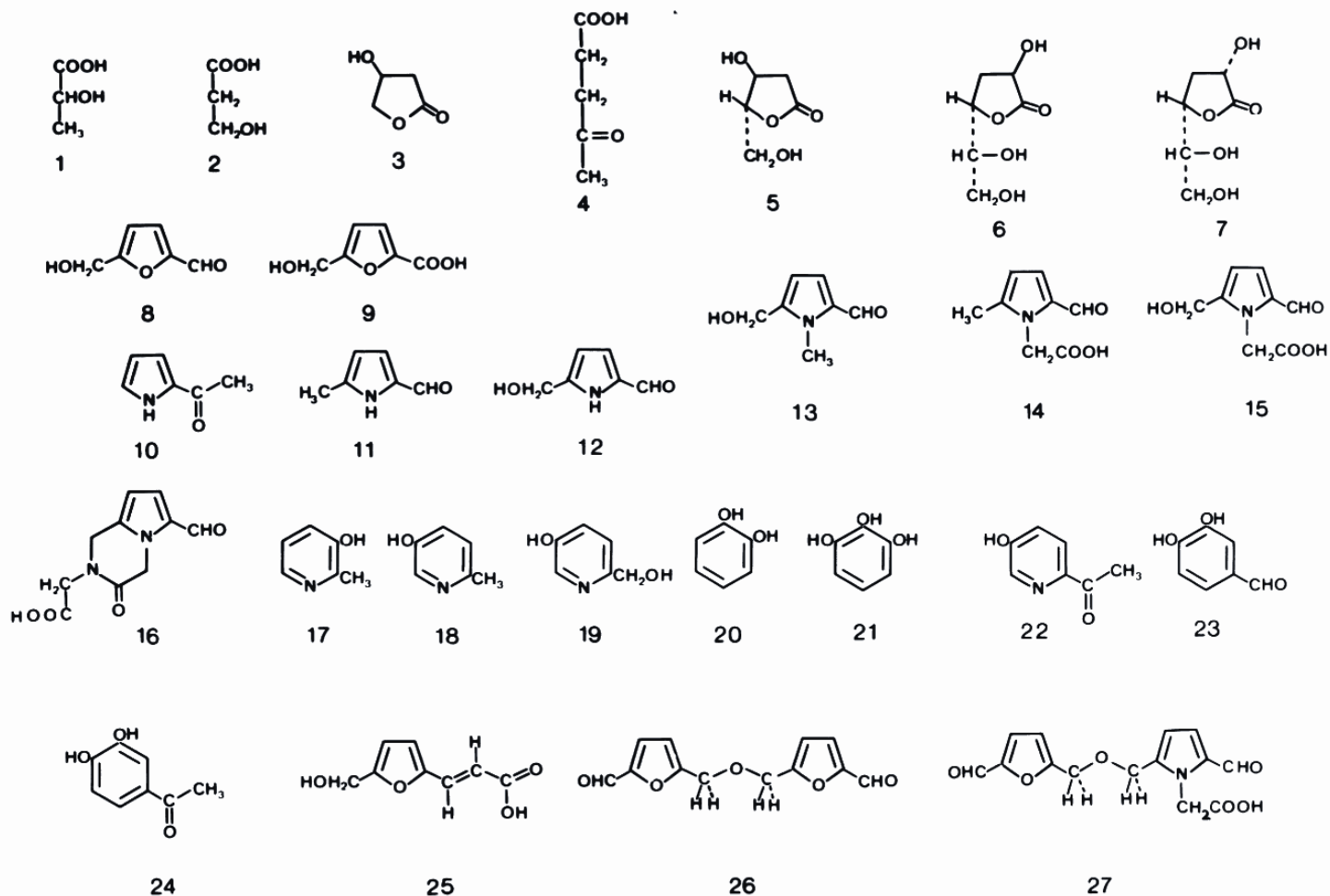


Fig. 3. Compounds identified as intermediates in the Maillard reaction between D-glucose and glycine under mildly acidic conditions (Olssen et al., 1978).

Maillardova reakce

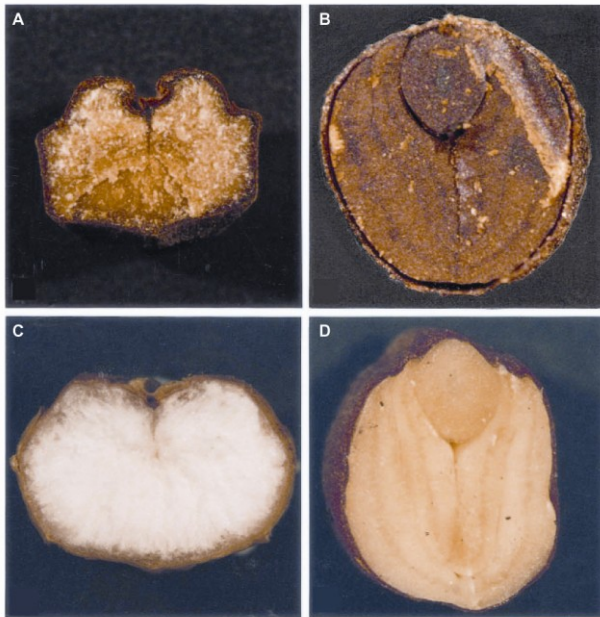


Fig. 1. Light microscope photographs of cross sections cut through the ancient propagules from Qasr Ibrim, *Hordeum* sp. (A) and *Raphanus sativum* (B), compared with those of their modern counterparts (C and D). The shrinkage of the ancient specimens, most evident in (A), is the result of desiccation. The darkening of the internal storage tissues provides visible evidence of biomolecular decay through the Maillard or browning reaction. Evidence for this reaction occurring within the propagules comes from the characteristic volatile compounds released upon crushing and shown in Fig. 2.

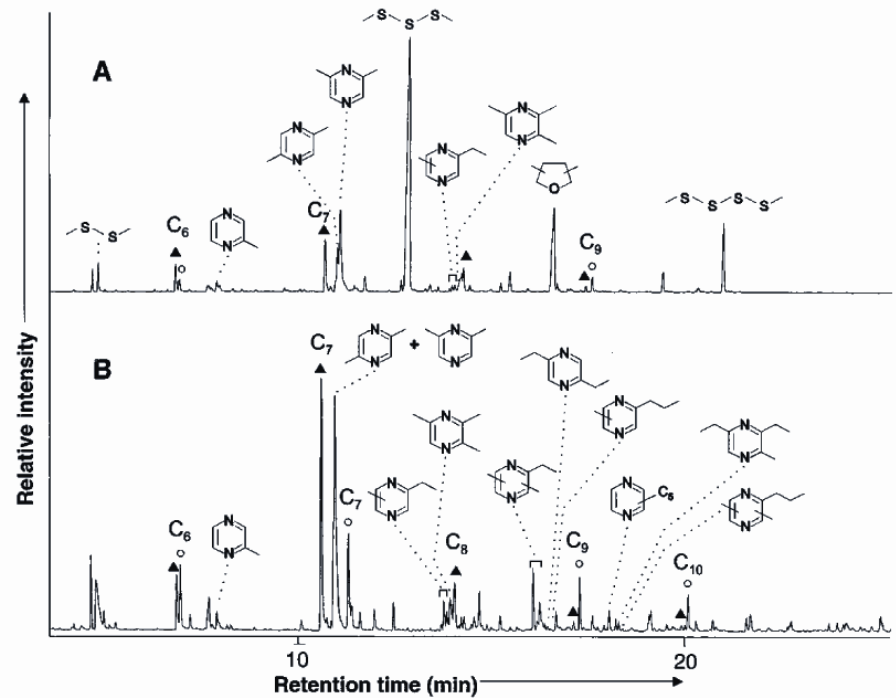


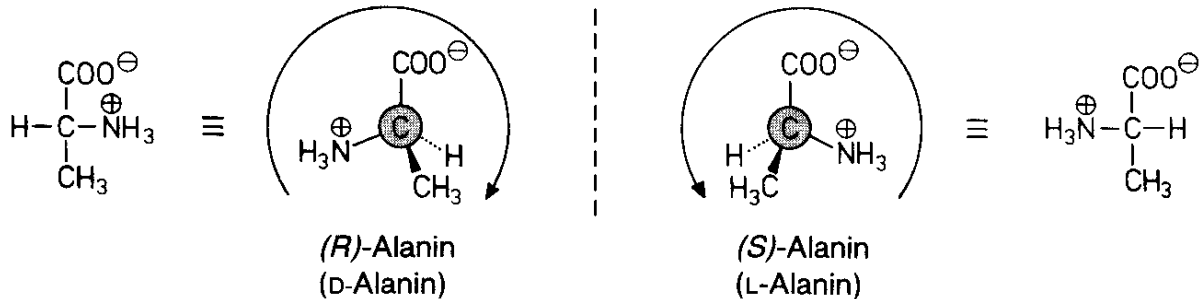
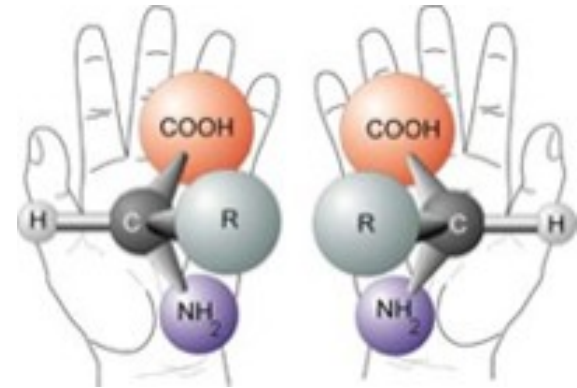
Fig. 2. Partial desorption headspace GC-MS total ion chromatograms for the volatile compounds trapped in the ancient propagules (A) radish (*Raphanus sativum*) and (B) barley (*Hordeum* sp.). The structures of the alkyl pyrazines and alkyl polysulfides, characteristic of the Maillard reaction and referred to in the text, are shown adjacent to the peaks on the chromatogram. The range of aliphatic carbon compounds (annotated on the chromatograms with their chain length) refers to alkan-2-ones (▲) and *n*-alkanals (○) formed through lipid oxidation.

Racemizace aminokyselin

Spontánní

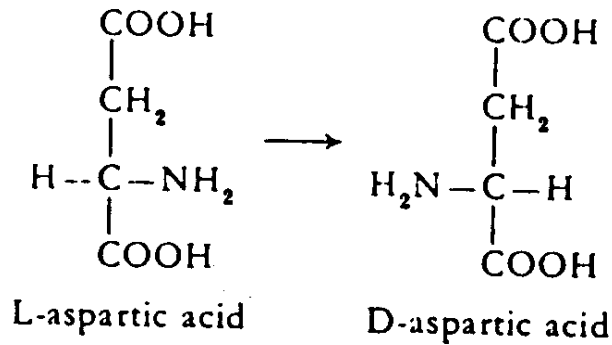
Indukovaná UV, Rtg a γ -zářením

Enzymatická (racemáza a epimeráza) -
mikroorganismy

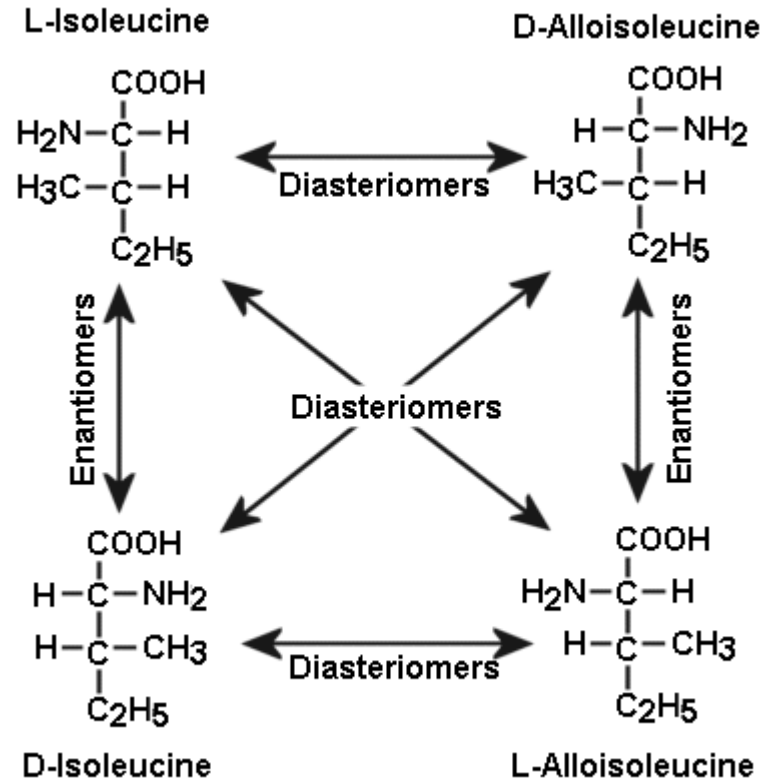


Racemizace

Počet chirálních center



$$\ln\left\{\frac{1 + D/L}{1 - K \cdot D/L}\right\} - \ln\left\{\frac{1 + D/L}{1 - K \cdot D/L}\right\}_{t=0} = (1 + K)k_i t$$



Spontánní racemizace

In vivo (tkáně s pomalým metabolickým obratem)

Post mortem

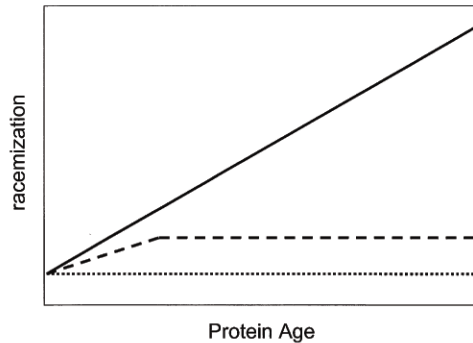
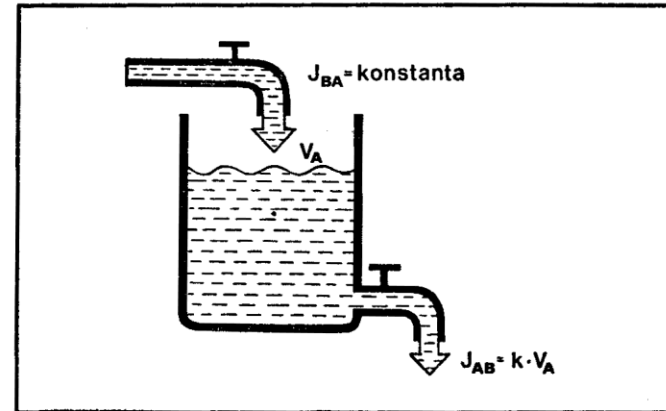


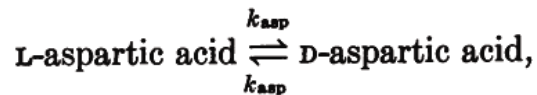
Fig. 3. Estimation of in vivo lifetimes of proteins based on the relationship between age and the extent of aspartic acid racemization: Proteins with high turnover (dotted line) do not exhibit an accumulation of modified D-aspartic acid residues with age. Proteins with longer half-life and low turnover (dashed line) can exhibit an accumulation of D-aspartic acid that is not strictly age-dependent because of the existing turnover. An equilibrium between accumulated D-aspartic acid residues and L-aspartic acid residues of newly synthesized proteins may result in elevated D-aspartic acid concentrations at a constant level. Only in permanent proteins without any turnover (solid line) the concentration of D-aspartic acid increases with age in a predictable manner.



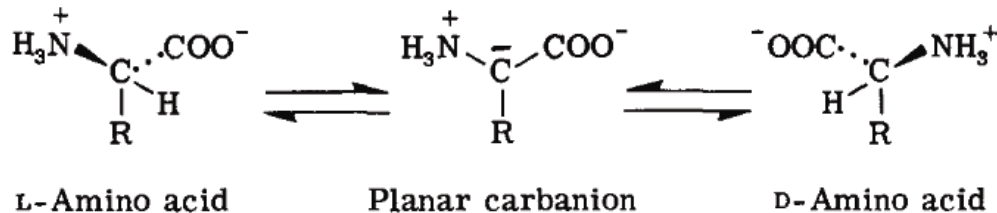
Rovnovážný stav tekutiny ve vodní nádrži můžeme vypočítat velmi snadno. Příslušné veličiny a vztahy: J_{BA} – rychlost přítoku (zde je konstantní), J_{AB} – rychlost odtoku, V_A – objem vody v nádrži, k – konstanta odtoku.

Spontánní racemizace

$$-\frac{d(L)}{dt} = k_L(L) - k_D(D)$$



$$\ln\left(\frac{1 + D/L}{1 - D/L}\right)_t = \ln\left(\frac{1 + D/L}{1 - D/L}\right)_{t=0} + 2k_L t$$



SCHEME 1. The mechanism of amino acid racemization showing the formation of the carbanion intermediate. Base abstracts the α -proton; this is the rate-limiting step in the reaction. Readdition of the proton occurs by the reaction of water with the carbanion. This mechanism is applicable to both free and peptide-bound amino acids.

Spontánní racemizace

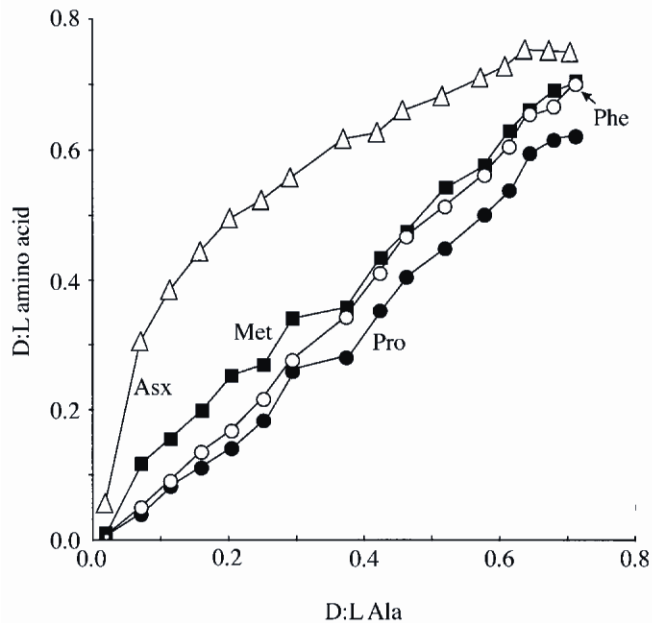


Figure 1. Comparative rates of racemization for different amino acids from mollusc shells during artificial diagenesis plotted against D:L ratio of alanine (Ala). Note that unlike methionine (Met, solid squares), proline (Pro, solid circles) and phenylalanine (Phe, open circles), the rate of increase of Asx (Δ) is not linear with respect to Ala, but is distorted by a rapid initial phase (data from Goodfriend & Meyer (1991)).

In Vivo RACEMIZATION OF SERINE AND ASPARTIC ACID IN DENTIN AND THE OCULAR LENS NUCLEUS IN HUMANS

Age (years)	D/L Ser	D/L Asp ^a
Dentin		
8	0.06	0.020
30	<0.01	0.033
42	0.03	0.045
60	<0.03	0.060
Lens nucleus		
16	0.07	0.079
41	0.08	0.109

Note. The estimated uncertainty of the D/L Ser ratios is $\sim\pm 15-20\%$ while for the D/L Asp ratios it is $\pm 5-10\%$.

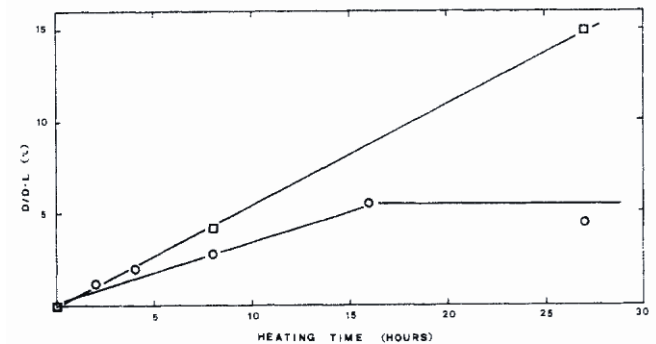


Figure 1. Formation of D-serine in chicken muscle (O) and BPA (□) heated at 121 °C.

Spontánní racemizace

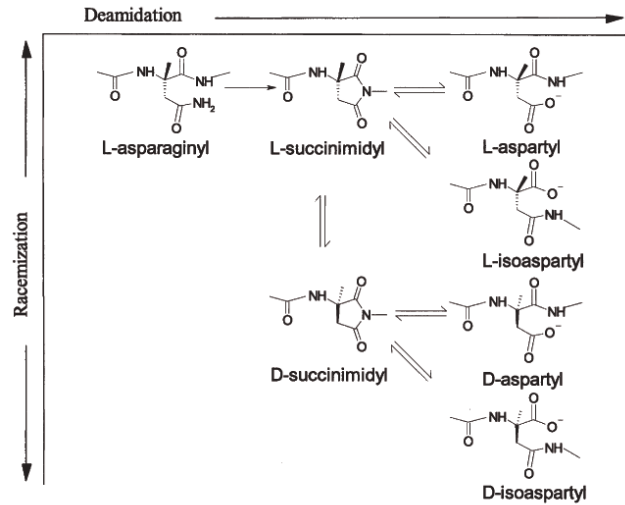


Figure 5. The conventional mechanism of the Asn racemization reaction at neutral or basic pH [16].

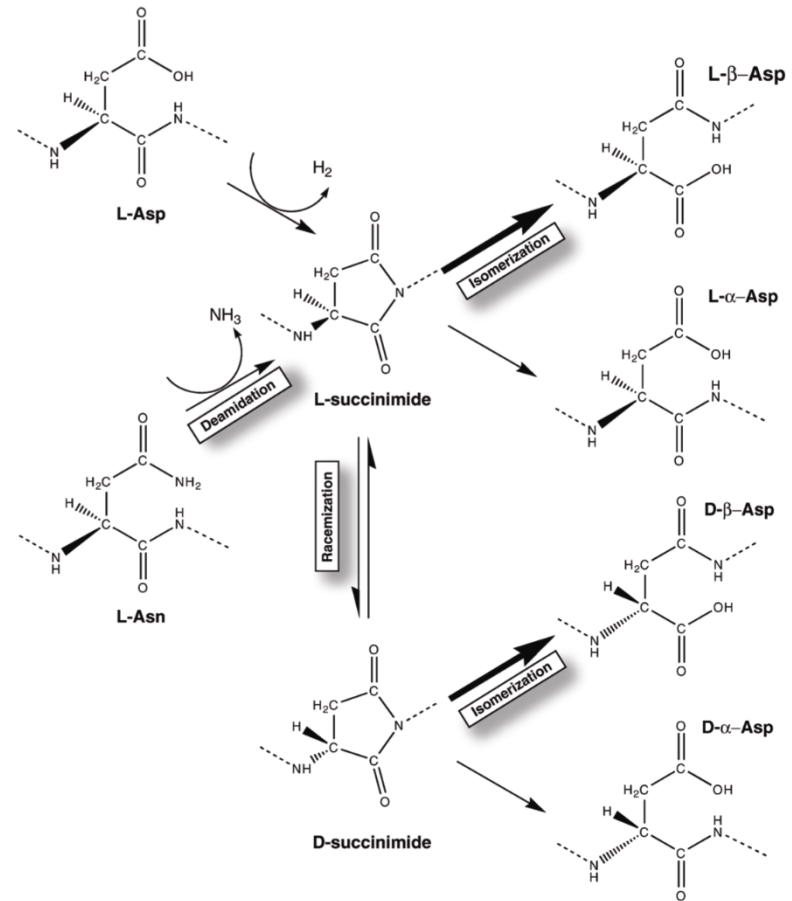


Fig. 1. Racemization, isomerization, and deamidation of peptide bonded aspartate (Asp) and asparagine (Asn) residues. Dehydration of Asp residues produces a succinimide intermediate, which can racemize and isomerize (labeled arrows). Isomerization results from hydrolysis of the succinimide ring below the cyclized nitrogen bond. Succinimide intermediates are ~2–3 times more likely to isomerize than reform the native α -Asp conformation [22] (bold arrows). Deamidation of Asn can also lead to formation of a succinimide intermediate and subsequent racemization and isomerization.

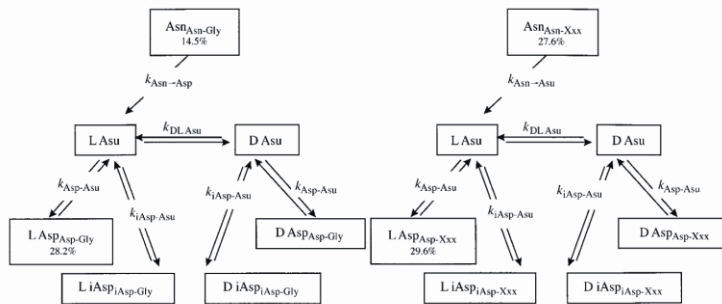
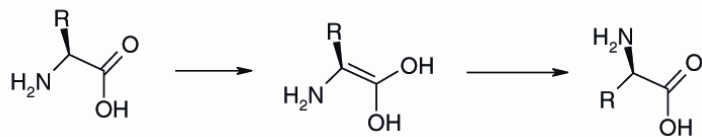


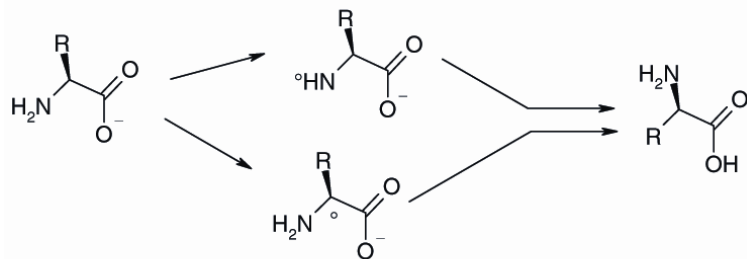
Figure 4. Model for racemization of Asx and decomposition of Asn as peptide-bound residues based upon Geiger & Clarke (1987). The model is divided into two components, the left-hand side represents fast racemizing Asx-Gly residues, which account for almost half of the residues in collagen. The right-hand side combines all the other residues in a "slow" fraction (see table 2). Kinetic parameters for deriving rate constants are given in table 3. Note that the model does not include hydrolysis of peptide bonds which will become a significant feature of Asx decomposition over archaeological time-scales.

Racemizace indukovaná zářením

UV
rtg
radioaktivní



Racemization through keto-enol mechanism



Racemization through a radical-anion mechanism during radiolysis

Table 1 Extent of aspartic acid racemisation in brunnescent cataracts

Age (yr)	D/L-aspartic acid	
	Expected*	Observed
57	0.127	0.203
76	0.150	0.296
77	0.151	0.268
80	0.155	0.283
89	0.166	0.262

*The expected ratios were calculated from equation (1) using the age of each individual.

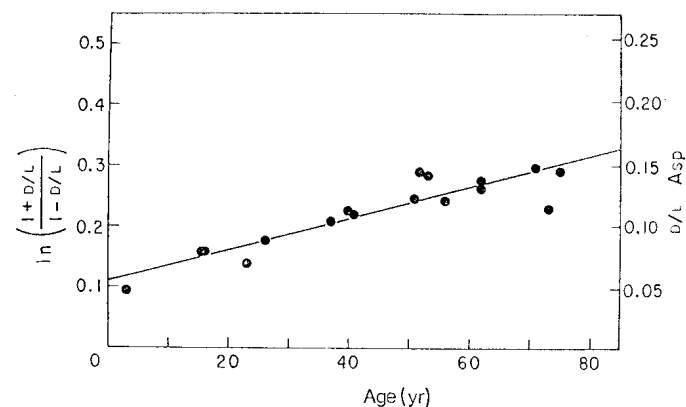


Fig. 1 Analysis of D/L-aspartic acid contents of central nucleus samples of 17 normal human lenses.

Enzymatická racemizace

Mikrobiální enzymy:

Racemázy

Epimerázy

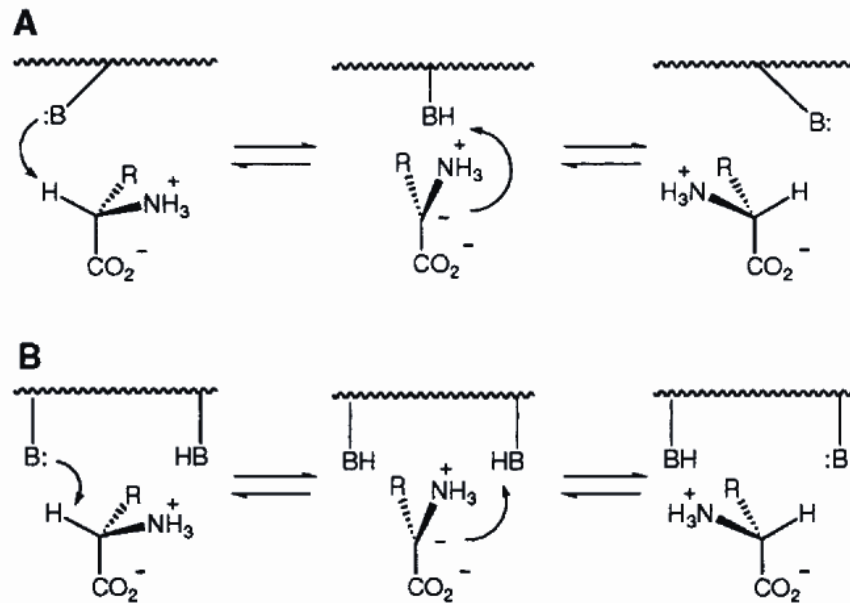


FIGURE 3. Mechanisms for amino acid racemization: (A) one-base mechanism and (B) two-base mechanism.

Možnost ovlivnění poměru DL saprofytními mikroorganismy !!

Enzymatická racemizace

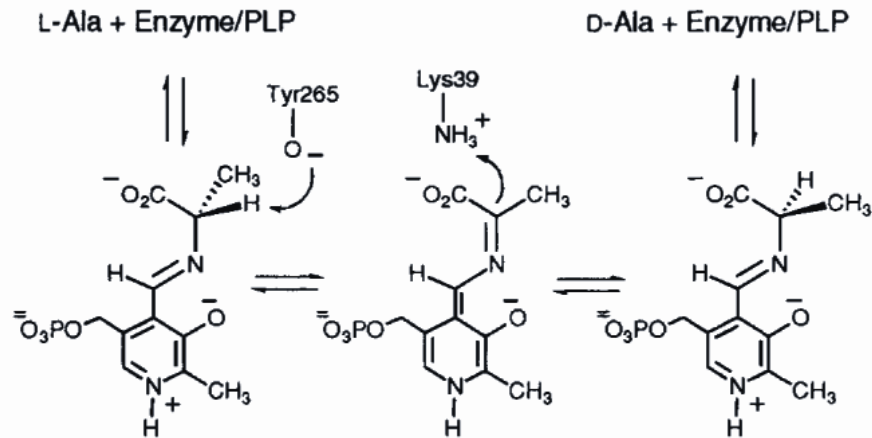


FIGURE 2. The mechanism employed by alanine racemase.

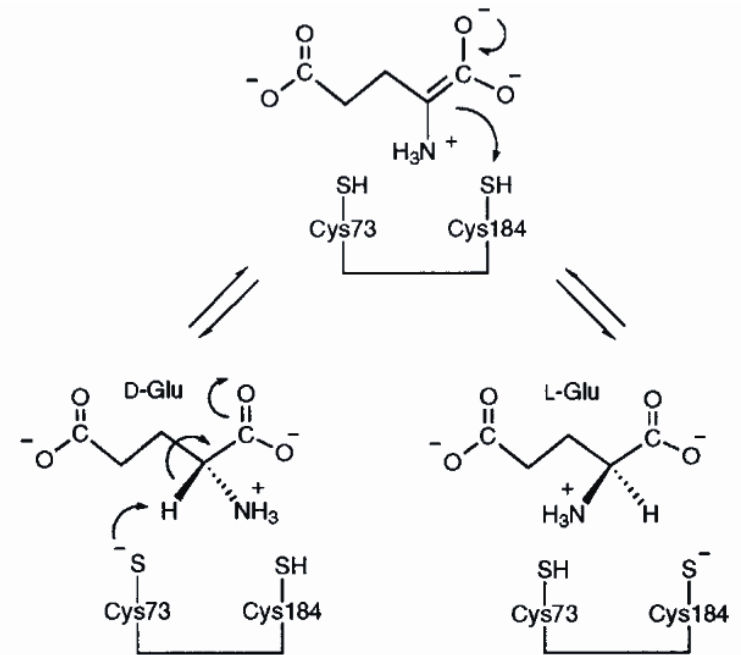


FIGURE 7. Mechanism employed by glutamate racemase.

Kontaminace

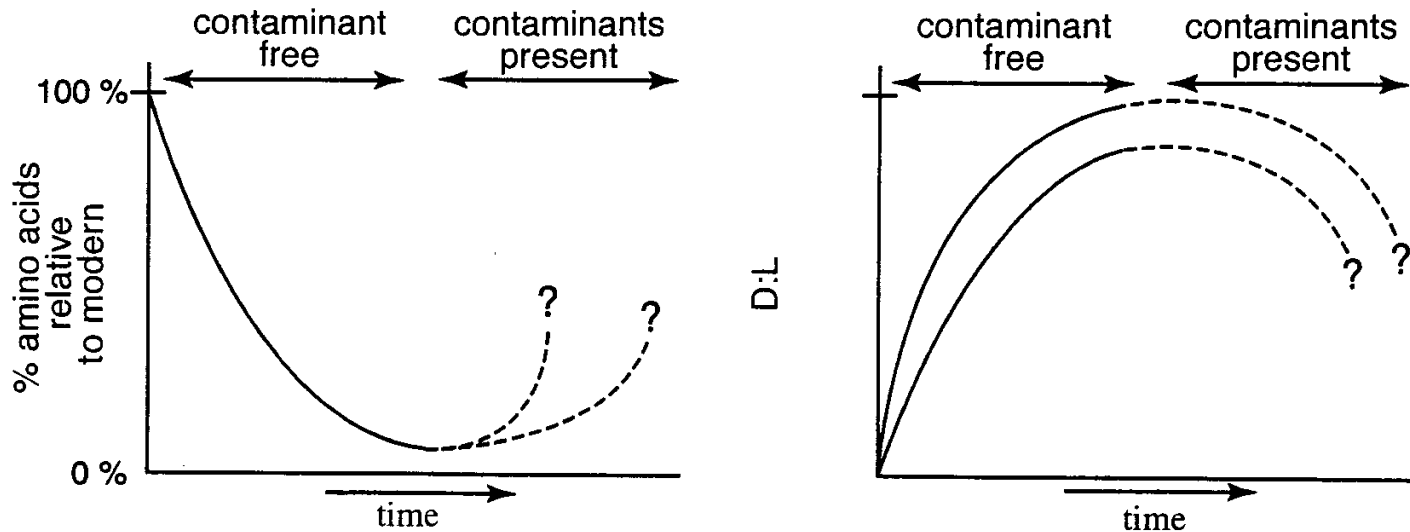


Figure 4. The effect of the various diagenetic reactions and processes shown in figure 3 on the amino-acid content (left) and the amino acid D:L ratios (right) of fossil specimens. In contamination-free samples, amino acids are steadily lost from the fossil matrix and the extent of racemization increases, eventually resulting in a racemic mixture. Contamination introduced into the fossil could result in an increase in the amino-acid content, and lower than expected D:L ratios. Well-preserved fossils would be expected to fall on the solid line, whereas those which are contaminated would fall on the dashed lines.

Faktory ovlivňující rychlost racemizace

Teplota

Voda

pH

Iontová síla

...

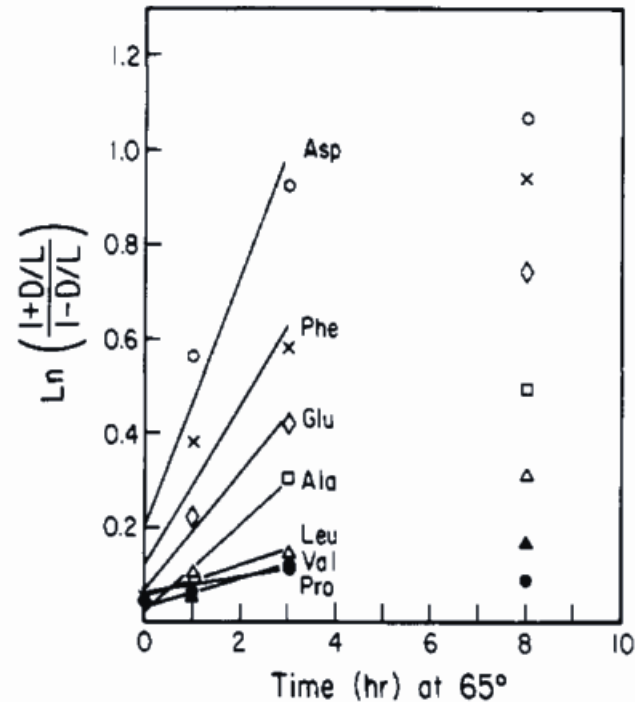


Figure 1. Time course of amino acid racemization reactions of casein in 0.1 N NaOH at 65 °C. The straight lines are constructed from the least-squares fit to the 0-, 1-, and 3-h points. (○) aspartic acid, (×) phenylalanine, (◇) glutamic acid, (□) alanine, (△) leucine, (▲) valine, (●) proline.

Přítomnost vody

V bezvodém prostředí racemizace téměř neprobíhá

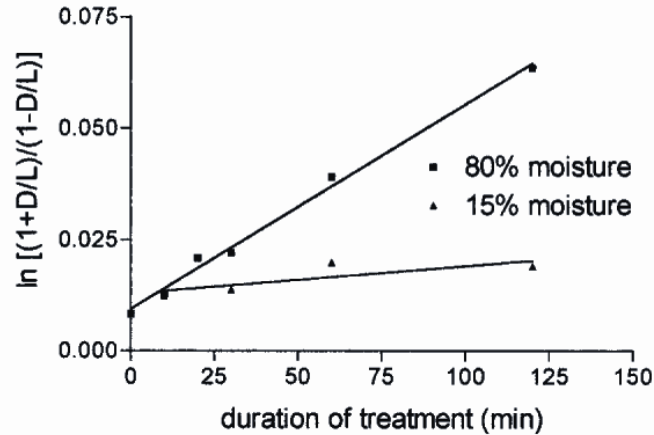


Figure 5. First-order rate plots for the racemization of aspartic acid in fish material treated at 95 °C, normal oxygen pressure, and pH 7.0 under different moisture conditions. The equations for the lines are $Y = 0.000062 + 0.000033X$ ($R^2 = 0.6413$) and $Y = 0.00046 + 0.00939X$ ($R^2 = 0.9929$) for 15% and 80% moisture, respectively.



Rancho la Brea (Kalifornie, USA) – anomálně nízké hodnoty epimerace isoleucinu (Ile) – bezvodé prostředí.

Vliv teploty

Arrheniova rovnice

$$\log k = \frac{E_a}{2.303 RT} + \log A$$

where k = rate constant at temperature, T
 E = energy of activation
 T = temperature in Kelvin
 A = collision factor

Natural log of k versus Reciprocal Temperature

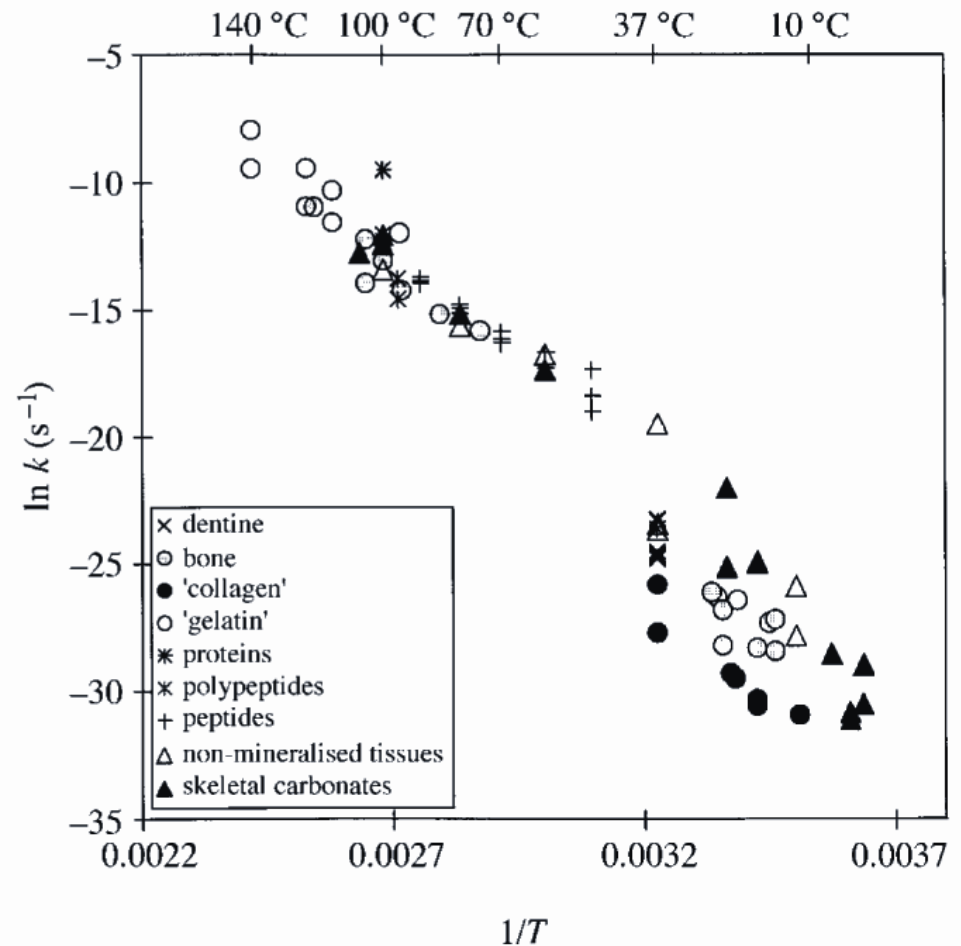
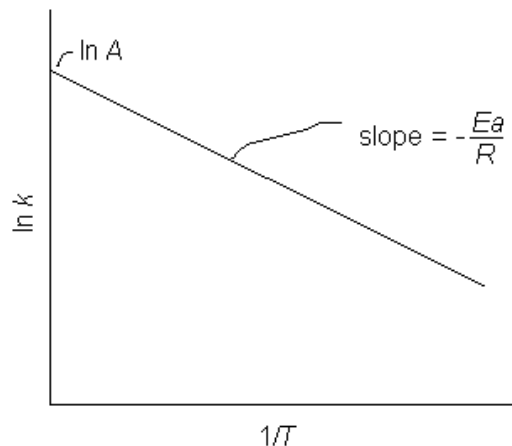


Figure 10. An Arrhenius plot of published kinetics of Asx racemization (data in Appendix A). Note that all experiments yield broadly similar rates and apparent activation energies at high temperatures but that (due to conformational constraints) the rates are slower at lower temperatures (<40 °C). This is particularly true of collagen in which Asu formation is severely restricted in the triple helix.

Vliv pH

Vliv deamidace

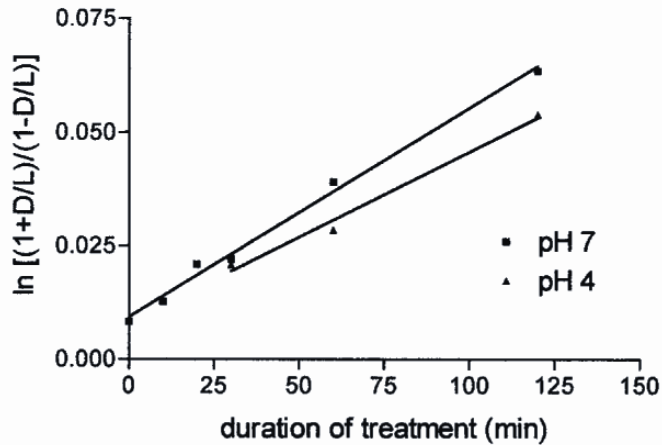


Figure 7. First-order rate plots for the racemization of aspartic acid in fish material treated at 95 °C, 80% moisture, and normal oxygen pressure under different pH conditions. The equations for the lines are $Y = 0.00037 + 0.00814X$ ($R^2 = 0.9878$) and $Y = 0.00046 + 0.00939X$ ($R^2 = 0.9929$) for pH 4.0 and pH 7.0, respectively.

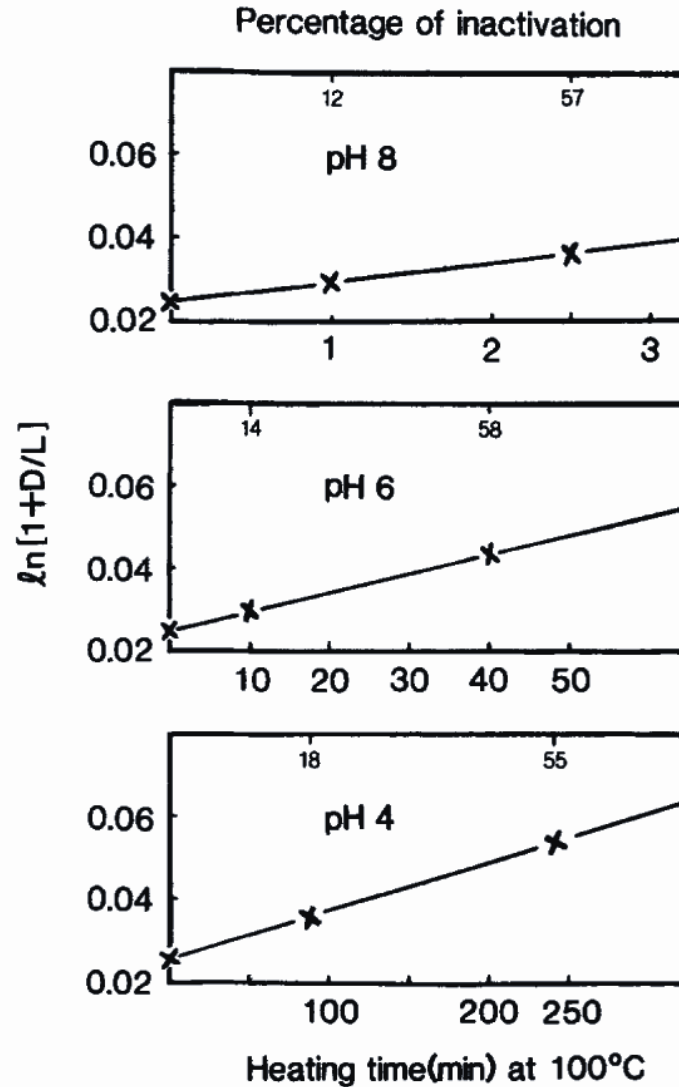


FIG. 1. Racemization kinetics of ASX in lysozyme incubated at 100°C at pH values of 4, 6, and 8. Also shown is the percentage of inactivation (upper horizontal axis) which occurred during incubation.

dentin

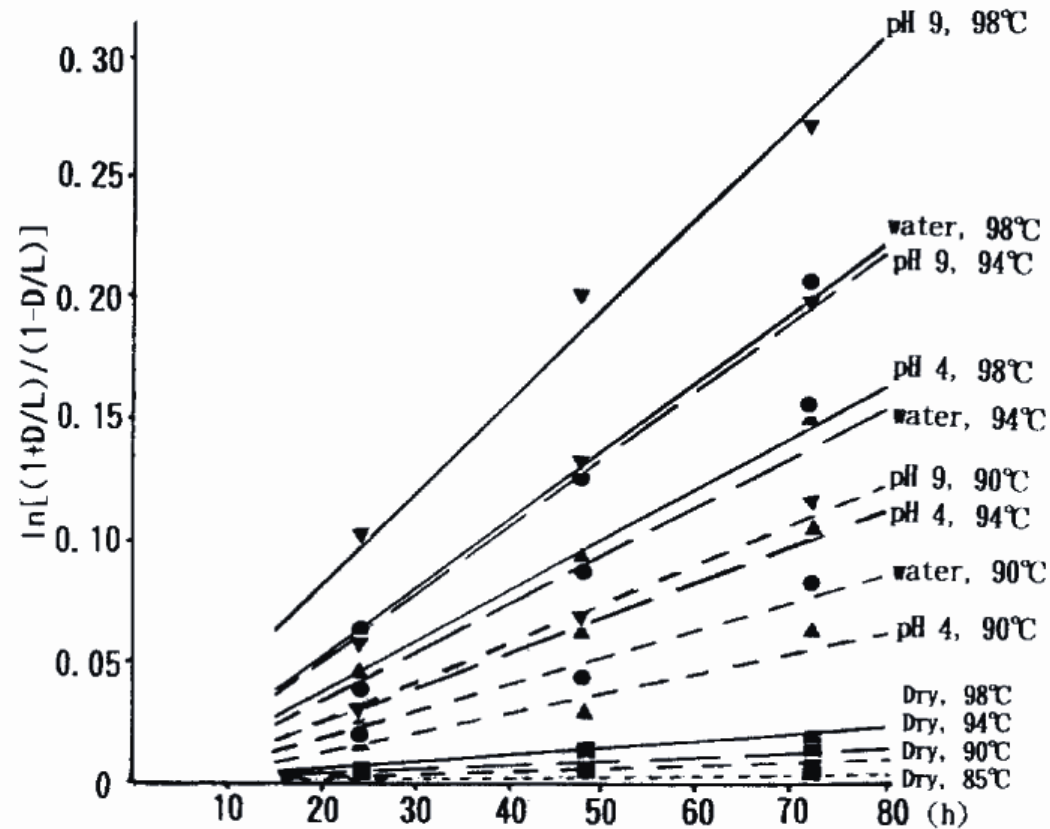


Fig. 1. Changes in the D/L ratio of aspartic acid caused by heating in each environment. ∇ , pH 9; \blacktriangle , pH 4; \bullet , water; \blacksquare , dry; \cdots , 90°C; $\cdots\cdots$, 94°C; $\cdots\cdots\cdots$, 90°C; $\cdots\cdots\cdots\cdots$, 85°C; pH 9, 98°C $\ln[(1 + D/L)/(1 - D/L)]_t = 0.003796t + 0.0103$; pH 9, 94°C, $\ln[(1 + D/L)/(1 - D/L)]_t = 0.002829t - 0.0039$; pH 9, 90°C $\ln[(1 + D/L)/(1 - D/L)]_t = 0.001625t - 0.0111$; pH 4, 98°C $\ln[(1 + D/L)/(1 - D/L)]_t = 0.00210t - 0.0055$; pH 4, 94°C, $\ln[(1 + D/L)/(1 - D/L)]_t = 0.001500t - 0.0092$; pH 4, 90°C $\ln[(1 + D/L)/(1 - D/L)]_t = 0.000827t - 0.0036$; water, 98°C $\ln[(1 + D/L)/(1 - D/L)]_t = 0.002867t - 0.0084$; water, 94°C $\ln[(1 + D/L)/(1 - D/L)]_t = 0.002008t - 0.0090$; water, 90°C $\ln[(1 + D/L)/(1 - D/L)]_t = 0.001133t - 0.0081$; dry, 98°C $\ln[(1 + D/L)/(1 - D/L)]_t = 0.00256t - 0.0001$; 94°C, $\ln[(1 + D/L)/(1 - D/L)]_t = 0.000163t - 0.0001$; dry, 90°C $\ln[(1 + D/L)/(1 - D/L)]_t = 0.000115t - 0.0001$; dry, 85°C; $\ln[(1 + D/L)/(1 - D/L)]_t = 0.000050t - 0.0007$, where t is the age of the dentin in hours.

Způsob uchování materiálu

Ethanol
Formalín
Neutrální formalín (pufrovaný)

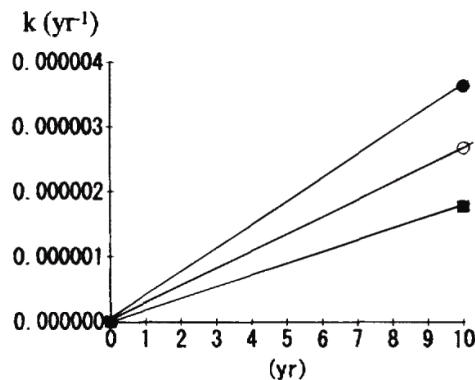


FIG. 2.—Comparison of racemization rates for dentin stored in each fixative. ●, 10% Neutral formalin; ○, 10% Formalin; ■, 95% Ethanol.

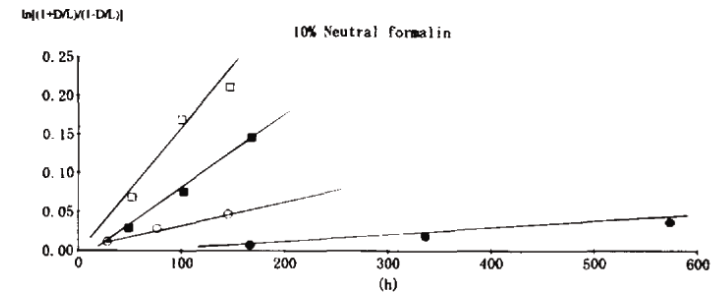
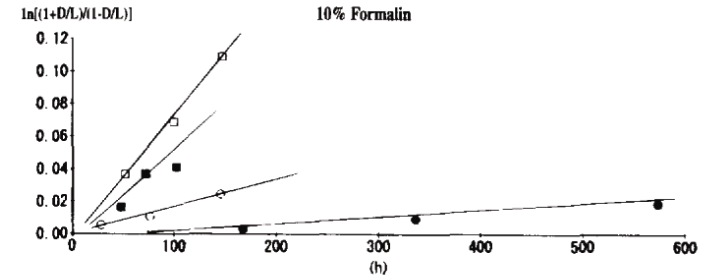
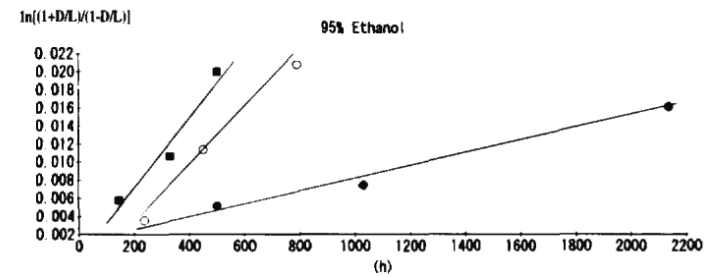


FIG. 1a), b), c)—Heating-related changes in the D/L ratio of dentinal aspartic acid. The formula of the rate of racemization and constant of rate (kh^{-1}) for the teeth stored in each fixative were calculated as follows: 95% Ethanol, ●, 68°C, $\ln[(1 + D/L)/(1 - D/L)]_t = 7.3370 \times 10^{-6}t + 5.0 \times 10^{-4}$, $k = 3.6680 \times 10^{-6}$; ○, 74°C, $\ln[(1 + D/L)/(1 - D/L)]_t = 2.7680 \times 10^{-5}t + 1.5 \times 10^{-5}$, $k = 1.3840 \times 10^{-5}$; ■, 77°C, $\ln[(1 + D/L)/(1 - D/L)]_t = 3.8347 \times 10^{-5}t + 1.8 \times 10^{-4}$, $k = 1.9173 \times 10^{-5}$. 10% Formalin, ●, 77°C, $\ln[(1 + D/L)/(1 - D/L)]_t = 3.9468 \times 10^{-5}t + 3.4 \times 10^{-3}$, $k = 1.9734 \times 10^{-5}$; ○, 85°C, $\ln[(1 + D/L)/(1 - D/L)]_t = 1.6820 \times 10^{-4}t + 2.7 \times 10^{-5}$, $k = 8.4100 \times 10^{-5}$; □, 90°C, $\ln[(1 + D/L)/(1 - D/L)]_t = 4.4426 \times 10^{-4}t + 1.2 \times 10^{-3}$, $k = 2.2213 \times 10^{-4}$; □, 95°C, $\ln[(1 + D/L)/(1 - D/L)]_t = 7.7236 \times 10^{-4}t + 5.6 \times 10^{-3}$, $k = 3.8618 \times 10^{-4}$. 10% Neutral formalin, ●, 77°C, $\ln[(1 + D/L)/(1 - D/L)]_t = 7.5500 \times 10^{-5}t + 5.2 \times 10^{-3}$, $k = 3.7750 \times 10^{-5}$; ○, 85°C, $\ln[(1 + D/L)/(1 - D/L)]_t = 3.0085 \times 10^{-4}t + 4.5 \times 10^{-5}$, $k = 1.5043 \times 10^{-4}$; ■, 90°C, $\ln[(1 + D/L)/(1 - D/L)]_t = 9.8792 \times 10^{-4}t + 2.1 \times 10^{-2}$, $k = 4.9396 \times 10^{-4}$; □, 95°C, $\ln[(1 + D/L)/(1 - D/L)]_t = 1.5032 \times 10^{-3}t + 1.2 \times 10^{-4}$, $k = 7.5160 \times 10^{-4}$, where t is the age of the dentin in hours.

Vliv vaření

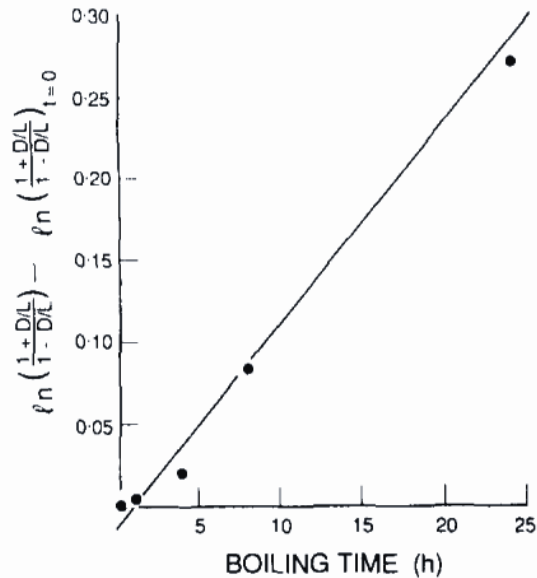


FIG. 2. Aspartic acid racemization in bone (deer) during boiling in water plotted in the form of reversible first order kinetics

Table 1. Inversion Rate Constants (k_{Asp}) and Half-Life Racemization Periods ($t_{1/2}$) for Fish Material Treated under Different Conditions

temp (°C)	moisture (%)	O ₂ pressure	pH	k_{Asp} (10^{-3} min^{-1})	$t_{1/2}$ (min)
95	80	normal	7.0	0.46	1510
120	80	normal	7.0	3.39	204
95	15	normal	7.0	0.06	11159
95	80	reduced	7.0	0.43	1613
95	80	normal	4.0	0.37	1848

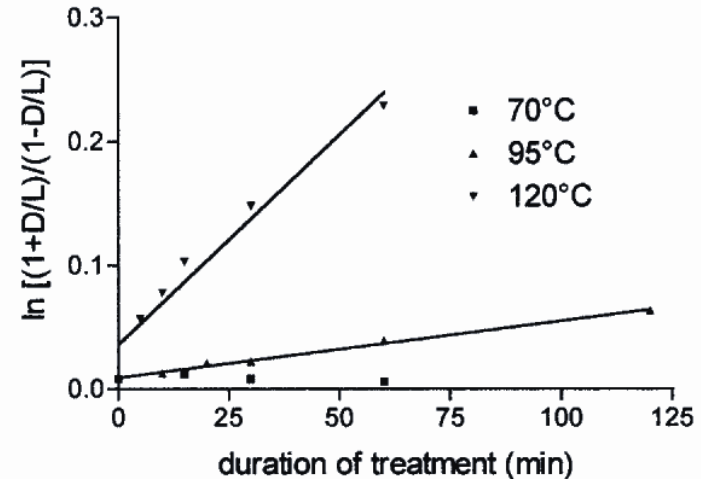
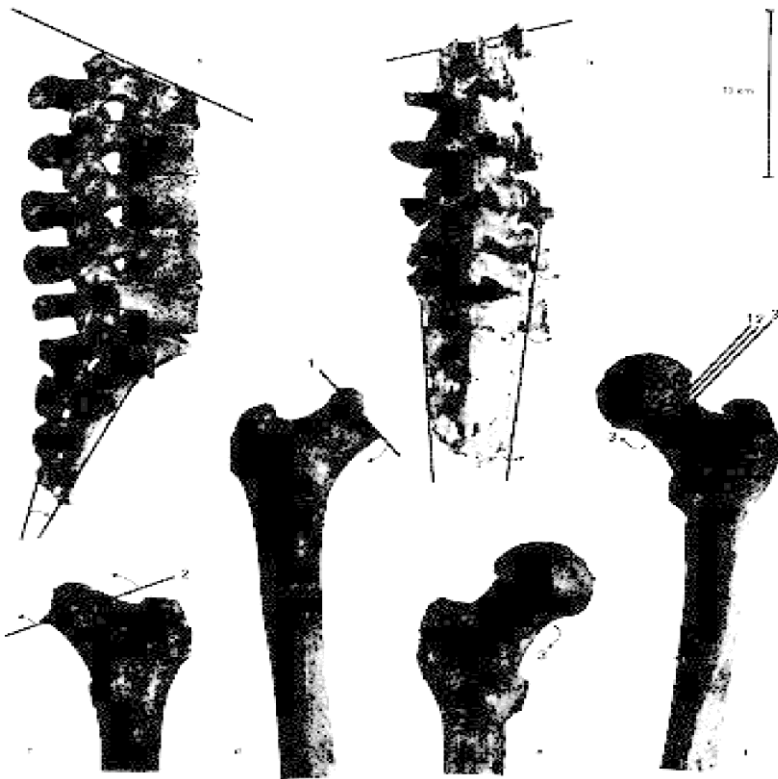


Figure 3. First-order rate plots for the racemization of aspartic acid in fish material at 80% moisture, normal oxygen pressure, and pH 7.0 under different temperatures. The equations for the lines are $Y = 0.00046 + 0.00939X$ ($R^2 = 0.9929$) and $Y = 0.00339 + 0.03578X$ ($R^2 = 0.9557$) for 95 and 120 °C, respectively.

„Mos teutonicus“

Rozvoj zejména po 2. křížové výpravě. R. 1300 pokus o její zákaz 1300 bulou papeže Bonifáce VIII.



Doklad „mos teutonicus“
(bazilika sv. Jiří, Pražský hrad)

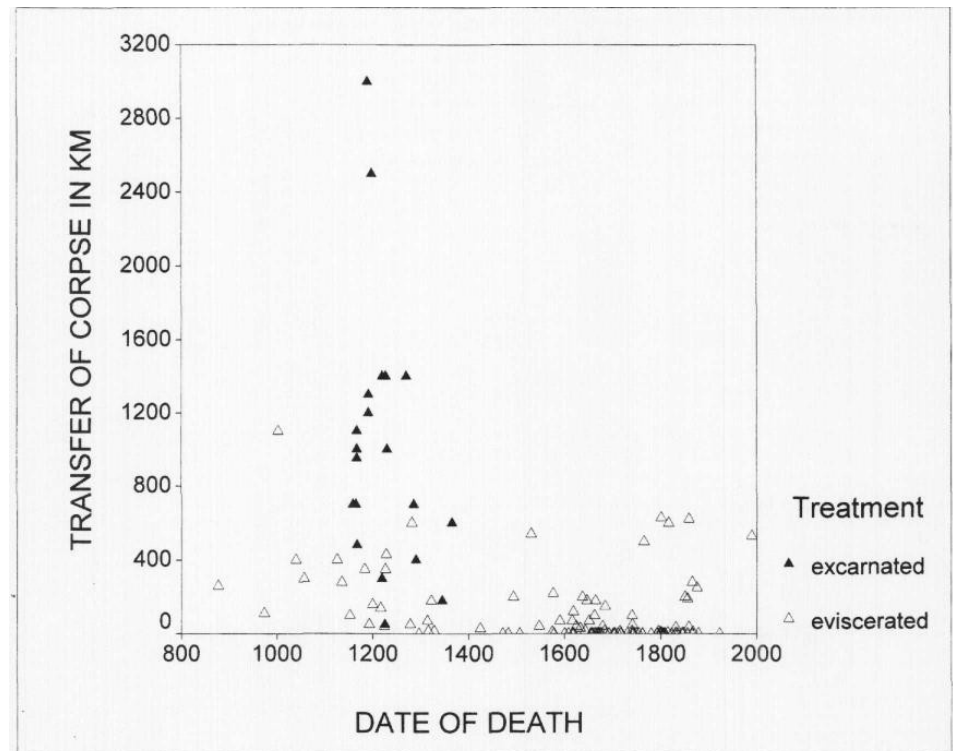


FIGURE 2. For a better demonstration of the relationship between corpse transport, evisceration and excarnation in the Middle Ages, in this graph data on 40 people were added to the sample, among them German, French and English kings and some nobles and bishops that all died between 877 and 1471. From the 17th century onwards, evisceration in the Habsburg dynasty was not related to body transport or an extended time interval between death and burial.

„Mos teutonicus“

Pozůstatky císaře Lothara I. († 1137) vykazovaly vyšší hodnotu poměru D/L forem kyseliny asparágové, než ve srovnávacích vzorcích (pozůstatky jeho ženy Reichenzy († 1141) a jeho zetě, vévody Jindřicha Lva († 1139), kteří zemřeli a byli pohřbeni přímo v Königslutteru). Z experimentální časové závislosti racemizace kyseliny asparágové v kosti ve vroucí vodě bylo možno odhadnout i dobu vaření císařova těla na cca 6 h 30 min



	Rok umrtí	D/L Asp	
		Postup A (4 h, 110 °C)	Postup B (4 h, 110 °C)
Reichenza	1141	0,059 ± 0,002	0,028 ± 0,004
Lothar I.	1137	0,090 ± 0,001	0,056 ± 0,001
Jindřich Lev	1139	0,059 ± 0,002	0,029 ± 0,004



Duke Heinrich
der Stolze
1139

Emperor
Lothar I
1137

Reichenza
(Lothar's wife)
1141

Fig. 1. Photograph of the three medieval (12th century) burials analysed in this study. The jumbled state of Lothar's skeleton in comparison to those of his two relatives is due to the opening of the sarcophagus in 1620. The year each individual died is given under their name.

Vliv degradace proteinu

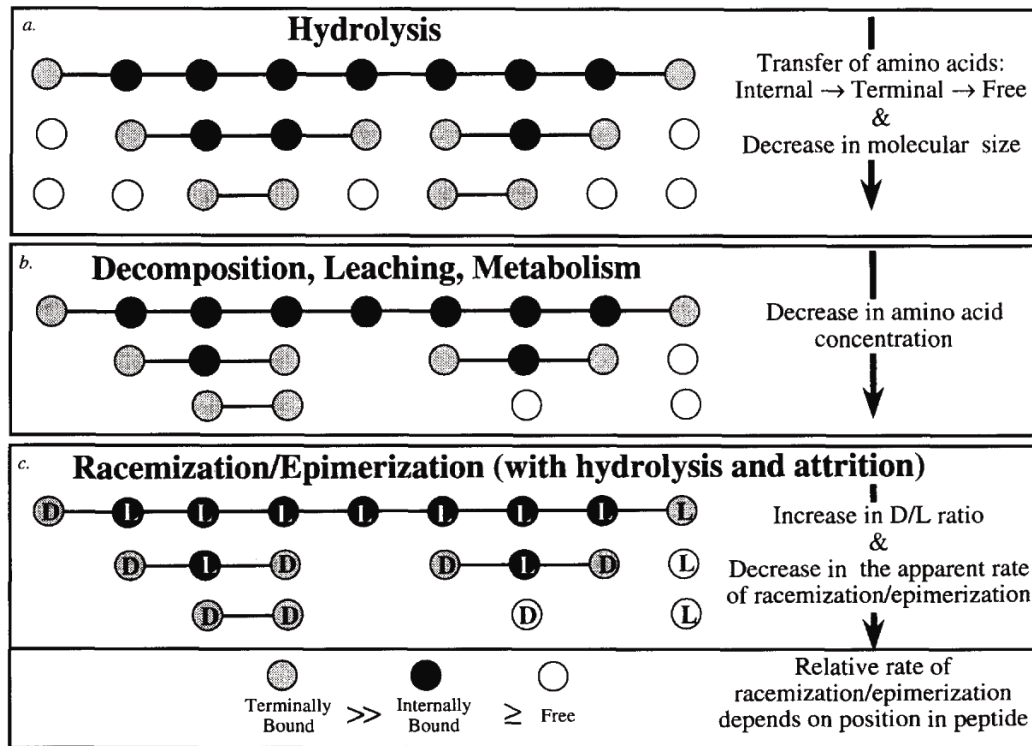


FIG. 1. Schematic presentation of protein diagenesis. (a) Proteins are hydrolyzed into smaller polypeptides, eventually forming free amino acids, resulting in an overall decrease in molecular size with an accompanying increase in terminally bound, then free amino acids. (b) Concurrent with hydrolysis, the concentration of amino acids may be reduced by attrition as amino acids are decomposed into non-amino molecules, leached from the mineral matrix, or possibly consumed by microbial activity. (c) Concurrent with protein hydrolysis and amino acid attrition, amino acids are racemized (or epimerized, in the case of the amino acid isoleucine). The ratio of D to L amino acids increases with time after death of an organism, but the apparent reaction rate, as measured in the total amino acid population, decreases as more amino acids are exposed to terminal positions, where they racemize most rapidly, and enter the free pool, where the rate decreases (cf. Krauskul and Mitterer, 1978).

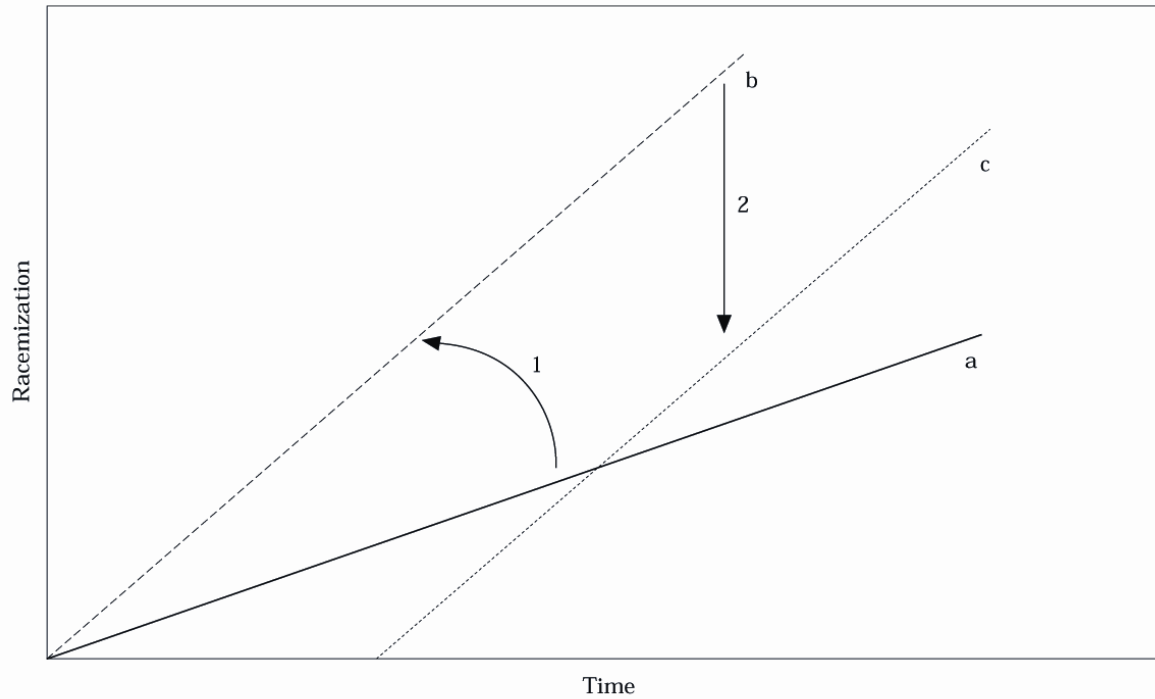


Figure 4. Hypothesis of an association of the racemization of an amino acid with the degradation of the protein. a: racemization of an amino acid inside a peptidic chain without surrounding influence nor hydrolysis; 1: physico-chemical influence which increase (or decrease) the racemization rate; b: racemization of a bound amino acid in a closed system; 2: opening of the system: input of L amino acid or output of D amino acid; c: racemization really observed (we suppose a flux of amino acid equal for all the bones).

D/L_{asp} variability in modern and fossil bone samples

	Modern		Fossil*	
	N(%)**	D/L _{asp} †	N(%)	D/L _{asp} †
Total	3.3	.07 ± .003 (5)	.007	.38 ± .009 (4)
Soluble	0.3	.08 ± .002 (5)	.003	.45 ± .012 (4)
Insoluble	2.5	.07 ± .003 (5)	.004	.12 ± .006 (4)

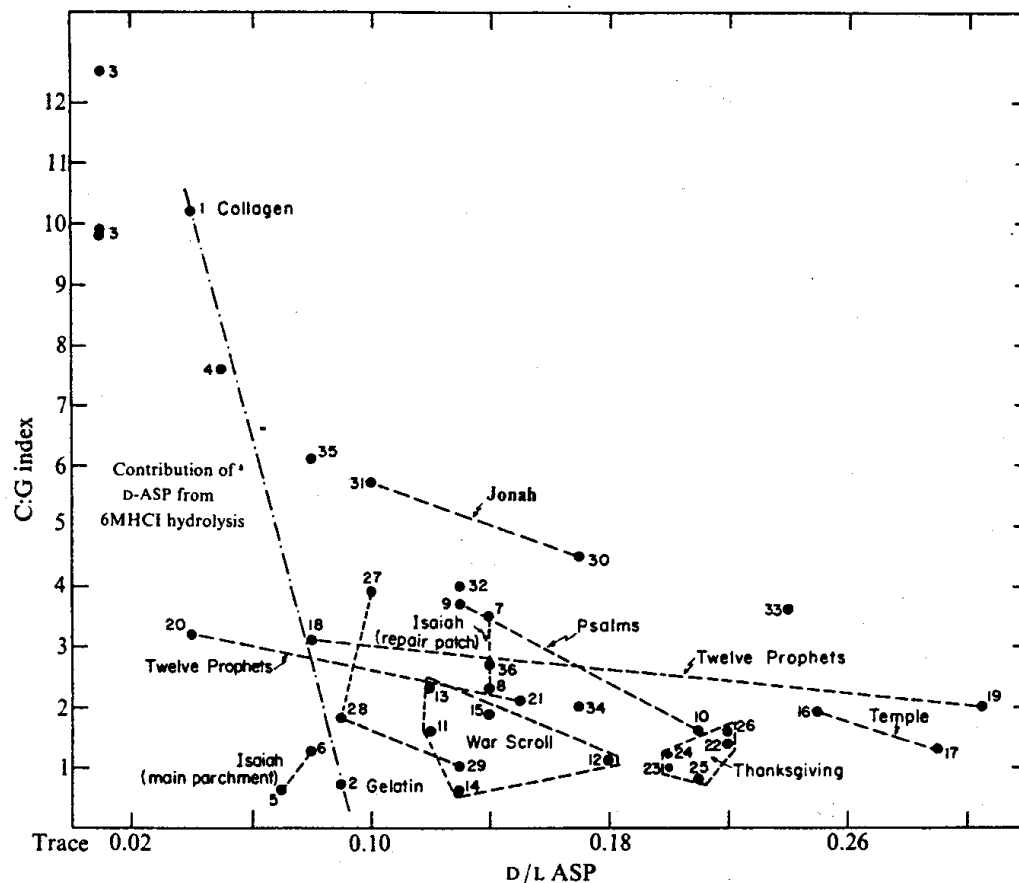
* *Bison occidentalis*, 12 Mile Creek, Kansas, 10,435 ± 260 ¹⁴C yr (GX-5812 A; apatite); 10,245 ± 335 ¹⁴C yr (GX-5812, gelatin). Ref: Rogers & Martin (1984)

** Nitrogen content determined from amino acid composition data

† Figures in parentheses indicate number of replicate analyses

Přeměna kolagenu na želatinu je klíčovým faktorem degradace pergamenu. Její vliv na racemizaci kyseliny asparágové (Asp) – srovnání s poměrem C:G získaný rtg. difrakcí.

Fig. 3 The index plotted against D/L Asp of the samples analysed. For racemization analyses, ~2–5 mg of parchment were used. The parchment surfaces were mechanically cleaned, soaked in double distilled water for 2–3 h at room temperature and then transferred to 0.5 M acetic acid for 4 h at room temperature to remove the more soluble contaminants. The samples were hydrolysed in redistilled 6M HCl *in vacuo* at 150 °C for 40 min. Amino acid compositions of the random fragments closely resemble the amino acid composition of collagen. After extensive drying, the hydrolysates were derivatized to *N*-trifluoroacetyl isopropyl ester as described previously¹⁵. The samples were dissolved in ether and passed through a silica column (Merck, 200 mesh) in a Pasteur pipette. The aspartic acid enantiomers were separated by gas-liquid chromatography using a stainless capillary column coated with *N*-lauroyl-L-valine *t*-butylamide¹⁶. To confirm the identity of the D-Asp peak some of the samples were also chromatographed on the corresponding D-valine phase, which showed the expected peak reversal. Where large amounts of D-Asp were found, trace amounts of D-alanine and occasionally D-leucine, were also observed. The relative proportions of D- and L-Asp were measured by peak height. The reproducibility of the analyses is 5–10%. However, a significant portion of this variability may be due to sample heterogeneity. The ratios have not been corrected for the amounts of D-Asp generated during hydrolysis.



Patologické změny

Poměr D a L formy kyseliny asparágové(Asp) může být ovlivněn přítomností patologických změn tkání.

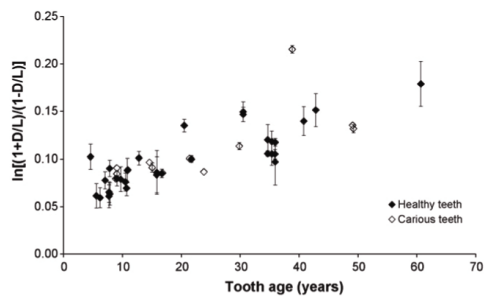


Fig. 4. $\ln \left(\frac{1 + \text{Ser } D/L}{1 - \text{Ser } D/L} \right)$ by age for caries-free enamel from carious teeth and healthy teeth. Error bars represent 1st standard deviation about the mean for multiple measurements from the same tooth.

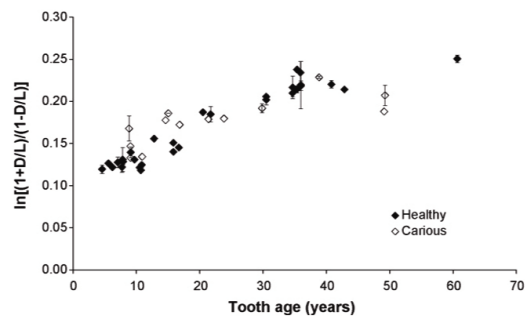


Fig. 3. $\ln \left(\frac{1 + \text{Asx } D/L}{1 - \text{Asx } D/L} \right)$ by age for caries-free enamel from carious teeth and healthy teeth. Error bars represent 1st standard deviation about the mean for multiple measurements from the same tooth.

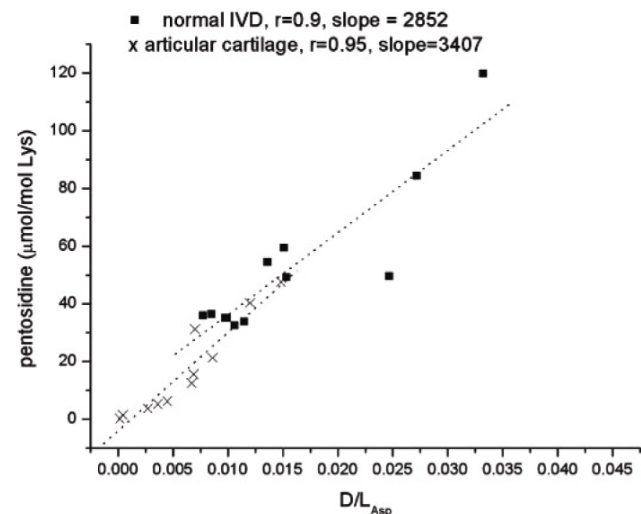


FIGURE 5. Pentosidine accumulation as a function of D/L-Asp for collagen from normal human IVD compared with normal articular cartilage

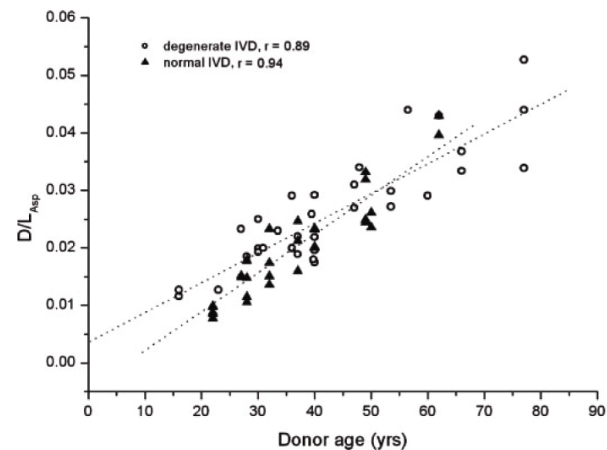


FIGURE 2. D/L-Asp in collagen obtained from normal (\blacktriangle) and degenerate (\circ) human IVD tissues as a function of donor age. Because of an insignificant difference ($p > 0.05$, t test) between NP and AF of the same tissue, the data were pooled. The similar r values for the two data sets suggest that there is no additional contribution to the scatter of the degenerate data points due to the pooling of tissues with different pathologies.

Druh tkáně

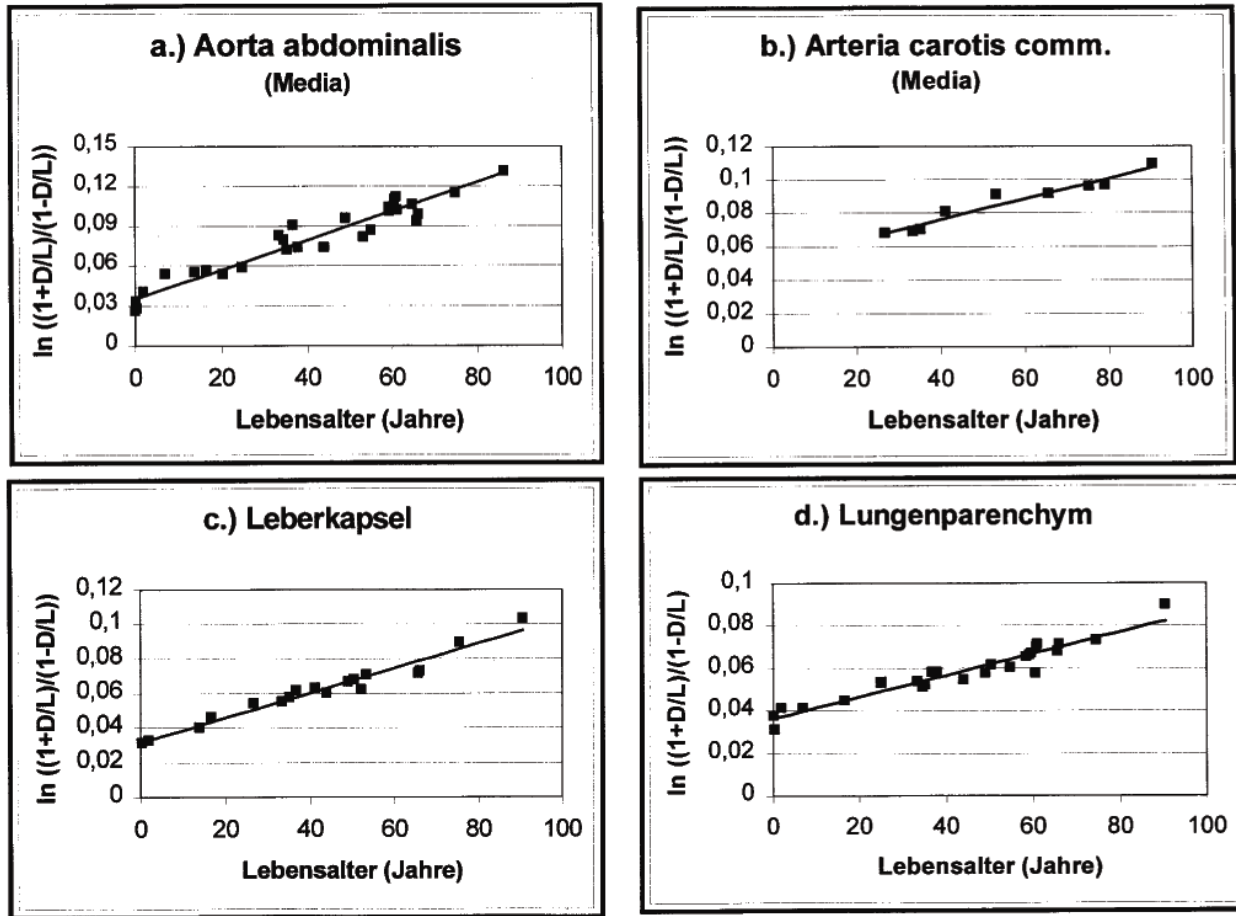


Abb. 2 a–d Enger Zusammenhang zwischen Alter und Razemisierungsgrad von Asparaginsäure ($\ln((1+D/L)/(1-D/L))$; $D/L = D/L$ -Asparaginsäure) als Beleg für die Existenz erheblicher Konzentrationen permanenter Proteine in der Media verschiedener Arterien (**2 a** und **2 b**), in der Leberkapsel (**2 c**) sowie in Lungen-

parenchym (**2 d**). Die Gesamtgewebeproben wurden in feine Stücke zerkleinert, in einer 15% NaCl-Lösung und einem Äthanol/Äther-Gemisch (3:1) gewaschen und getrocknet. Zur Bestimmung des Razemisierungsgrades von Asparaginsäure wurde die an anderer Stelle beschriebene Methodik eingesetzt (21, 24)

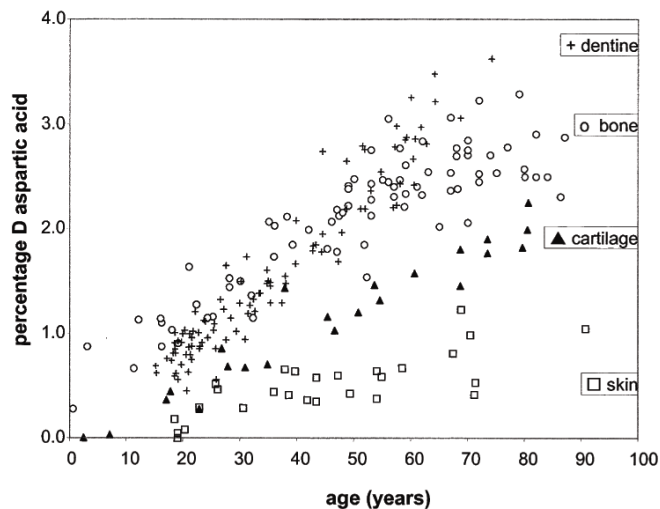


Fig. 2. Comparison between the increase in D-Asx in four collagen rich tissues, acid insoluble fraction of dentine (Ritz et al., 1993), acid insoluble fraction of bone (Ritz et al., 1994; Ohtani et al., 1998b), collagen preparations from cartilage (Verzijl et al., 2000) and skin (Verzijl et al., 2000). Data have been corrected for induced racemization.

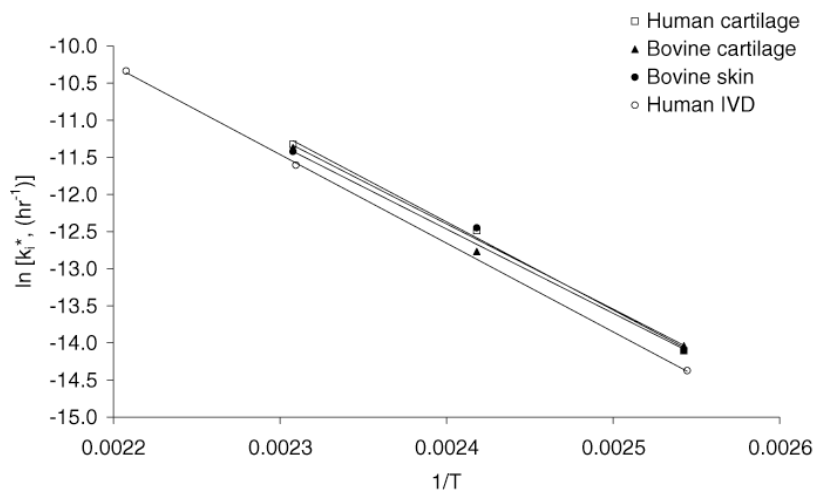


FIGURE 1. *In vitro* rate constants for racemization of aspartic acid in collagen molecules as obtained from different tissues. The Arrhenius plot shows the relation between the *in vitro* rate constant for racemization of aspartic acid (k_i^*) and the reciprocal of the absolute temperature as measured for human (□) and bovine (▲) cartilage, bovine skin (●) (16), and human IVD (○) (this work). Data were obtained using heating experiments as described under "Experimental Procedures."

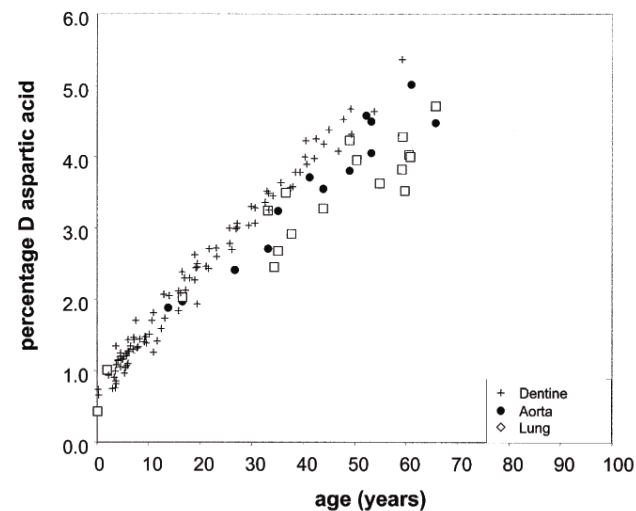


Fig. 1. Close relationship between age and the increase in D-Asx in dentine, in lung parenchyma, and in the media of the thoracic aorta. The dentine (3rd molar root) samples were treated as described before (Ritz et al., 1993), the other total tissue samples were minced in fine pieces, washed in a 15% NaCl solution and in ethanol/ether (3:1), and dried. The extent of aspartic acid racemization was determined as described elsewhere (Ritz et al., 1993; Ritz-Timme, 2000) and have here been corrected for the racemization (0.084%) induced during hydrolysis (6 h at 100 °C), to illustrate the initially rapid increase in D-Asx following synthesis. The data for 3rd molar root dentine is plotted relative to age of synthesis not absolute age.

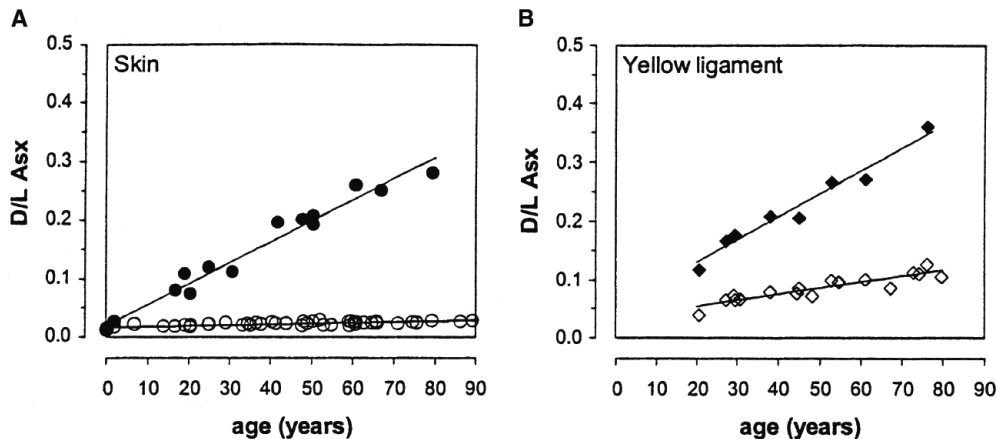


Figure 2. Aspartic acid racemization (as $D/L = D$ -aspartic acid/ L -aspartic acid) in total tissue samples (open symbols) and in elastin preparations (solid symbols) from (A) skin and (B) yellow ligaments (control experiment) related to age. The similarity of the data sets for the elastin preparations from skin and the yellow ligaments indicates an acceptable purity of the elastin preparations. The age-dependent accumulation of D -aspartic acid in the elastin preparations proves the longevity of elastin.

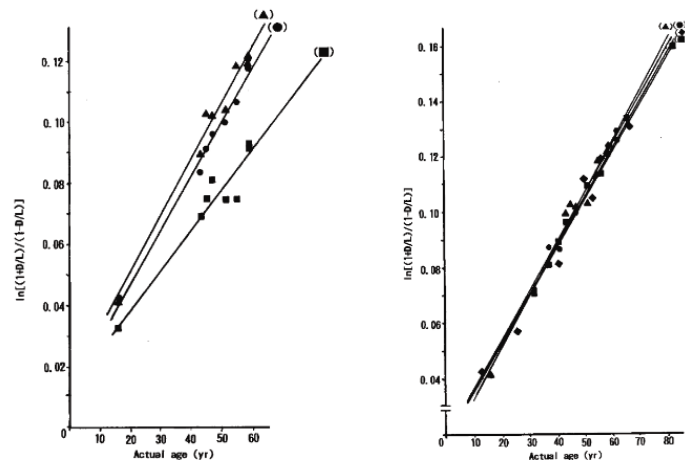


Fig. 3. Comparison of D/L ratio for samples of cementum, enamel, and dentine of the first premolar of the same individual. \blacktriangle , cementum, $\ln[(1 + D/L)/(1 - D/L)] = 0.001836t + 0.0147$; \blacksquare , enamel, $\ln[(1 + D/L)/(1 - D/L)] = 0.001299t + 0.0128$; \bullet , dentine, $\ln[(1 + D/L)/(1 - D/L)] = 0.001750t + 0.0122$.

Fig. 2. Relation between age and D/L ratio for samples of whole cementum. \bullet , central incisor, $\ln[(1 + D/L)/(1 - D/L)] = 0.001765t + 0.0172$; \blacksquare , lateral incisor, $\ln[(1 + D/L)/(1 - D/L)] = 0.001712t + 0.0193$; \blacktriangle , first premolar, $\ln[(1 + D/L)/(1 - D/L)] = 0.001836t + 0.0147$; \bullet , second premolar, $\ln[(1 + D/L)/(1 - D/L)] = 0.001770t + 0.0159$.

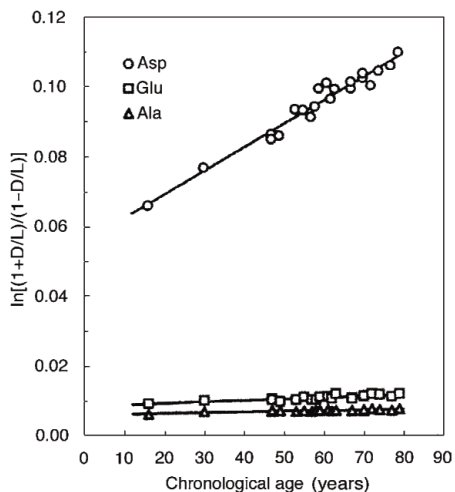


FIG. 2—Correlation between the degree of racemization of total amino acids obtained from the femur and chronological age.

$$\begin{aligned} \text{Asp, } \ln[(1 + D/L)/(1 - D/L)] &= 0.000674t + 0.0556; k = 3.3571 \times 10^{-4} \\ \text{Glu, } \ln[(1 + D/L)/(1 - D/L)] &= 0.000042t + 0.0084; k = 2.0425 \times 10^{-5} \\ \text{Ala, } \ln[(1 + D/L)/(1 - D/L)] &= 0.000019t + 0.0060; k = 9.4875 \times 10^{-6} \end{aligned}$$

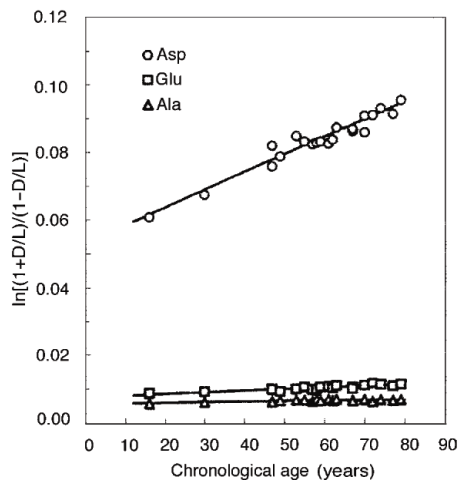


FIG. 3—Correlation between the degree of racemization of amino acids in the acid-insoluble collagen-rich fraction (IC) obtained from the femur and chronological age.

$$\begin{aligned} \text{Asp, } \ln[(1 + D/L)/(1 - D/L)] &= 0.000518t + 0.0533; k = 2.5880 \times 10^{-4} \\ \text{Glu, } \ln[(1 + D/L)/(1 - D/L)] &= 0.000047t + 0.0077; k = 2.3651 \times 10^{-5} \\ \text{Ala, } \ln[(1 + D/L)/(1 - D/L)] &= 0.000017t + 0.0057; k = 8.5370 \times 10^{-6} \end{aligned}$$

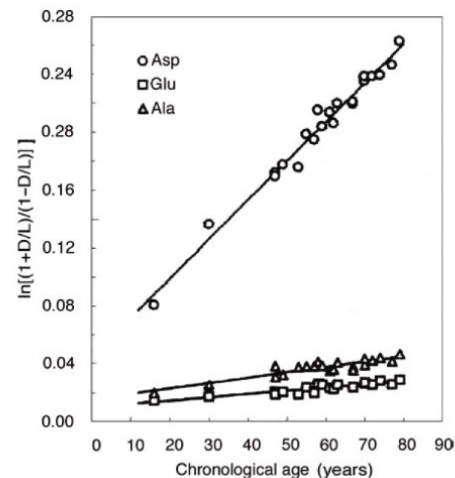


FIG. 4—Correlation between the degree of racemization of amino acids in the acid-soluble peptide fraction (SP) obtained from the femur and chronological age.

$$\begin{aligned} \text{Asp, } \ln[(1 + D/L)/(1 - D/L)] &= 0.002712t + 0.0446; k = 1.3558 \times 10^{-3} \\ \text{Glu, } \ln[(1 + D/L)/(1 - D/L)] &= 0.000228t + 0.0097; k = 1.1398 \times 10^{-4} \\ \text{Ala, } \ln[(1 + D/L)/(1 - D/L)] &= 0.000375t + 0.0153; k = 1.8762 \times 10^{-4} \end{aligned}$$

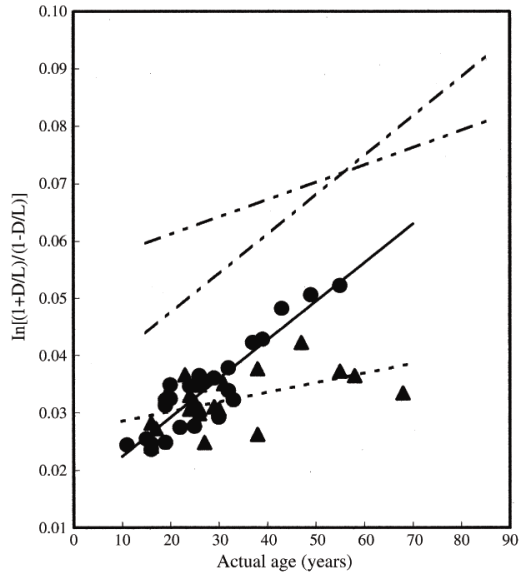


Fig. 2 – Comparison of rate equations between alveolar bone and femur.^{8,9} Male alveolar bone ● (—), $\ln[(1 + D/L)/(1 - D/L)] = 0.000677t + 0.0156$, $r = 0.912$, $n = 26$, $k(y) = 3.3839 \times 10^{-4}$; female alveolar bone ▲ (- - -), $\ln[(1 + D/L)/(1 - D/L)] = 0.000168t + 0.0268$, $r = 0.527$, $n = 21$, $k(y) = 8.4170 \times 10^{-5}$; male femur (- · - · -), $\ln[(1 + D/L)/(1 - D/L)] = 0.000689t + 0.0336$; female femur, (· · · · ·), $\ln[(1 + D/L)/(1 - D/L)] = 0.000304t + 0.0550$. The r is correlation coefficient and $k(y)$ is rate constant.

Skull,	$\ln[(1 + D/L)/(1 - D/L)] = 0.000623t + 0.0363$;
Sternum,	$\ln[(1 + D/L)/(1 - D/L)] = 0.000820t - 0.0017$;
Rib cartilage	$\ln[(1 + D/L)/(1 - D/L)] = 0.000260t + 0.0380$;
Lumbar spine,	$\ln[(1 + D/L)/(1 - D/L)] = 0.000743t + 0.0035$;
Coxal bone,	$\ln[(1 + D/L)/(1 - D/L)] = 0.000534t + 0.0150$;
Sacral spine,	$\ln[(1 + D/L)/(1 - D/L)] = 0.000150t + 0.0388$;
Femur,	$\ln[(1 + D/L)/(1 - D/L)] = 0.000558t + 0.0361$;

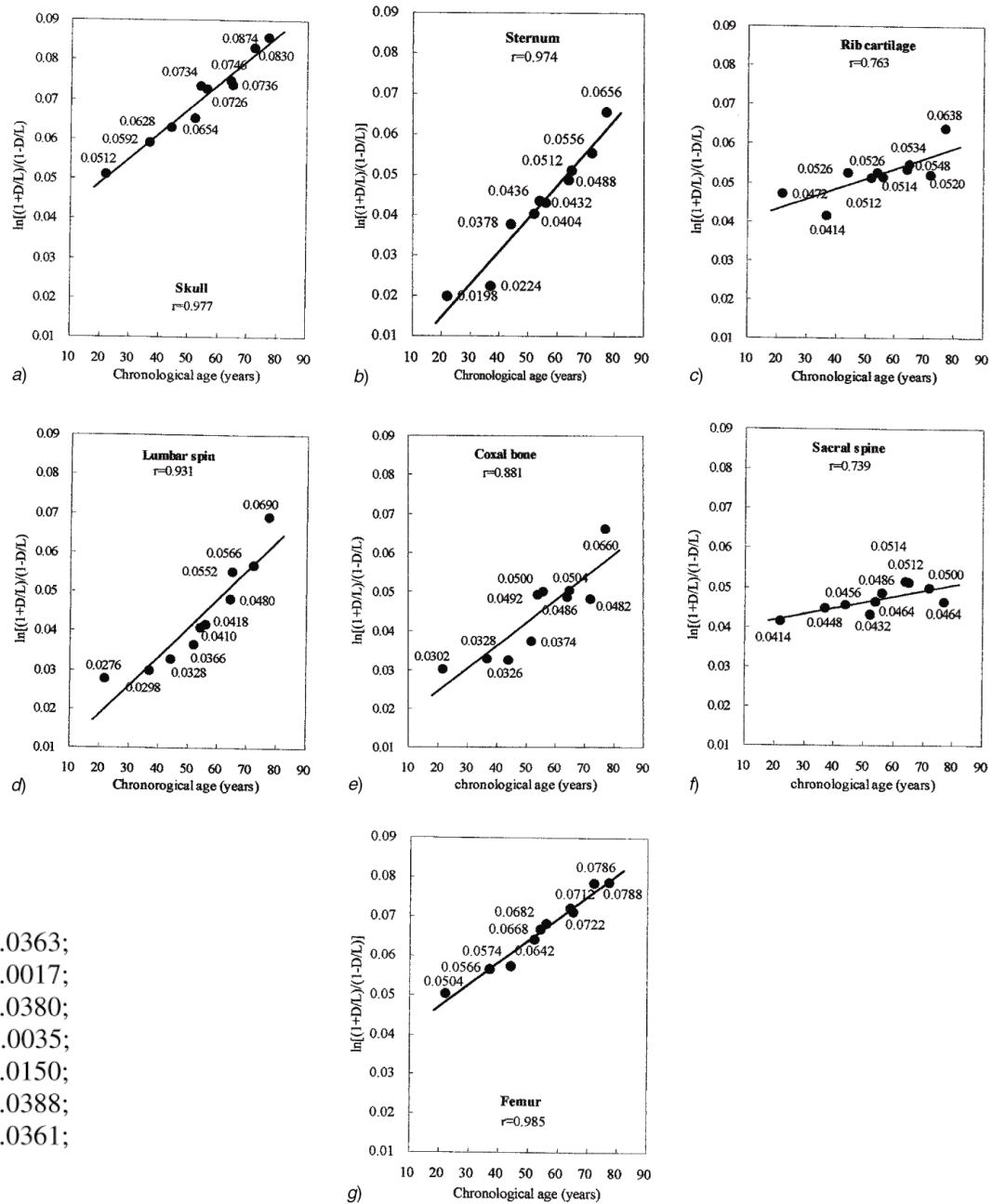
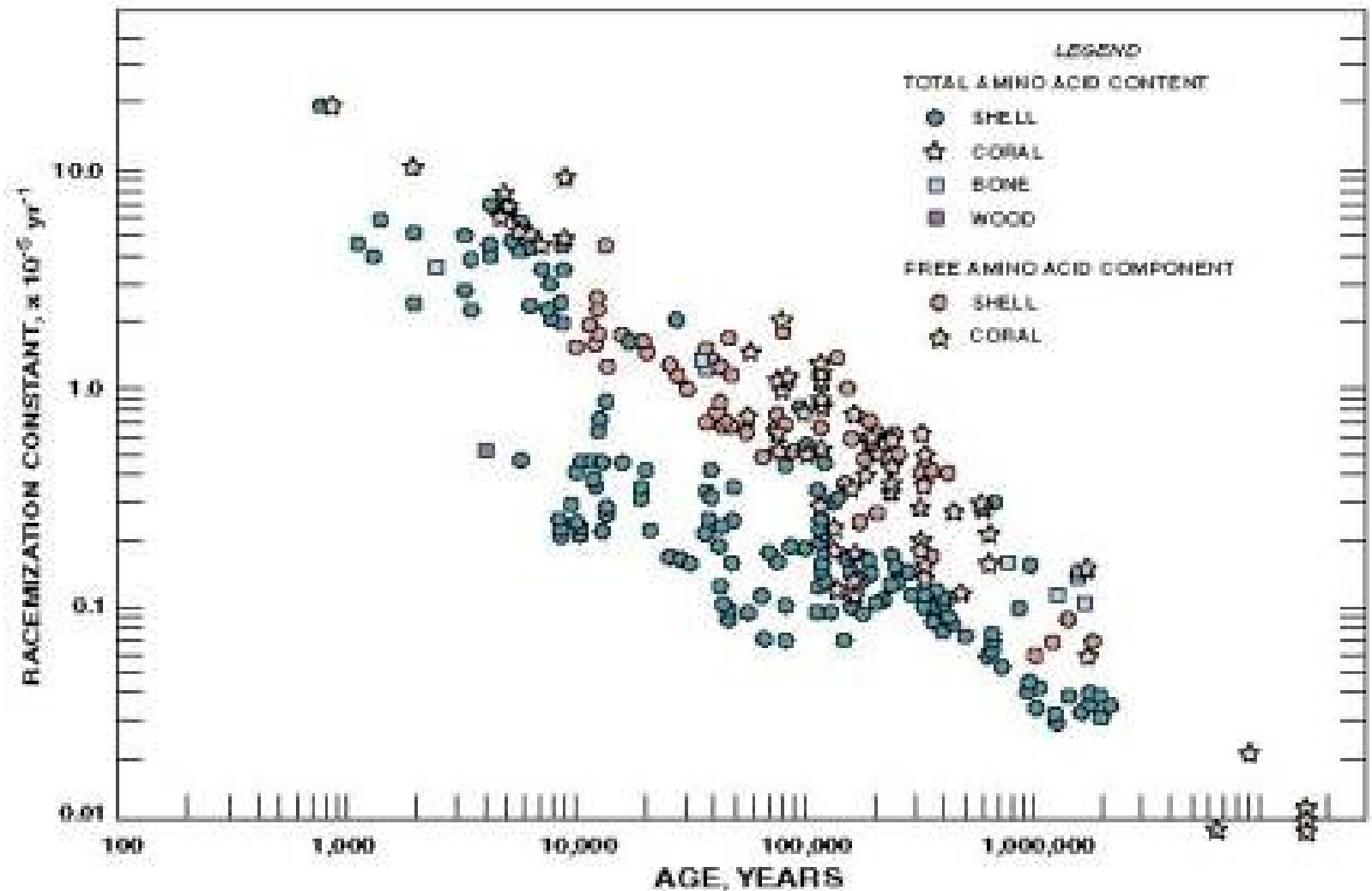


FIG. 2—G Correlation between the D/L ratio of aspartic acid in each specimen and chronological age. a) skull; $r = 0.977$; $\theta_{(y)} = 13.08$; $P < 0.001$. b) sternum; $r = 0.974$; $\theta_{(y)} = 12.16$; $P < 0.001$. c) rib cartilage; $r = 0.763$; $\theta_{(y)} = 3.34$; $P: 0.02 - 0.01$. d) lumbar spine; $r = 0.931$; $\theta_{(y)} = 7.21$; $P < 0.001$. e) coxal bone; $r = 0.881$; $\theta_{(y)} = 5.27$; $P < 0.001$. f) sacral spine; $r = 0.739$; $\theta_{(y)} = 3.10$; $P: 0.02 - 0.01$. g) femur; $r = 0.985$; $\theta_{(y)} = 16.15$; $P < 0.001$. The r is the coefficient of correlation.



Isoleucine Racemization Rate Constant versus Associated Fossil Age. Data from Bada 1981, Bada and Protsch 1973, Bada and Schroeder 1972, Bada et al. 1973, Bischoff and Childers 1979, Blake 1980, Hare and Mitterer 1966, King and Neville 1977, Kvenvolden 1980, Kvenvolden et al. 1973, Lee et al. 1976, Masters and Bada 1977, Miller and Hare 1980, Mitterer 1975, Stafford et al. 1984, Szabo et al. 1981, Wehmiller 1977, Wehmiller and Hare 1971, Wehmiller et al. 1976. [R. H. Brown, Amino Acid Dating, Origins 12(1):8-25 (1985)]

Určení věku

- u historického materiálu se uplatňuje i vliv postmortální racemizace

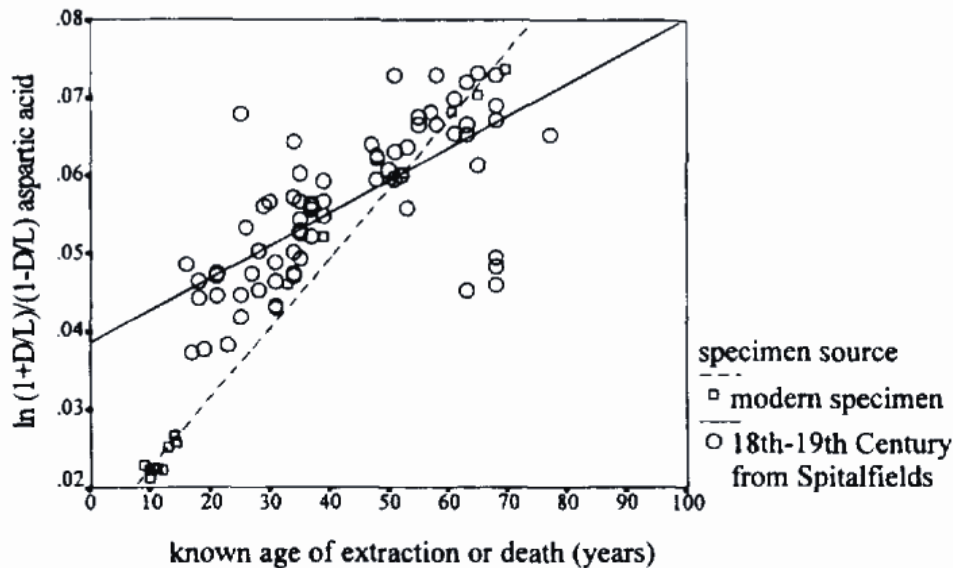


FIG. 5—Plot of $\ln\{(1 + (D/L))/(1 - (D/L))\}$ aspartic acid with regression lines depicted for 18th C. specimens (Spitalfields) and modern specimens.

L-methionin nepodléhá racemizaci in vivo, lze ho použít jako vnitřní standard: poměr D-Asp/D-Met eliminuje efekt racemizace během přípravy vzorku.

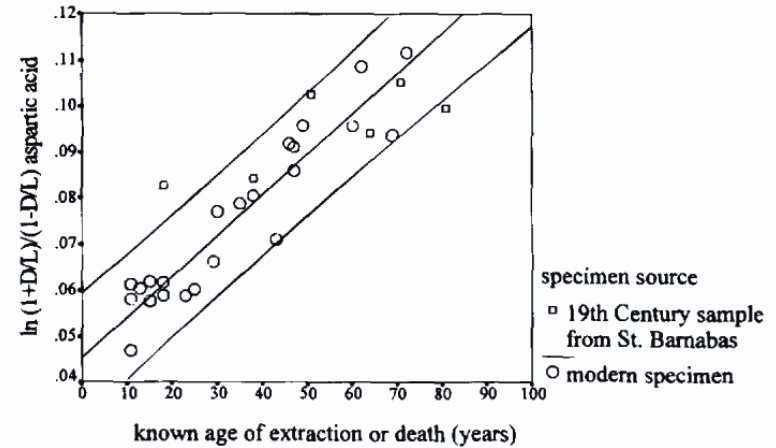


FIG. 1—Plot of $\ln\{(1 + (D/L))/(1 - (D/L))\}$ aspartic acid against age with 95% confidence bands for St. Barnabas (19th C.) and modern dental samples.

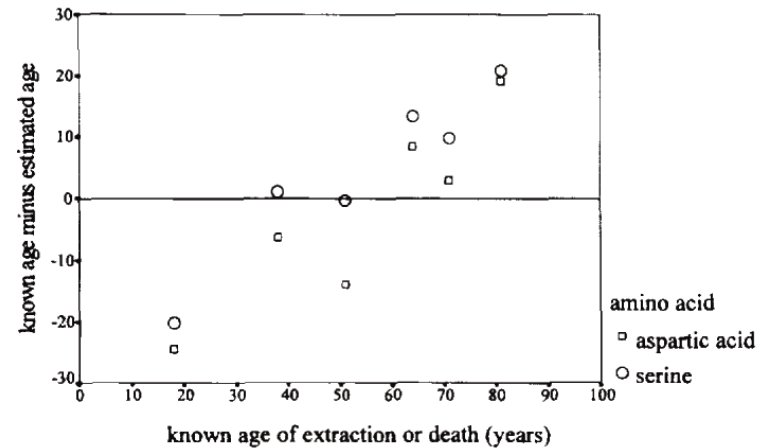


FIG. 4—Plot of known age against true error in estimated age for aspartic acid and serine for six 19th Century specimens. (Estimated age obtained by using the modern data as a calibration curve for the 19th C. samples. True error is difference between estimated age and known age).

St. Lawrence Island (Aljaška)

Cca 1600 let stará (^{14}C 370-390 ± 90 let) zmrzlá „mumie“ eskymácké ženy, nalezená 1972 na St. Lawrence Island (Aljaška). Morfologicky (atrofie prsou a vaječníků, otřetí zubů, choroba koronárních cév) byl věk odhadnut na 50-60 let. Analýza racemizace Asp v dentinu indikovala věk 53 ± 5 let. Mrtvola ležela ve věčně zmrzlé půdě, vliv postmortálních změn na racemizaci je tak minimální.



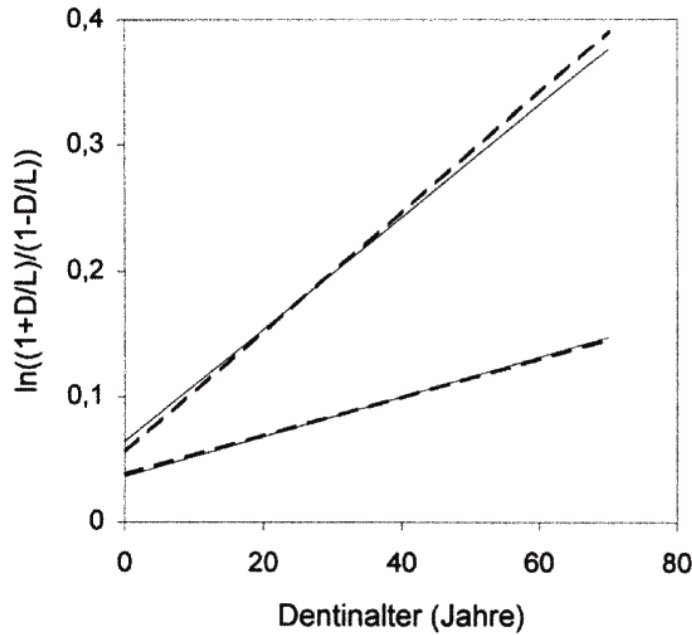
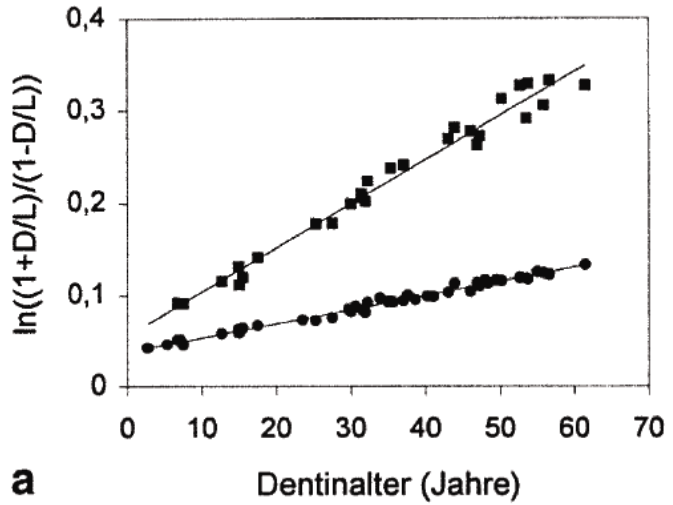
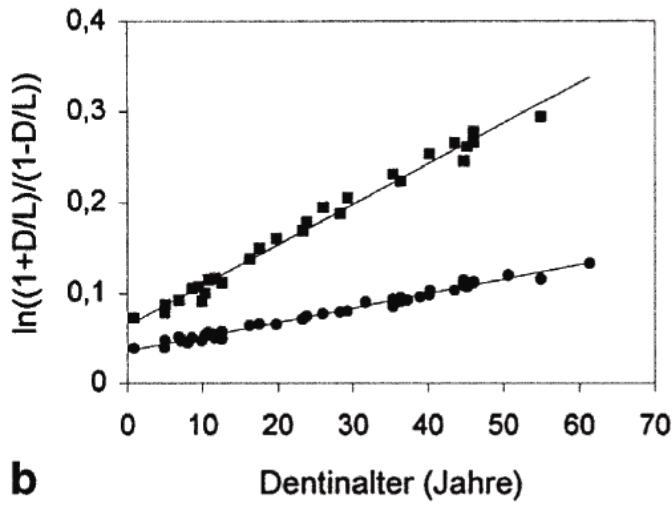


Abb. 2 ◀ **Optischer Eindruck der Gleichheit des Verlauf der Regressionsgeraden für das deutsche (gestrichelte Geraden) und das türkische Kollektiv (durchgezogene Geraden): Die beiden flacher verlaufenden Geraden sind die Regressionsgeraden für Gesamtdentin, sie liegen nahezu übereinander (y-Achse: Razemisierungsgrad von Asparaginsäure als $\ln[(1+D/L)/(1-D/L)]$, $D/L=D$ -Asparaginsäure/ L -Asparaginsäure)**



a



b

Abb. 1a,b ◀ **Razemisierungsgrad von Asparaginsäure (als $\ln[(1+D/L)/(1-D/L)]$; $D/L=D$ - L -Asparaginsäure) in Gesamtdentin (Kreise) und der säurelöslichen Dentinproteinfraktion (Quadrate) in Abhängigkeit vom Dentalter: a im deutschen Kollektiv, b im türkischen Kollektiv**

Datování

Pokud je racemizace in vivo zanedbatelná oproti racemizaci postmortální.

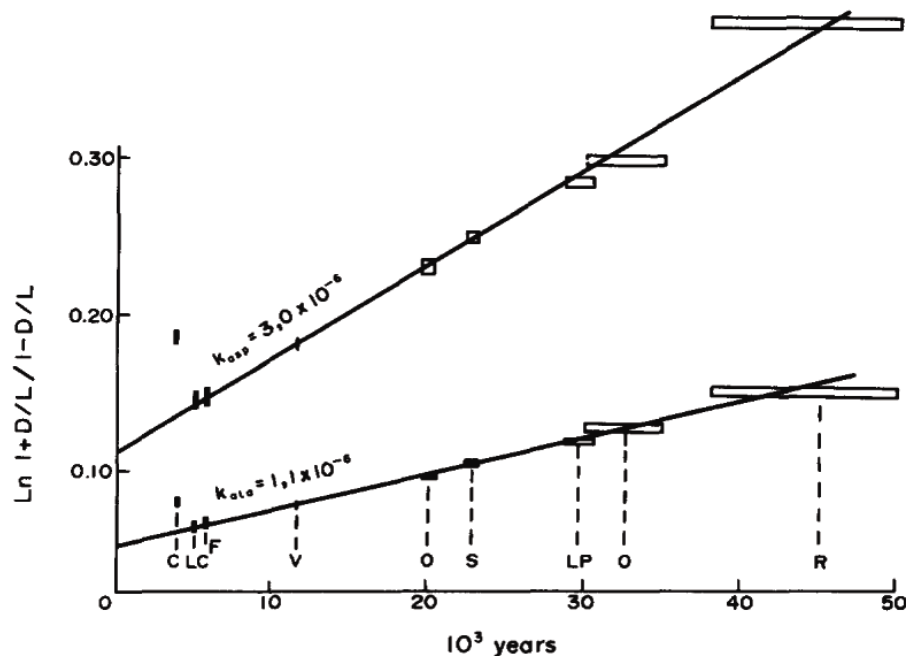


FIG. 2. Rate of racemization of Asp and Ala versus fossil bone age.

Legend: C = La Couronne O = Oullins
 LC = Les Cohons S = Salpêtrière
 F = Fontbrégoua LP = Abri des Pêcheurs
 V = Valorgues R = Rigabe.

D/L ratios of amino acids from bone samples of the Yuha skeleton

Bone type	Valine	Alanine	Leucine	Proline	Aspartic acid	Phenylalanine	Glutamic acid	<i>D</i> -alloisoleucine	
								<i>L</i> isoleucine	
Clavicle (spongeosa) *	0.12	0.26	0.13	0.13	0.44	0.19	0.31	0.10	
Metatarsal (spongeosa) *	0.08	0.26	0.09	0.14	0.41	0.12	0.32	0.07	
Femur (compacta) *	0.12	0.28	0.16	0.12	0.52	0.17	0.34	n a	
Femur (compacta) **	0.083	0.47	n a	0.076	0.56	n a	0.33	n a	
Unclassified fragment (compacta) ***	0.09	0.35	0.15	0.21	0.54	0.20	0.35	—	

* Analyzed by K. Kvenvolden and D. Blunt, U.S. Geological Survey, Menlo Park, Ca

** Analyzed by J. Bada and E. Hoopes, University of California, San Diego, Ca

*** Analyzed by E. Peterson, Ames Research Center, Sunnyvale, Ca

Ketef Hinnom

(Jeruzalém)

- reutilizace pohřební jeskyně v době římské.

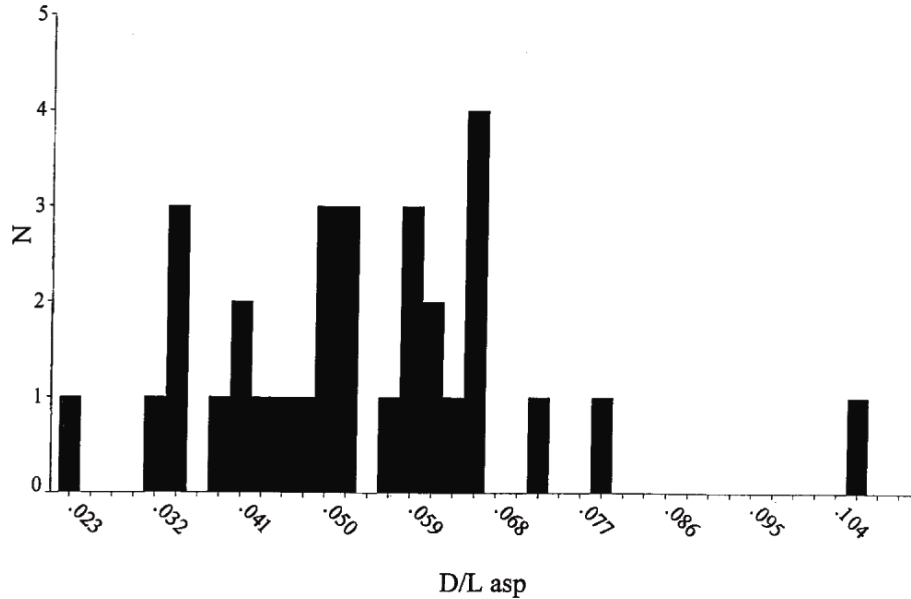


Figure 3. Distribution of D/L aspartic acid values for 31 tooth samples from the Ketef Hinnom tombs.

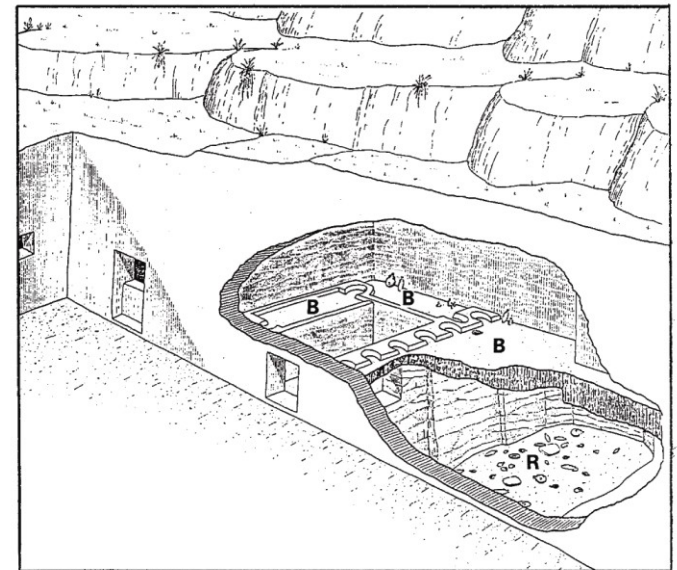
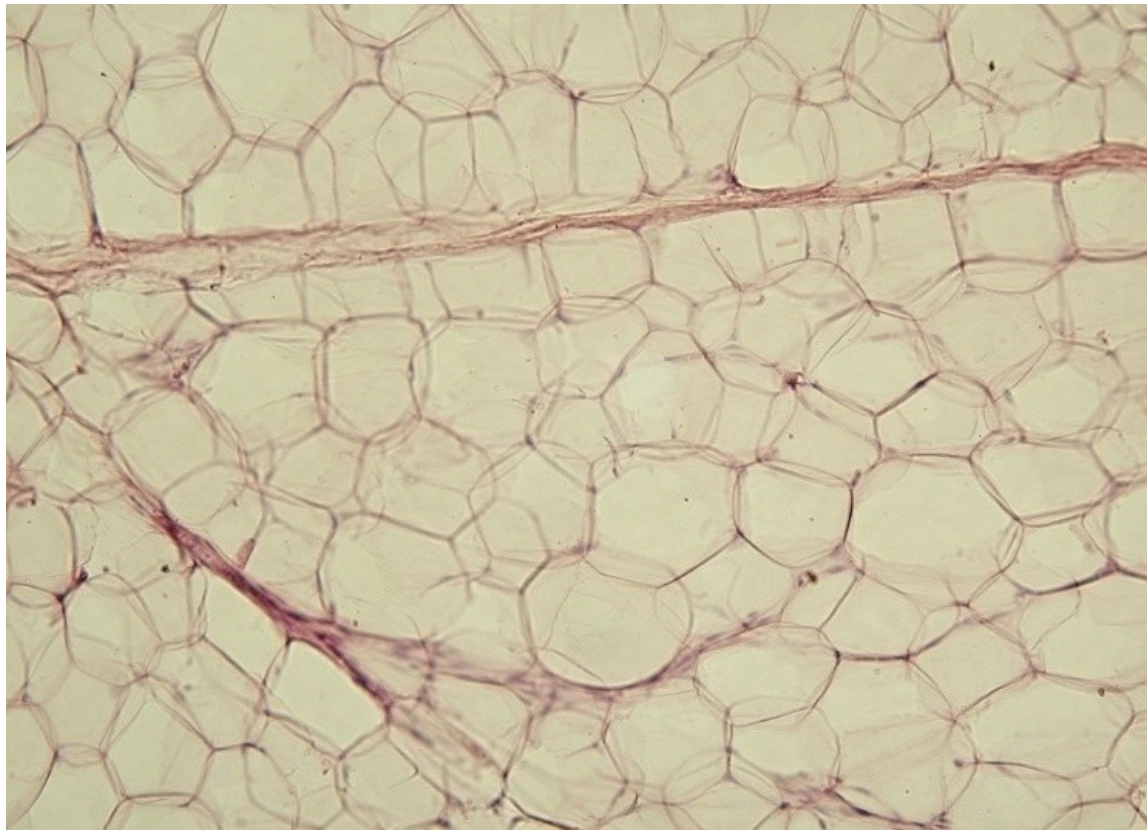


Figure 1. Tomb 25 at Ketef Hinnom, showing burial benches (B) and repository (R). The top portions of the tomb were apparently removed during construction of a Byzantine church. (from Barkay, 1986).

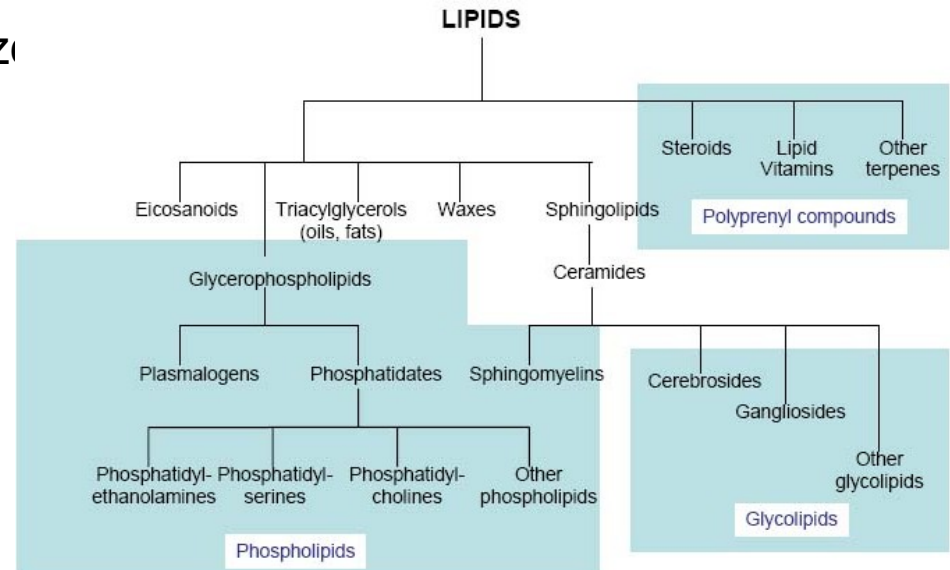
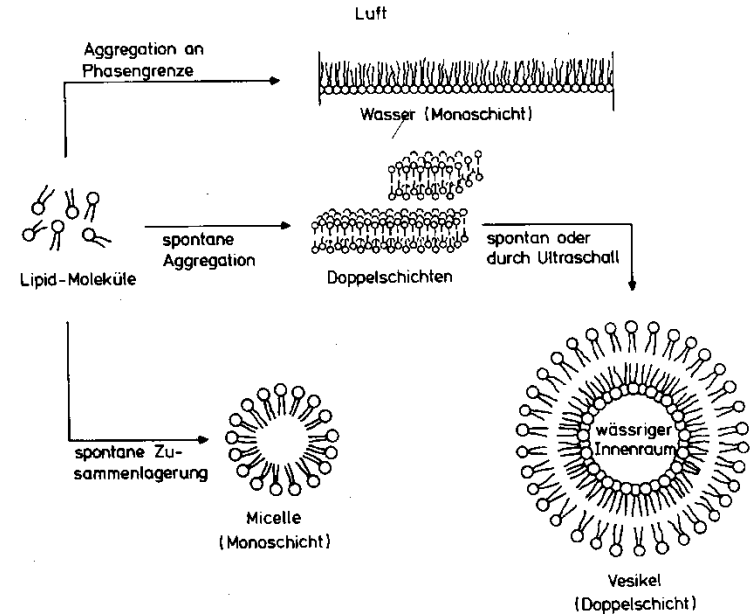
Tuky a oleje



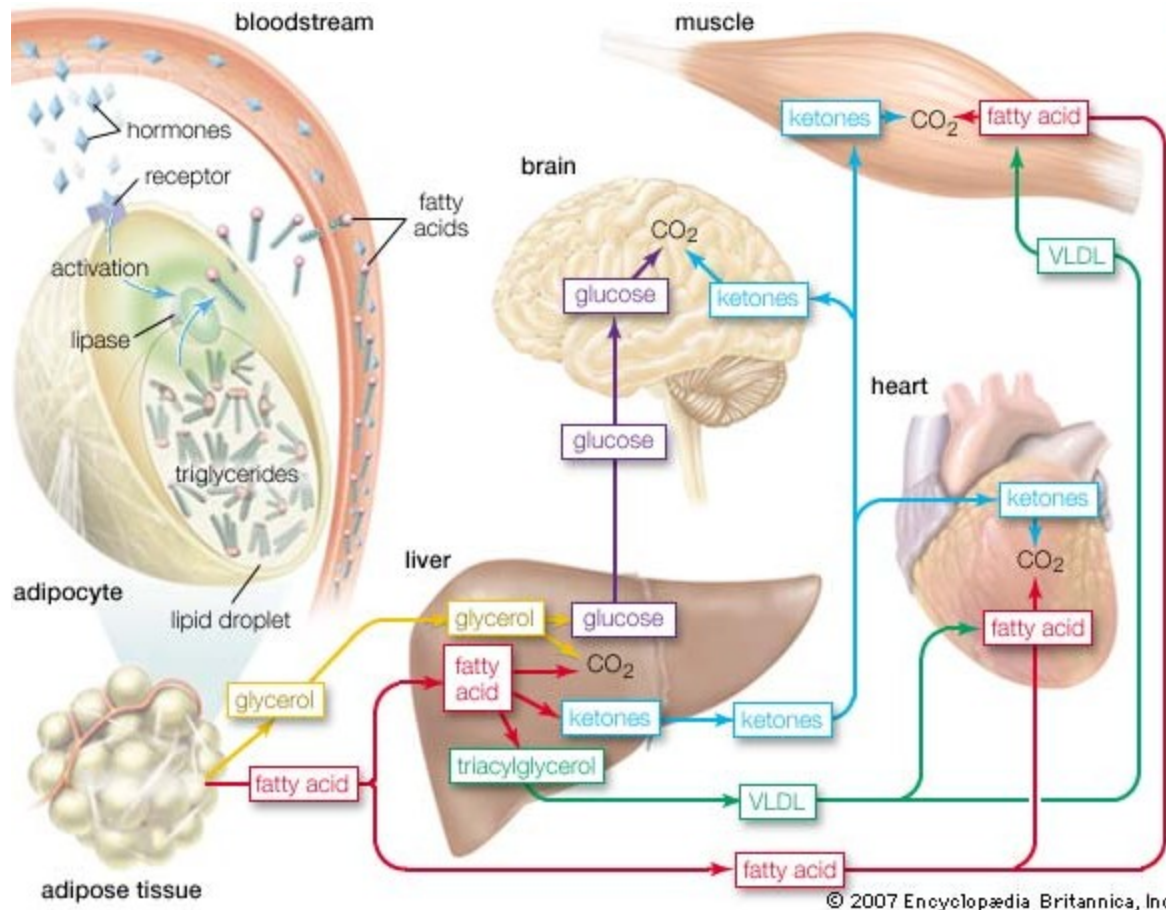
Lipidy

= estery vyšších mastných kyselin

- Glyceridy (glycerol)
 - Tuky
 - Oleje
- Vosky (alkoholy s dlouhým řetězi)
- Ostatní (cholesterol, aj.)



Mastné kyseliny



Nasyčené mastné kyseliny

Tabulka 7

Nasyčené mastné kyseliny jedlých tuků

Mastná kyselina	Systematický název	Počet atomů uhlíku	Molekulová hmotnost	Číslo kyselosti ⁺⁺)	Bod tání (°C)
Máselná	butanová	4	88,10	636,8	-4,6
Kapronová ⁺)	hexanová	6	116,16	483,0	-1,5
Kaprylová ⁺)	oktanová	8	144,21	389,1	16,3
Kaprinová ⁺)	dekanová	10	172,26	325,7	31,6
Laurová	dodekanová	12	200,31	280,1	43,6
Myristová	tetradekanová	14	228,36	245,6	56,8
Palmitová	hexadekanová	16	256,42	218,8	62,8
Stearová	oktadekanová	18	284,47	197,2	70,6
Arachová	ikosanová	20	312,52	179,5	76,3
Behenová	dokosanová	22	340,57	164,7	82,6
Lignocerová	tetrakosanová	24	368,62	152,2	84,8
Cerotová	hexakosanová	26	396,68	141,4	87,7

⁺) doporučuje se používat systematický název, aby nedošlo k záměně

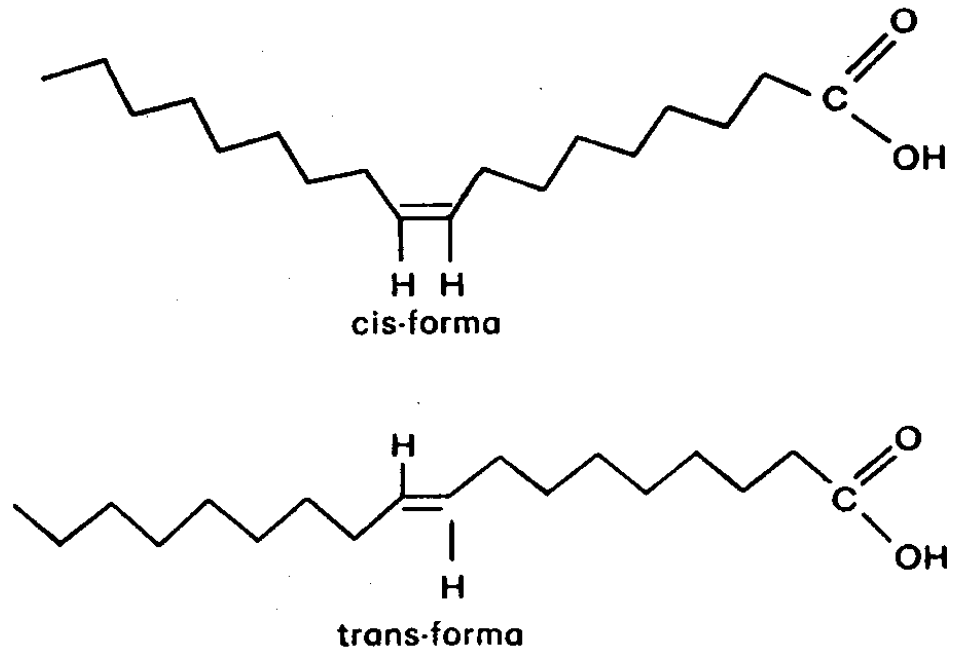
⁺⁺) mg KOH na 1 g vzorku

Nenasycené mastné kyseliny

Izomerie dvojné vazby v MK

Polohová

Geometrická: cis a trans



Nenasycené mastné kyseliny

Tabulka 8
Nenasycené mastné kyseliny jedlých tuků

Mastná kyselina	Počet atomů uhlíku	Poloha dvojných vazeb	Molekulová hmotnost	Číslo kyselosti ⁺)	Jodové číslo ⁺⁺)
Myristolejová	14	9	226,35	247,9	112,1
Palmitolejová	16	9	254,40	220,5	99,8
Olejová	18	9	282,45	198,6	89,9
Elaidová	18	9- <i>trans</i>	282,45	198,6	89,9
Vakcenová	18	11- <i>trans</i>	282,45	198,6	89,9
Petroselová	18	6	282,45	198,6	89,9
Gadolejová	20	9	310,50	180,7	81,8
Eruková	22	13	338,56	165,7	75,0
Brassidová	22	13- <i>trans</i>	338,56	165,7	75,0
Linolová	18	9, 12	280,44	200,1	181,0
Linolenová	18	9, 12, 15	278,42	201,5	273,5
γ-Linolenová	18	6, 9, 12	278,42	201,5	273,5
Arachidonová	20	5, 8, 11, 14	304,46	184,2	333,5
Klupanodonová	22	4, 8, 11, 14, 17	330,49	169,8	384,0
Dokosahexaenová	22	4, 7, 10, 13, 16, 19	328,35	171,2	465,2

⁺) mg KOH na 1 g vzorku

⁺⁺) % adovaného jodu

Nenasycené mastné kyseliny

Oleje nevysychavé - vysoký obsah nasycených MK: olivový, ricinový

Oleje pomalu vysychavé - značný obsah kyseliny linolové: makový, ořechový

Oleje rychle vysychavé - vysoký obsah kyseliny linolenové: lněný, čínský dřevný (tungový)

Hranice mezi skupinami jsou nezřetelné.

Tabulka 7 Složení mastných kyselin typických druhů rostlinných olejů

Kyselina	Lněný olej (hm. %)	Makový olej (hm. %)	Ořechový olej (hm. %)
palmitová	6	10	8
stearová	4	2	3
olejová	22	11	15
linolová	15	76	61
linolenová	52	-	12
ostatní	1	1	1
Poměr palmitové kys. ku stearové kyselině	1,5	5,0	2,6

Živočišné tuky

Tabulka 13

Složení mastných kyselin některých důležitých tuhých tuků

Mastná kyselina	Obsah (% veškerých mastných kyselin)							
	kokosový tuk	vepřové sádlo	hovězí lůj	mléčný tuk kravský	margarin ⁺)	pokrmový ⁺) tuk 100%ní	lidský tuk podkožní	tuk mateřského mléka
Máselná	0	0	0	2-4	0,1	0	0	0
Kapronová ^{*)}	0-0,8	0	0	1,4-2	0,1	0	0	0-0,1
Kaprylová ^{**)}	5,5-9,5	0-0,2	0	0,5-1,5	0-0,1	0	0	0-0,1
Kaprinová ^{***)}	4,5-9,5	0-0,2	0	1,6-2,7	0-0,1	0	0	0,5-1
Laurová	44-52	0,1-0,6	0,1-0,4	1,7-3,7	1-10	0-1	0,3-0,7	3-4
Myristová	13-19	1,4-2,4	2-3	7,9-12,1	1-8	0,2-3	3,1-4,3	6-8
Palmitová	7,5-10,5	24-30	24-31	25-32	10-20	6-20	22-25	26-32
Stearová	1-3	12-19	21-27	8-12	4-14	5-16	5,2-7	11-15
Palmitolejová	0-1,3	2,3-3,7	1,7-3,0	1,6-5,0	2-6	0-1	4,3-7	2,2-3
Olejová ⁺⁺⁾	5-8	38-46	38-48	26-33	21-55	33-68	41-47	23-28
Linolová	1,5-2,5	4,2-9,4	1,7-2,0	1,0-2,4	6-35	8-22	9-13	4-6
Linolenová	0	0,1-1,3	0-0,2	0-0,5	0-5	0-3	0-1,0	0,5-1,5
Arachidonová	0	0-1,0	0-1,1	0-0,8	0	0	0-0,5	0,4-1
Trans-izomery	0	0-1,0	4-12	5-9 ⁺⁺⁺⁾	6-16	3-20	2-7	2-9
Rozvětvené	0	0-0,2	1-2	1-3 ⁺⁺⁺⁾	0-0,1	0-0,1	0-1	1-2

⁺) pokud neobsahují řepkový olej

⁺⁺⁾ včetně *trans*-izomerů

⁺⁺⁺⁾ odkaz 30

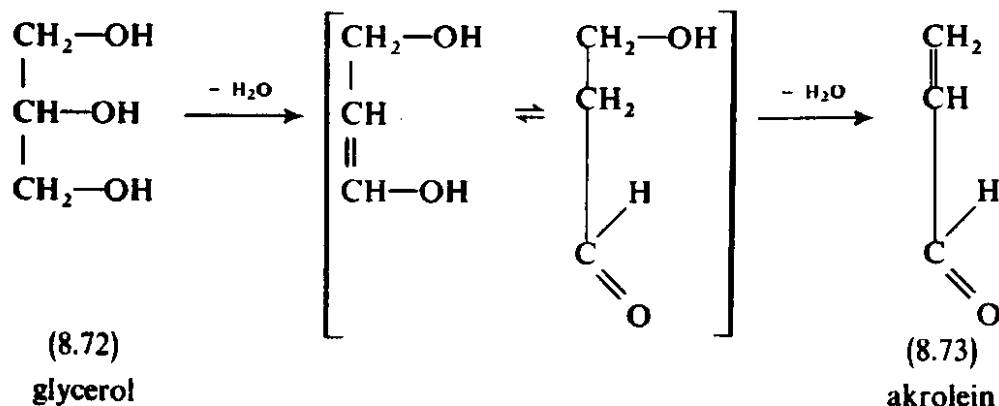
^{*)} hexanová

^{**)} oktanová

^{***)} dekanová

Lůj – surovina pro výrobu svíček

Od starověku byl nejčastěji používán skopový či hovězí lůj, ale bylo možné zvolit jakýkoliv lůj v libovolné směsi. Lojové svíčky velmi rychle hořely a při nesprávném hoření navíc odporně páchly (vznik akroleinu). Při hoření také rychle okapával lůj, a proto mají svícny na lojové svíčky zpravidla okolo středového tuleje širší misku na zachytávání rozteklého loje, mimo jiné i proto, aby bylo možné surovinu znovu použít. U lojových svíček tak velmi záleží na kvalitě loje (od středověku nejčastěji směs skopového a hovězího loje), na způsobu jeho zpracování a na použitém knotu.



Akrolein má ostrý štiplavý zápach, vzniká např. při smažení přepálením tuku.

Identifikace lipidů na základě zastoupení MK

Kyselina eruková (Z-13-dokosenová kyselina): ve značném množství je obsažena v tuku semen některých rostlin, například hořčice a řepky (Brassicaceae, brukvovité). Má nepříznivý vliv na živý organismus.

Kvantitativní analýza artefaktů

Index nasycenosti (Saturation index, SI; Loy 1994)

$$SI = 1 - [(C18:1 + C18:2)/(C12:0 + C14:0 + C16:0 + C18:0)]$$

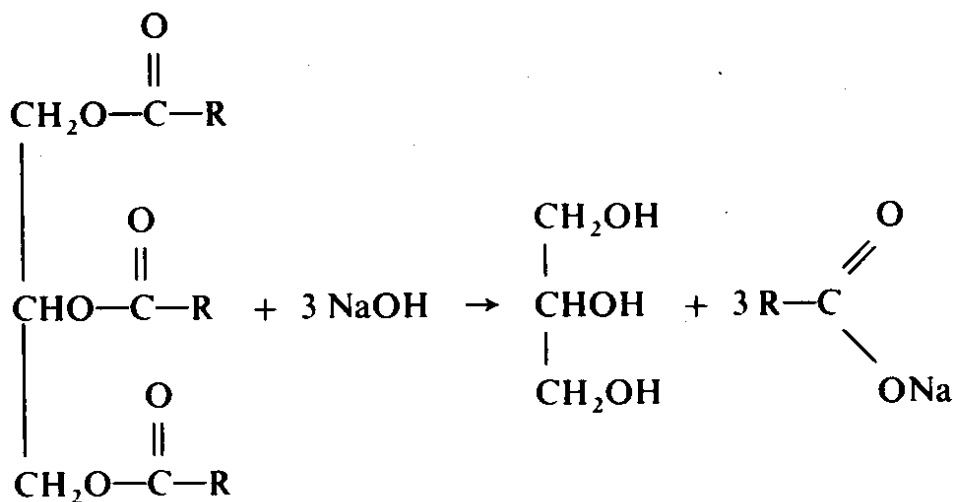
Procenta nasycených MK (%S; Marchbanks 1989)

$$\%S = (C12:0 + C14:0)/(C12:0 + C14:0 + C18:2 + C18:3)$$

Použití C16:0 a C18:0 není podle autora vhodn, protože jejich zastoupení se mění s dekompozicí. C18:2 a C18:3 jsou zahrnuty, protože jsou charakteristické pro rostlinný materiál.

Saponifikace (zmýdelnění)

Mýdla se původně vyráběla vařením živočišného tuku s potaší (K_2CO_3) louhovanou z popela. Proces byl velmi pomalý. Rozvoj výroby byl zaznamenán v 18. století díky využití kaustické sody získané Leblancovým postupem. Sodná a draselná mýdla jsou ve vodě disociovatelná, mají detergenční vlastnosti.



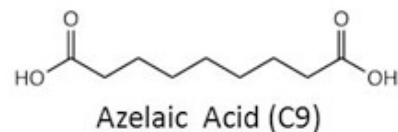
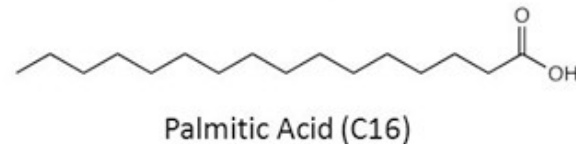
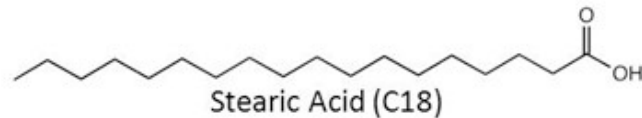
(4.58) zmýdelňování tuků



Vápenatá a hořečnatá mýdla jsou ve vodě nerozpustná (viz. adipocire)

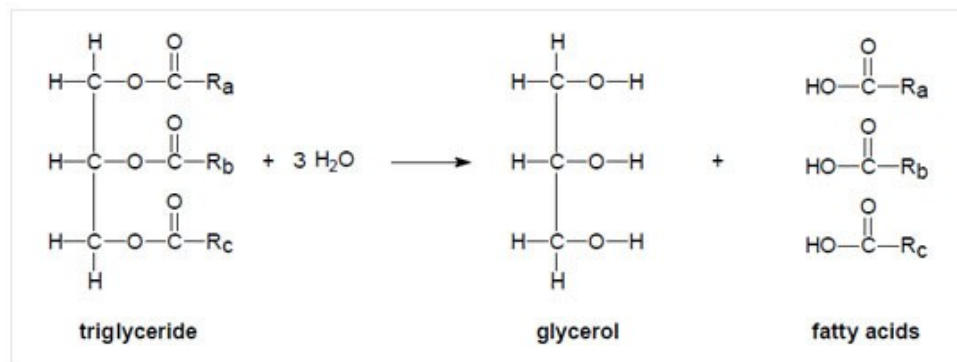
Karboxyláty („mýdla“) těžkých kovů

1. Předpokládá se vznik interakcí rostlinných olejů a minerálních pigmentů v olejomalbách (Pb, Zn).
2. Vznik v místech kontaktu korozních produktů (Cu, Zn) s organickým materiálem (tuk, olej, kůže)
3. Záměrná příprava (konzervace a úprava povrchů; Fe, Cu, Zn, Al) – vznikají aplikací alkalických karboxylátů



Kyselá hydrolýza

Hydrolýza glyceridů na volné mastné kyseliny + alkohol (glycerol, steroly, ...),



= klasická chemická hydrolýza je velmi pomalý děj (tuk nerozpustný ve vodě)

„*Stearinový vosk*“ = směs nasycených a nenasycených volných MK. Počátkem 19. století byly získávány působením minerálních kyselin na mýdla, později katalytickou hydrolýzou kyselinami za atmosférického tlaku (Twitchellův proces) nebo za zvýšené teploty (216 °C) a tlaku.

Použití: některé druhy svíček (kostelní svíčky, ...).

Anaerobní oxidace - mikrobiální

OH: *Bacillus subtilis*, *Clostridium perfringens*, *Micrococcus luteus*

Oxo: *Micrococcus luteus*

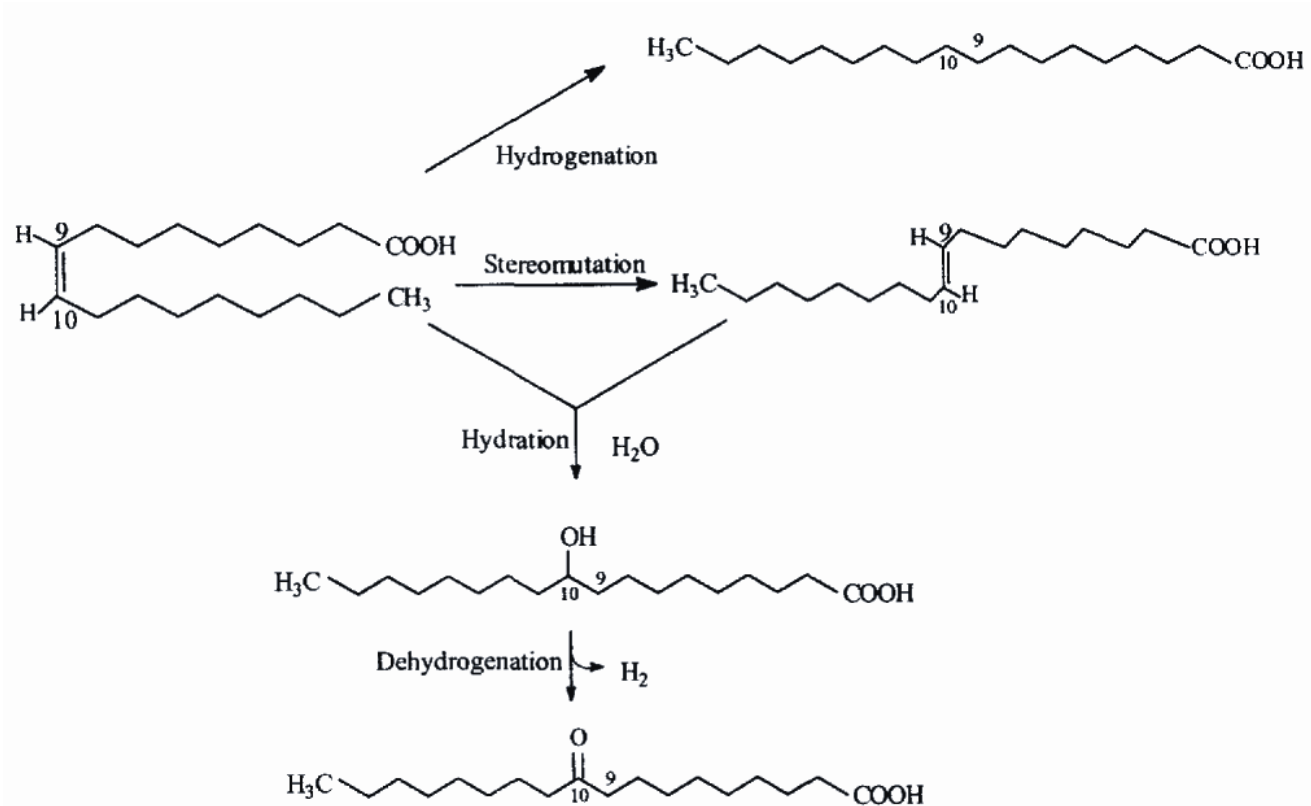


FIG. 6—Chemistry of microbial degradation of oleic acid during adipocere formation.

Anaerobní oxidace - mikrobiální

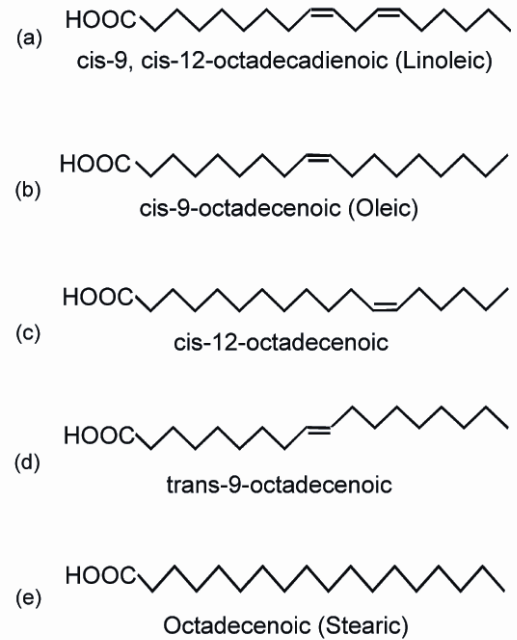
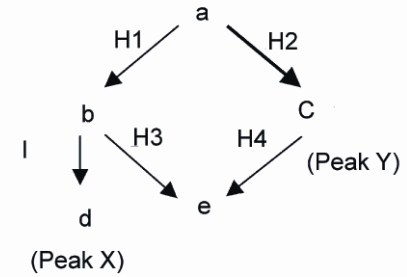
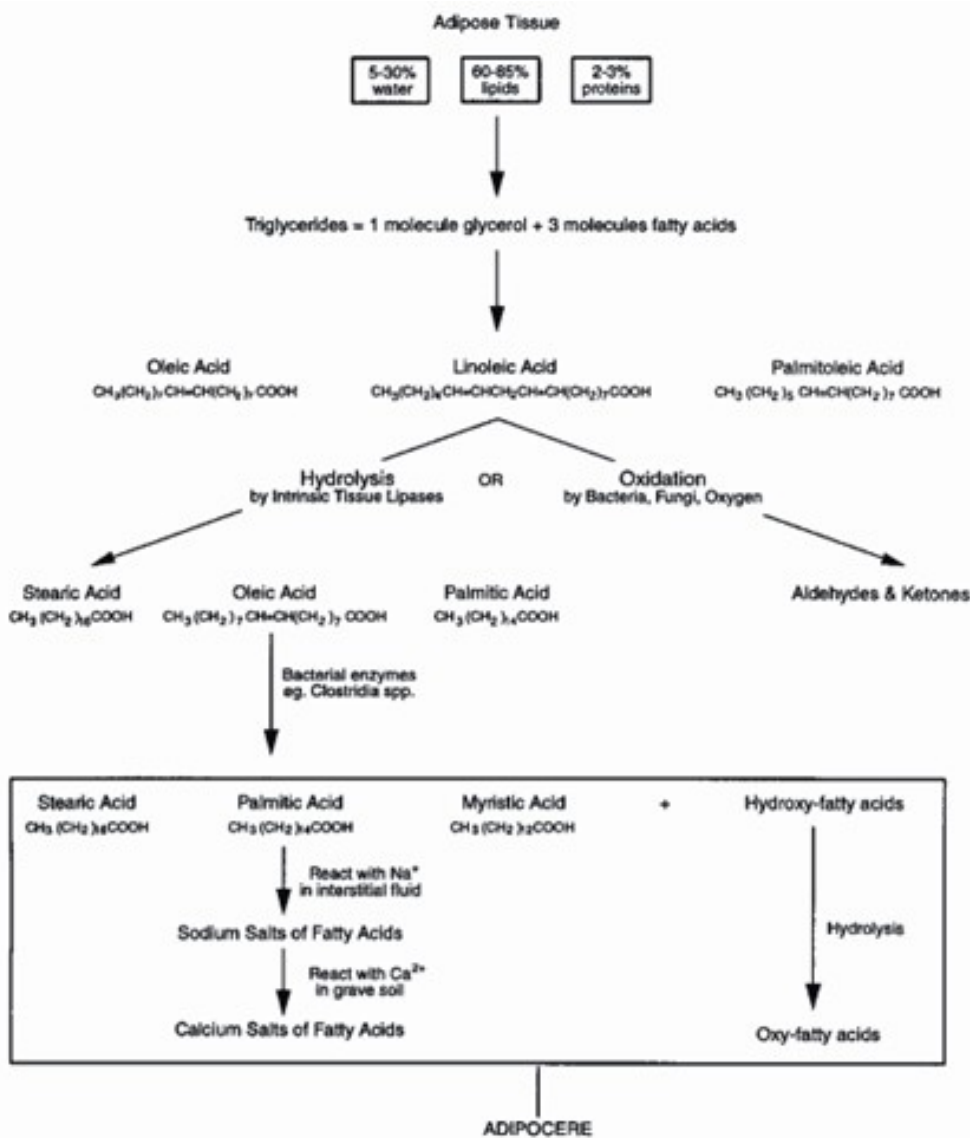


Fig. 5. Putative pathway from octadecadienoic acid to octadecenoic acid or octadecanoic acid.

Produkty anaerobní oxidace

„bog butter“

máslo v dřevěné nádobě bylo
zakopáno do rašeliniště
(= způsob konzervace)



Mrtvolný vosk (adipocire)

„Brienzi“, jez. Brienz
(Švýcarsko)
cca 1700 n. l.



Tomašica, hrom. hrob
(Bosna a Hercegovina)
1992



Zmýdelnění (saponifikace)

vzniká adipocire
(mrtvolný vosk)

Hydrogenace kyseliny olejové
na stearovou a linoleové na
palmitovou

Oxidace kyseliny olejové na
hydroxystearovou a
oxostearovou

Vznik solí mastných kyselin
(Na^+ , K^+ a Ca^{2+})

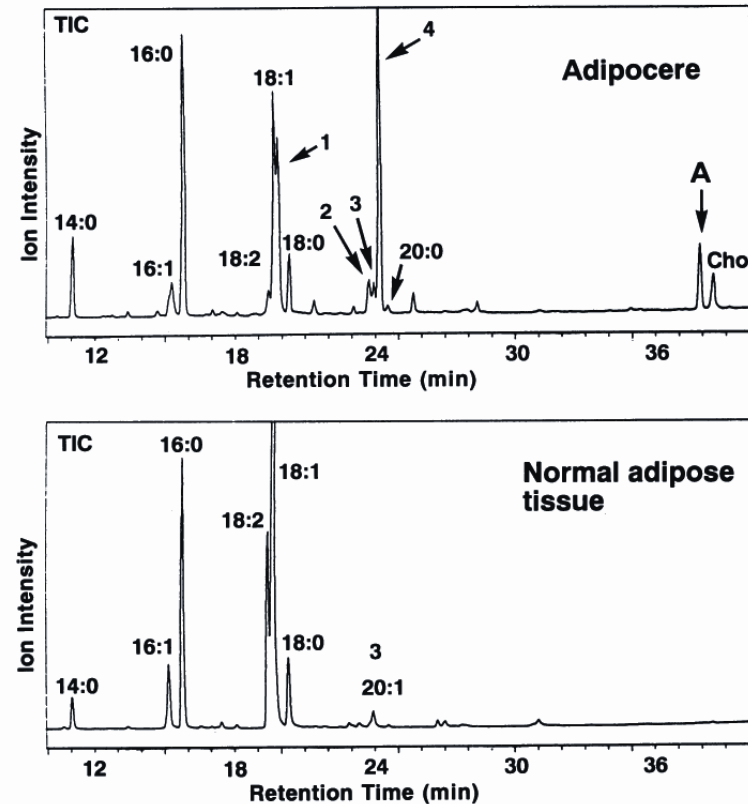


FIG. 1. Total ion chromatograms (TIC) for adipocere and normal adipose tissue (control). 1, 10-Hydroxyhexadecanoic acid (10-OH 16:0); 2, 10-ketooctadecanoic acid (10-keto 18:0); 3, eicosenoic acid (20:1); 4, 10-hydroxyoctadecanoic acid (10-OH 18:0); A, epicoprostanol; Cho, cholesterol.

St. Bees Man

- mrtvý je pravděpodobně rytíř Anthony de Lucy († 1368)
Saponifikované tělo se dochovalo díky vysoké vlhkosti půdy.



Cimetière des Innocents

Adipocire poprvé charakterizoval chemik Antoine Francois de Fourcroy, který jej zjistil na pozůstatcích ze hřbitova Neviňátek v Paříži. Dlouholetý hřbitov byl 1780 z hygienických důvodů (kvůli nesnesitelnému zápachu) zrušen. Od roku 1785 je na místě hřbitova park.



Antoine Francois de Fourcroy



154

ANNALES

M É M O I R E

Sur les différens états des Cadavres trouvés dans les fouilles du cimetière des Innocens en 1786 & 1787 ;

Lue à l'Académie Royale des Sciences les 20 & 28 mai 1789 (a) ;

Par M. DE FOURCROY.

LA physique a partagé les soins de l'administration dans les travaux faits au cimetière des Innocens. Elle étoit spécialement chargée du

(a) Ce mémoire n'est qu'une esquisse légère d'une suite de phénomènes importants sur la décomposition des corps qui ont été observés dans les fouilles de l'ancien cimetière des Innocens, devenu aujourd'hui une des plus belles places & un des plus beaux marchés de la capitale. Ces phénomènes n'y font indiqués, que d'une manière générale. M. Thouret, médecin, qui a suivi ces fouilles avec un zèle & une ardeur infatigable pendant deux ans, a recueilli un grand nombre de faits qu'il doit publier dans un ouvrage parti-

Cca 1000 let starý tuk ze zmrzlého odpadu v oblasti Yukonu

Lokalita Thule (Herschelův ostrov)

Materiál obsahoval poměrně významný podíl nenasycených MK. Nízká teplota nedovolila významnější mikrobiální aktivitu, většina MK byla volných (jednoduchá hydrolýza ve vlhkém prostředí).

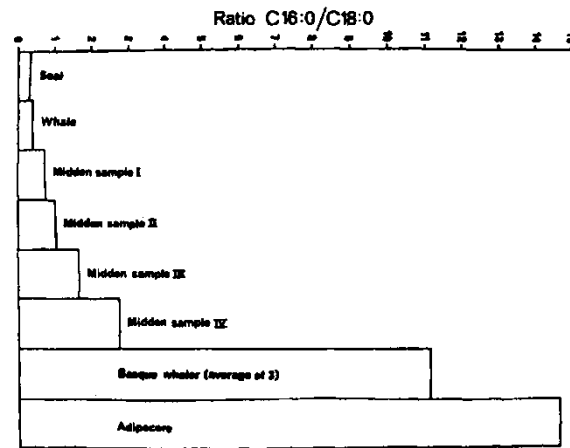
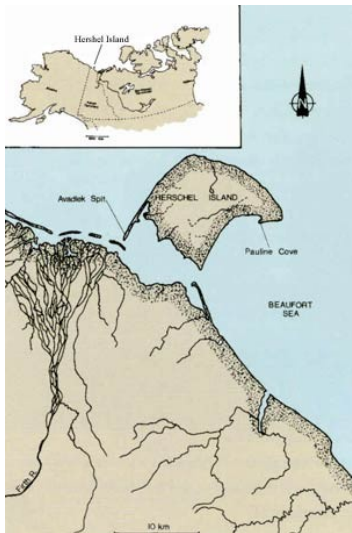


FIG. 4. Histogram showing ratio of palmitic acid (C16:0) to oleic acid (C18:1) for various substances, including unpublished results of fatty material from a Basque whaling station excavated at Red Bay, Labrador.

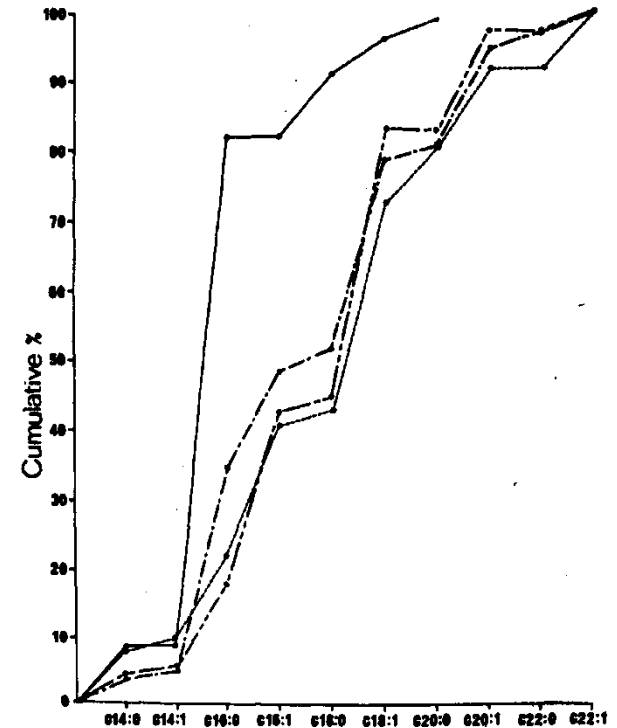


FIG. 5. Cumulative percentage fatty acid composition plots of various materials, showing apparent similarity of midden samples (means of samples I, II, and III of this study) to average for three seal species and average for whales (data taken from Table 4). Adipocere —, midden samples I, II, III ----, average seals ·····, average whales -·-·-.

Srovnání adipociru různého stáří

Pozůstatky mrtvol různého stáří z téhož prostředí (jezero Walchensee; Bavorsko)

Roste relativní podíl kyseliny palmitové, klesá zastoupení kyseliny olejové a klesá poměr olejová/palmitová z cca 50/25 pro recentní materiál na 0/90 pro materiál 100 let starý.

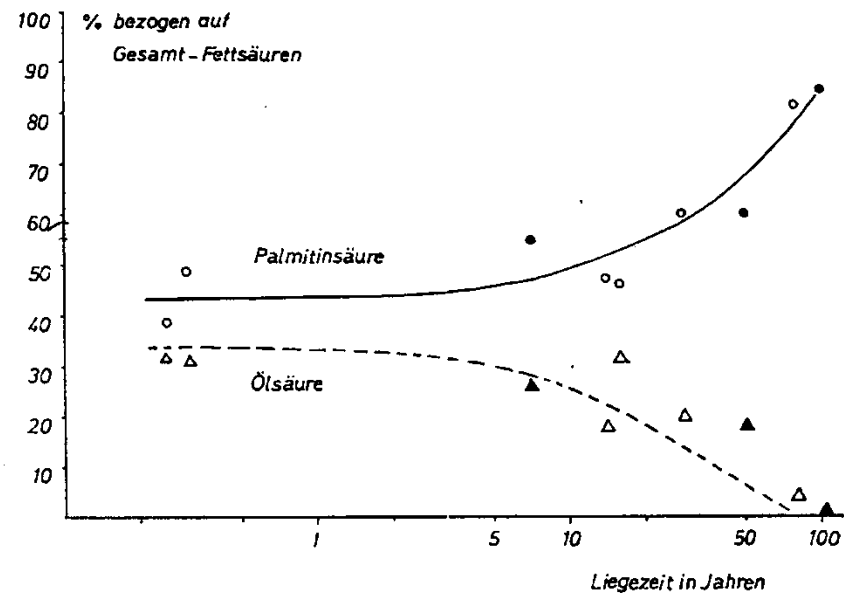
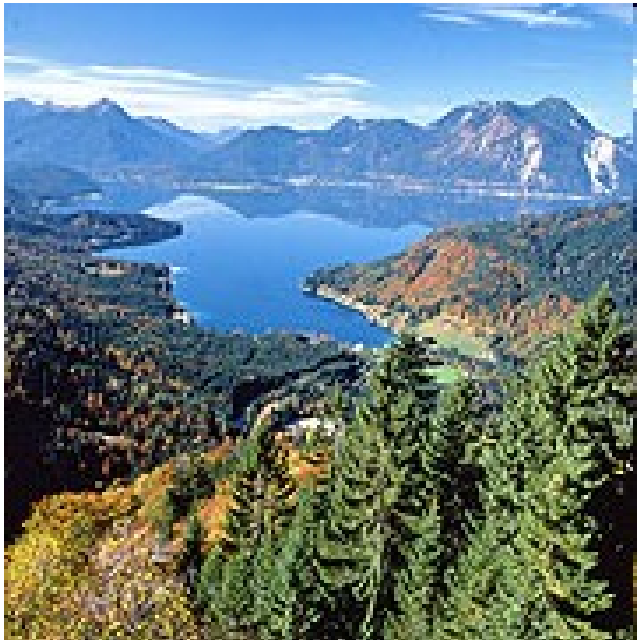
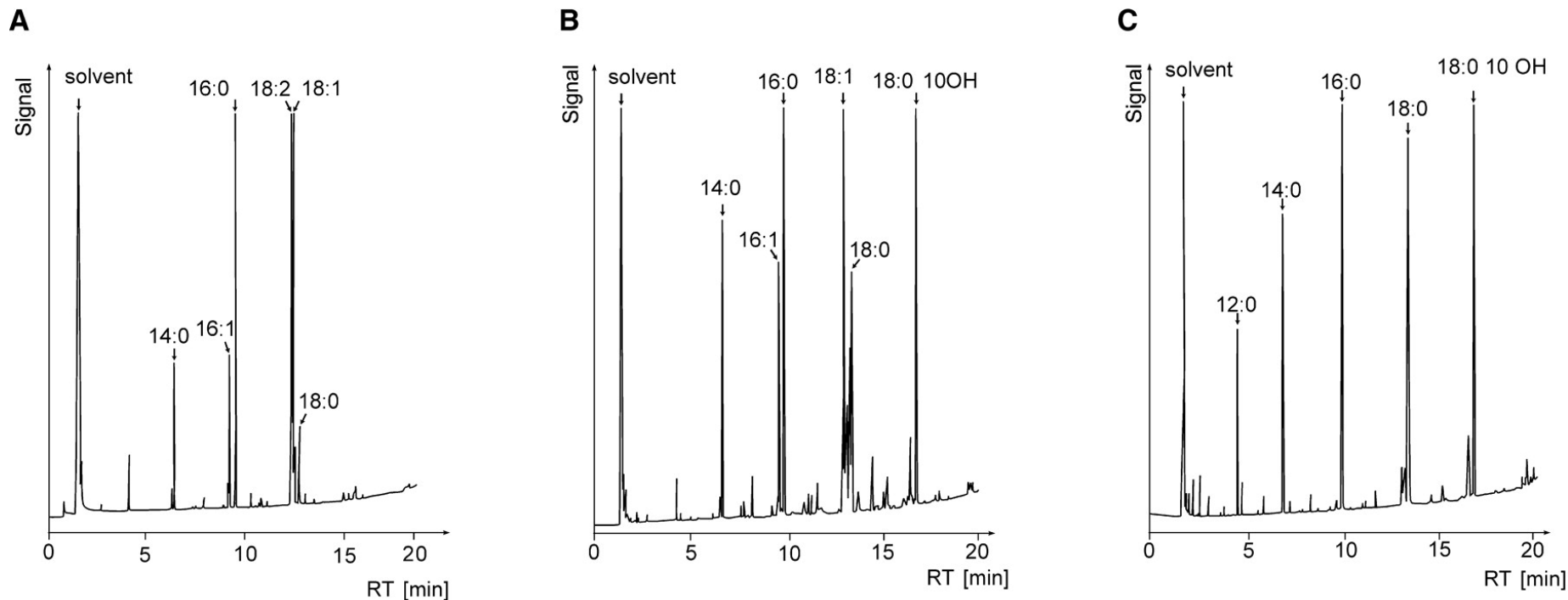


Abb. 1. Änderung des Palmitin/Ölsäure-Anteils in Fettwachs-Proben mit zunehmendem Alter.
○ = Palmitinsäure, △ = Ölsäure, ●, ▲ = Werte der 3 Walchensee-Leichen.

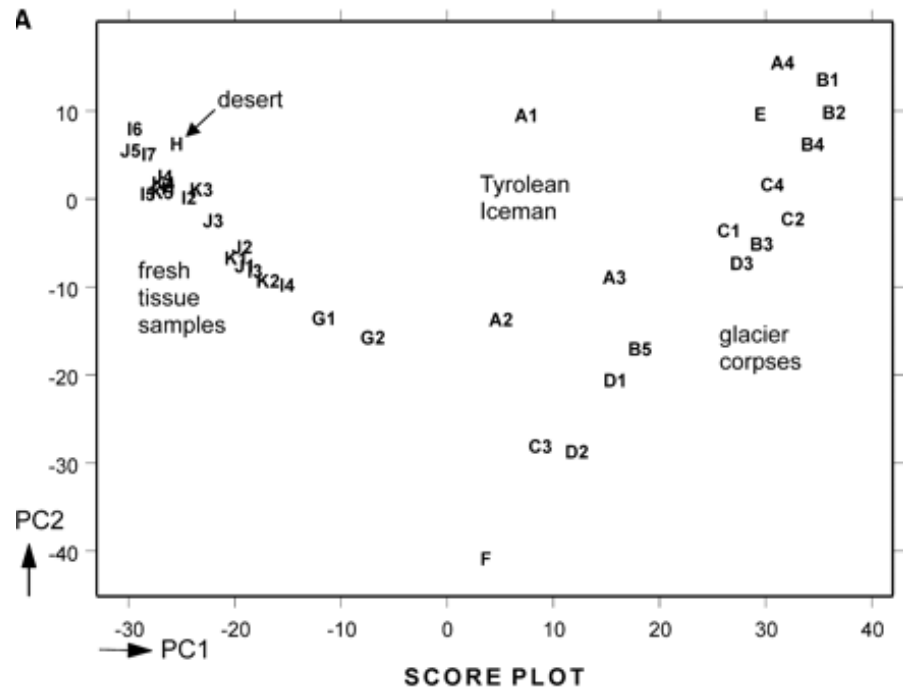
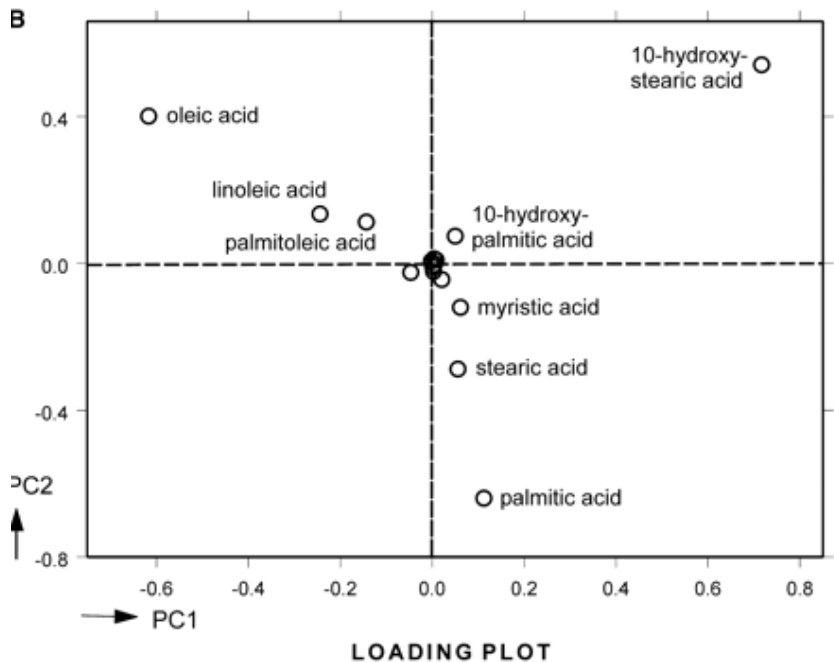
Adipocire z různého prostředí



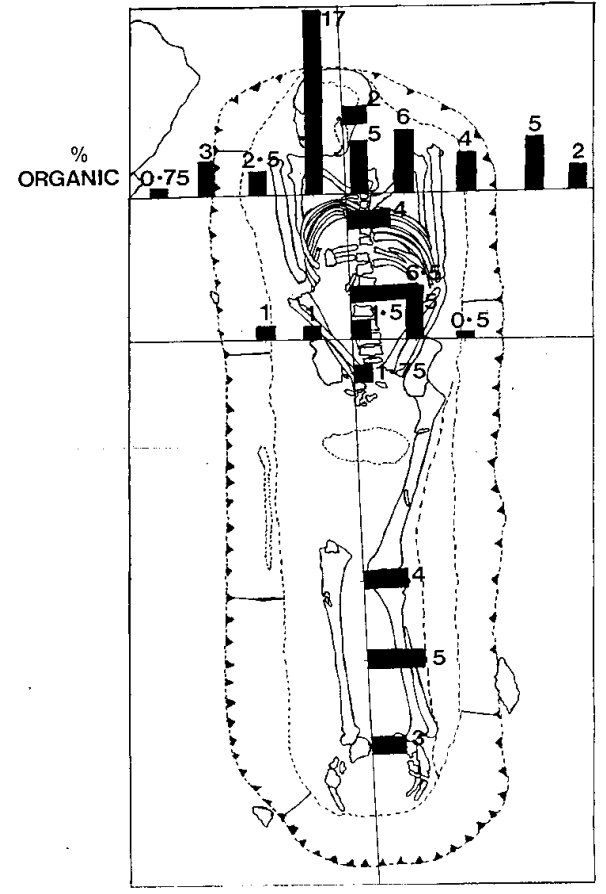
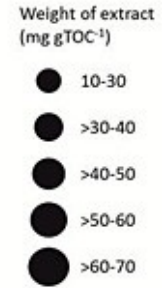
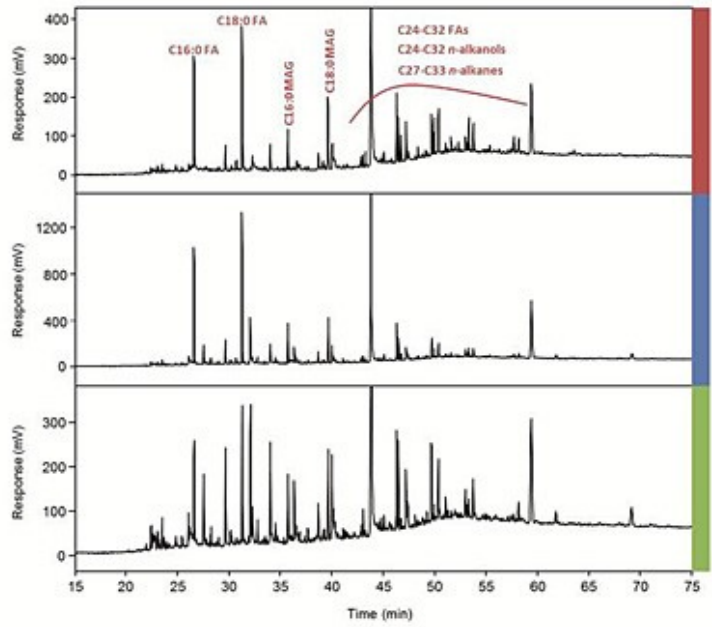
Profil mastných kyselin čerstvé a mumifikované tkáně analyzovaný plynovou chromatografií, který ukazuje větší příbuznost vzorku mastných kyselin Tyrolského ledového muže s čerstvou tkání než s jinou ledovcovou mrtvolou: A, kůže s připojeným tukem z čerstvé lidské mrtvoly; B, trabekulární kost tyrolského ledového muže (doba pohřbu: přibližně 5 000 let); C, játra získaná z mrtvoly pohřbené v ledovci Madatschferner (doba pohřbu: 29 let). Mastné kyseliny jsou označeny takto: 12:0, kyselina laurová; 14:0, kyselina myristová; 16:0, kyselina palmitová; 16:1, kyselina palmitolejová; 18:0, kyselina stearová; 18:1, kyselina olejová; 18:2, kyselina linolová; 18:0 10OH, kyselina 10-hydroxy stearová.

Adipocire z různého prostředí

- A Otzi cca 5200 let
- B Glacier Madatschferner 29 let
- C Glacier Sulztalferner 57 let
- D jezero Achensee 30 let
- E, F Altaj cca 2500 let
- F Mount Ampato, Peru, cca 500 let
- G Ilo, poušť, Peru, cca 1000 let
- I- K recent



Obsah organické složky v okolí skeletu



TOC
Lipidy
Cholesterol

Figure 4. Schematic organic content of sand.

Aerobní oxidace

mechanismy zahrnují produkci hydroperoxidových intermediátů radikálovými procesy:

přímé štěpení dvojné vazby
 hydratace a následné štěpení
 ω -oxidace s následujícím štěpením dvojné vazby
 ω -oxidace, hydratace a následné štěpením dvojné vazby

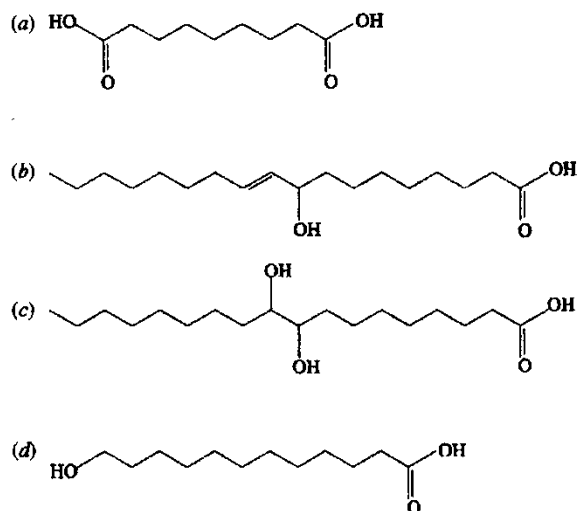


Figure 3. Structures of various fatty acid oxidation products found in the saponified residue of a neolithic potsherd (see figure 2). Structural identifications: (a) C₉ α,ω -dicarboxylic acid or nonanedioic acid (azelaic acid); (b) 9-hydroxyoctadecanoic acid; (c) 9,10-dihydroxyoctadecanoic acid; (d) ω -hydroxydodecanoic acid.

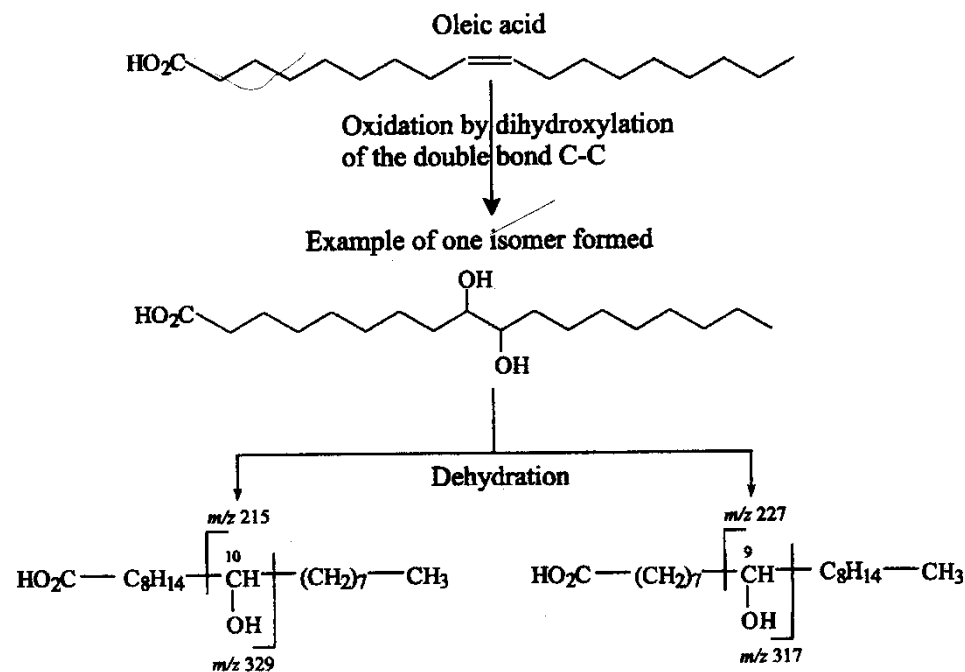


Figure 4. One proposed degradation pathway for the formation of unsaturated hydroxy acids. The m/z values correspond to the fragment ions of the bis-TMS derivatives.

Aerobní oxidace

- 10-hydroxyoktadekanová kyselina = hydratace C=C vazby olejové kyseliny
- 9,10-dihydroxyoktadekanová kyselina = oxidace C=C dihydroxylací
- α,ω -dikarboxylové kyseliny (C7 – C12), dominantní složkou je azelaová kyselina (C9), oxidativní degradace C=C

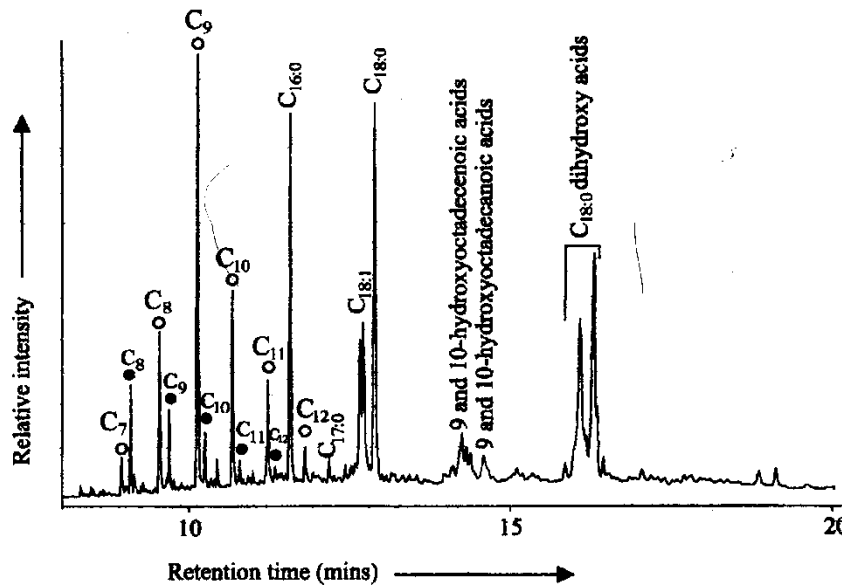
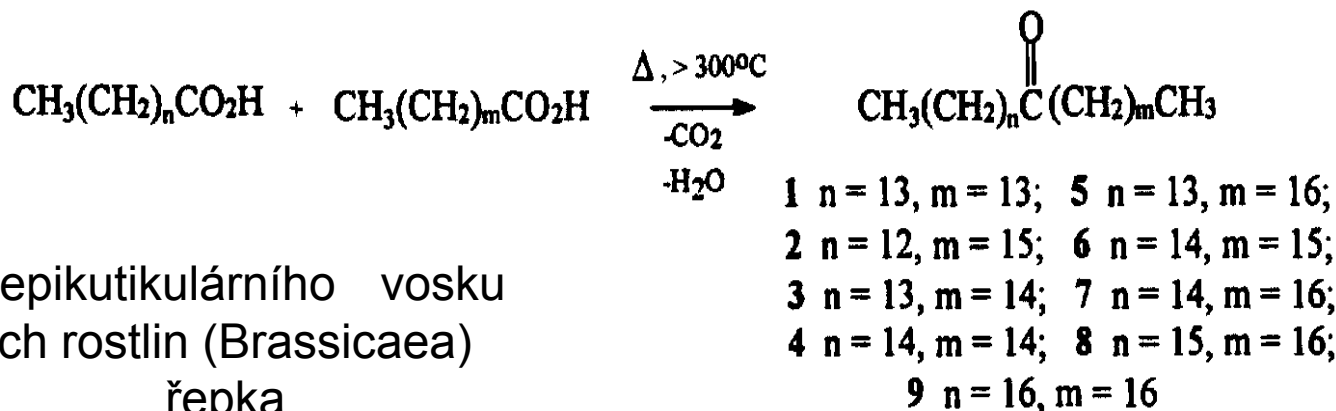


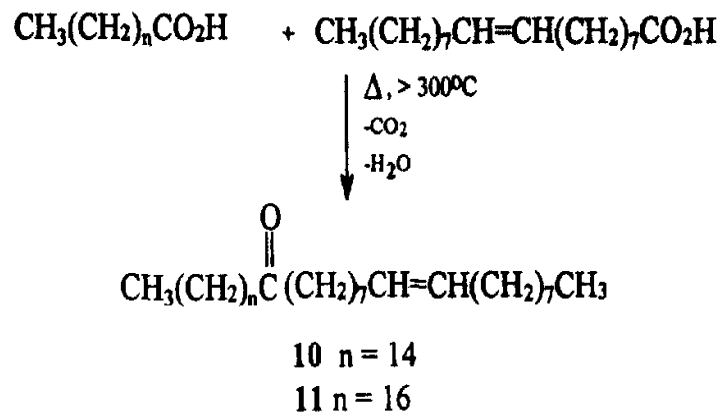
Figure 2. Partial gas chromatogram of the base treated residue (as methyl ester-trimethylsilyl ether derivatives) of a potsherd from a neolithic cooking vessel. Peak identities: C_{16,0}, C_{18,0}, etc., indicate saturated fatty acids; C_{18,1} indicates monounsaturated fatty acid; ○C_x indicates α,ω -dicarboxylic acids with carbon chain length x ; ●C_x indicates ω -hydroxy acids with carbon chain length x .

Ketony s dlouhými alkylovými řetězci

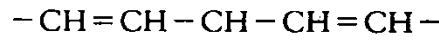
= kondenzační produkty mastných kyselin v archeologickém materiálu



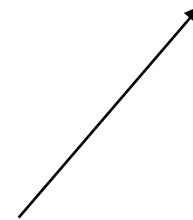
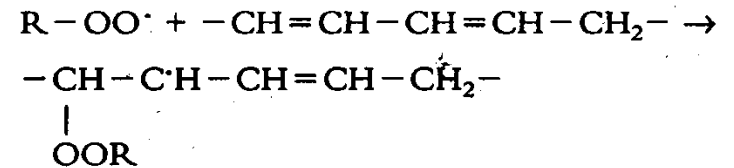
Součást epikutikulárního vosku
 brukvovitých rostlin (Brassicaea)
 řepka
 kapusta



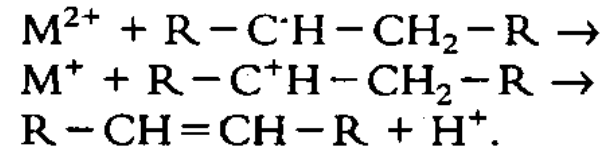
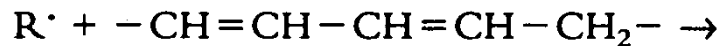
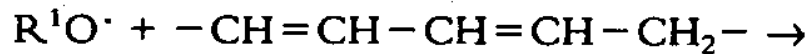
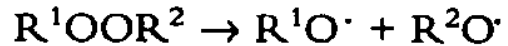
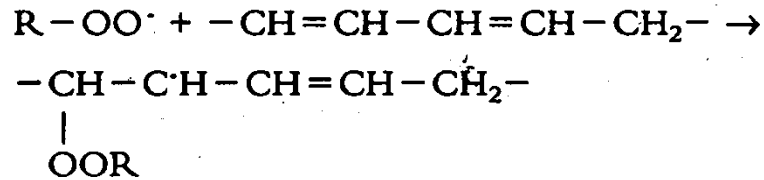
Vysychání olejů = autooxidace tuků



Lněný olej vysychá poměrně rychle za tvorby elastického, většinou žlutě až hnědě zbarveného filmu.

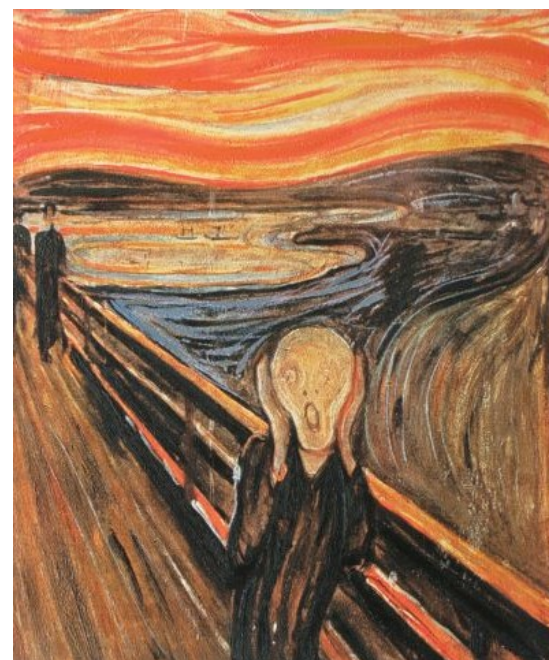


Vysychání olejů



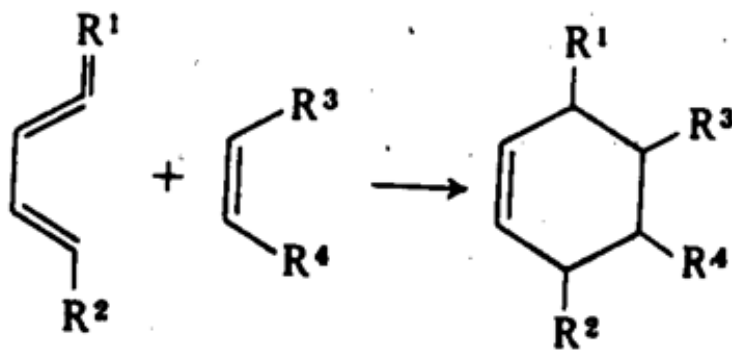
Aplikace olejů v malířství

Olejomalba začíná cca ve 14. století, plně se vžila v 16. století. Pojivem barev jsou vysychavé oleje (lněný, makový, ořechový) a oleje tepelně či jinak upravené. Olejové pojivo ovlivňuje mechanické a optické vlastnosti barevného filmu a v největší míře podléhá vlivům stárnutí a působení vnějšího prostředí



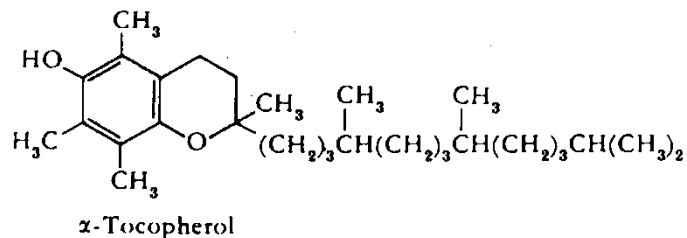
Prepolymerizované (zahuštěné) oleje, „stand oil“

Staří holandské mistři připravovali tzv. „stand oil“ zahuštěním jiného oleje pod inertní atmosférou spalin, vzniklých zapálením těkavých látek, uvolňujících se při zahřívání oleje nad 300 °C.



Dimerace Diels-Alderova typu, linolová a/nebo linolenová kyselina; konjugovaný systém vzniká izomerací nekonjugovaných dvojných vazeb. Produkt dimerace má jednu dvojnou vazbu – ta reaguje s dienem za vzniku trimeru.

Ovlivnění rychlosti vysychání



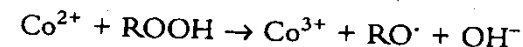
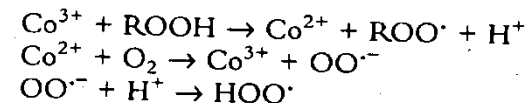
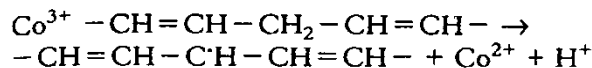
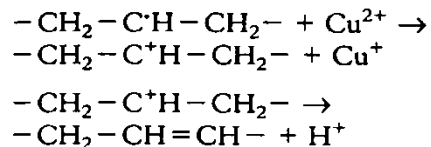
- Antioxidanty

přírodní: α-tokoferol

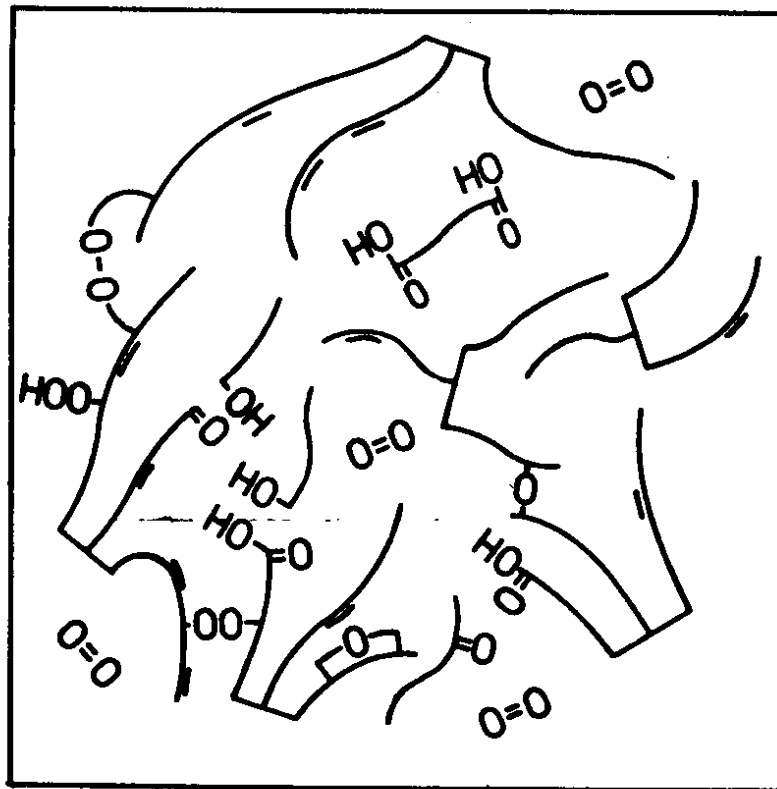
umělé: produkty pyrolýzy (uhlíková čern), biuminózní zeminy (Vandyckova hněd')

- Těžké kovy

= katalyzátory rozkladu hydroperoxidu na radikály



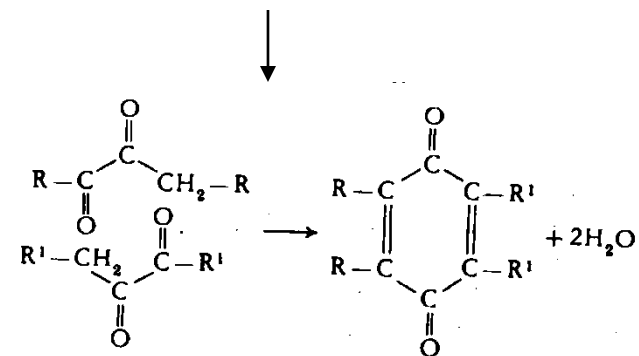
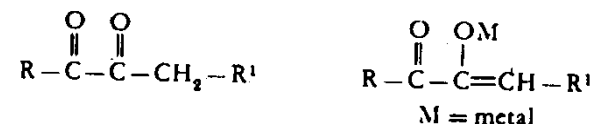
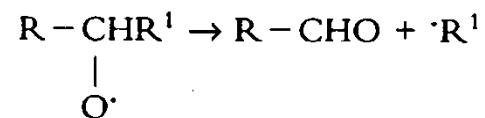
Degradace olejových filmů



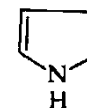
Obr. 16 Schematické znázornění oxidace a degradace filmu lněného oleje¹⁹. $O=O$... kyslík, $-OOH$... hydroperoxid, $-OH$... alkohol, $-COOH$... kyselina.

Degradace olejových filmů

Štěpení alkoxyradikálů za vzniku aldehydu, který může podléhat další oxidaci – mohou tak vznikat dikarboxylové kyseliny (pokud R = glycerylester)



Žloutnutí filmu



pyrrole

Stand oil vysychá mnohem pomaleji než lněný olej, má vyšší viskozitu, nižší jodové číslo, díky C-C vazbám je film trvanlivější, má větší optickou stálost, nižší sklon ke žloutnutí a objemovým změnám během vysychání.

Tabulka 8 Vlastnosti původního lněného oleje a olejů zahuštěných

Vlastnosti	Původní olej	Oleje zahuštěné při 300 – 305 °C		
		pod atm. par ⁷	pod vakuem ⁸	pod CO ₂ ⁸
index lomu ¹	1,4800	1,4906	1,4907	1,4920
hustota (kg/m ³) ¹	929,1	966,1	966,2	972,6
viskozita (Pa s) ¹	0,0246	7,950	8,535	47,891
číslo kyselosti (mg KOH/g) ^{1, 2}	0,1	16,0	11,4	11,5
číslo zmydlnění (mg KOH) ^{1, 3}	190	190	187	192
Hanušovo jodové číslo (% J ₂ /g) ^{1, 4}	185,5	55,5	50,0	69,0
obsah peroxidů za horka (μg/g) ¹	40	4	10	18
číslo barevné stupnice (mg J ₂ /100 ml) ⁵	5	5	4	5–7
číselná molekulová hmotnost ⁶	649	1184	1342	1803

¹ – Stanoveno dle ČSN 58 0101.

² – Číslo kyselosti vyjadřuje množství volných mastných kyselin.

³ – Číslo zmydlnění udává množství hydroxidu draselného nutného k neutralizaci volných mastných kyselin a dále k zmydlnění tuku.

⁴ – Jodové číslo charakterizuje nenasycenost tuku.

⁵ – Stanoveno dle ČSN 67 3011.

⁶ – Stanoveno osmometrií v parní fázi.

⁷ – Způsob přípravy napodobující v laboratorních podmínkách technologii starých mistrů.

⁸ – V laboratorních podmínkách provedené současné průmyslové technologie.

Steroly a stanoly

Substituční skupiny se připojují pod rovinou kruhu (α ; k zobrazení se používá přerušovaná čára) nebo nad rovinou kruhu (β ; k zobrazení se používá plná čára). Kruh 5 α steroidů je vzhledem ke kruhu B vždy trans, u 5 β steroidů vždy cis. Methyly připojené k C10 a C13 jsou vždy v konfiguraci β .

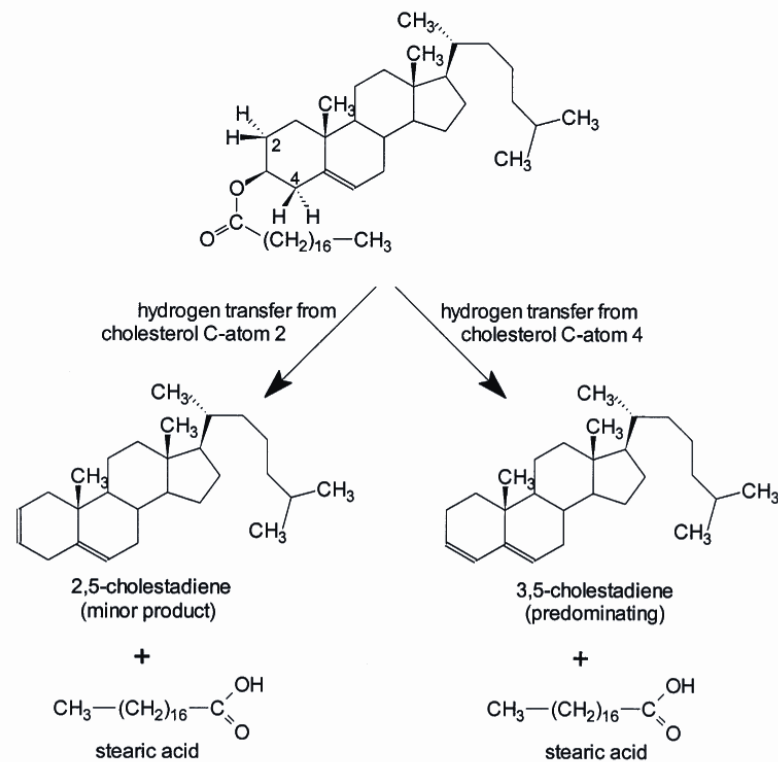
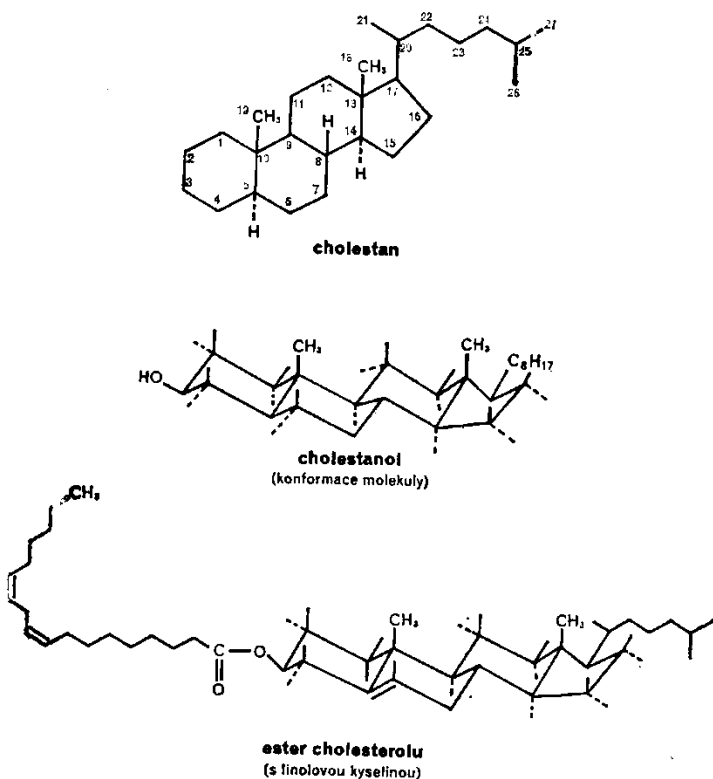
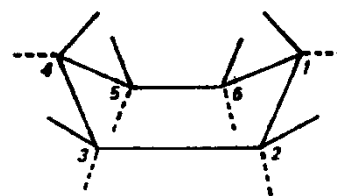


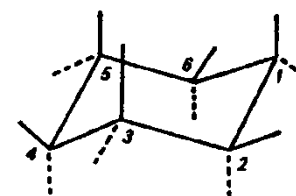
Fig. 3. Proposed thermal degradation scheme for cholesteryl stearate.

Steroly a stanoly

U přirozeně se vyskytujících steroidů jsou všechny šestičlenné kruhy v židličkové konformaci (je stabilnější).

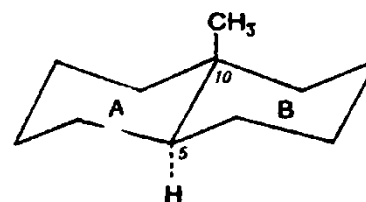


vaničková forma

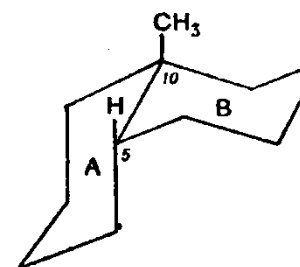


židličková forma

Vzájemně mohou být kruhy v poloze cis nebo trans (BC a CD jsou vždy trans).

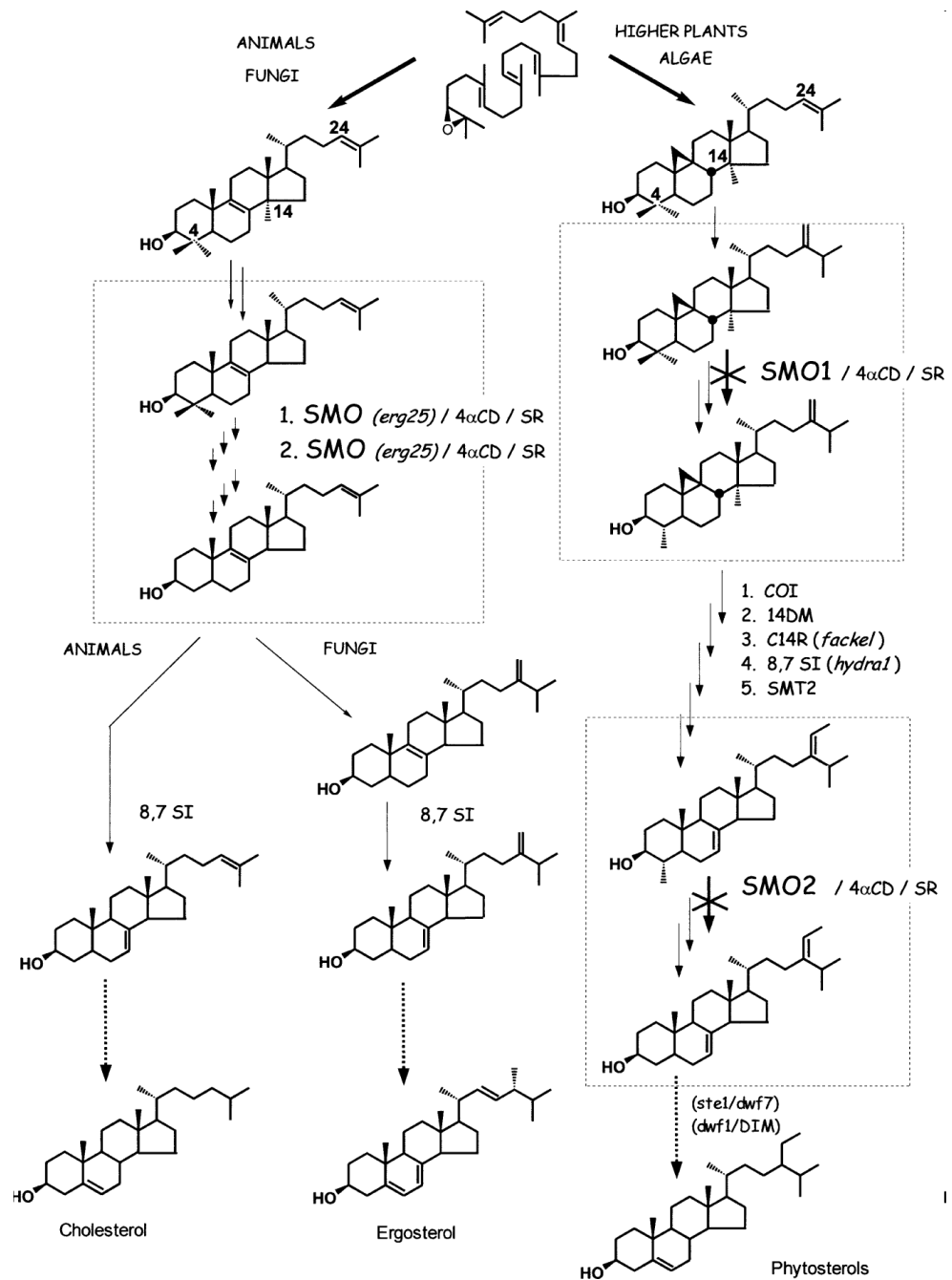
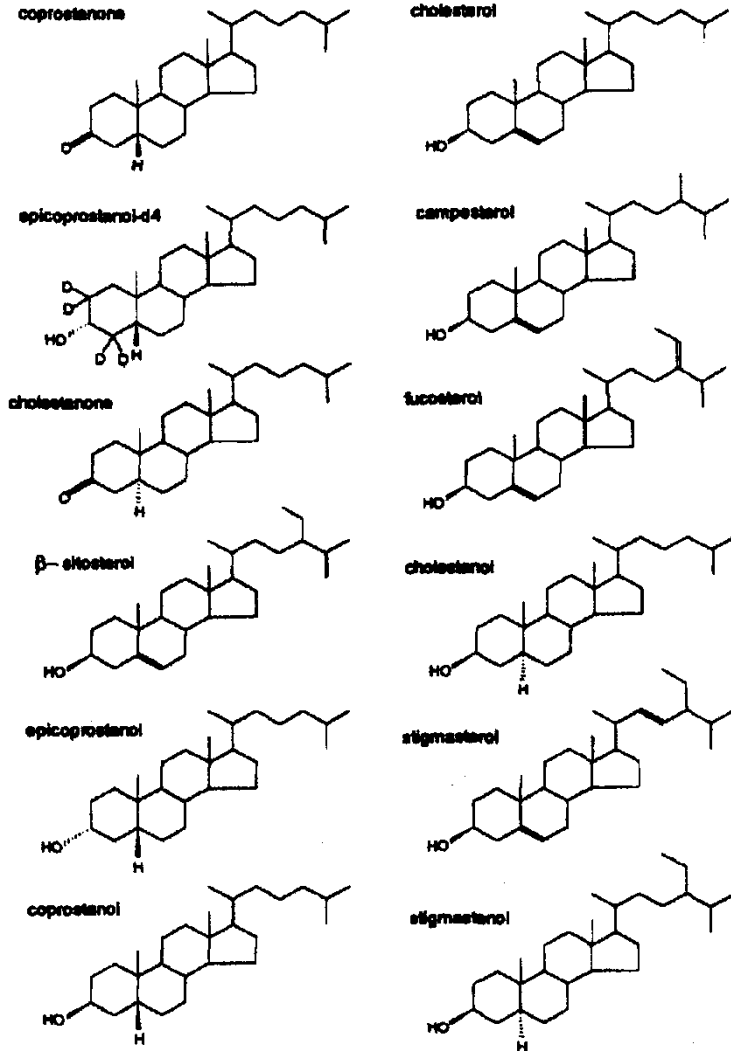


trans-uspořádání

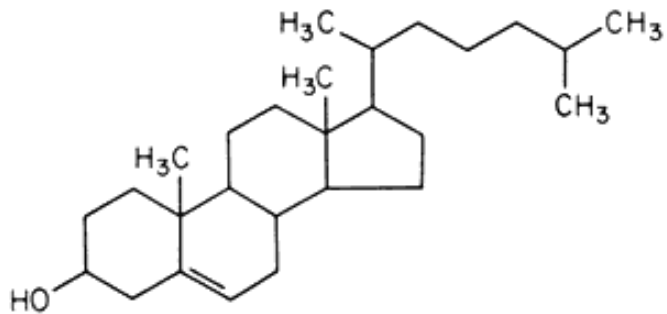


cis-uspořádání

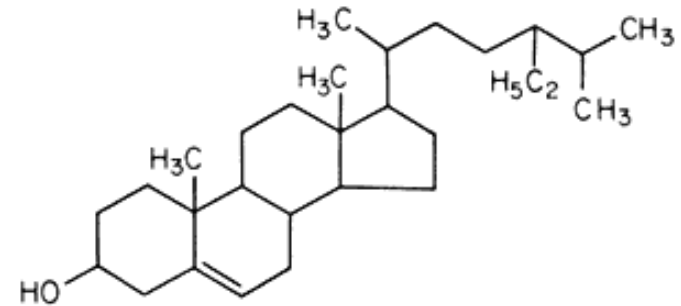
Steroly a stanoly



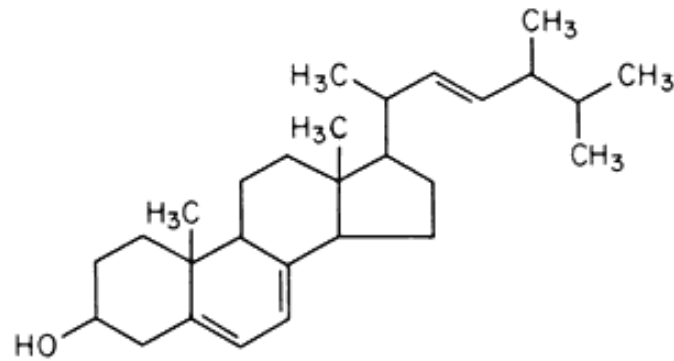
Steroly - biomarkery



Cholesterol



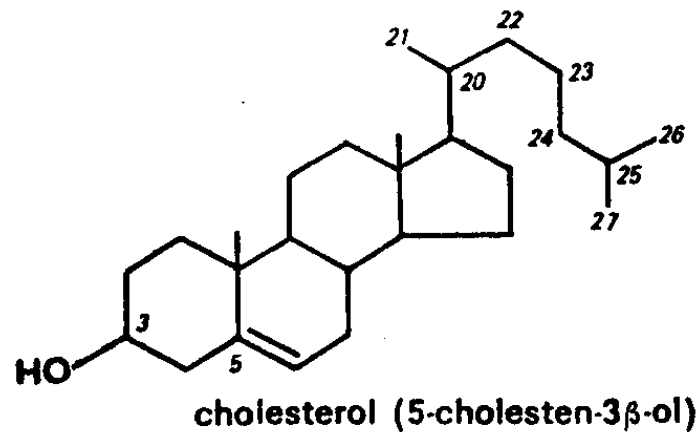
β -Sitosterol



Ergosterol

Cholesterol

Specifický pro živočišnou tkáň



Detekce v půdě:

přítomnost pozůstatků v hrobě, zpracování masa

Detekce v malbách:

vysoký obsah cholesterolu indikuje přítomnost vejce, nespolehlivé (degraduje)

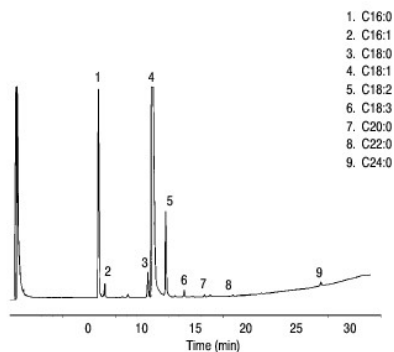
Palivo v římských kahanech

Odhad na základě poměru mastných kyselin (MK) selhává díky oxidaci dvojně vazby na kyselině olejové

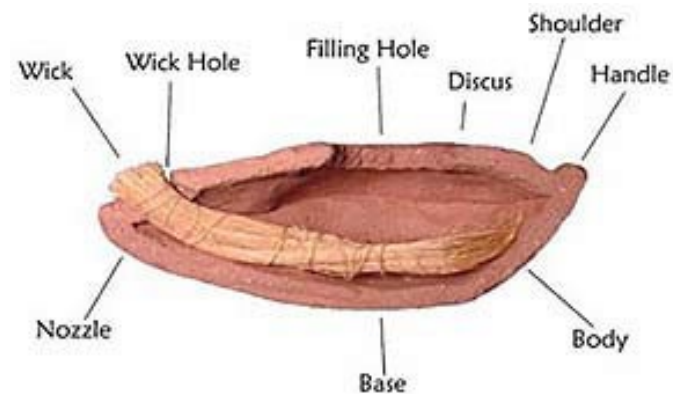
Rostlinné oleje (olivový) – fytosteroly, vyšší obsah kyseliny olejové

Živočišný tuk (lůj) – cholesterol, vyšší obsah kyseliny stearové

Greek Olive Oil (Methyl Ester)



GC: 6890
Carrier: Helium, constant flow 46.6 psi
Column: HP-INNOWax, 30 m x 0.25 mm x 0.25 μ m (Part No. 19091N-133)
Inlet: 1.5 μ l, 260°C, deactivated liner with glass wool
Oven: 150°C (1 min), 2.9°C/min 230°C (1 min)
Detector: FID 260°C



Steroly a stanoly

Fekální biomarkery

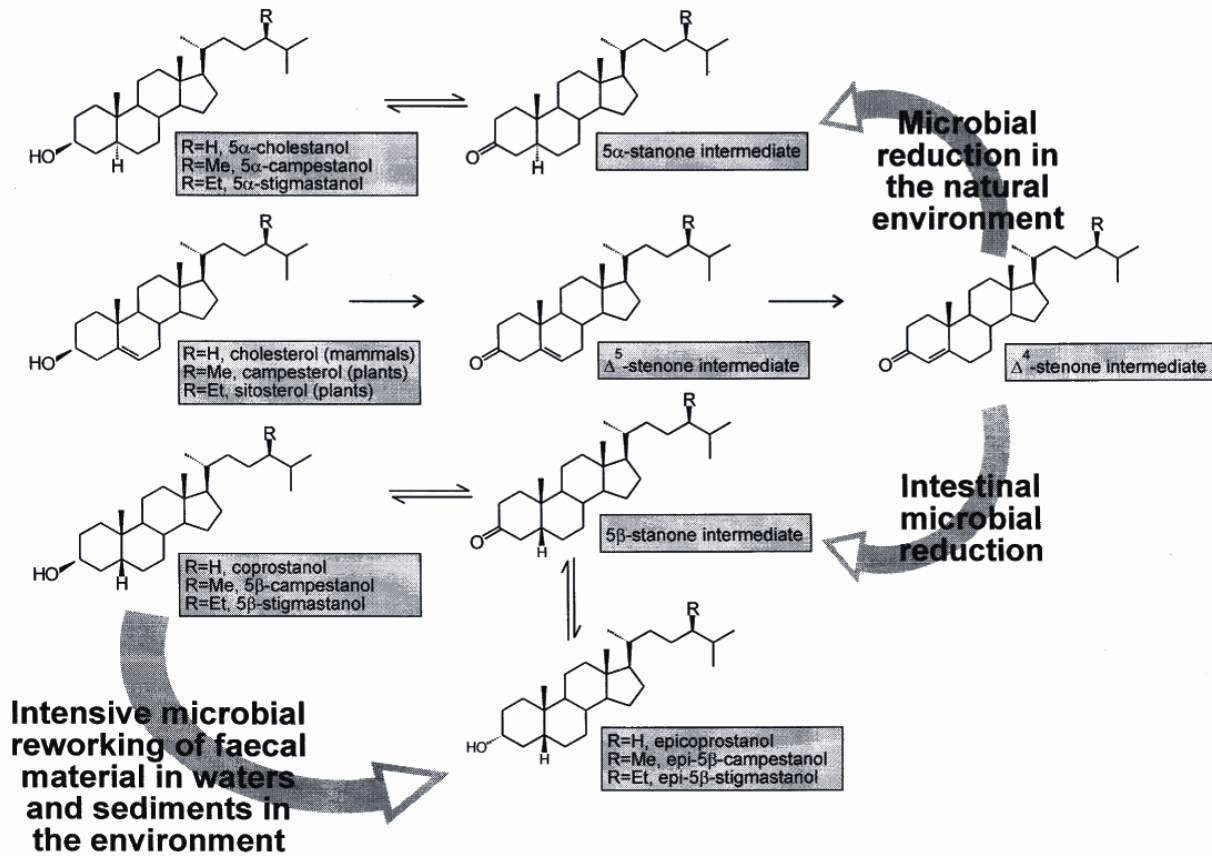


Fig. 1. A schematic detailing the formation of 5 α - and 5 β -stanols, from their steryl precursors, in the natural environment and the mammalian gut.

Žlučové kyseliny

Deriváty cholesterolu s detergentními vlastnostmi, které napomáhají solubilizaci tuků v trávicím traktu.

Fekální biomarkery

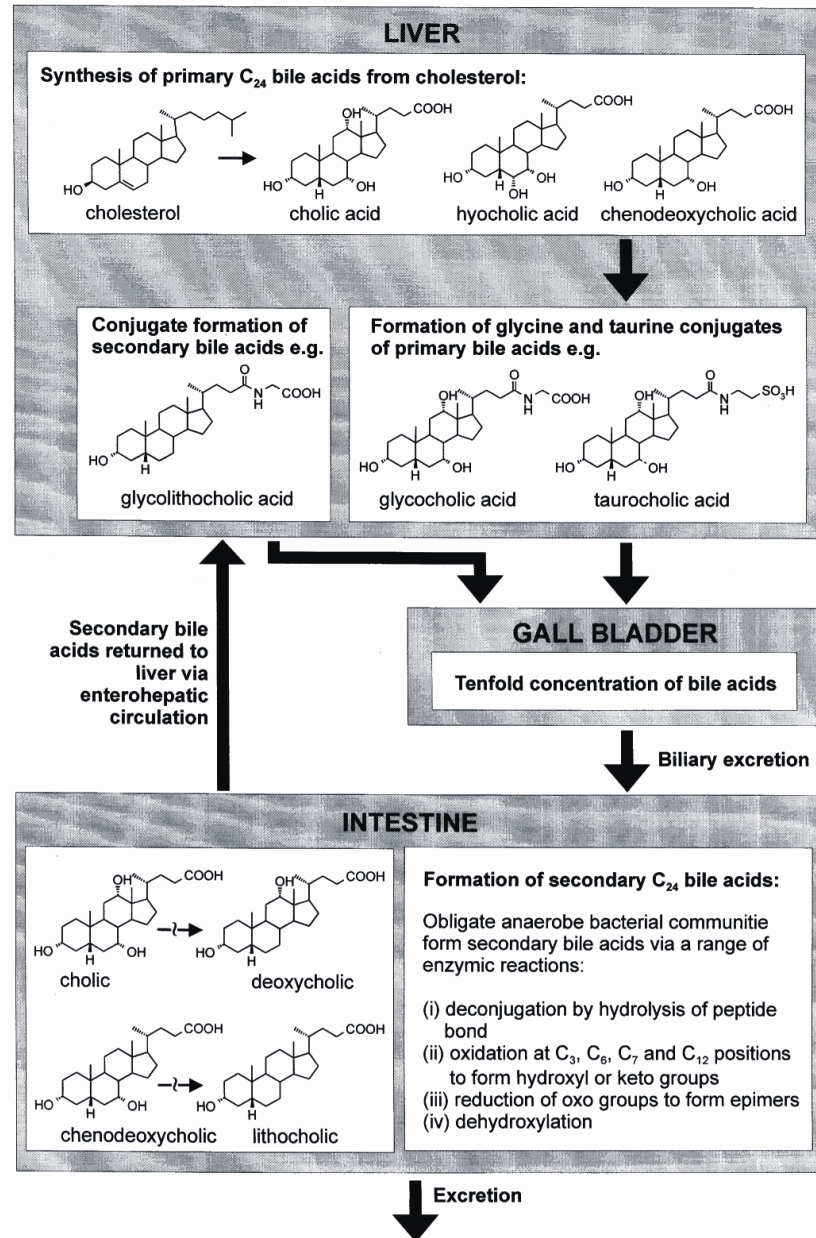


Fig. 2. An overview of the origin of primary bile acids and their conversion, after excretion from the gall bladder, to secondary bile acids in the intestine.

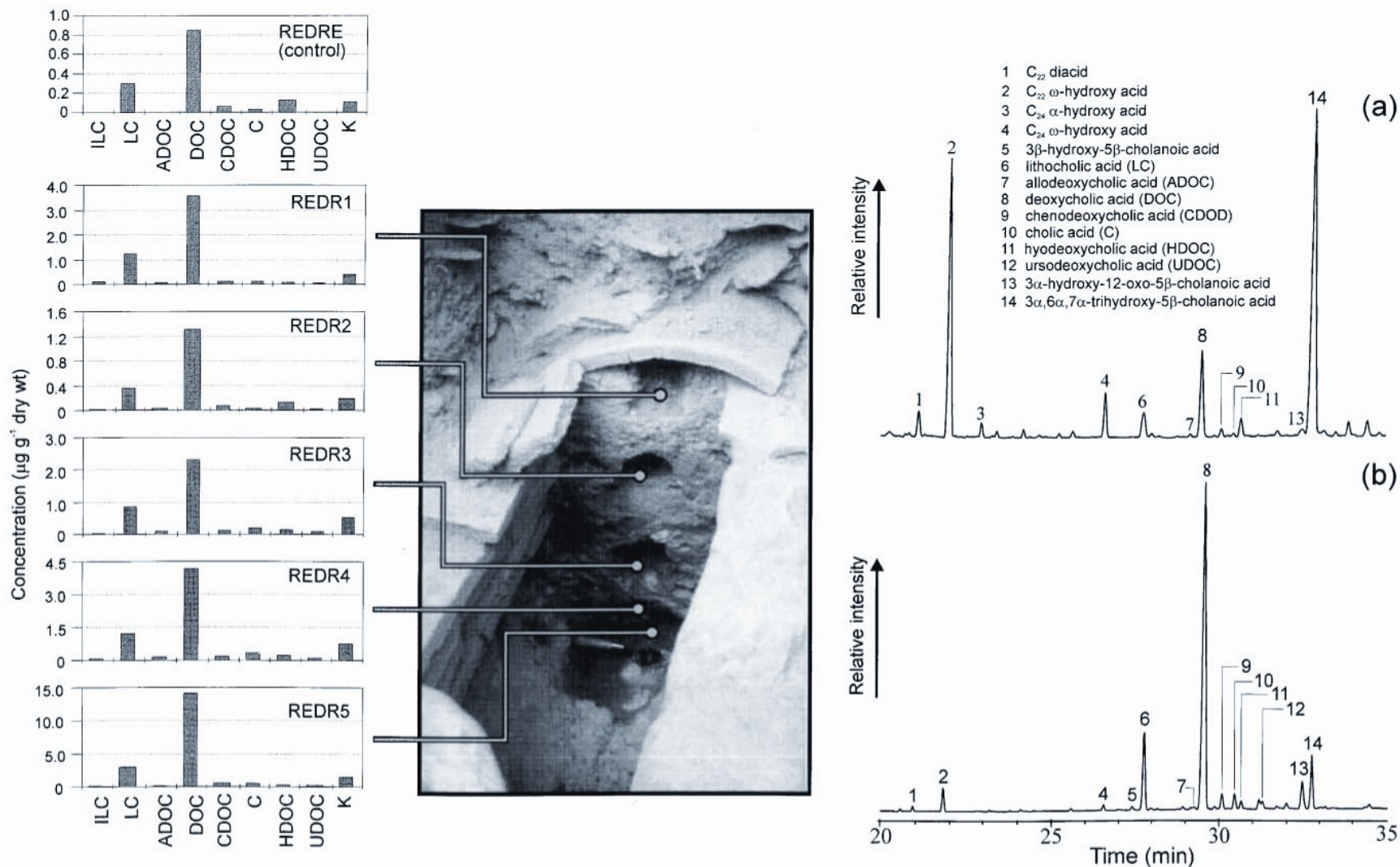
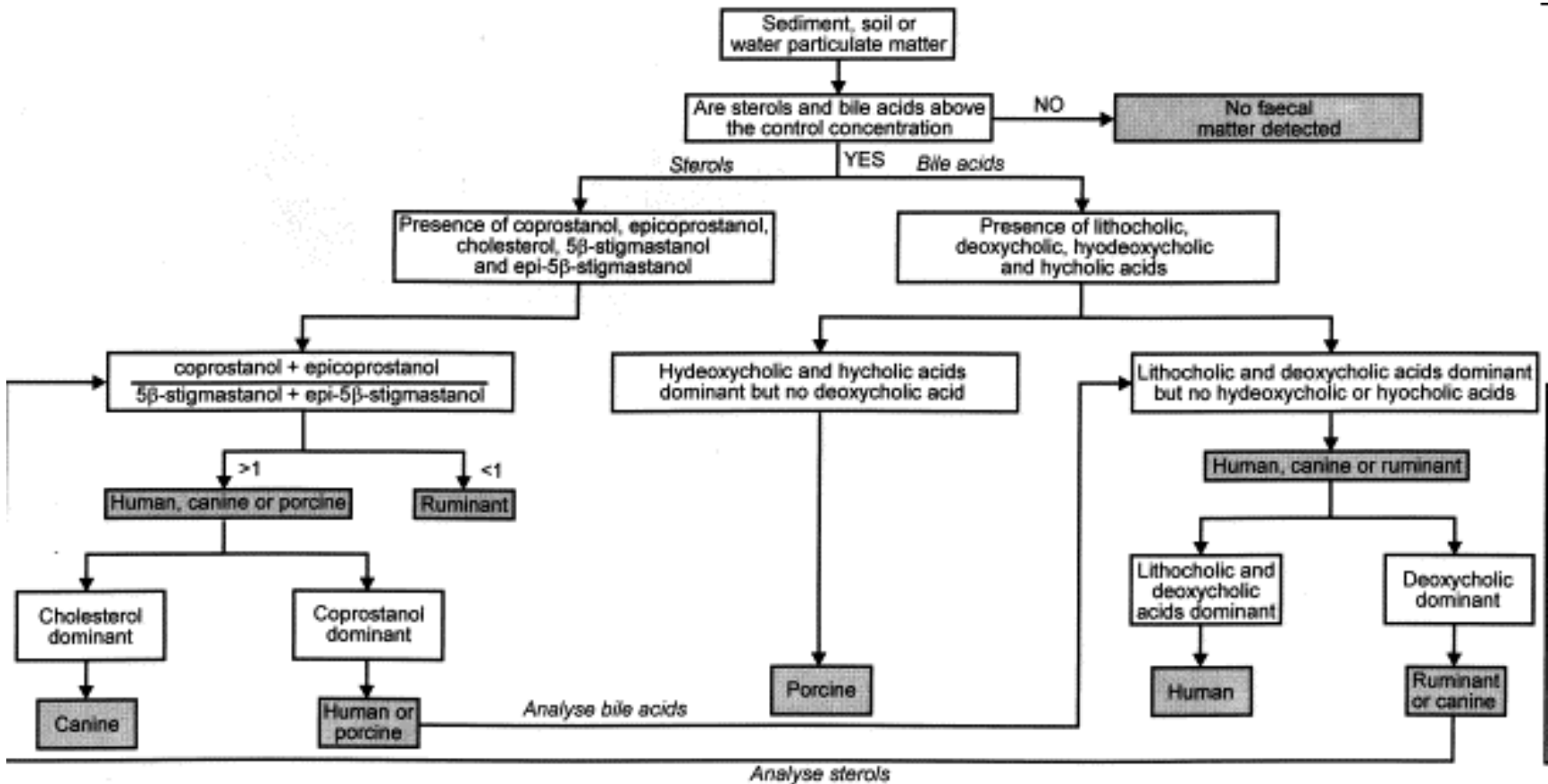


Fig. 3. Analyses of bile acids from a Roman drainage culvert excavated in Agora, Athens. Gas chromatograms of the bile acid profiles for the east control sample and sediment at the bottom of the culvert (REDR5) are displayed in (a) and (b), respectively. (c) Depicts histograms for the control (REDRE), and samples taken progressively deeper down the sides of the drain (REDR1-4) and the sediment (REDR5) in the bottom of the drain (see inset photograph).

Fekální biomarkery



Mikrobiální transformace cholesterolu



Lindow man

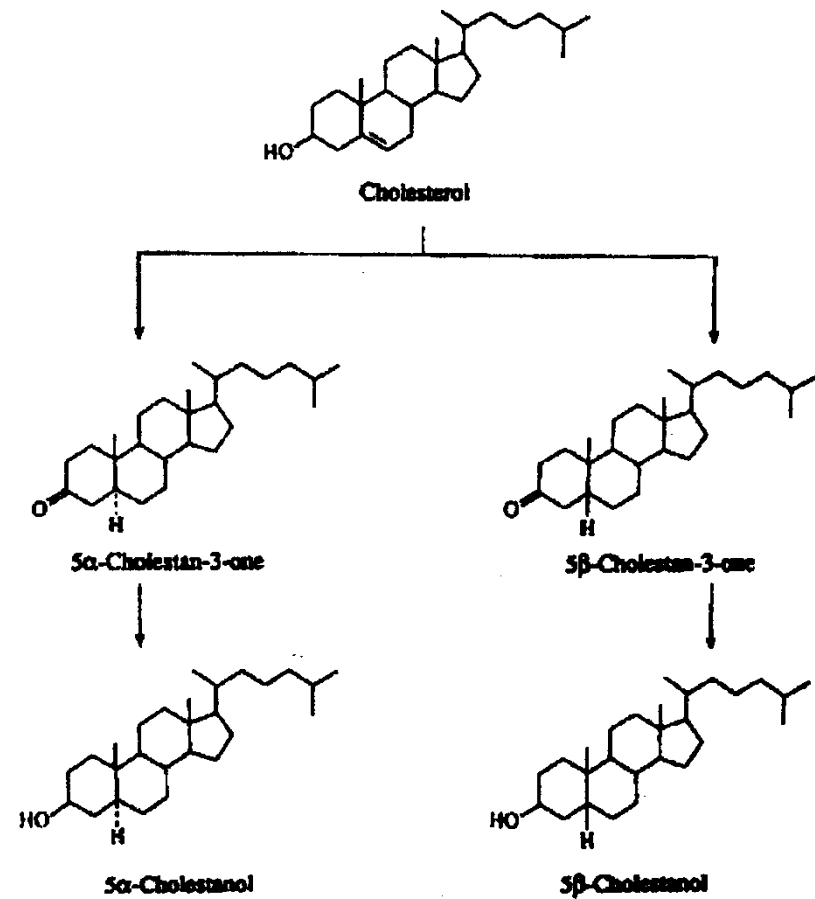


Figure 2. Biochemical relationship between the endogenous cholesterol and the steroidal degradation products found in the body tissues of Lindow Man.

Mikrobiální transformace cholesterolu

Muž z Lindow (rašeliniště u Cheshire), doba železná

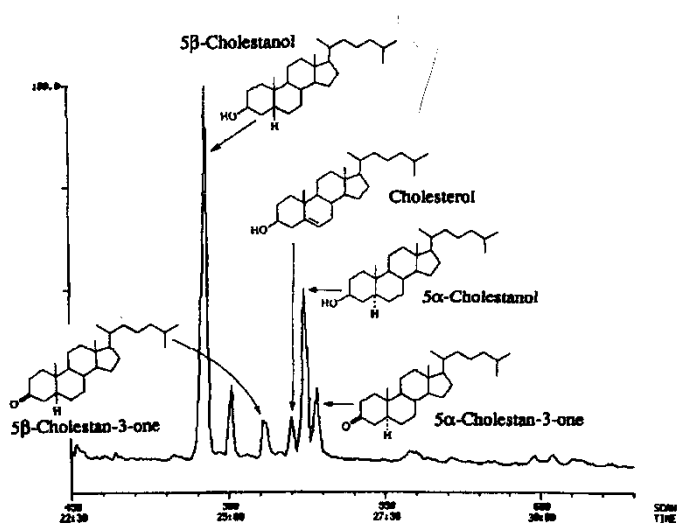


Figure 3. Partial GC/MS total ion chromatogram showing the steroidal components of the neutral fraction of the total lipid extract of a sample of skin tissue from Lindow Man. See text for full experimental details.

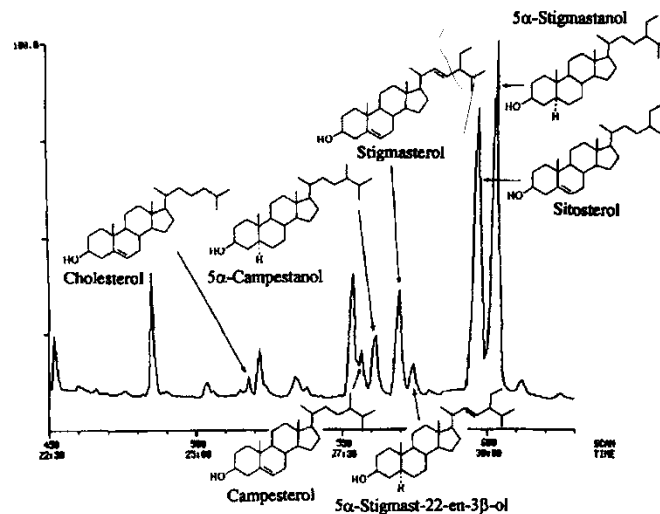


Figure 4. Partial GC/MS total ion chromatogram showing the stanol and stanol components isolated by TLC from the total lipid extract of Lindow peat. See text for full experimental details.

Anaerobní podmínky

cholesterol \rightarrow 5α - resp. 5β -cholestan-3-on \rightarrow 5α - resp. 5β -cholestanol (koprostanol)
působením mikroorganismů

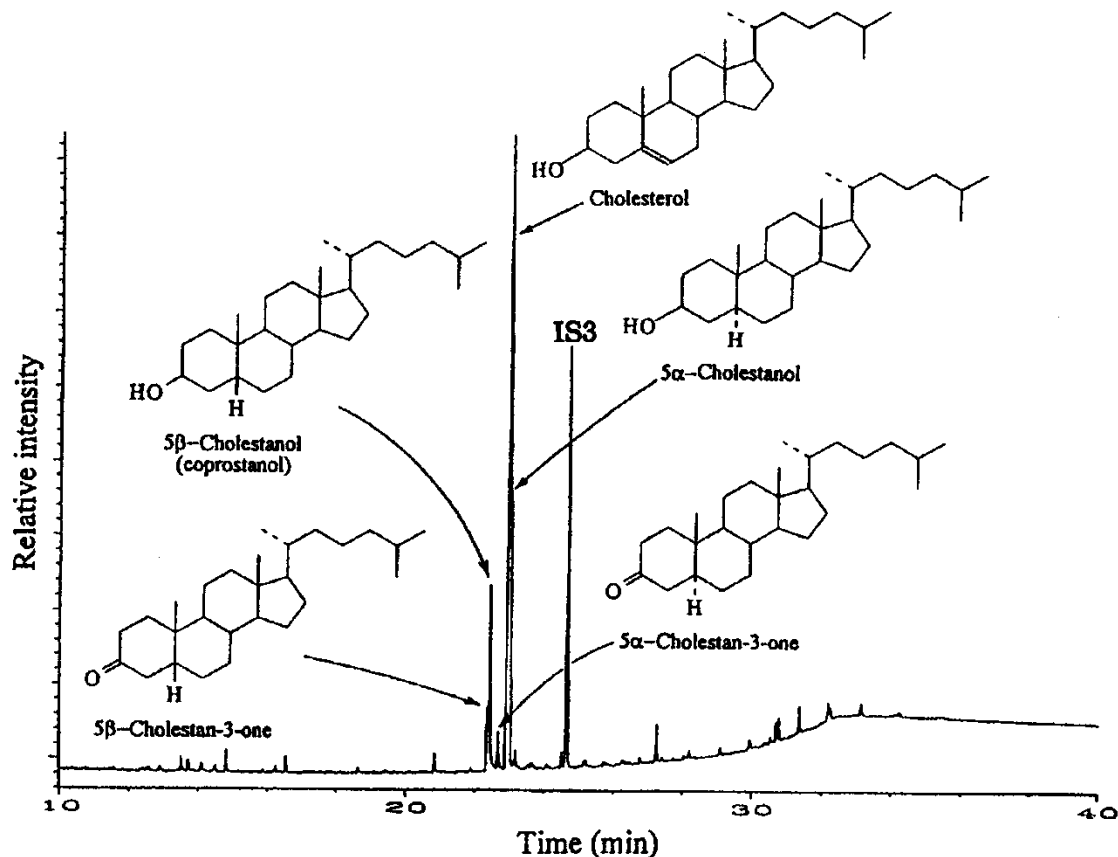


Figure 3. Partial gas chromatogram of the trimethylsilylated total lipid extract of the horse metapodial bone from the Roman excavation at Ribchester, U.K.

Aerobní podmínky

cholesterol → cholest-5-en-3 β -ol-7-on

autooxidace zahrnující atak singletovým kyslíkem vedoucí na keto- a hydroxy-deriváty přes hydroperoxydy nebo oxidace katalyzovaná lipoxygenázou (rozklad tkání, mikrobiální)

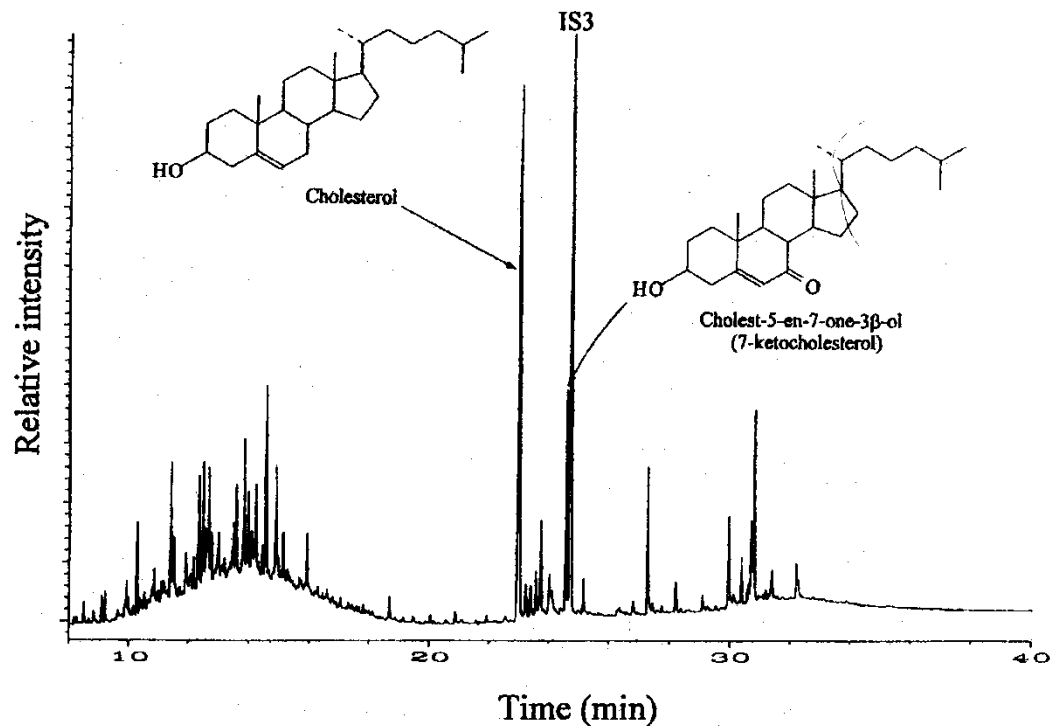
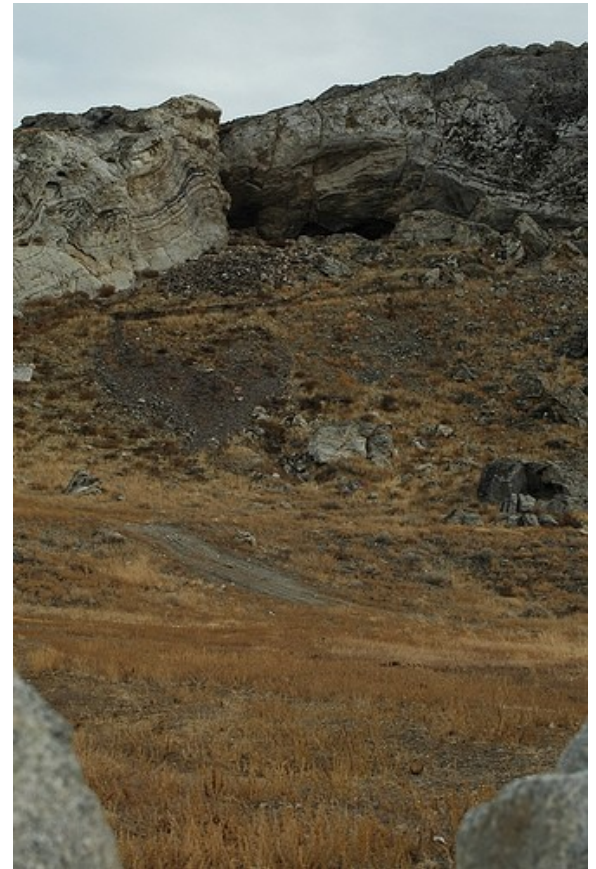
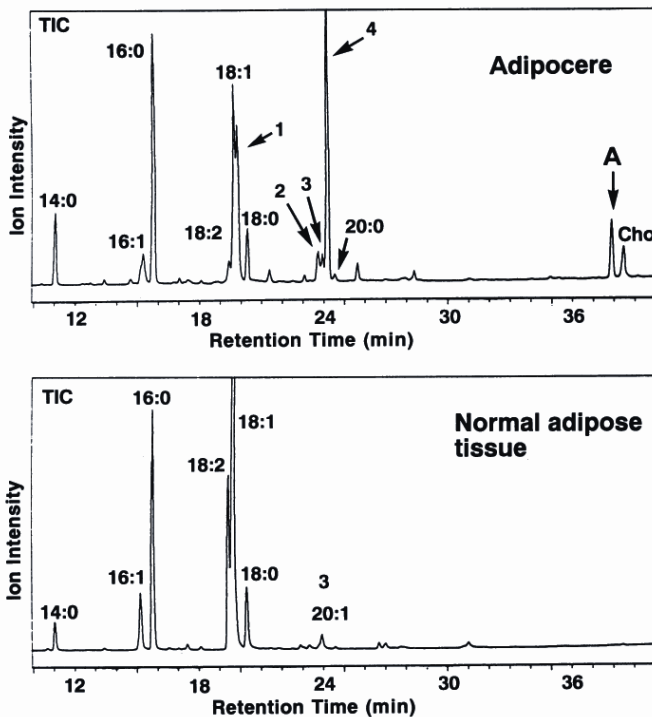


Figure 4. Partial gas chromatogram for the total lipid extract of a 4th–6th century bone (human tibia).

Epimerace 3 β stanolu

Epimerace 3 β stanolu (koprostanol) na 3 α (epikoprostanol) v koprolitech nevadských Indiánů (cca 50 n. l.); 3 α se v čerstvé stolici nevyskytuje, jeho vznik je spontánní (konverzí přes keton), protože je termodynamicky stabilnější než koprostanol.



Epikoprostanol byl prokázán i v adipociru (působení mikroorganismů?)

FIG. 1. Total ion chromatograms (TIC) for adipocere and normal adipose tissue (control). 1, 10-Hydroxyhexadecanoic acid (10-OH 16:0); 2, 10-ketooctadecanoic acid (10-keto 18:0); 3, eicosenoic acid (20:1); 4, 10-hydroxyoctadecanoic acid (10-OH 18:0); A, epicoprostanol; Cho, cholesterol.

Vosky

Směs alkanů s dlouhým lineárním řetězcem a esterů vyšších MK s alkoholy s dlouhým lineárním řetězcem („voskové estery“) s nižším podílem volných alkoholů a MK.

Látky „voskovité“ konzistence (parafinový vosk, stearinový vosk)

wax components

Compound	General structure
n-Alkanes	$\text{H}_3\text{C}[\text{CH}_2]_n\text{CH}_3$
Ketones	R^1COR^2
Secondary alcohols	$\text{R}^1\text{CH}(\text{OH})\text{R}^2$
β -Diketones	$\text{R}^1\text{COCH}_2\text{COR}^2$
Monoesters	R^1COOR^2
Primary alcohols	RCH_2OH
Aldehydes	RCHO
Alkanoic acids	RCOOH
Dicarboxylic acids	$\text{HOOC}[\text{CH}_2]_n\text{COOH}$
ω -Hydroxy acids	$\text{HOCH}_2[\text{CH}_2]_n\text{COOH}$

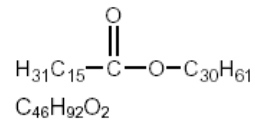
Vosky

Category of Wax	Source	Melting Point
Animal and Insect Waxes		
Beeswax	Bees/Honeycombs	62-65 C
Spermaceti	Skull of the Sperm Whale	42-50 C
Wool Grease and Lanolin	Sheep/Wool	36-42 C
Vegetable Waxes		
Carnauba	Leaves/ Brazilian palms (<i>Copernicia cerifolia</i>)	78-85 C
Candelilla Wax	Whole plants/ Mexican (<i>Euphorbia antisiphilitica</i> , <i>Euphorbia cerifera</i> , <i>Pedilanthus pavones</i>)	67-79 C
Jajoba Oil	Green nuts of bush (<i>Simmondsia californica</i>)	6.8-7.0 C
Mineral Waxes		
Montan Wax	lignite or brown coal	80 C
Petrolatum	Paraffin	63.3 C
Microcrystalline Slack Wax	Paraffin	48.5 C
Microcrystalline Petrolatum	Paraffin	57.9 C
Synthetic Waxes		
Polyethylenes	ethylene	97-106 C
Fischer-Tropsch	hydrogen + carbon monoxide synthesis	105-108 C
Ester Waxes	oxidization of Fischer-Tropsch waxes	98-104 C
Synthetic Esters e.g. Cetyl stearate	Long-chain fatty acids + fatty alcohols synthesis	Various

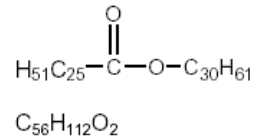
Včelí vosk

= sekret včely medonosné (*Apis mellifera*), materiál se získává přetavením plástů v horké vodě. Je tvořen zejména voskovými estery (72 %), zejm. myricylpalmitátem ($C_{15}H_{31}COOC_{30}H_{61}$), volné MK (cca 13 %) a uhlovodíky (12 %) s počtem uhlíků C_{25} - C_{31} .

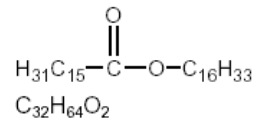
Bt 62-65 C



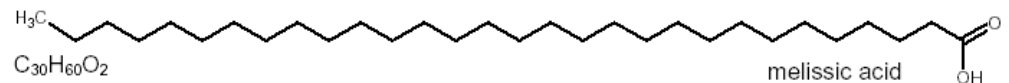
palmitic acid ester of myricyl alcohol



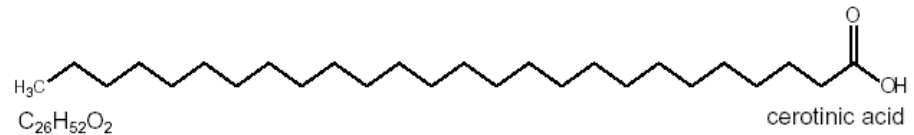
hexaeicosan acid ester of myricyl alcohol



palmitic acid ester of cetyl alcohol



melissic acid



cerotinic acid



Tel Rehov, S Izrael;
cca 900 B.C.

30 intaktních úlů, včetně
pozůstatků pláství a vosku

Dosud nejstarší známé intaktní
úly.



Včelí vosk

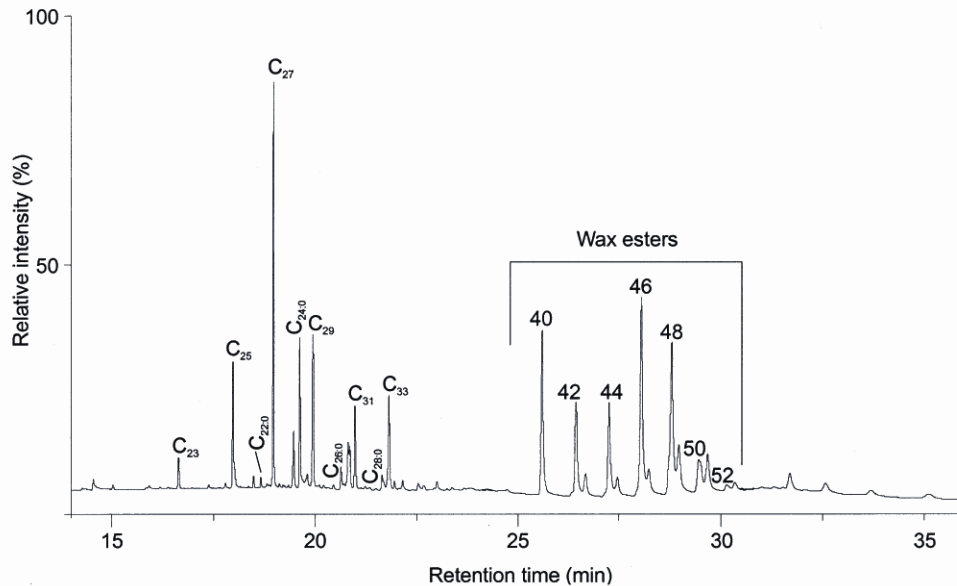


Figure 4 A characteristic gas chromatogram of contemporary trimethylsilylated contemporary beeswax (from the Doubs, France). C_x corresponds to the *n*-alkanes containing *x* carbon atoms; $C_{y:0}$ corresponds to free fatty acids with *y* carbon atoms.

estery kyseliny palmitová, palmitolejové, hydroxypalmitové a olejové s alkoholy s dlouhým lineárním řetězcem (C30-32) (cca 70 - 80%).

poměr triacontanylpalmitátu (nebo melissylpalmitátu, C30 alkohol esterifikovaný C16 MK) k cerotové kyselině (C26:0), další hlavní složce vosku, je 6:1.

aliphatické uhlovodíky (10 - 18 % heptacosanu a nonacosanu a ostatních uhlovodíků s C 17 - to 35), nenasycené uhlovodíky (C 21 - to 35) s 1 – 2 dvojnými vazbami,

steroly (přes 2% cholesterolu, lanosterolu, b-sitosterolu),

Včelí vosk

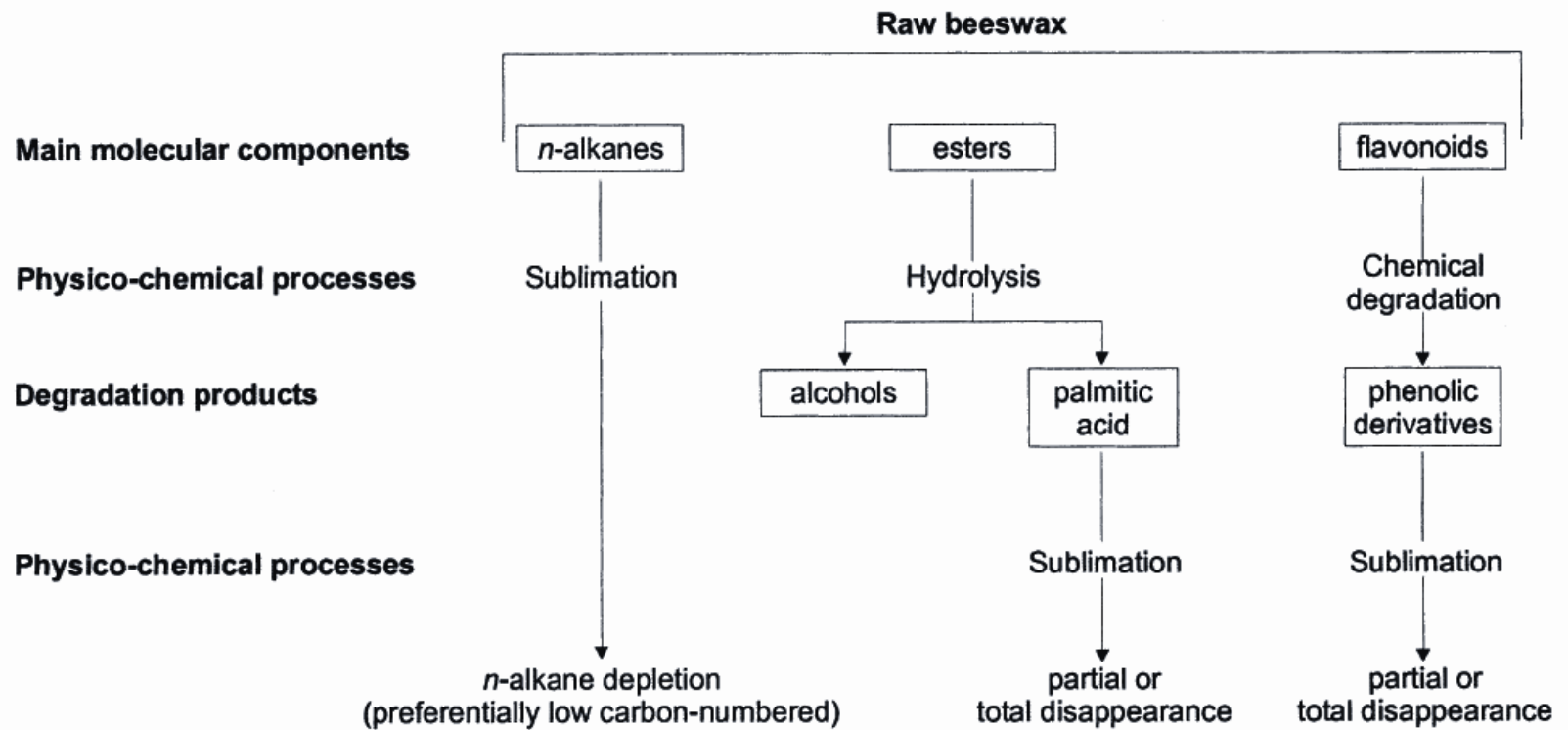
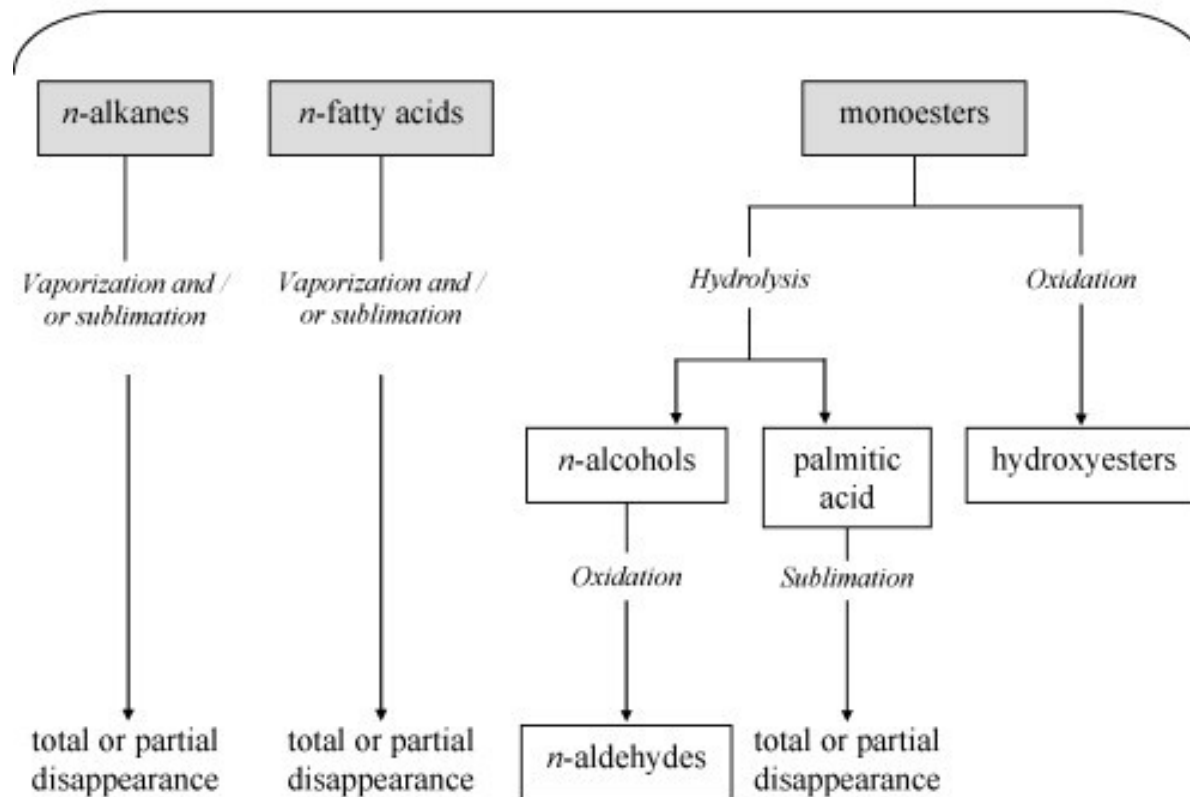


Figure 8 A summary of the physico-chemical mechanisms involved in beeswax degradation.

Včelí vosk

Main molecular compounds of modern beeswax



Aplikace

adhezivum, hydrofobizační materiál

pojivo malby

modelovací materiál (voskové figury)

ochrana povrchů, konzervace

svíčky (voskovice).

odlévání bronzu („ztracená forma“)

mumifikace

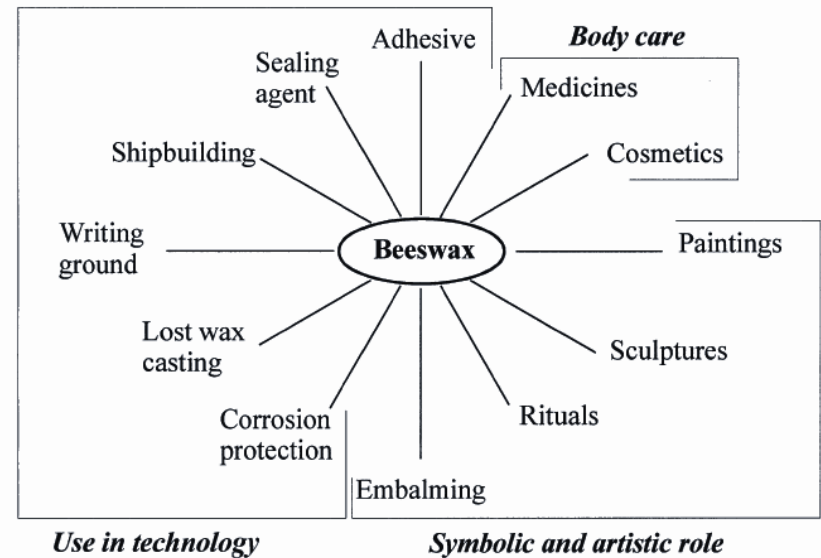
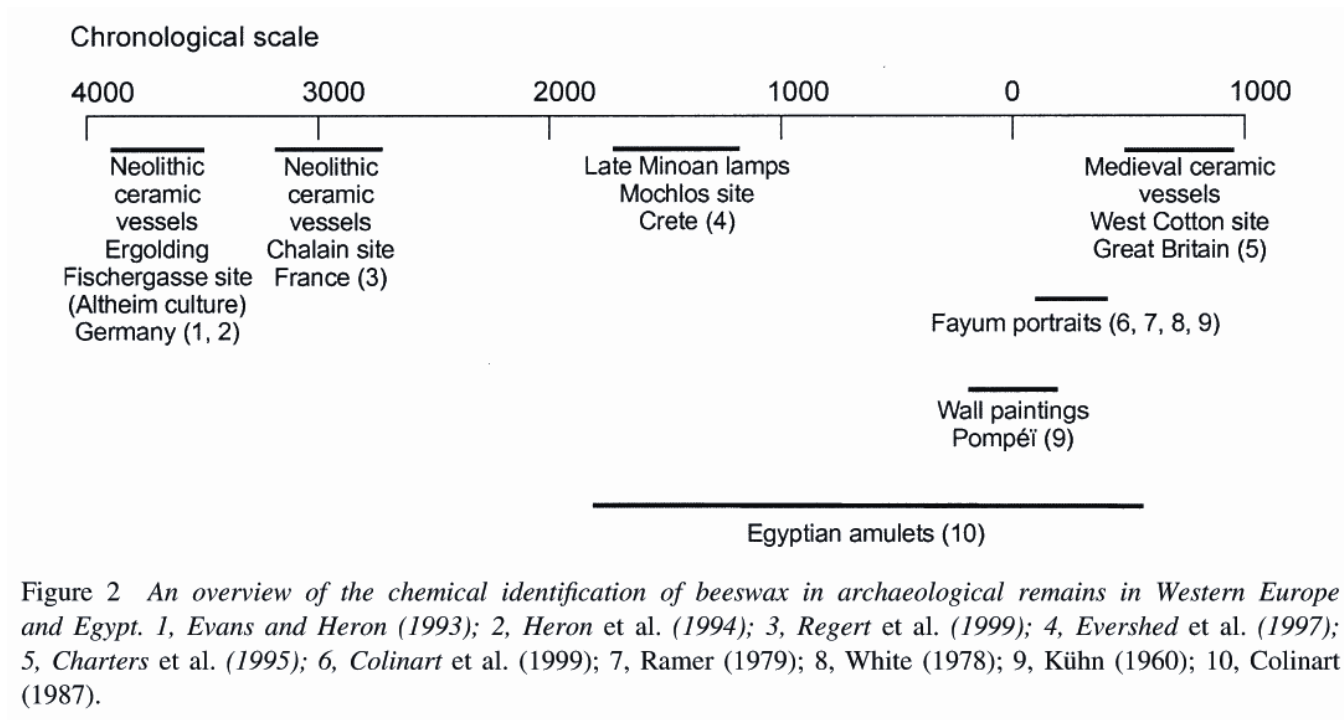


Figure 1 The different functions of beeswax during Antiquity.

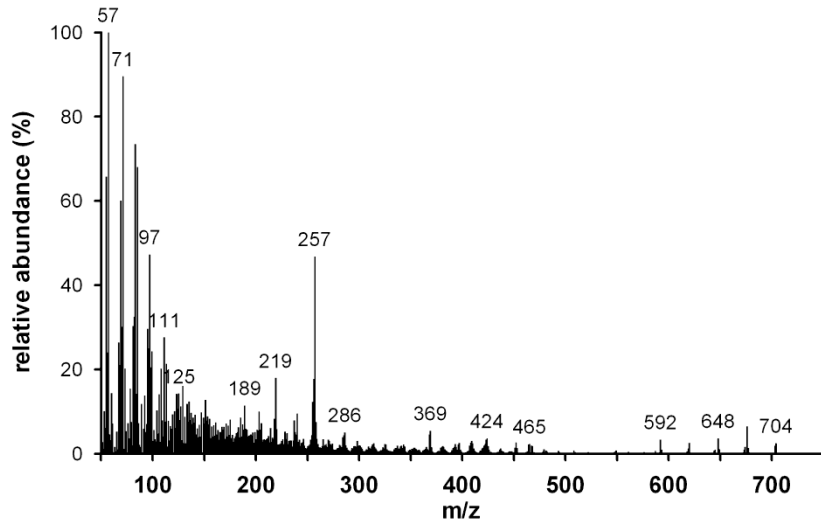
Aplikace



Vosk

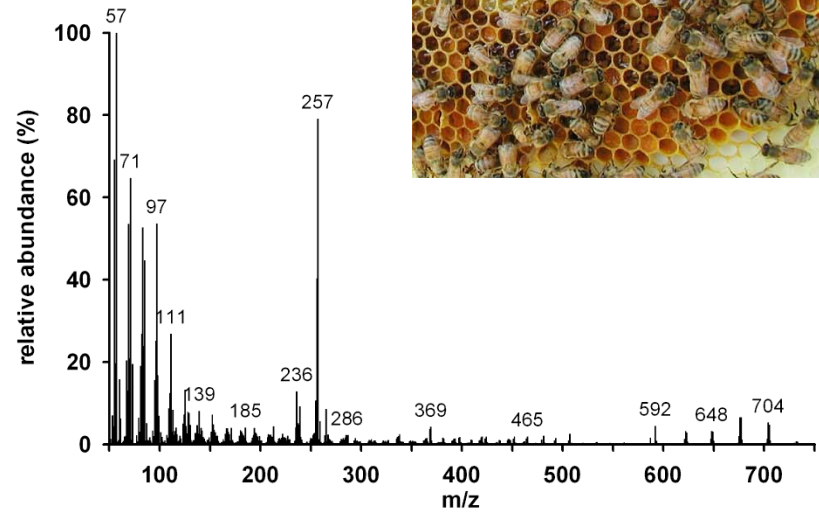


1 cm



Dolní Sukolom

Silicový nožík s nánosem organické hmoty (pozdní eneolit).



Hmotnostní spektrum (DIP-MS) vzorku organické hmoty z Dolní Sukolom (A) a recentního vosku (B) pro energii ionizace 70 eV.

Fountains

(Velká Británie)

Cisterciácké opatství

12. Století

Zbytky svíček a organické
zbytky na svícnech získané při
vykopávkách

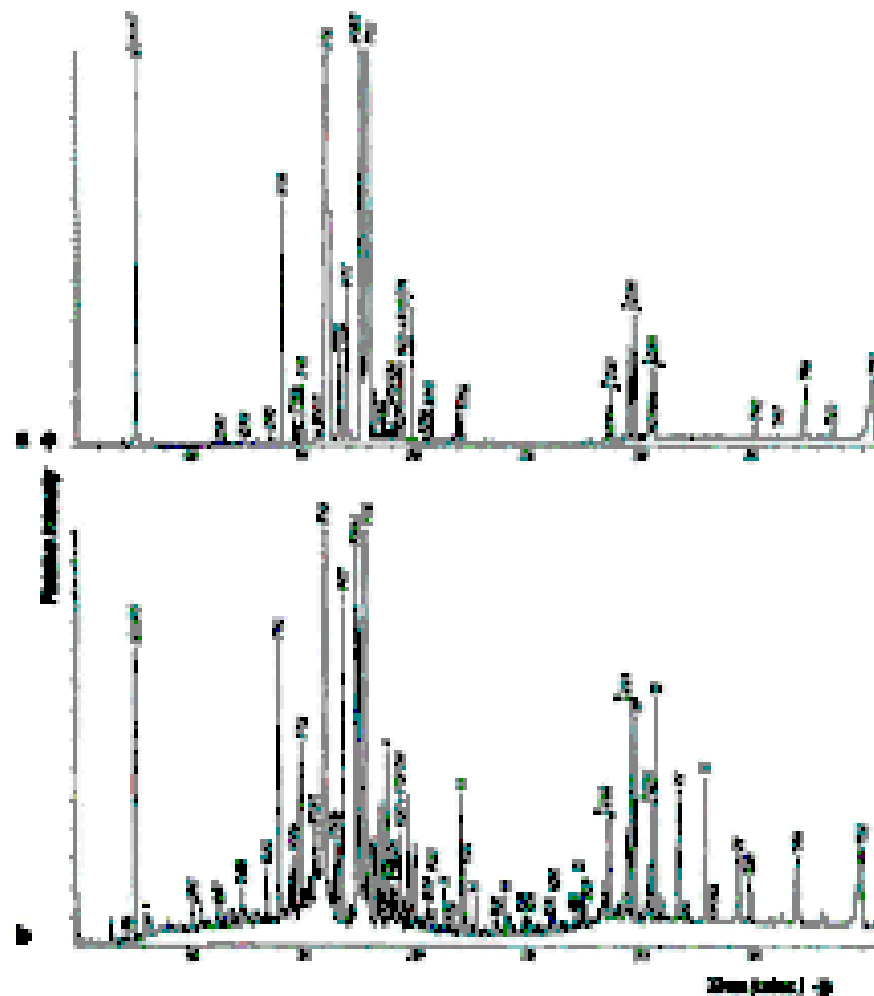


FIG. 4
 Gas chromatograms showing the results from samples 85, 93 (a) and 93, 102 (b). All peaks are identified
 over the whole range from 10 to 100 minutes and carbon numbers. Peak identities were established by GC-MS. (a) Data —
 Decarboxylated acid with a carbon atom; C17 — Saturated fatty acid with a carbon atom; C18 — Decarboxylated
 fatty acid with a carbon atom; C19 — Mono-substituted fatty acid with a carbon atom; C20 —
 Hydroxy fatty acid with a carbon atom; C21 — Mono-substituted fatty acid with a fatty acyl carbon atom; C22 —
 Diacylfatty acid with a fatty acyl carbon; C23 — Diacylfatty acid with a fatty acyl carbon atom. Note that the
 diacylfatty acids correlate to C23 (not shown), C27, C31Ac — Diacylfatty acid with a carbon atom; C24 —
 Saturated fatty acid with a carbon atom; C25 — Saturated fatty acid with a carbon atom; C26 —
 Mono-substituted fatty acid with a carbon atom; C27 — Hydroxy fatty acid with a carbon atom; C28 —
 Mono-substituted fatty acid with a fatty acyl carbon atom; C29 — Saturated fatty acid with a carbon atom; C30 —
 Diacylfatty acid with a fatty acyl carbon atom; C31 — Saturated fatty acid with a carbon atom; C32 —
 Diacylfatty acid with a fatty acyl carbon atom; C33 — Saturated fatty acid with a carbon atom; C34 — Saturated fatty acid with a carbon atom; C35 — Saturated fatty acid with a carbon atom; C36 — Saturated fatty acid with a carbon atom; C37 — Saturated fatty acid with a carbon atom; C38 — Saturated fatty acid with a carbon atom; C39 — Saturated fatty acid with a carbon atom; C40 — Saturated fatty acid with a carbon atom; C41 — Saturated fatty acid with a carbon atom; C42 — Saturated fatty acid with a carbon atom; C43 — Saturated fatty acid with a carbon atom; C44 — Saturated fatty acid with a carbon atom; C45 — Saturated fatty acid with a carbon atom; C46 — Saturated fatty acid with a carbon atom; C47 — Saturated fatty acid with a carbon atom; C48 — Saturated fatty acid with a carbon atom; C49 — Saturated fatty acid with a carbon atom; C50 — Saturated fatty acid with a carbon atom; C51 — Saturated fatty acid with a carbon atom; C52 — Saturated fatty acid with a carbon atom; C53 — Saturated fatty acid with a carbon atom; C54 — Saturated fatty acid with a carbon atom; C55 — Saturated fatty acid with a carbon atom; C56 — Saturated fatty acid with a carbon atom; C57 — Saturated fatty acid with a carbon atom; C58 — Saturated fatty acid with a carbon atom; C59 — Saturated fatty acid with a carbon atom; C60 — Saturated fatty acid with a carbon atom; C61 — Saturated fatty acid with a carbon atom; C62 — Saturated fatty acid with a carbon atom; C63 — Saturated fatty acid with a carbon atom; C64 — Saturated fatty acid with a carbon atom; C65 — Saturated fatty acid with a carbon atom; C66 — Saturated fatty acid with a carbon atom; C67 — Saturated fatty acid with a carbon atom; C68 — Saturated fatty acid with a carbon atom; C69 — Saturated fatty acid with a carbon atom; C70 — Saturated fatty acid with a carbon atom; C71 — Saturated fatty acid with a carbon atom; C72 — Saturated fatty acid with a carbon atom; C73 — Saturated fatty acid with a carbon atom; C74 — Saturated fatty acid with a carbon atom; C75 — Saturated fatty acid with a carbon atom; C76 — Saturated fatty acid with a carbon atom; C77 — Saturated fatty acid with a carbon atom; C78 — Saturated fatty acid with a carbon atom; C79 — Saturated fatty acid with a carbon atom; C80 — Saturated fatty acid with a carbon atom; C81 — Saturated fatty acid with a carbon atom; C82 — Saturated fatty acid with a carbon atom; C83 — Saturated fatty acid with a carbon atom; C84 — Saturated fatty acid with a carbon atom; C85 — Saturated fatty acid with a carbon atom; C86 — Saturated fatty acid with a carbon atom; C87 — Saturated fatty acid with a carbon atom; C88 — Saturated fatty acid with a carbon atom; C89 — Saturated fatty acid with a carbon atom; C90 — Saturated fatty acid with a carbon atom. Note that the diacylfatty acids correlate to C23 (not shown).

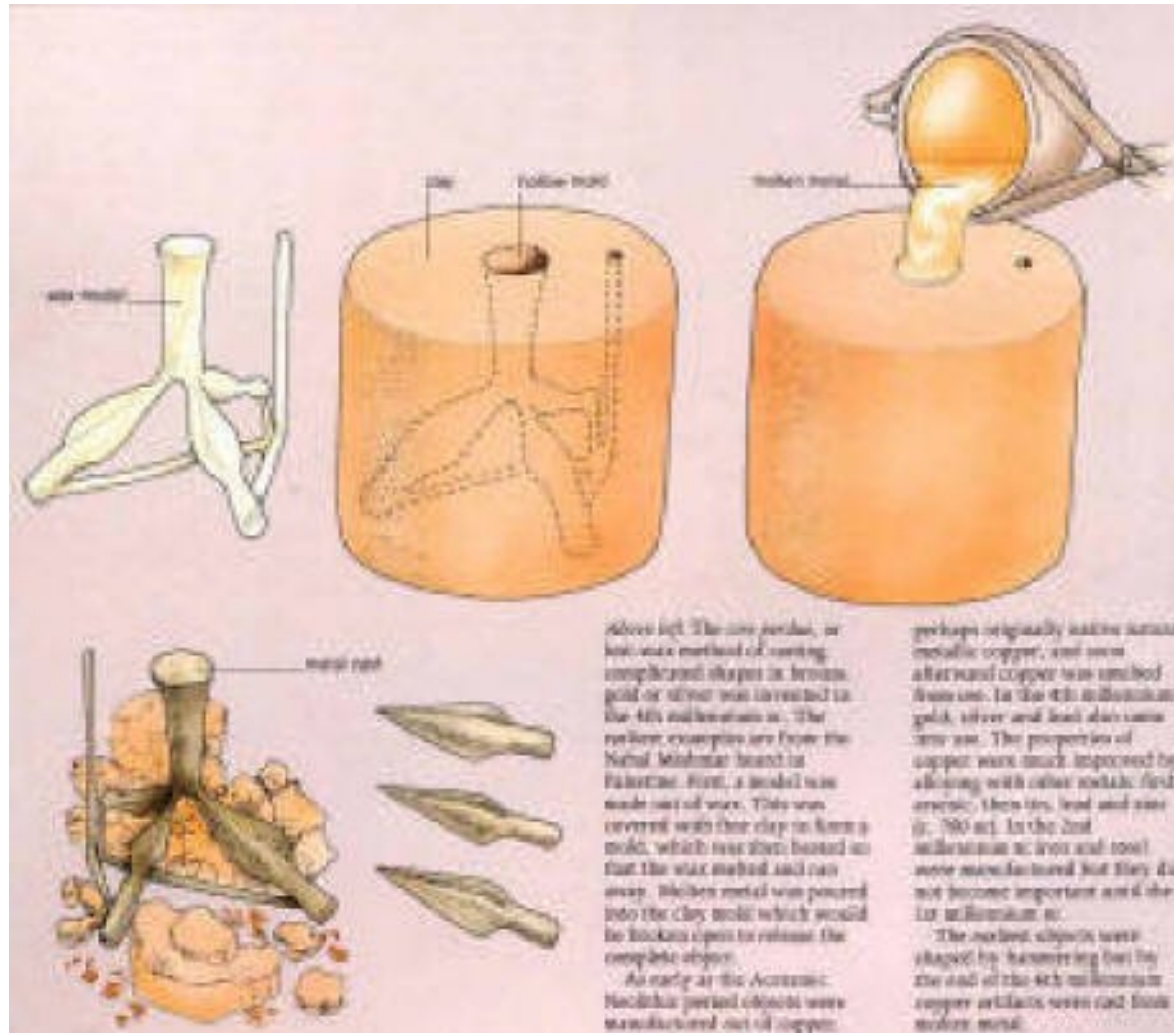
Využití vosku



Egyptská psací destička, cca 600 n.l.



Lití na „ztracenou formu“



Punský vosk

= včelí vosk částečně zmýdelněný sodou.

Plinius a Dioscorides:

vosk se vaří ve slané mořské vody a potom precedí. To se opakuje několikrát. Potom se vosk bělí na slunci a následně saponifikuje přidáním sodného bikarbonátu).

Před aplikací se přidávají další složky:

olej (většinou lněný), pro zvýšení tekutosti

vaječný žloutek zlepšuje adhezi.

Následně se přidávají pigmenty = enkaustická malba

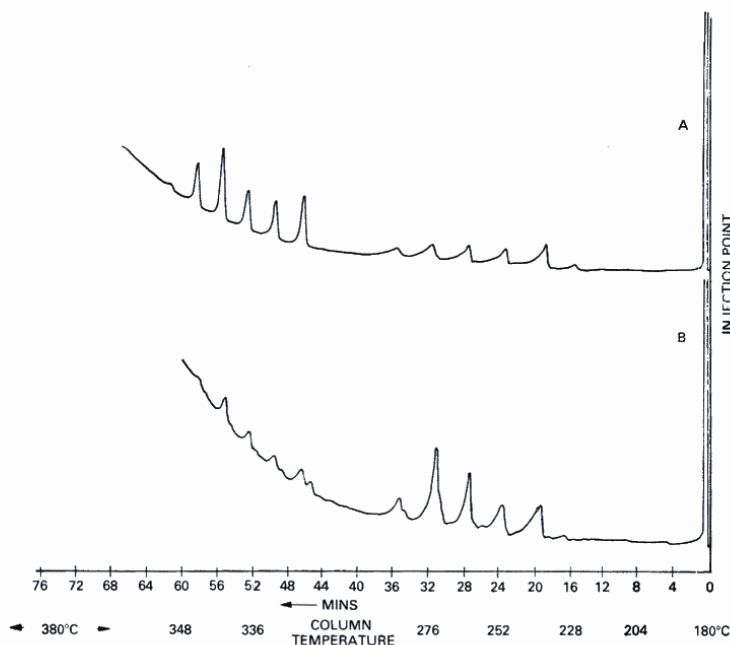


FIG. 8 Gas-chromatograms of wax medium from two Fayum portraits A. typical of simple beeswax; B. showing reduced ester peaks, suggestive of partially saponified (Punic) beeswax.

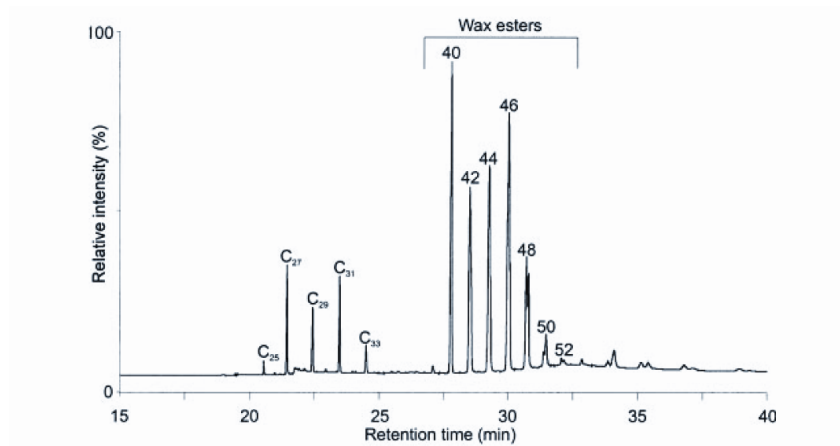


Figure 12 A gas chromatogram of the organic binder from a Fayum woman portrait (Louvre Museum, Inv. MND 2047, 2nd century AD), showing the presence of altered beeswax. C_x corresponds to *n*-alkanes with *x* carbon atoms.

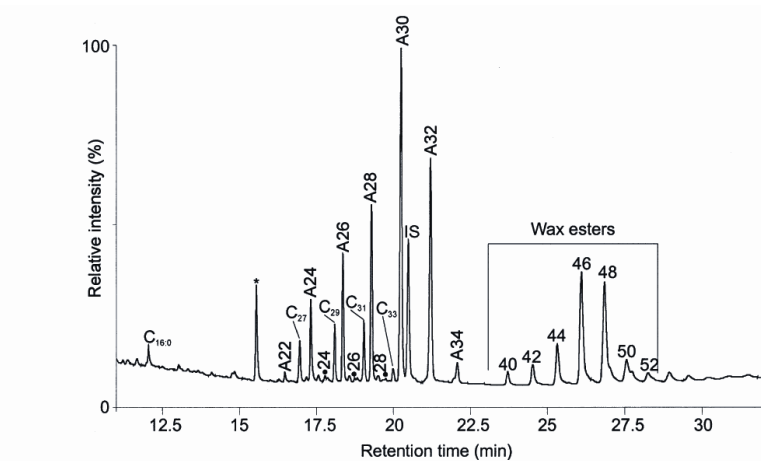


Figure 11 A gas chromatogram of the organic content of a ground trimethylsilylated sherd OD3037D1 (Sect. V/E, fouille 93, carré 313, 102, sac 31, no. 4) from Dikili Tash, showing the presence of altered beeswax. C_x corresponds to *n*-alkanes with *x* carbon atoms; A_y corresponds to linear long-chain alcohols containing *y* carbon atoms. $C_{16:0}$ is palmitic acid. The black disc with a number is, for long-chain fatty acids, the number corresponding to the carbon atom number. IS, internal standard; *, plasticizer.

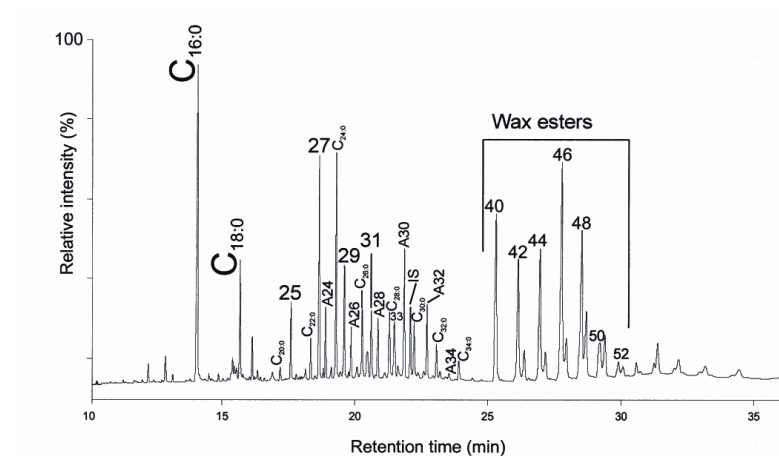


Figure 9 A gas chromatogram of the trimethylsilylated charred surface residue OD3006C1 from Bercy, showing the presence of altered beeswax. Numbers between 25 and 33 correspond to *n*-alkanes; A_x corresponds to linear long-chain alcohols containing *x* carbon atoms and $C_{y:0}$ corresponds to long-chain fatty acids with *y* carbon atoms. IS, internal standard.

Pečetní vosk

Byl používán zhruba od počátku 16 století. Byl složen z vosku a kalafuny, která činila vosk křehčím a tvrdším. Díky kalafuně materiál rychleji tuhnul a otisky v něm byly zřetelnější. V pozdějších obdobích se přidával i šelak.

Jako barvivo se přidávala rumělka nebo suřík



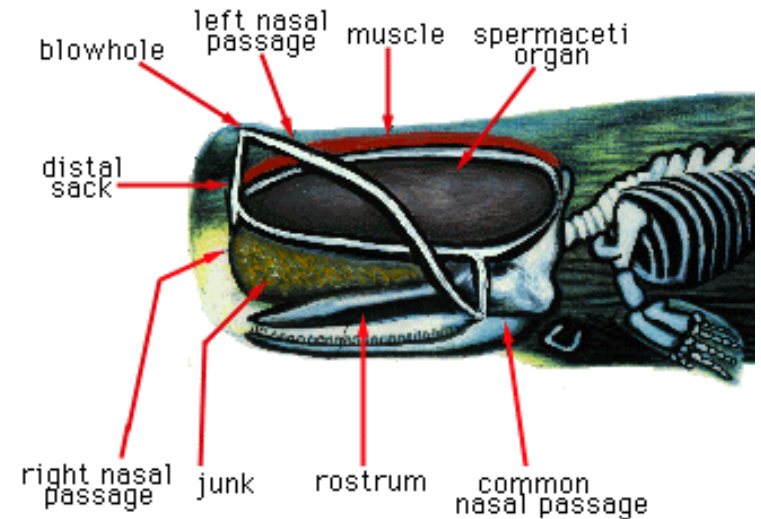
Edward Collier: Zátiší (1697)

Vorvaňovina (spermacet)

Spermacet se získává ochlazením podkožního tuku (obsah je cca 11%) a z lebeční dutiny vorvaně obrovského (*Physeter macrocephalus*). Čelní orgán, používaný jako sonar, obsahuje u 15 metrového živočicha cca 3 tuny spermacetu.



Internal Structures of Sperm Whale Head



Vorvaňovina

Spermacet obsahuje voskové estery (65-95%), triglyceridy (5-30 %), volné alkoholy (1-5 %) a kyseliny (0-3 %). Estery jsou tvořeny zejména cetyl palmitátem (C32) a cetyl myristátem (C30).

Bt. 42-50 C.

Spermacet byl od 15. století používán v medicíně (afrodiziakum) a později v kosmetice, jako mazivo a k výrobě svíček, kde se ke spermacetu přidává lůj, včelí vosk a nebo později parafin, Z této hmoty byly vyráběny svíčky mimořádné kvality, které se vyznačovaly stejnoměrným jasným plamenem a naprostou absencí jakéhokoliv zápachu.

Další aplikace: konzervace usně a pergamenu

Lanolin

Je produkován mazovými žlázami ovcí, z vlny se izoluje vymýváním alkáliemi nebo detergenty. Surová vln obsahuje cca 10-24 % tuku. Lanolin se získává jeho rafinací.

Lanolin obsahuje estery MK (14-24 %), sterolů a esterů triterpenoidních alkoholů (45-65 %), volné alkoholy (6-20 %), steroly (cholesterol, lanosterol) a terpeny (4-5 %), hydroxylované MK (zejm. hydroxypalmitová) volné nebo esterifikované. Řetězce MK s 14 - 35 uhlíky, některé s rozvětvenými řetězci (iso- nebo anteiso- konformace).

Bt 35-42 C.

Konzervace železa a usní, kosmetika, příprava barev.



Čínský vosk

Je vylučován hmyzem *Ceroplastes ceriferus* (*Coccus ceriferus*) a ukládá se na větvičkách stromů (k produkci 1g čínského vosku je zapotřebí 1500 jedinců). Hmyz se pěstuje v Číně.

Hlavní složku tvoří voskové estery (cca 83 %), obsahuje také volné kyseliny, alkoholy (nad 1 %) a uhlovodíky (2 – 3 %). Estery jsou tvořeny hlavně alkoholy a kyseliny s 26 nebo 28 uhlíky.

Přečištěný vosk se používá k výrobě svíček a úpravám povrchu.

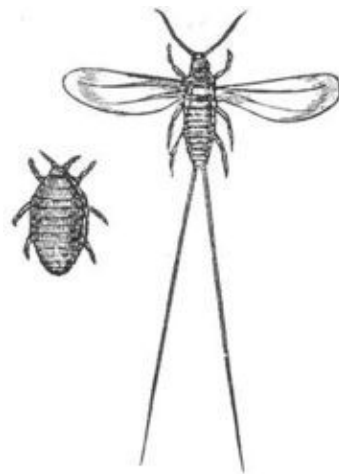


Šelakový vosk

Tento vosk (známý také jako lakový vosk) je produkován hmyzem *Tachardia lacca* (*Kerria lacca*, *Coccus lacca*, *Laccifer lacca*) žijícím v Indii. Získává se z šelakové pryskyřice, jeho vlastnosti jsou podobné karnaubskému vosku.

Obsahuje hlavně voskové estery (70-82%), volné alkoholy (8-14%), kyseliny (1-4%) a uhlovodíky (1-6%).

Je používán v nábytkářství.



Epikutikulární vosk - Brassicaea

Biomarker v archeologii: důkaz vaření kapusty (Brassica oleracea)

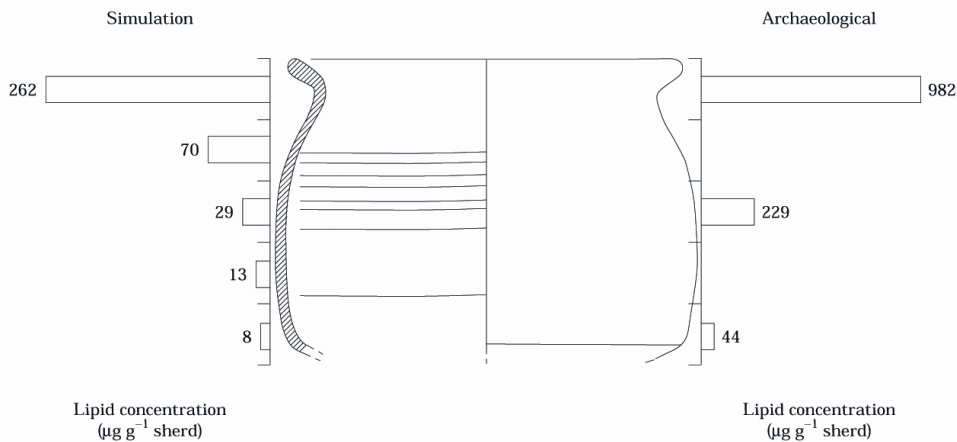


Figure 3. Diagram of a Late Saxon/early mediaeval jar (RP54). On the left is a histogram showing the lipid concentrations ($\mu\text{g lipid g}^{-1}$ sherd) as an average of three samples taken from cleaned ceramic at five points on the experimental vessel. On the right is a histogram showing the lipid concentrations ($\mu\text{g lipid g}^{-1}$ sherd) at three points on the ancient vessel (RP54).

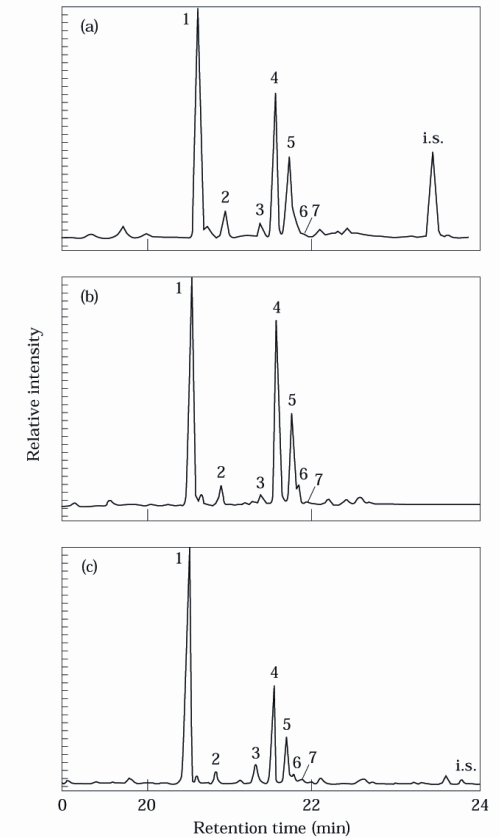


Figure 2. Partial gas chromatograms of the lipid extracts from (a) the experimental jar (ED1); (b) modern *Brassica* leaves; and (c) the ancient jar (RP54). In each case the peaks represent *Brassica* leaf wax components: 1 = *n*-nonacosane; 2 = *n*-hexacosanol; 3 = *n*-heptacosanol; 4 = nonacosan-15-one; 5 = nonacosan-15-ol; 6 = *n*-hentriacontane; and 7 = *n*-octacosanol. i.s. = the internal standard *n*-tetraatriacontane. Internal standard was not added to the leaf wax extract (b).

Espartový vosk

Získává se z trav *Lygeum spartum* a *Stipa tenacissima*, rostoucích na území jižního Španělska a severní Afriky. V současnosti se získává jako vedlejší produkt výroby papíru.

Složení vosku je velmi proměnlivé, obsahuje uhlovodíky, estery (cca 60 %), alkoholy (C 28-30; cca 20%), kyseliny (15-18 %) a triterpenoidy.

Znali ho již Féničané, Řekové a Římané (těsnění lodí, enkaustická malba), nyní se používá se hlavně ke zvýšení b. t. jiných vosků.

Espartový vosk

Lygeum spartum



Stipa tenacissima



Karnaubský vosk

Je produkován listy brazilské palmy *Copernicia prunifera cerifera*, cca 100 g z jednoho stromu ročně.



Obsahuje hlavně voskové estery (80-85%), volné alkoholy (10-15%), kyseliny (3-6%) a uhlovodíky (1-3%).

Kromě toho Karnaubský vosk obsahuje esterifikované dioly s dlouhým řetězcem (cca 20%), hydroxylované MK (cca 6%) a kyselinou skořicovou (cca 10%) hydroxylovanou nebo methoxylovanou.

Je tvrdší a má vyšší b. t. než ostatní vosky (B.t. 78-85 C) a používá se hlavně ve směsi se včelím voskem k výrobě politur na nábytek, v kosmetice a k úpravám papíru.

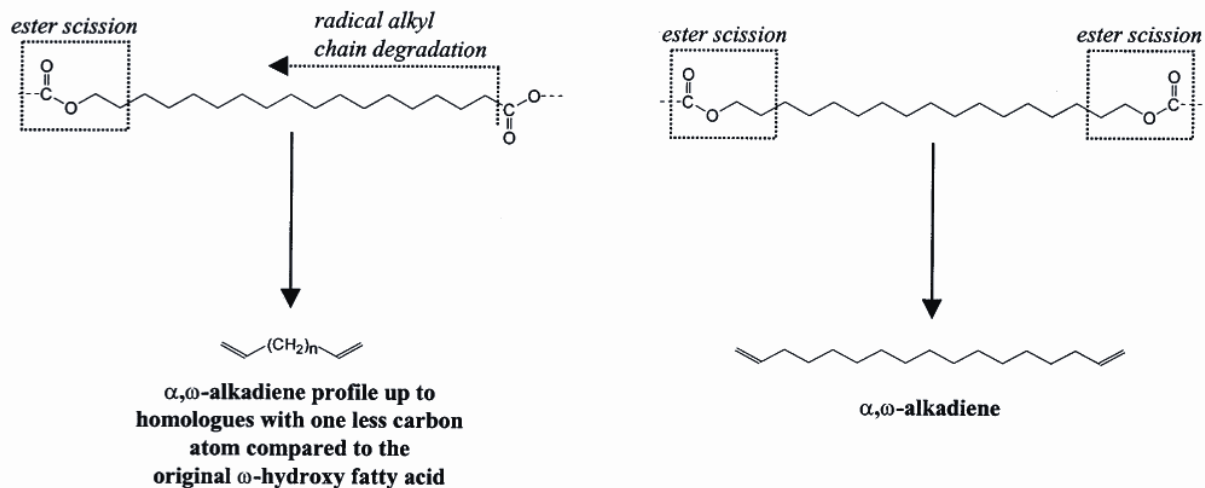


Fig. 7. Proposed thermal reaction pathways for the formation of α,ω -alkadienes in the pyrolysis of carnauba wax.

Japonský vosk

„Vosk „(rostlinný tuk) v jádrech a slupce bobulí rodů *Rhus* a *Toxicodendron*, včetně toho poskytujícího japonský lak (je vedlejším produktem při výrobě laku).

Není to pravý vosk ale tuk, obsahuje značné množství triglyceridů kyseliny palmitové (93-97%), dikarboxylové MK včetně C22 a C23 (4-5.5%) a volné alkoholy (12-1.6%).

B.t. 45-53 C.

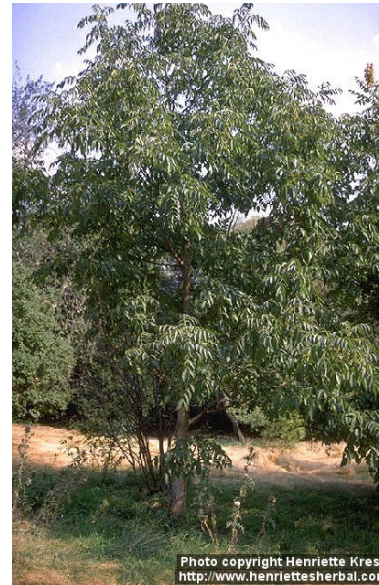
Je užíván zejména v Japonsku v kosmetice a výrobě mastí a svíček. Postupem času žlukne.



Rhus verniciflua



Toxicodendron verniciflum



Ourikuri

Byl poprvé exportován z Brazílie v roce 1937, víc se používá v současnosti.

Získává se seškrábáním z listů palmy ouricouri (*Syagrus coronata*, *Cocos coronata*).

Fyzikálními vlastnostmi se podobá karnaubskému vosku (b.t. 81-84 C), slouží jako jeho náhražka.



Jojobový olej

Používaný jako náhražka spermacetu. Získává se lisováním semen jojoby (*Simmondsia chinensis*; *Euphorbiaceae*), pěstované zejména na jihu USA a v Mexiku (Sonora), Arizona and California.

Je tvořen takřka výhradně voskovými estery (více než 98%). MK jsou 18:1n-9 (cca 10%), 20:1n-9 (cca 70%) a 22:1n-9 (15-20%), alkoholy zejména C 20 a C 22 a jednu dvojnou vazbu.

Jojobový olej je velmi odolný vůči oxidaci, používá se hlavně v kosmetice, po sulfonaci nebo hydrogenaci také jako mazivo a k výrobě svíček a k povrchovým úpravám.

Bt cca 7 C (kapalina)



Candelilla

Z mexického keře *Euphorbia cerifera* nebo *E. antisiphilitica* (*Euphorbiaceae*).

Vosk se získává vařením rostlinného materiálu (vyplouvá na hladinu).

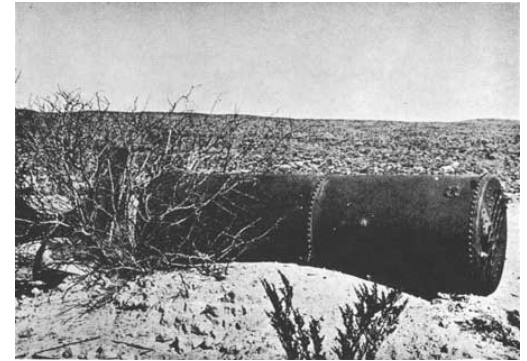
Obsahuje uhlovodíky (cca 50% C29 - C33), estery (28-29%), alkoholy, volné MK (7-9%) a pryskyřice (12-14% triterpenoidních esterů).

B.t. 67-79 C.

Přidává se do ostatních vosků (zvyšování b. t.) a používá se bv kosmetice, farmacii a potravinářství.



Candelilla



Glenn Springs
1940

Montánní vosk

Fosilizovaný rostlinný vosk, získává se extrakcí lignitu nebo hnědého uhlí (sub-bituminous coal). Začal se používat v Německu ve 2. polovině 19. století. Je to směs voskových esterů (62-68 %), mastných kyselin (22-26 %) a alkoholů, ketonů a uhlovodíků s dlouhým řetězcem (7-15 %). Montánní vosk je tvrdý a velmi odolný vůči oxidaci.

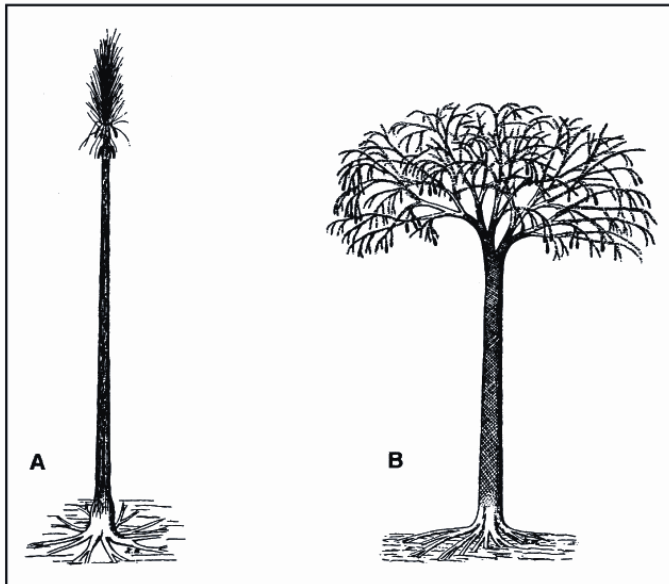


Fig. 1. Coalification of wax coated plant material in pre-historic times created deposits of montan wax. **A** Sigillaria, **B** Lepidodendron.



lignit

Mykolové kyseliny

Součást buněčných stěn mykobakterií.

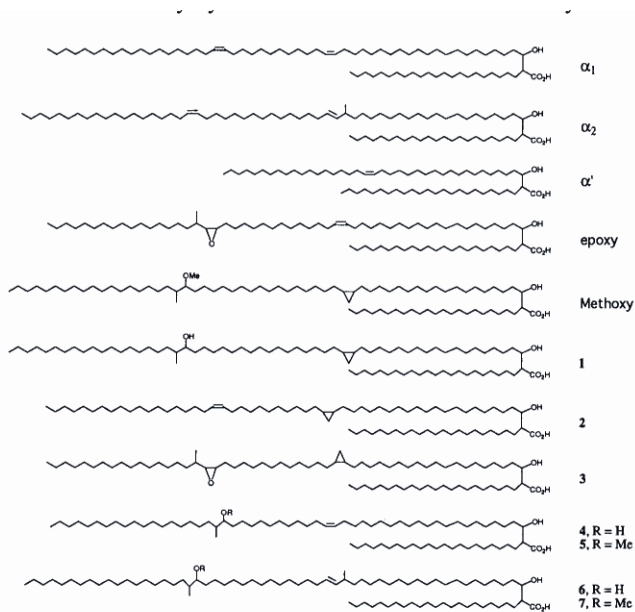
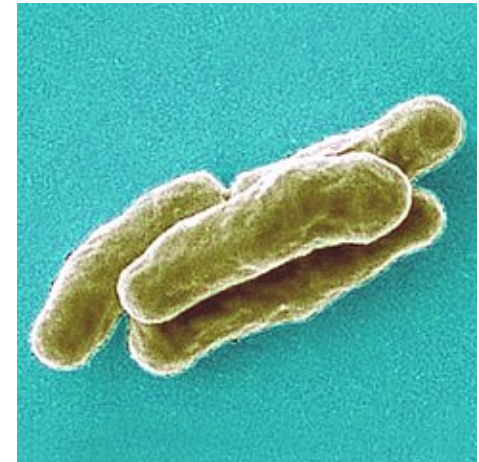


FIG. 2. Structures of mycolic acids.

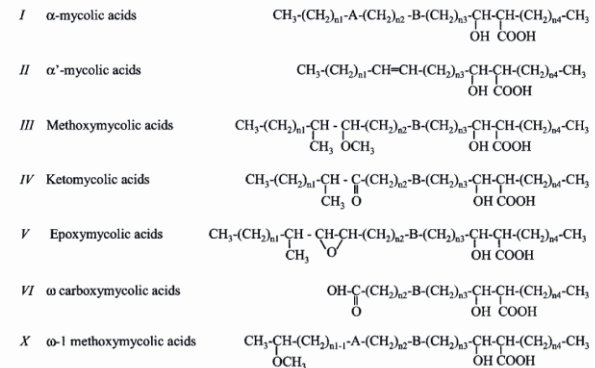
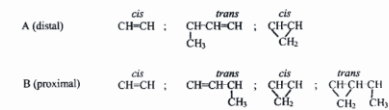


Figure 1. Structures of the major mycolic acids described in mycobacteria.



The main values of n_1 and n_3 are 15, 17, and 19; those of n_2 depend on the nature of A and B. When no methyl branch is present in A and B, or when a methyl branch occurs in both A and B, n_2 is 12, 14, and 16. In contrast, when a methyl branch is present in A or B, n_2 is 13, 15, or 17. n_4 is always 19, 21, or 23.

Mykolové kyseliny

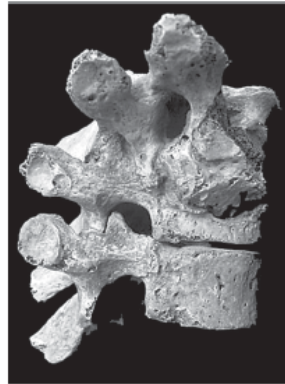


Fig. 1: spinal tuberculosis. The affection of the upper thoracic vertebrae resulted in the collapse of T2 and ankylosis of T1-3. Site: Magyarhomorög-Könyvadómb, X-XI centuries grave No. 94, female, adult.

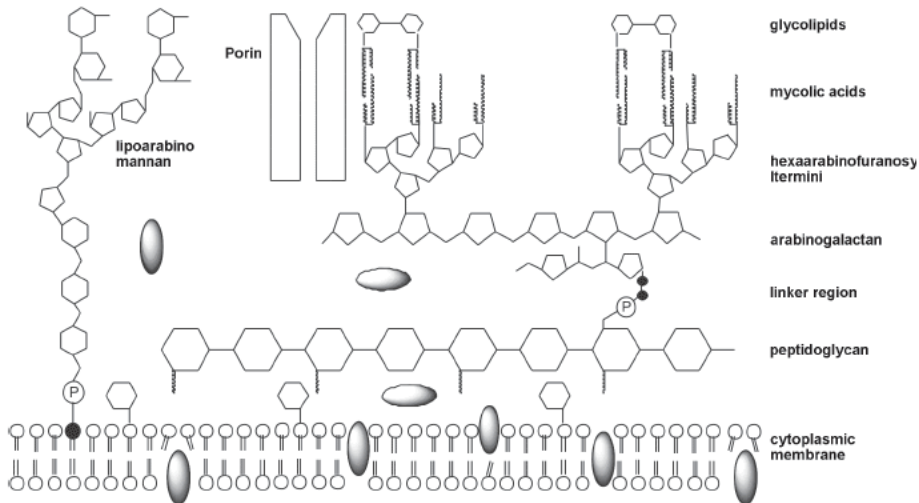


Fig. 1: schematic representation of the mycobacterial cell wall (not drawn to scale). The cytoplasmic membrane is encapsulated by a layer of peptidoglycan. The peptidoglycan backbone is attached to arabinogalactan through an unusual disaccharide phosphate linker region. The arabinogalactan is a branched-chain polysaccharide consisting of a proximal galactose chain linked to a distal arabinose chain. The hexaarabinofuranosyl termini of arabinogalactan are esterified to mycolic acids. The mycolic acid chains are shown perpendicular to the cytoplasmic membrane with the exposed chains interacting with the mycolic chains of trehalose dimycolate. Another major component non-covalently associated to the mycobacterial cell wall is the immunogenic lipoarabinomannan, which is attached to the cytoplasmic membrane by a phosphatidylinositol anchor. Small and hydrophilic solutes diffuse through water-filled protein channels, porins, whereas hydrophobic compounds use the lipid pathway. Proteins are represented by solid oval bodies.

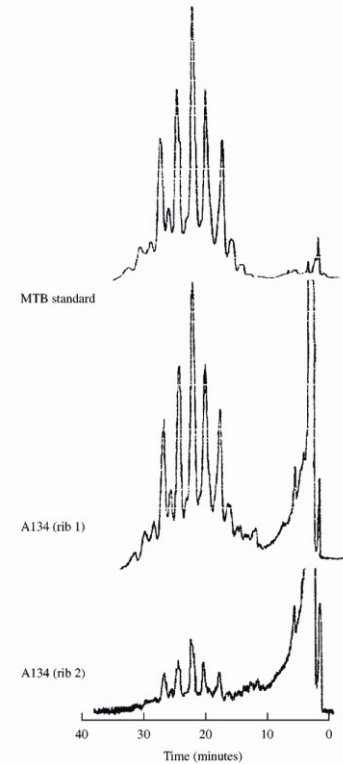


Fig. 2 Initial reverse-phase HPLC separations of anthrylmethyl esters of total mycolic acids from A134 (ribs 1 and 2), and the *Mycobacterium tuberculosis* control. The total fraction of mycolic acid derivatives was collected, in each case, for subsequent analysis by normal-phase HPLC (Fig. 3). Conditions are detailed in 'Materials and Methods'.

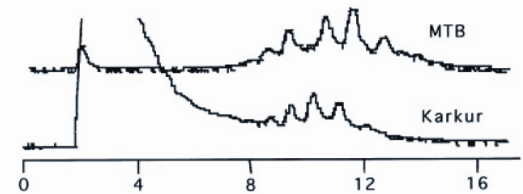
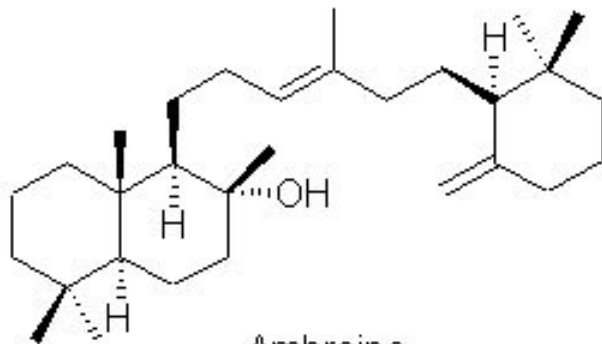


Fig. 2 Initial reverse-phase HPLC separations of anthrylmethyl esters of mycolic acids from calcified pleura from Karkur, compared with those from *Mycobacterium tuberculosis* (MTB) standard. Methods are detailed in Minnikin *et al.* 1993

Ambra

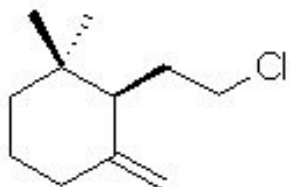
Ambra je nahnědlá látka, která plave na hladině a může tvořit údajně až 500 kilogramů těžké plovoucí tvary. Tato látka se tvoří ve střevě vorvaně a jeho tělo jí vylučuje společně s trusem.



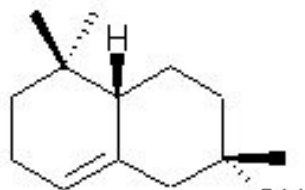
Ambra byla v SZ Africe známa již minimálně od 9. stol. th Century. Jako parfém ji používali Ludvík XV i Alžběta I (slouží jako stabilizátor parfémů). Rozpuštěna ve víně se užívala jako afrodiziakum.



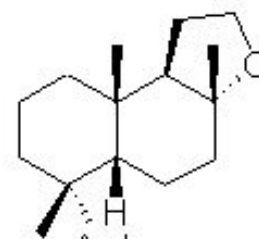
Ambra obsahuje 46 % sterolů cholestanolového typu včetně (+)-epi-koprosterinu a triterpenového alkoholu (-)-ambreinu (25-45 %), který je bez zápachu, ale tento materiál je prekurzorem dalších vonných sloučenin vznikajících autooxidací, slunečním zářením a mořskou vodou, jako je (-)-gamma-cyklogeranylchlorid a (-)-gamma-bicyklohomofarnesal. Materiál si údajně dokáže udržet svou vůni po staletí a obvykle zůstává jako amorfní hmota bez tendence ke krystalizaci.



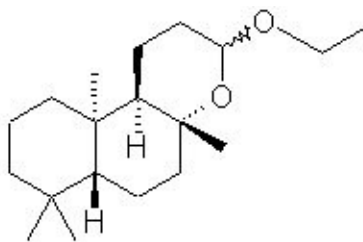
gamma homocyclo
geranyl chloride



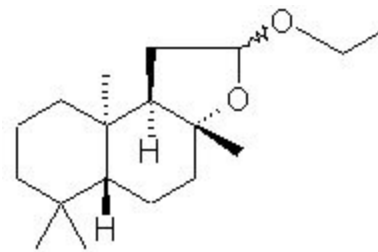
alpha-ambrinol



Ambroxan



1



2

Degradační produkty ambreinu: 13-ethoxy-8a,13-epoxy-14,15,16-trinorlabdane (1) and 12-ethoxy-8a,12-epoxy-13,14,15,16-tetranorlabdane (2).

Parafin

Parafín je bílá, v surovém stavu spíše nažloutlá až nahnědlá, amorfní směs pevných uhlovodíků řady C_nH_{2n+2} (alifatických alkanů). Je bez chuti a zápachu, ve vodě nerozpustný. Získává se při destilaci ropy nebo krystalizačním odparafínováním hnědouhelného dehtu, popřípadě se vyrábí katalytickou syntézou.

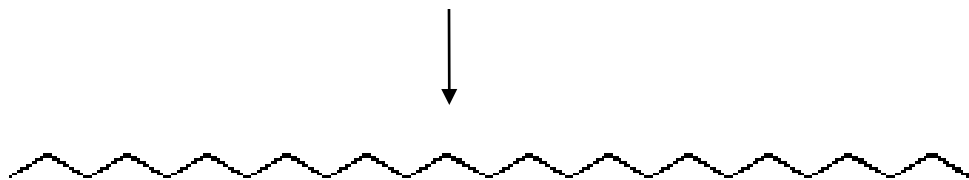
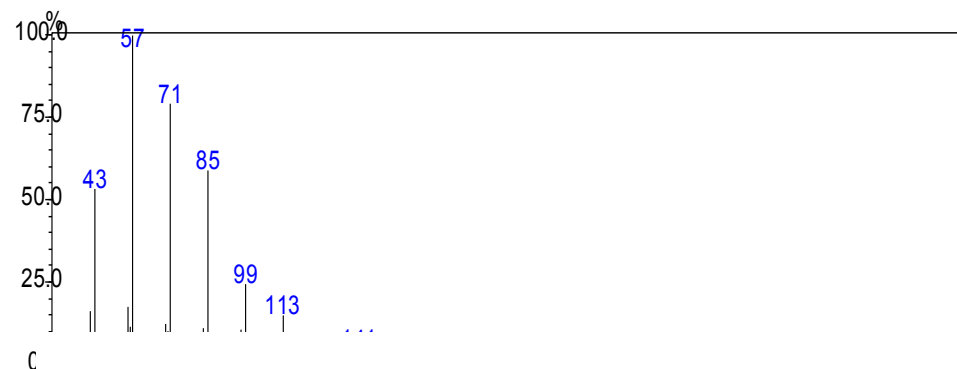
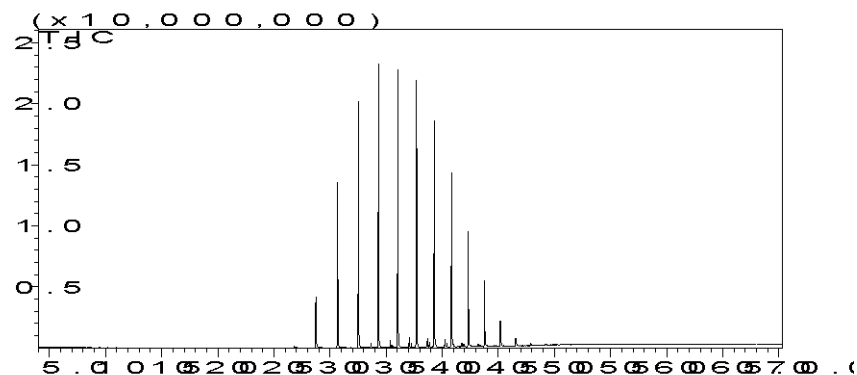


Parafin se používá k výrobě svíček, v kosmetice, izolace a impregnace materiálů proti vlhkosti.

Boskovice, kostel sv. Jakuba

(krypta Morkovských ze Zástřizl)

Parafin patrně z doby otevření krypty r. 1912



MS spektrum n-pe

Nukleové kyseliny

TABLE 85 Nucleic Acids

Abbreviation	Full name	Characteristic function
DNA	Deoxyribonucleic acid	Carries genetic instructions for making living organisms
n-DNA	Nuclear deoxyribonucleic acid	DNA enclosed within the chromosomes, in the nucleus of the cell; inherited from both parents
mt-DNA	Mitochondrial deoxyribonucleic acid	DNA in cell mitochondria; inherited only from the mother
RNA	Ribonucleic acid	Transfers genetic information from DNA to proteins synthesized by the cell
m-RNA	Messenger ribonucleic acid	Transfers genetic information from nuclear DNA to the protein synthesized in cell ribosomes
r-RNA	Ribosomal ribonucleic acid	A stable, structure component of ribosomes
t-RNA	Transfer ribonucleic acid	Picks up specific amino acids and transfers them to the appropriate location in m-RNA during protein synthesis

DNA v paleodemografii

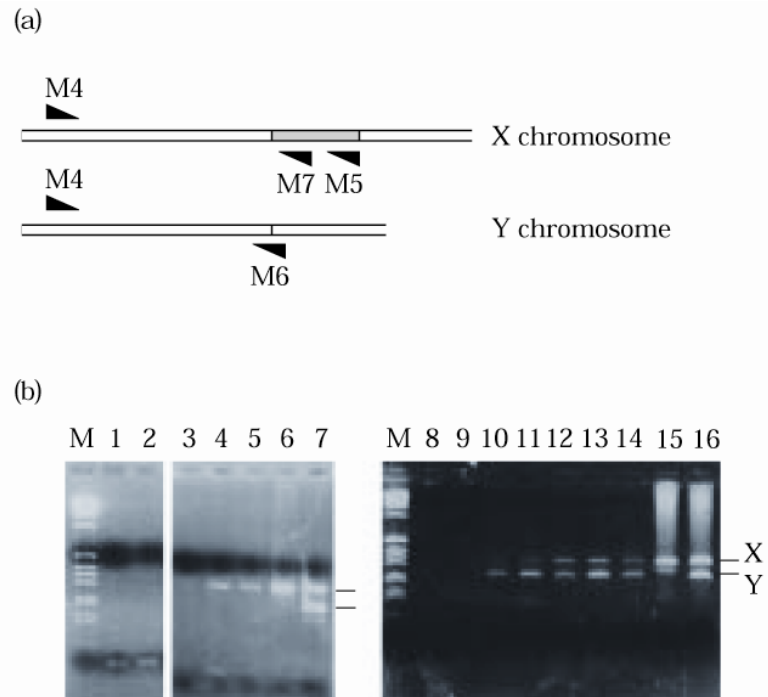
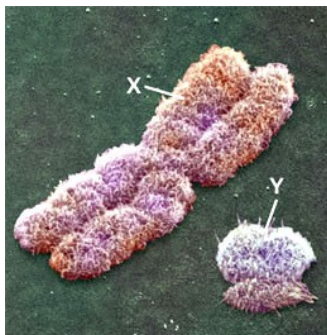
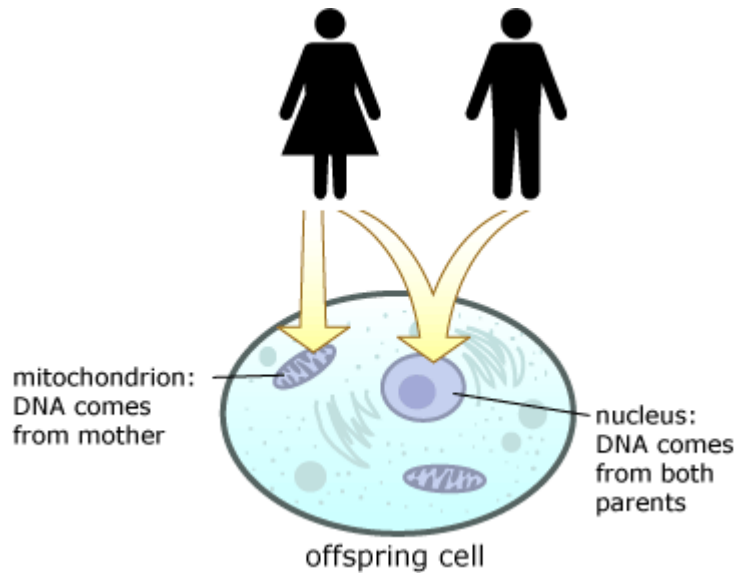


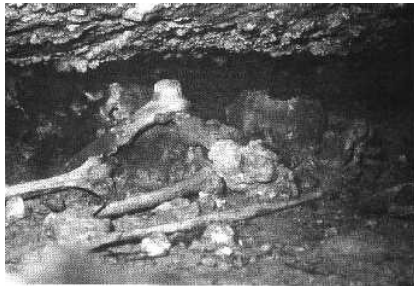
Figure 2. (a) Part of the amelogenin encoding gene showing the location of the PCR primers. Fragment deleted in the Y chromosome is indicated. (b) Sex identification of Ashkelon infants: M—size marker (1 kb DNA ladder); lanes 1, 8, “no DNA” PCR control; lane 2, “blank extraction” control; lanes 3–5, specimen No. 100; lanes 9–11, specimen No. 94; lanes 12–14, specimen No. 96; positive controls: lanes 6, 15, modern female DNA; lanes 7, 16, modern male DNA.

Určování příbuznosti

Liechtenstein Höhle

Dorste, Dolní Sasko, mladší doba bronzová

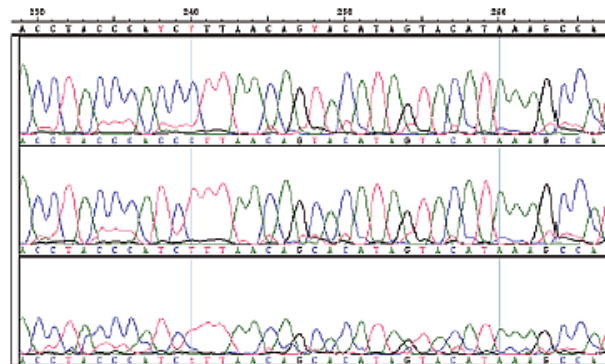
Kultiště? Rodová hrobka?



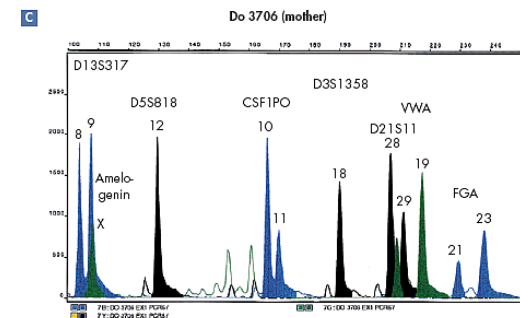
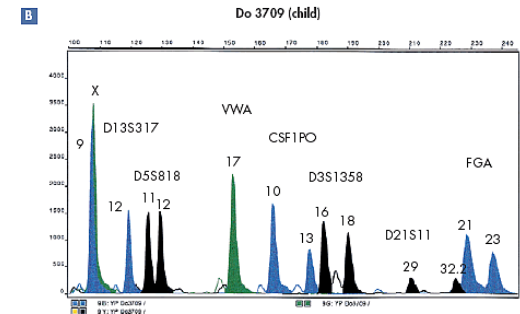
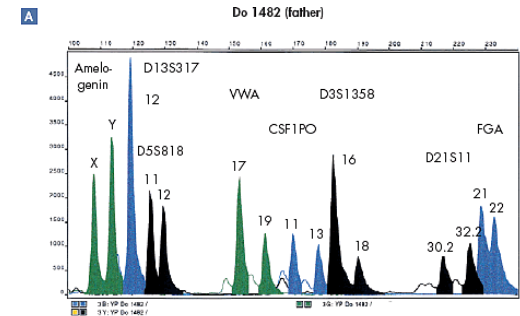
Do 1482
(father)
Haplogroup H

Do 3709
(child)
Haplogroup T

Do 3706
(mother)
Haplogroup T



Polymorphic sites



Archeozoologie

Dudley Castle, Leceistershire

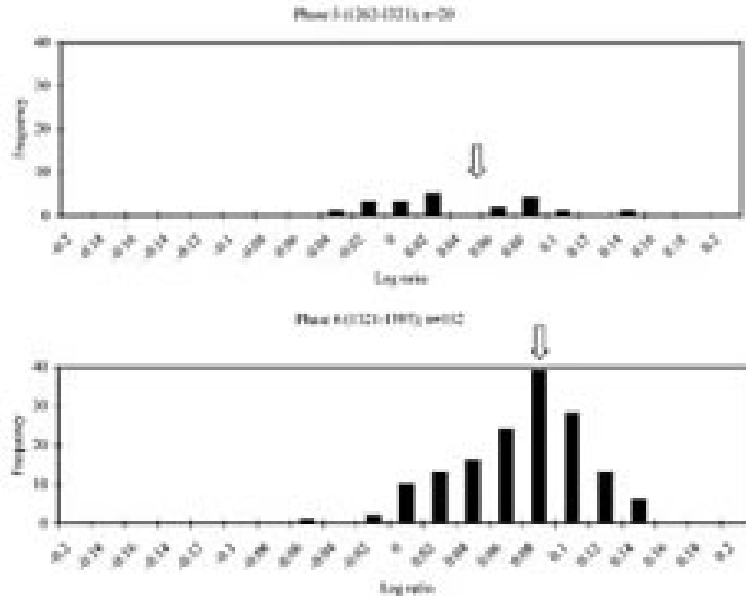


Fig. 2. Log ratios of cattle width measurements at Dudley Castle by phase. The standard is derived from measurements taken on fifteenth-century cattle bones from Lancaster Castle (Albanillo and Davis, 1996). An arrow indicates the mean of each dataset. Measurements included: tibia Bd, astragalus GL1, Bd, Du; (after von den Driesch, 1976); humerus BT, HTC; (after Bell and Payne, 1993); metapodial GL, SD, Bd, a, b, 1, 3, 4 (after Davis, 1992).



From Thomas *et al.* 2005: 77

Fylogenetická příbuznost pleistocénních medvědů

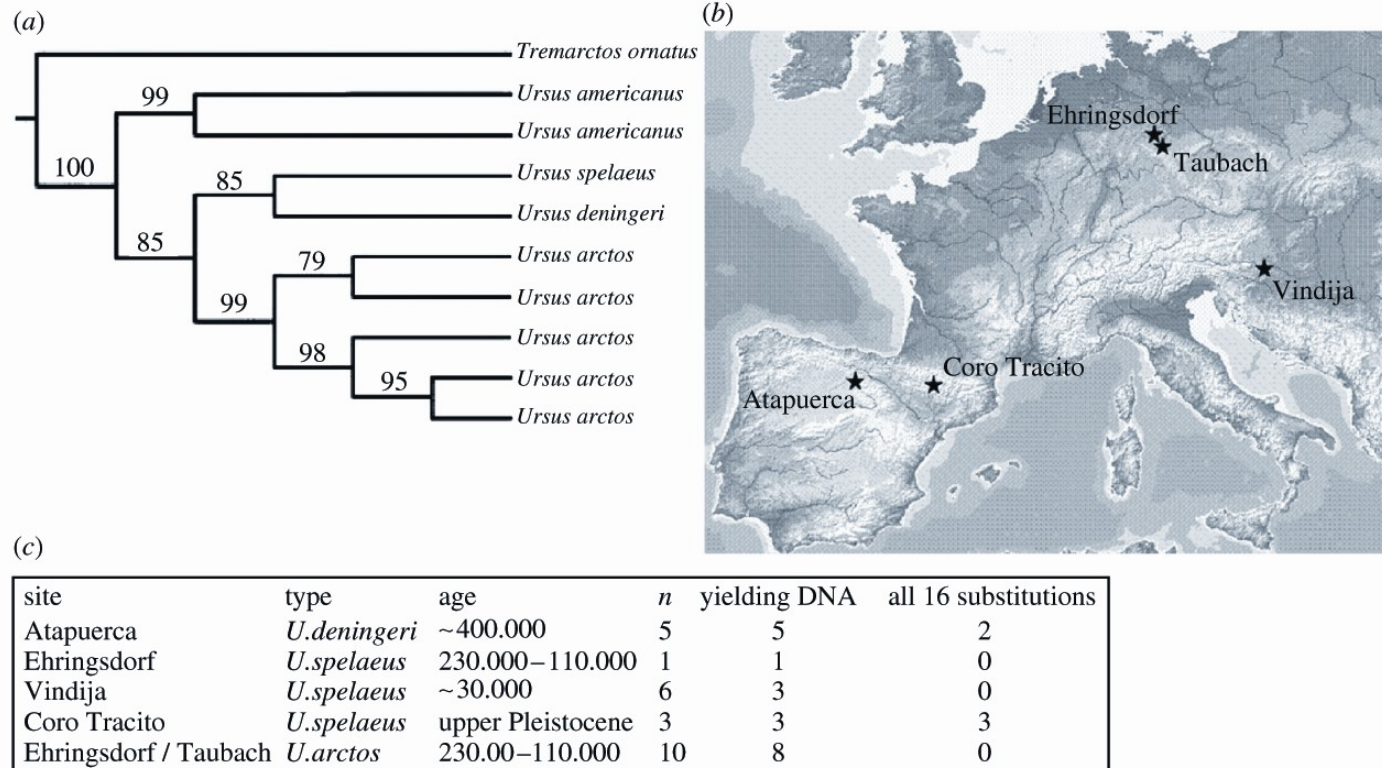


Figure 1. (a) Phylogenetic position of *Ursus deningeri*. Maximum parsimony tree using molecular data from cytochrome *b*. The grouping of *U. deningeri* and *U. spelaeus* was well supported (1000 replicates). (b) Sites for the caves with bear samples. (c) Out of 25 samples, 20 yielded bear DNA, out of which 5 yielded all 16 polymorphic sites.

„Molekulární hodiny“

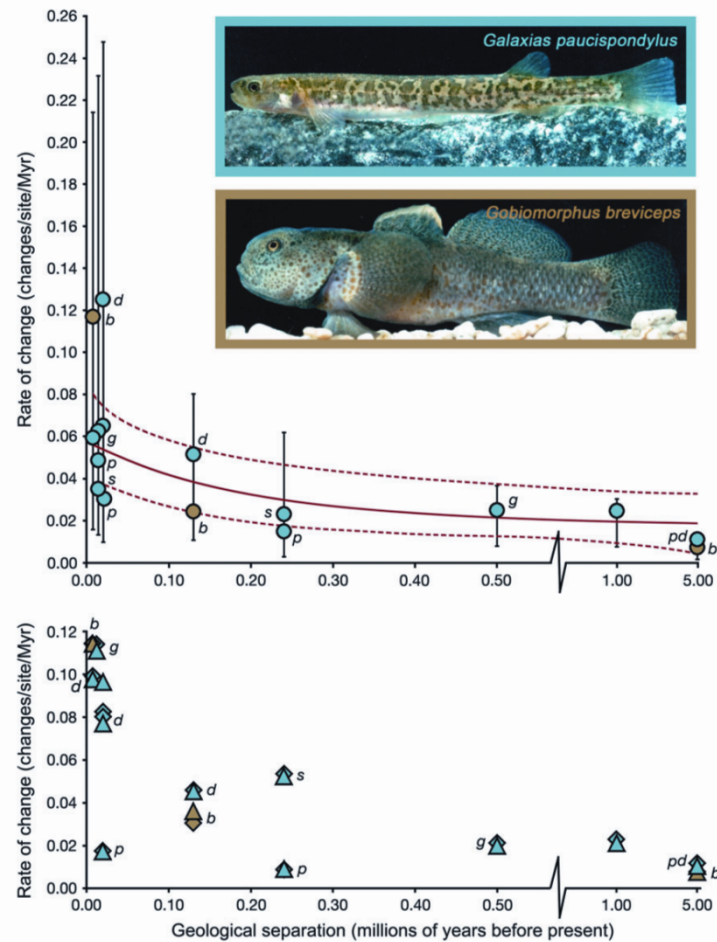
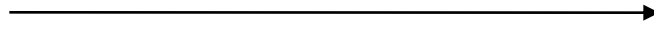


FIG. 3.—Molecular clock calibrations (nucleotide changes/site/Myr) derived from dated isolation events of New Zealand freshwater fish populations. Blue symbols represent galaxiid divergences (Galaxiidae), and brown symbols represent *Gobiomorphus breviceps* (Eleotridae). Letters indicate rates derived from multiple events for the same species (g, *Galaxias gollumoides*; d, *Galaxias divergens*; s, *Galaxias 'southern'*; p, *Galaxias paucispondylus*; b, *Gobiomorphus breviceps*). Where ages are represented by both minimum and maximum estimates (table 1), we employed the latter, yielding minimum estimates of rates. The top graph represents coalescent-based estimates (error bars are the 90% highest posterior density). The red lines are vertically translated exponential decay curves for galaxiid data representing best-fit estimates (solid line, $y = 0.01876 + 0.03911 \times e^{-5.25878x}$) and upper and lower 95% confidence intervals of model parameters (supplementary text S1, Supplementary Material online). The bottom graph represents “simple” rates based on net sequence divergences under either uncorrected (*p* distance, triangles) or HKY (diamonds) models of nucleotide substitution. Two young calibration events yielded negative simple rates (maximum intracatchment divergence exceeded intercatchment divergence, table 1) and are not shown on the lower graph.

DNA v paleopatologii

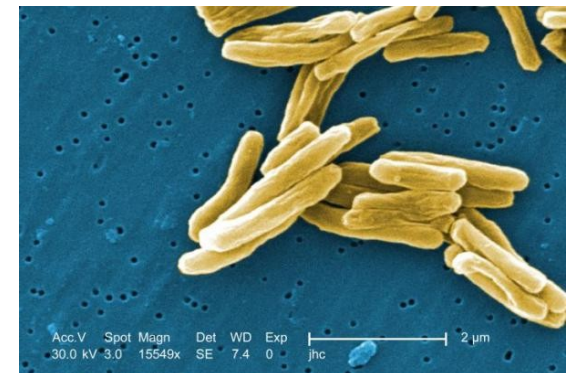
Tuberkulóza



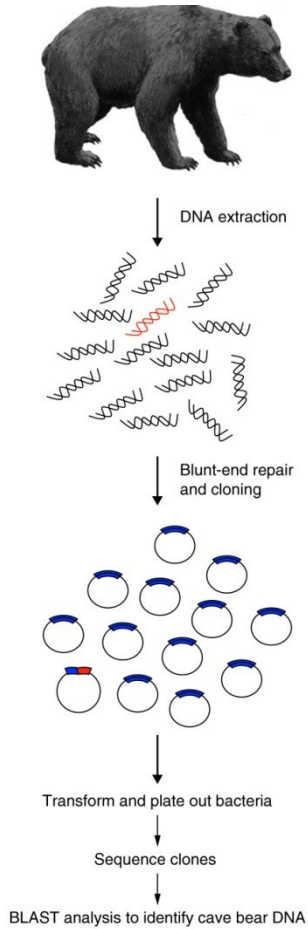
Lepra

Malárie

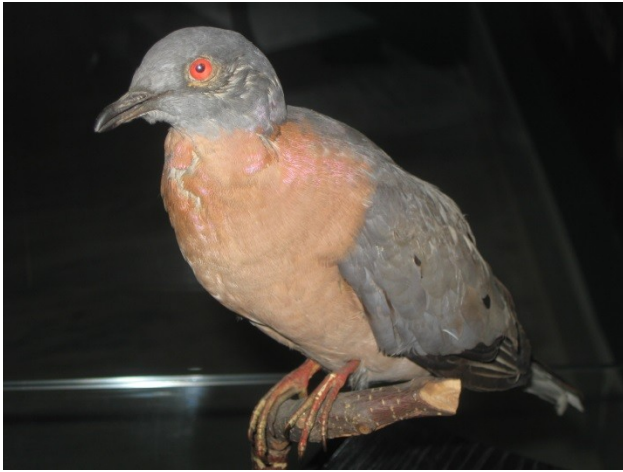
Černý mor



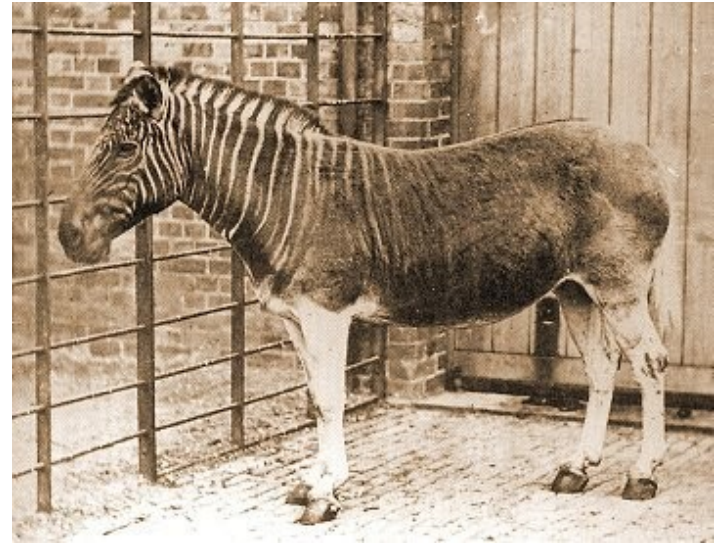
Klonování vyhynulých živočichů



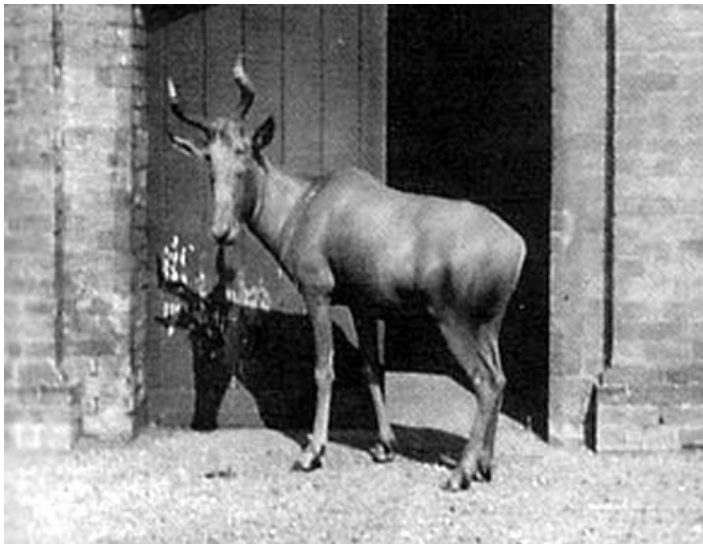
Medvěd jeskynní



Holub stěhovavý (1914)



Zebra qagga (1883)



Buvolec stepní (1923)



Vakovlk (tasmánský tygr) (1930)

Pyrenejský kozorožec

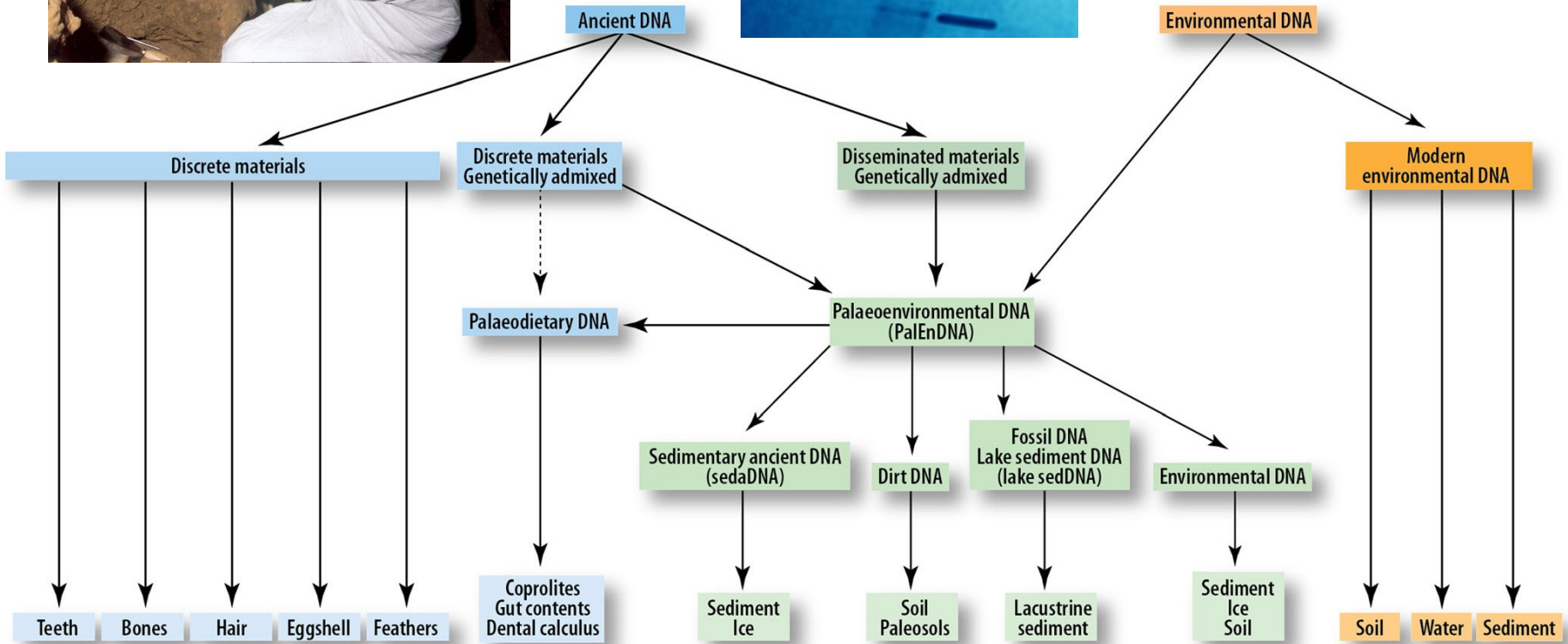
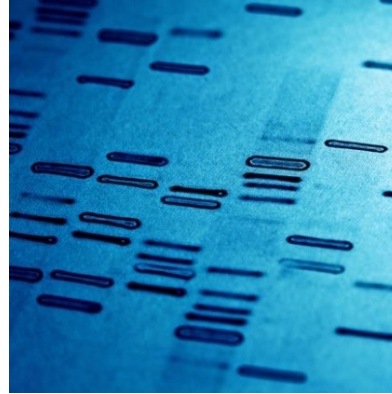
Poslední pyrenejský kozorožec, samice Celia, byla nalezena mrtvá pod padlým stromem v lednu 2000.



Kozorožec pyrenejský (2000)

Jedná se o první druh, který byl klonován, ale mládě uhynulo pouhých 7 minut po narození na defekt plic.

Analýza DNA



Degradace DNA

	Hydrolyse	Oxydation	Autolyse	Microorganismes
pH alcalin	↘			
Température basse	↘	↘	↘	↘
Dessiccation	↘	↘	↘	
Pression	↘	↘		
Présence de matière organique		↘	↘	
Faible taux d'oxygène		↘		
Adsorption	↘		↘	

Tableau I. — Tableau récapitulatif du rôle des différentes variables environnementales sur les facteurs de dégradation de l'ADN (modifié d'après I. de los Santos, 1993). Ce tableau permet de montrer, par exemple, que les températures basses diminuent à la fois l'hydrolyse, l'oxydation, l'autolyse et l'action des micro-organismes et ainsi de suite... Les environnements qui cumulent ces différentes variables sont plus favorables à la conservation de l'ADN.

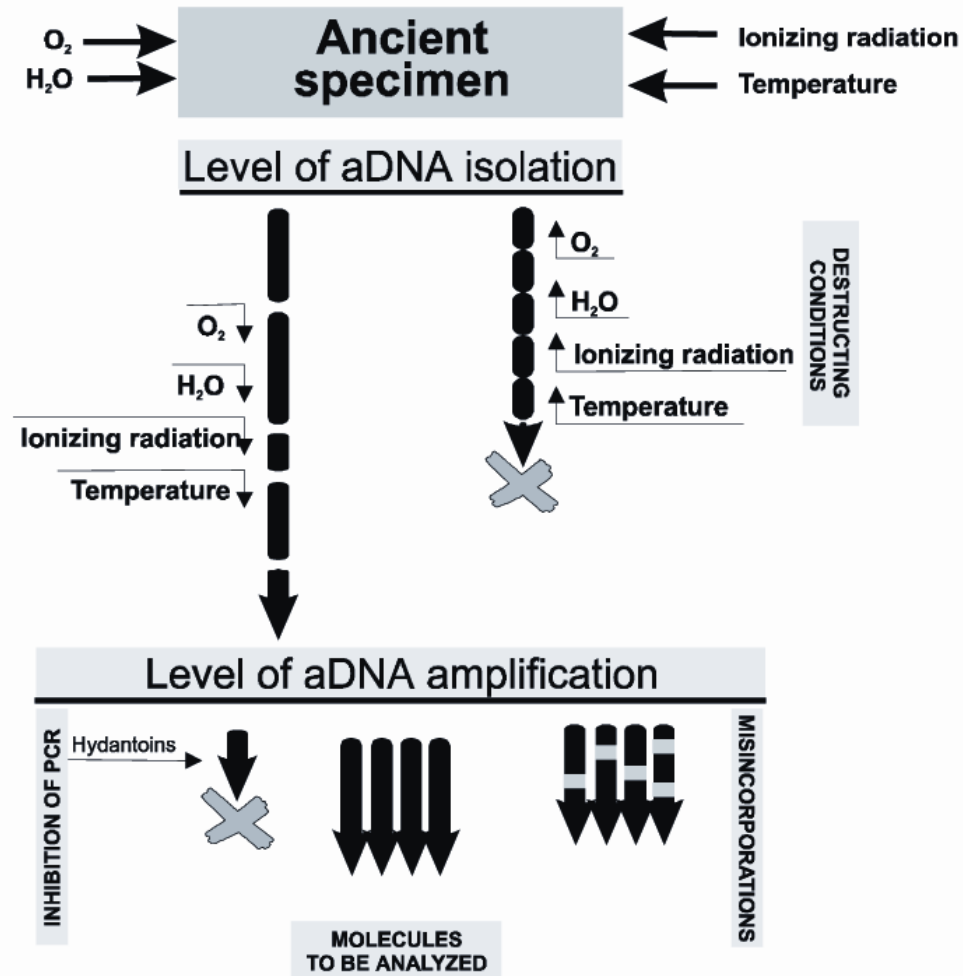


Fig. 2. Possible features influencing ancient DNA retrieval.

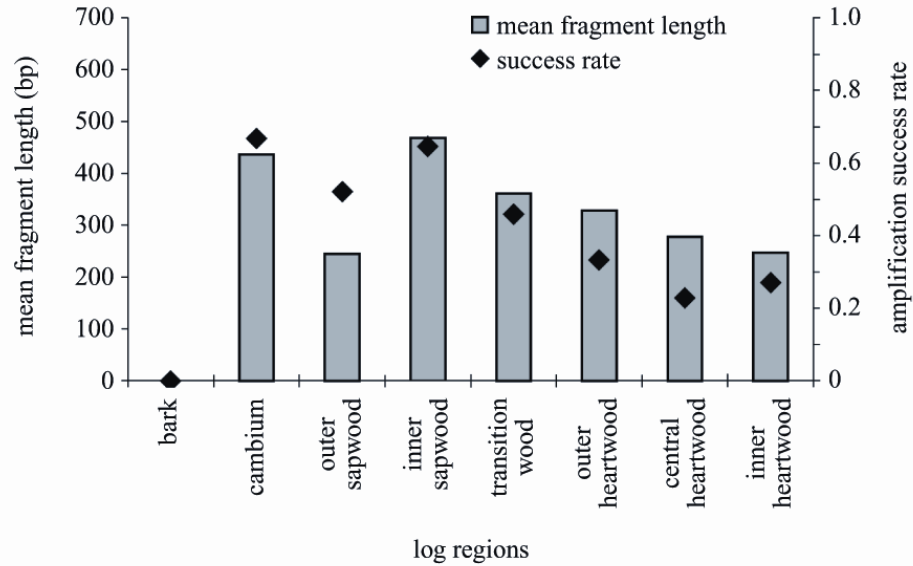


Figure 1. Mean amplified fragment length and amplification success rate on different regions of logs 1 and 8–10 (grey bars, mean fragment length; diamonds, success rate).

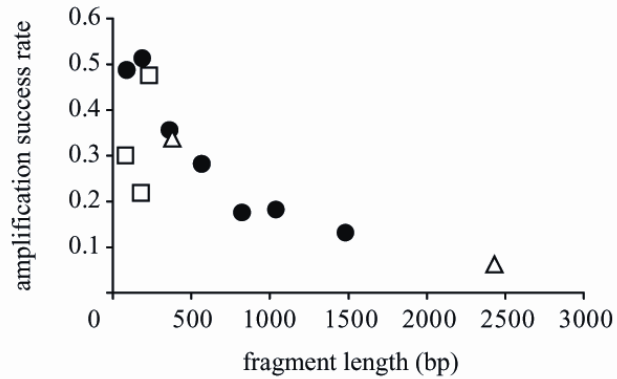


Figure 2. Amplification success rate related to amplified fragment length (black circles, chloroplast, open squares, nuclear; open triangles, mitochondrial).

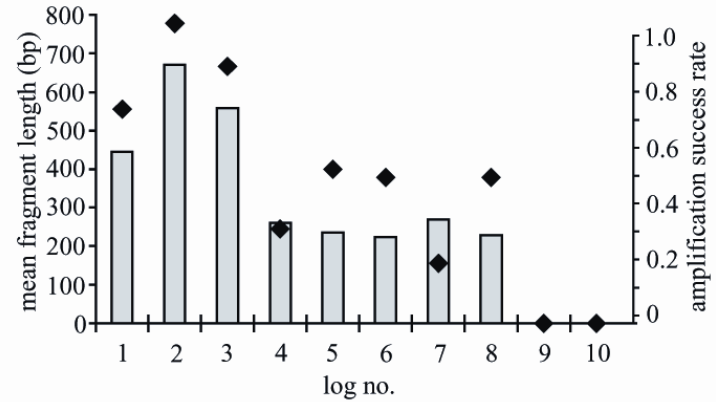


Figure 3. Mean amplified fragment length and amplification success rate on different heartwood logs (grey bars, mean fragment length; diamonds, success rate).

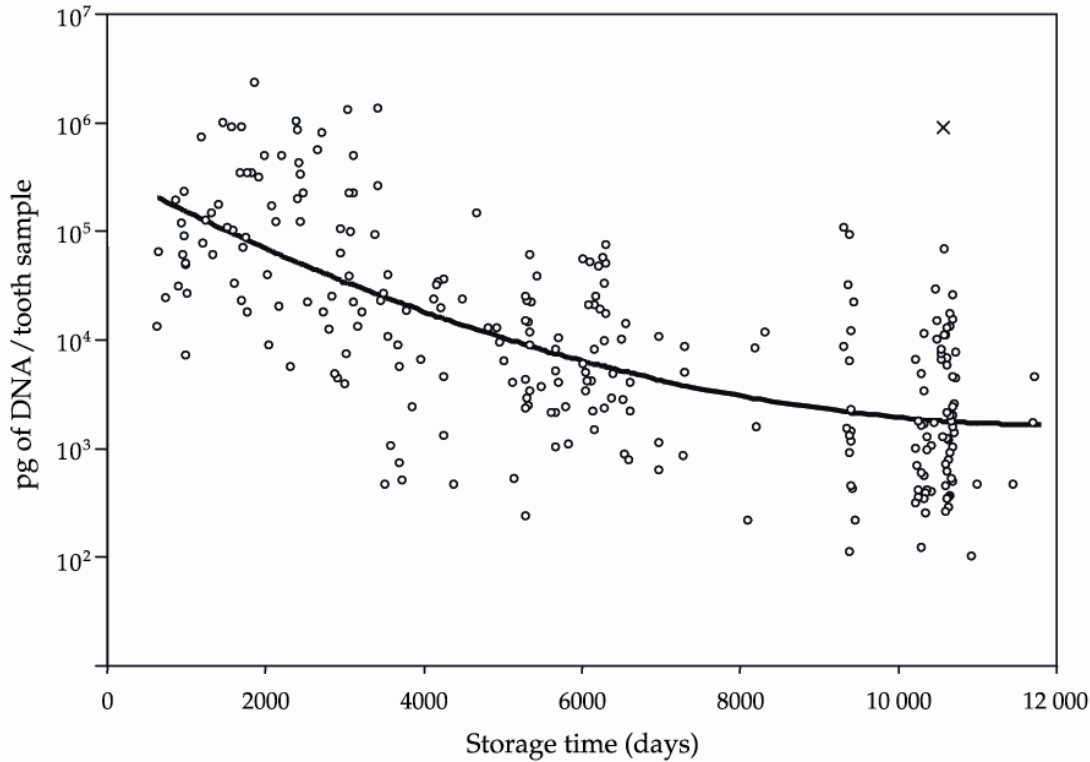


Fig. 1 Relationship between the estimated quantity of nuclear DNA (c-myc 81 assay) in DNA extractions from teeth vs. storage time. Note that values for the estimated quantity of nuclear DNA are shown in a logarithmic scale on the y axis. The cross refers to an outlier, by excluding this sample the equation for the regression is: $\text{Log}(\text{DNA quantity}) = 5.550 - 3.862\text{E-}4 * \text{time} + 1.597\text{E-}8 * \text{time}^2$; $r^2 = 0.471$).

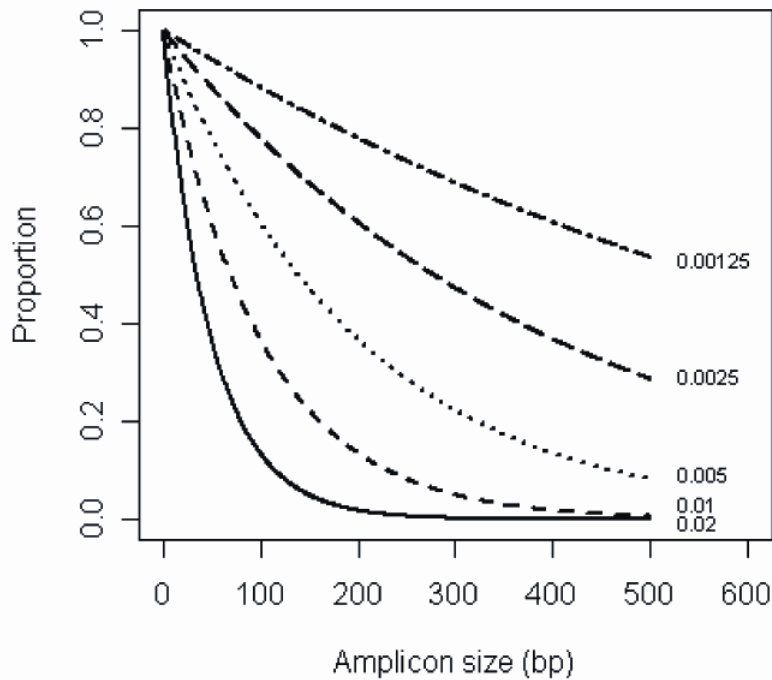


Figure 1
Theoretical proportion of amplifiable fragments versus amplicon size after a random degradation process. Results are shown for cases in which the probability of a nucleotide being damaged (λ) is: 0.00125, 0.0025, 0.005, 0.01 or 0.02.

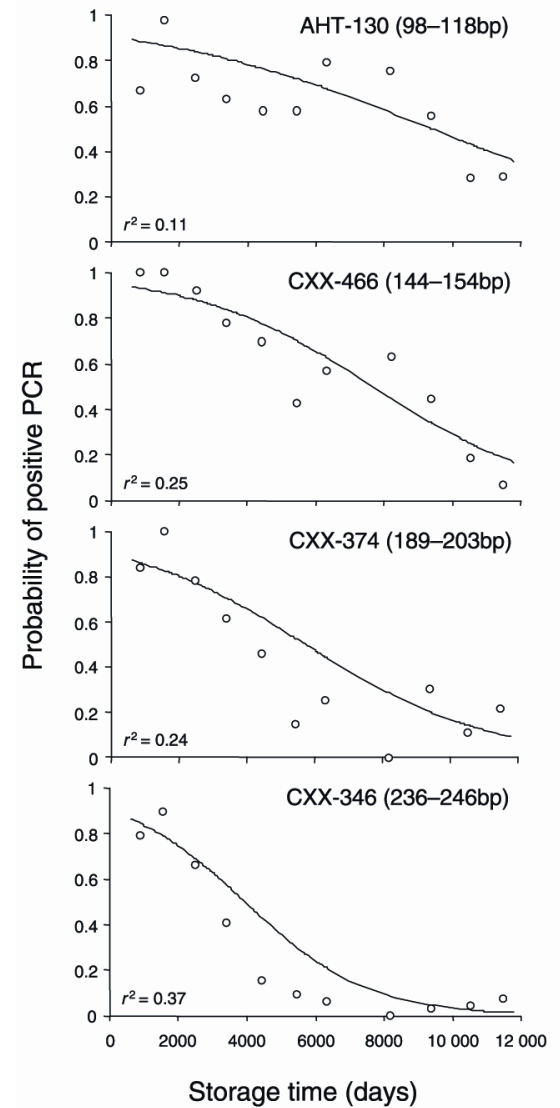


Fig. 2 Probability of positive PCR amplification in four microsatellites different in fragment size vs. storage time of historic teeth samples. Shown are the predicted models of the logistic regressions for each locus based on two independent PCR amplifications per loci for 257 extracts. Circles indicate categorical means for observed values.

Lesion frequencies (f_{lesion}), rate constants (k), and half-lives ($T_{1/2}$)

Lesion type	Time (YBP)	f_{lesion}	k (sec ⁻¹)	$T_{1/2}$ (yr)
DSB ^a	10,400 → 300,000–400,000	0.00013	3.7×10^{-17}	8×10^8
	10,400 → 400,000–600,000	0.00037		
SSB ^b	10,400	0.00053	1.4×10^{-15}	1.7×10^7
	19,000	0.0009		
ICL ^c	10,400	0.44	1.0×10^{-13}	2.2×10^5
	19,000	0.49		
	300,000–400,000	0.85		
	400,000–600,000	0.87		

YBP, years before present.

^a Lesion frequencies of double-stranded breaks (DSBs) were obtained by comparing number average molecular length (NAML) of double-stranded DNA from two sample pairs of different ages (10,400 *vs.* 300,000–400,000 YBP and 10,400 *vs.* 400,000–600,000 YBP).

^b Lesion frequencies of single-stranded breaks (SSBs) were obtained by comparing NAML of double-stranded and single-stranded DNA from the same samples (10,400 and 19,000 YBP).

^c Lesion frequencies of interstrand crosslinks (ICLs) were calculated on the basis of data from a PicoGreen assay on samples dated to be 10,400, 19,000, 300,000–400,000, and 400,000–600,000 years old. From the lesion frequencies rate constants were calculated followed by calculations of half-lives. See text and supplemental material (<http://www.genetics.org/supplemental/>) for details.

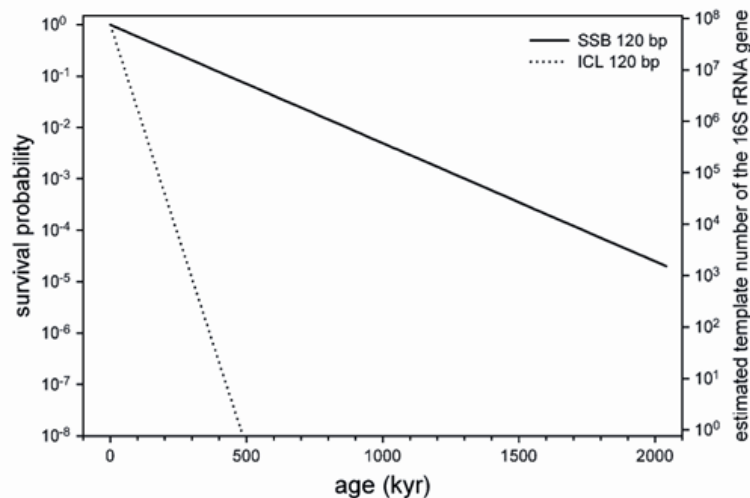


FIGURE 1.—The survival probability of 120-bp DNA fragments in Siberian permafrost estimated from rate constants for single-stranded breaks and interstrand crosslinks. The secondary y-axis shows the corresponding number of remaining templates of bacterial 16S rRNA genes that would be present in one PCR reaction (as performed in WILLERSLEV *et al.* 2004a) assuming an initial bacterial density of 10^8 g⁻¹ of permafrost soil when entering the permanently frozen state. The probability of fragments avoiding interstrand crosslinks was estimated from the rate constant estimated by the PicoGreen assay by assuming that each crosslink affects the affinity for PicoGreen in a 10-bp part of the double-stranded DNA. For further details see text.

Degradace DNA

Jako indikátor při výběru vzorku pro analýzu DNA se použila míra racemizace Asp: vysoký obsah D-formy = malá pravděpodobnost dochování použitelné DNA.

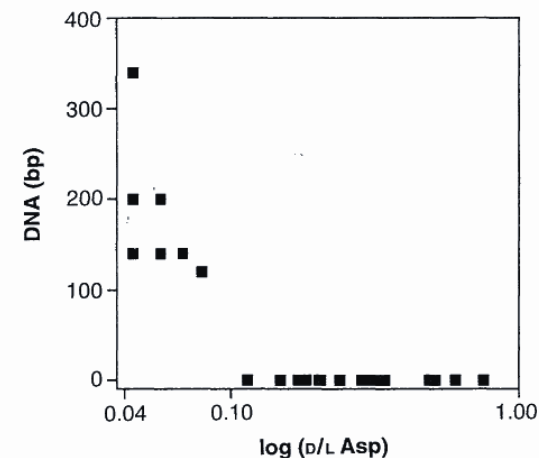
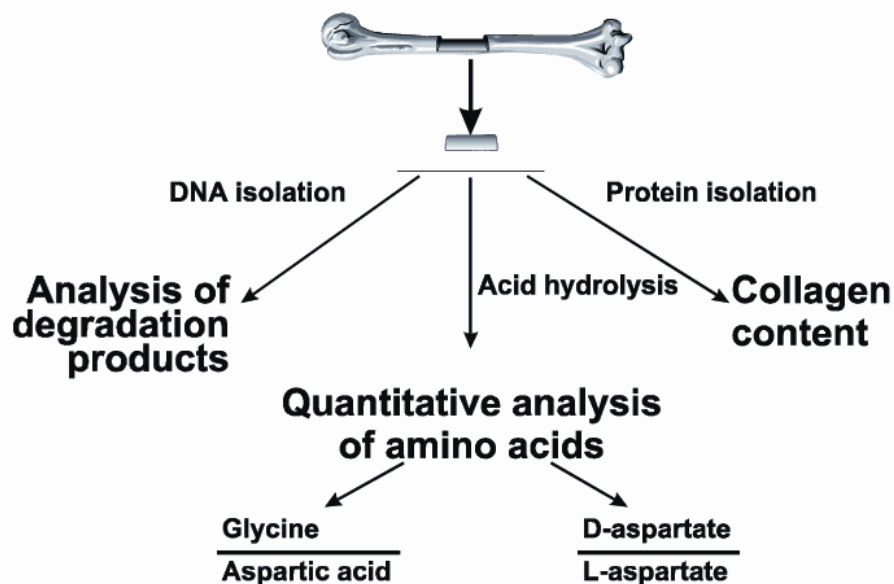
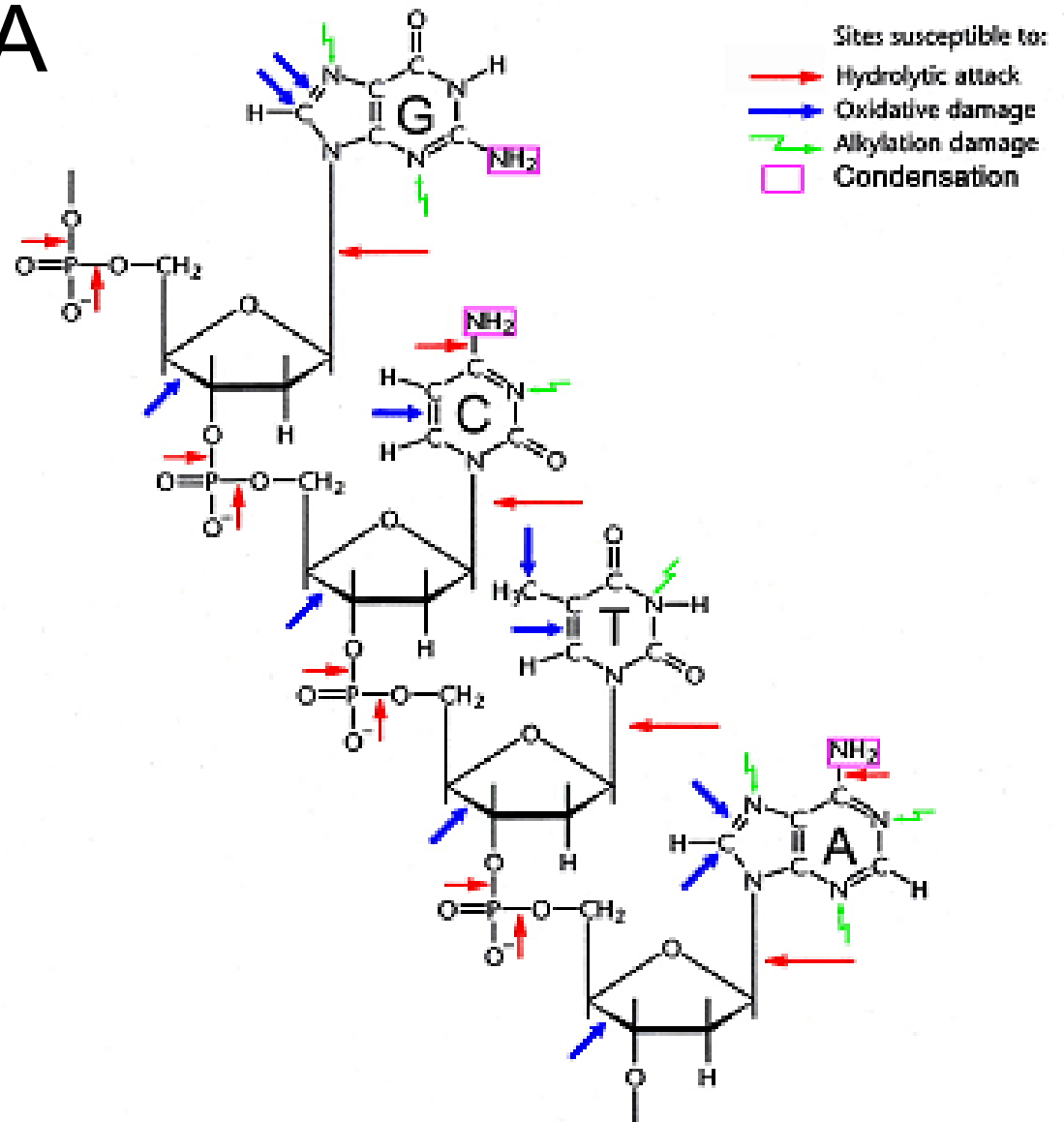


Fig. 1. Extent of Asp racemization plotted (as the logarithm of the D/L ratio of Asp) against the maximum length of DNA amplified (in base pairs).

Fig. 5. Scheme of procedures to be undertaken when verifying macromolecular content of an ancient specimen before DNA extraction.

Degradace DNA



Mechanismy

Hydrolýza

Oxidace

Kondenzace (Maillardova reakce, vznik Schiffových bází)

Deaminace

Oxidační produkty DNA

Table 2. Amounts of damaged nucleotide bases (nmol/mg) in the samples analyzed. Sample numbers refer to Table 1

Sample	5-OH-5-MeHyd	5-OH-Hyd	5-OH-Ura	5,6-diOH-Ura	FapyAde	8-OH-Ade	FapyGua	8-OH-Gua
C	0.42 (0.06)	0.16 (<0.01)	0.05 (0.01)	N/A	0.07 (0.01)	0.15 (<0.01)	0.11 (0.01)	0.75 (0.01)
1	1.82 (0.65)	1.20 (0.40)	0.58 (0.30)	N/A	0.33 (0.05)	0.22 (0.11)	0.42 (0.06)	2.63 (1.59)
2	9.11 (1.46)	8.85 (1.30)	<DL	<DL	<DL	<DL	<DL	0.98 (0.01)
3	8.22 (1.09)	9.07 (2.10)	<DL	<DL	<DL	0.58 (0.22)	<DL	1.46 (0.40)
4	11.17 (0.81)	10.53 (2.92)	<DL	<DL	<DL	<DL	<DL	0.65 (0.03)
5	15.81 (5.21)	17.09 (1.18)	<DL	<DL	<DL	<DL	<DL	1.53 (0.28)
6	2.08 (0.43)	1.19 (0.16)	0.86 (0.18)	N/A	0.21 (0.10)	0.13 (0.05)	0.29 (0.11)	0.44 (0.12)
7	3.09 (0.27)	1.72 (0.43)	0.67 (0.22)	N/A	0.23 (0.01)	0.27 (0.02)	0.44 (0.08)	0.94 (0.18)
8	14.69 (2.59)	19.10 (6.38)	<DL	<DL	<DL	<DL	<DL	1.31 (0.10)
9	1.25 (<0.01)	0.70 (<0.01)	0.20 (<0.01)	N/A	0.23 (<0.01)	0.29 (0.12)	<DL	1.67 (0.51)
10	12.73 (1.88)	9.86 (1.71)	<DL	<DL	<DL	<DL	<DL	0.76 (0.23)
11	0.78 (0.35)	0.66 (0.27)	N/A	1.10 (0.20)	0.51 (0.13)	0.67 (0.23)	<DL	0.93 (0.32)

Standard deviations are given within parentheses. N/A designates compounds that were not analyzed in the samples indicated and <DL indicates that a compound was below the detection limit (0.005 nmol/mg). In addition to the compounds shown, 5-hydroxycytosine was analyzed and was found to be below the detection level.

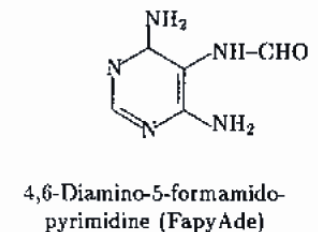
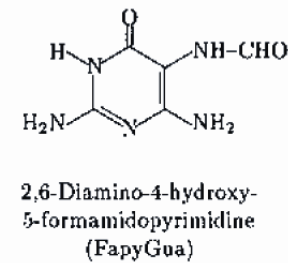
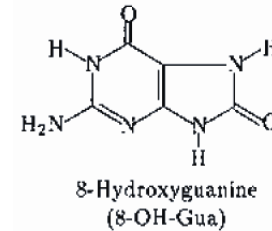
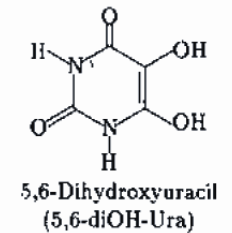
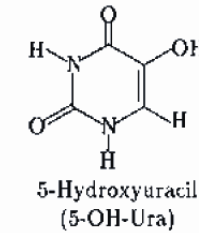
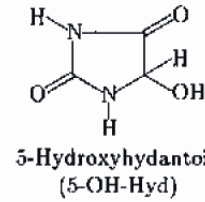


Figure 2. Structures of eight oxidative base modifications detected in the ancient DNA. For 8-OH-Gua and 8-OH-Ade the keto forms, which predominate in aqueous solution, are shown.

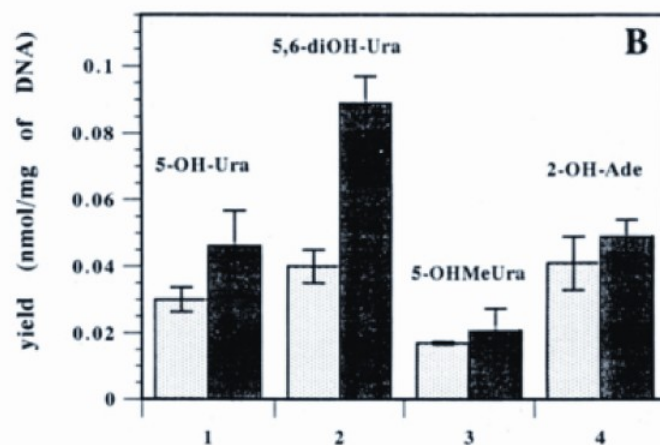
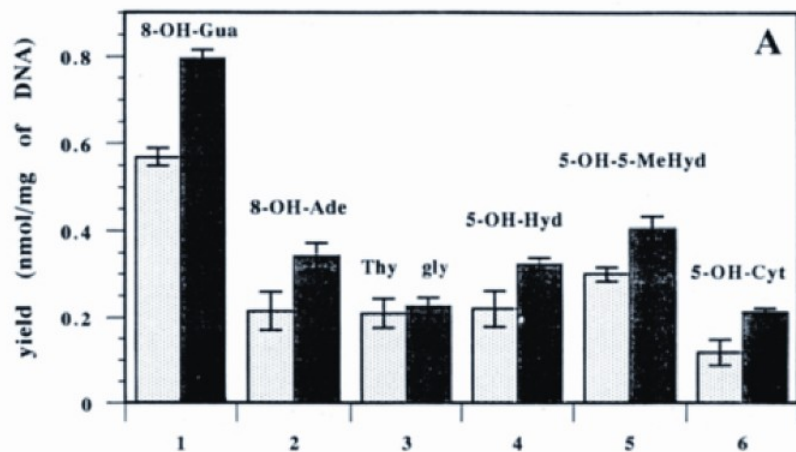


FIGURE 4: Amounts of modified bases in control DNA samples and in DNA samples exposed to 10 kJ/m² of UV irradiation at 254 nm. Light bars, control samples; dark bars, irradiated samples. (A) Yields of 8-OH-Gua (1), 8-OH-Ade (2), Thy gly (3), 5-OH-Hyd (4), 5-OH-5-MeHyd (5), and 5-OH-Cyt (6). (B) Yields of 5-OH-Ura (1), 5,6-diOH-Ura (2), 5-OHMeUra (3), and 2-OH-Ade (4). Each amount represents the mean of three values that were obtained by measurement of three independently prepared DNA samples. Error bars represent standard deviations.

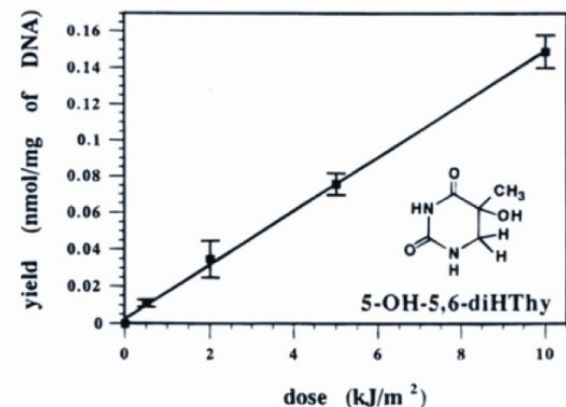


FIGURE 3: Dose-yield plot of 5-hydroxy-5,6-dihydrothymine (5-OH-5,6-diHThy). DNA samples were UV-irradiated (254 nm) at the indicated doses. Each data point represents the mean of three values that were obtained by measurement of three independently prepared DNA samples. Error bars represent standard deviations.

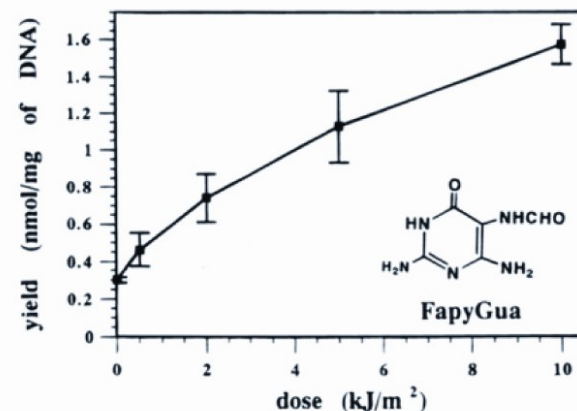


FIGURE 2: Dose-yield plot of 2,6-diamino-4-hydroxy-5-formamidopyrimidine (FapyGua). DNA samples were UV-irradiated (254 nm) at the indicated doses. Each data point represents the mean of three values that were obtained by measurement of three independently prepared DNA samples. Error bars represent standard deviations.

Oxidace

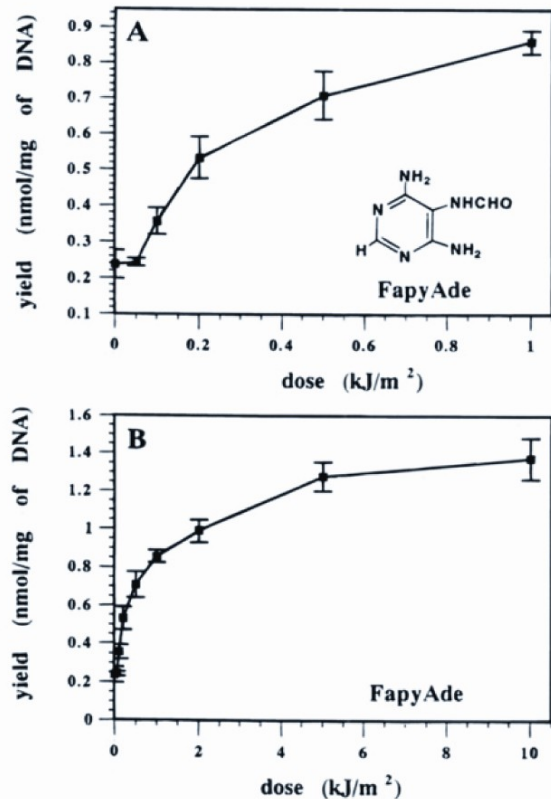


FIGURE 1: Dose-yield plot of 4,6-diamino-5-formamidopyrimidine (FapyAde). (A) In the range of 0–1 kJ/m² of UV irradiation at 254 nm. (B) In the range of 0–10 kJ/m² of UV irradiation at 254 nm. Each data point represents the mean of three values that were obtained by measurement of three independently prepared DNA samples. Error bars represent standard deviations. 1 nmol of a modified base/mg of DNA corresponds to ≈ 32 modified bases per 10^5 DNA bases.

Deaminace

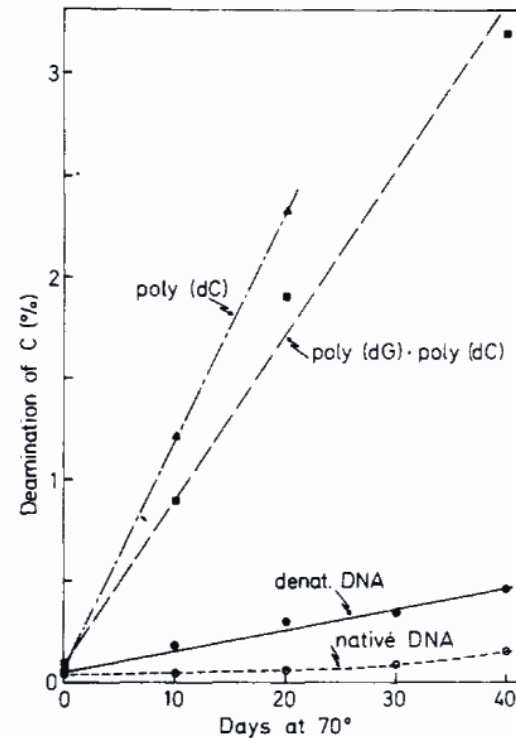


FIGURE 4: Rate of deamination of cytosine residues in different polymers at 70° and pH 7.4 (buffer B): (O - - - O) native *E. coli* DNA; (● — ●) denatured *E. coli* DNA; (■ - - ■) poly(dG)-poly(dC); (▲ - · - · ▲) poly(dC).

Vliv teploty

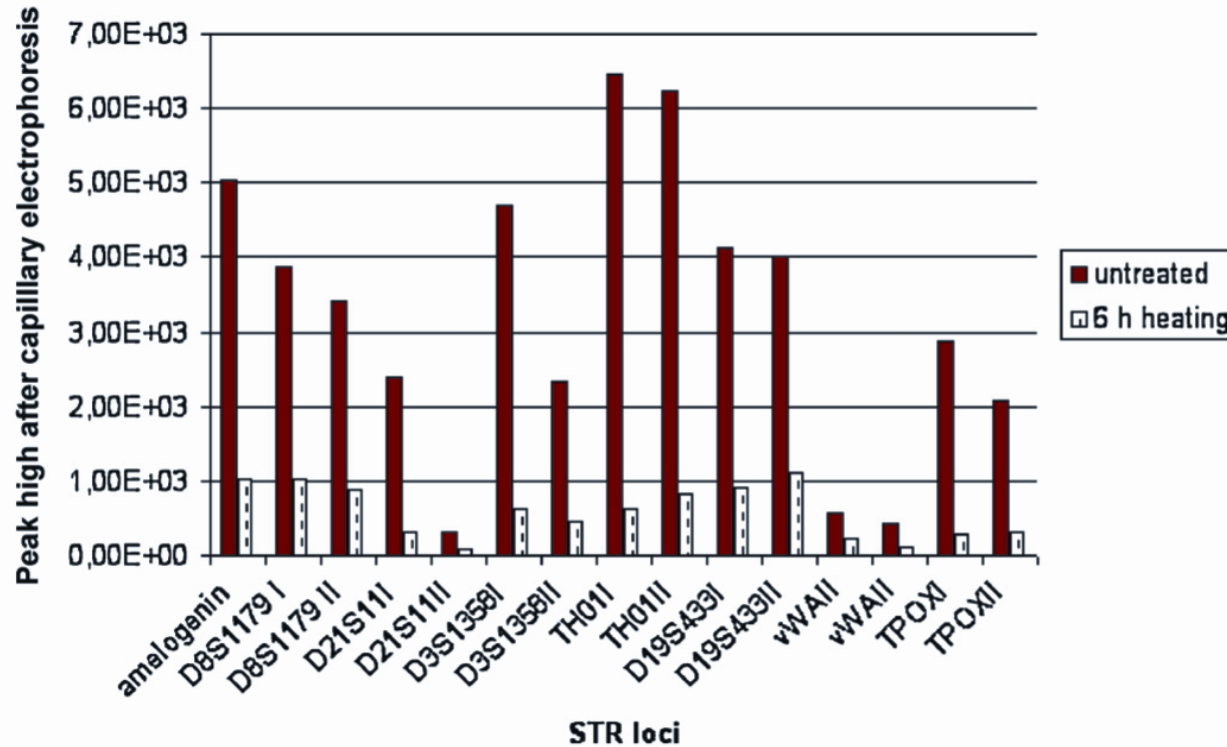


Fig. 6. DNA degradation after artificial heating procedure. The figure shows exemplarily the decrease of the specific STR fragments, D19S433, vWA, and TPOX from untreated (panel a) to 6 h heated samples (panel b) after Identifiler PCR amplification and capillary electrophoresis in an ABIPrism 310. (c) Gives an overview on average decrease of signal intensity (given in relative fluorescence units of peak high) of several STR loci showing the approximate 75% decrease of signal strengths after 6 h of heating procedure.

Depurinace

(hydrolýza)

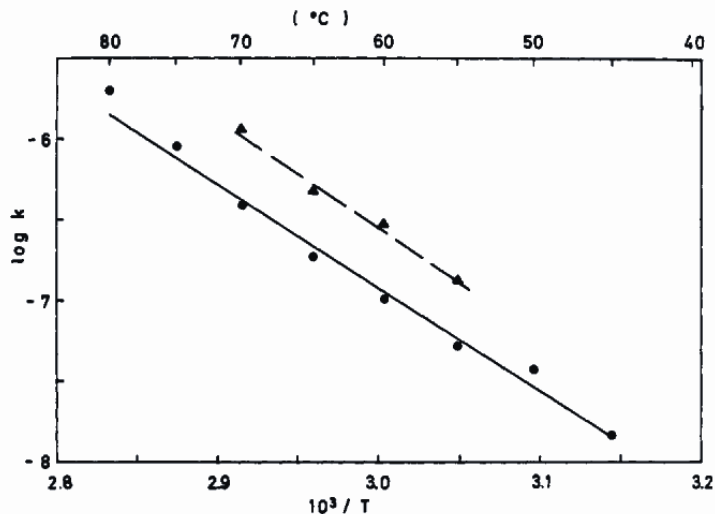


FIGURE 8: Arrhenius plot. Rate (sec^{-1}) of depurination of *B. subtilis* [^{14}C]DNA in buffer A (pH 5.0) as a function of temperature. (●) Native DNA; (▲) denatured DNA.

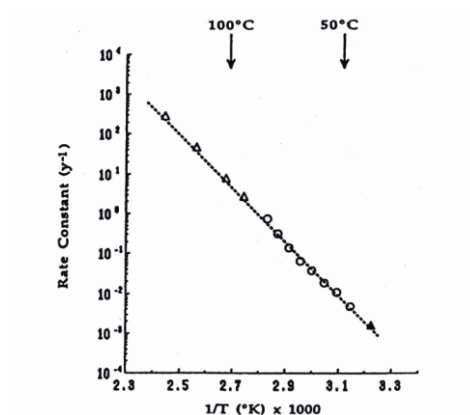


FIGURE 3. Rate of depurination of native DNA and rate of aspartic acid racemization as a function of $1/K$ (K) at physiological pH: Δ , measured rate of aspartic acid racemization; \circ , rate of DNA depurination; \blacktriangle , in vivo rate of aspartic acid racemization. (Reprinted with permission from ref 22. Copyright 1994 Elsevier Science.)

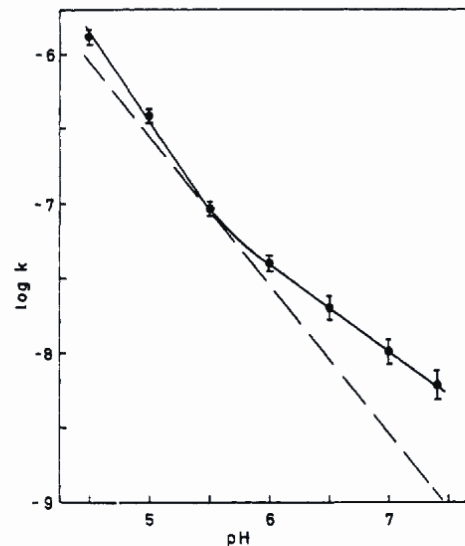
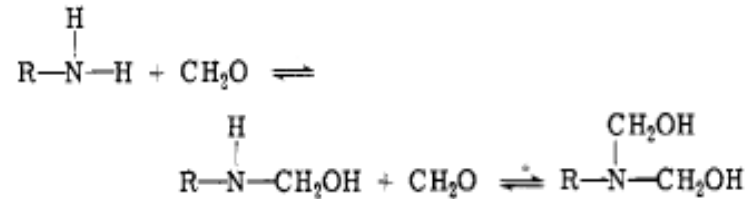
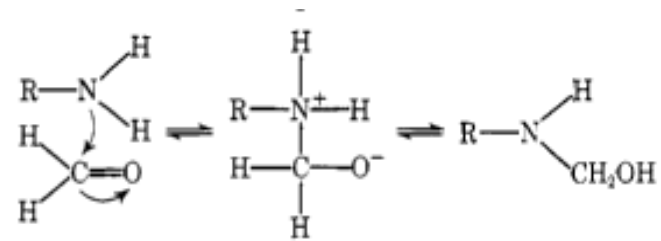
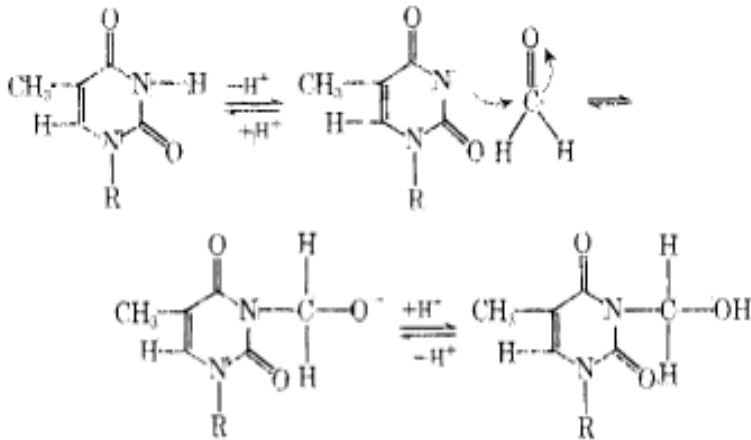


FIGURE 9: pH dependence of the rate of depurination of native *B. subtilis* [^{14}C]DNA in buffer A at 70° . The dashed line is the one expected for specific acid-catalyzed hydrolysis, using the rate constant obtained at pH 5.5 as a reference point.

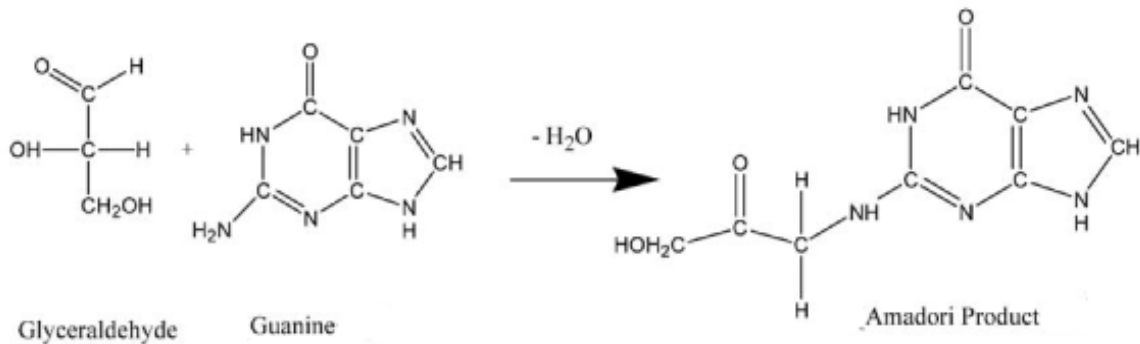
Reakce DNA s formaldehydem

Reakcí volné aminoskupiny nukleotidu (např. guaninu) s formaldehydem vzniká Schiffova báze. Tato reakce se uplatňuje při konzervaci anatomických preparátů formalínem (35-40 % vodný roztok formaldehydu).



Maillardova reakce DNA

Vazba aminoskupiny DNA v koprolitech býložravců na aldehydovou skupinu sacharidů v koprolitu.



Činidlo na uvolnění DNA z koprolitu

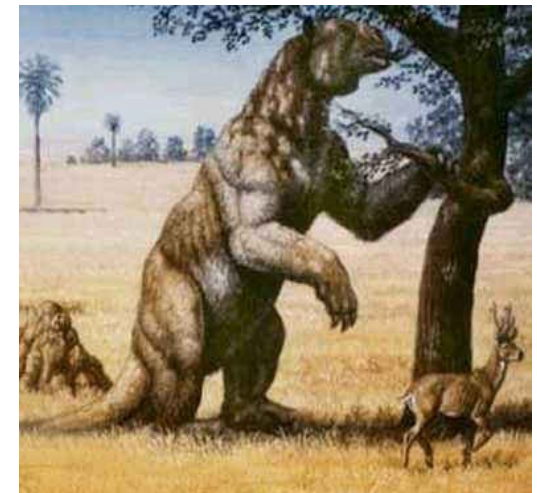
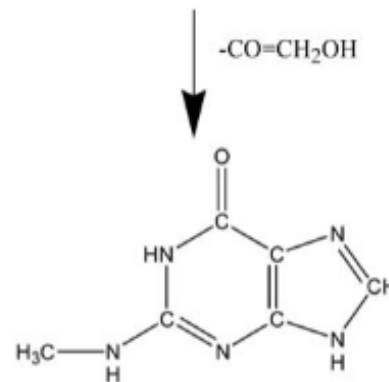
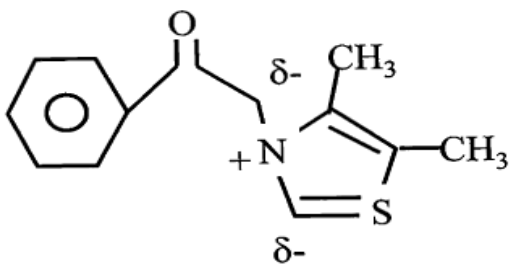
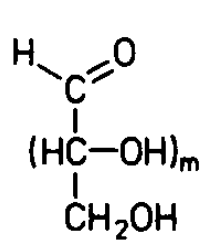
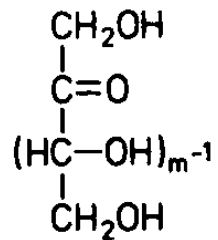


Fig. 1. The structure of N-phenacyl-4,5-dimethylthiazolium bromide (DMPTB).

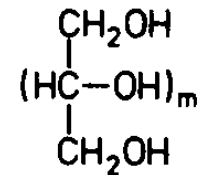
Sacharidy



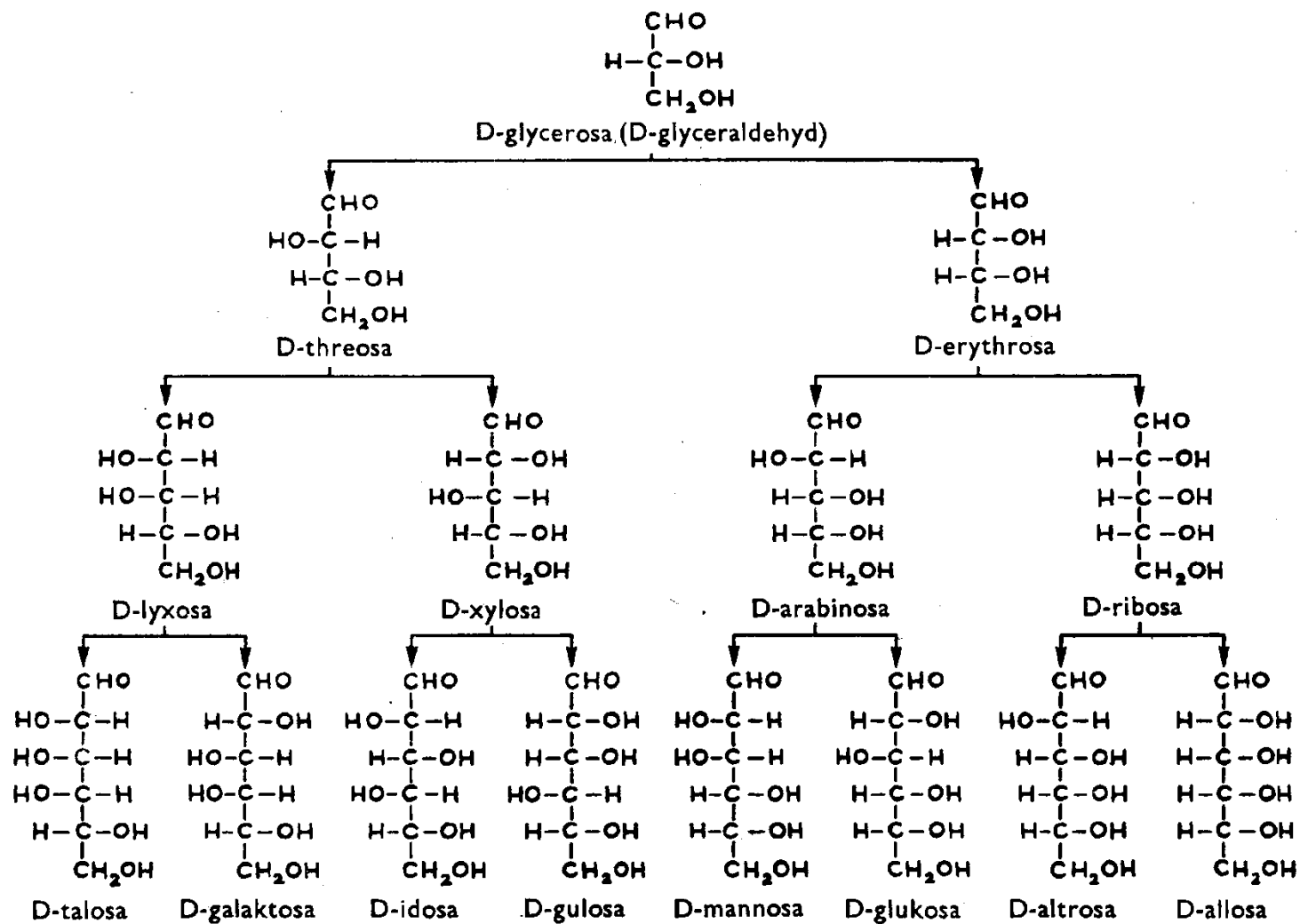
Aldose
Polyhydroxyaldehyd



Ketose
Polyhydroxyketon

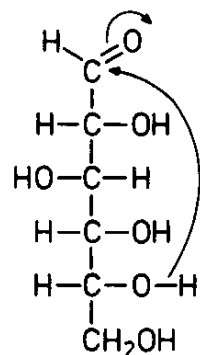


Polyol
Polyalkohol

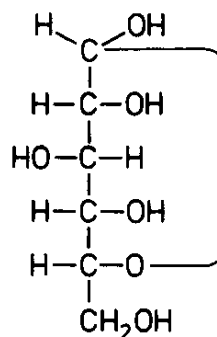
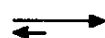


Obr. 1-3. Strukturní vztahy mezi aldosaми řady D.

Sacharidy



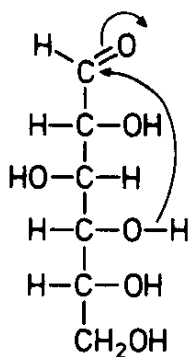
D-Glucose



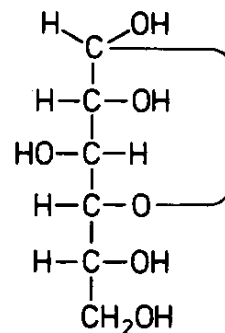
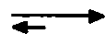
D-Glucopyranose



Tetrahydropyran



D-Glucose



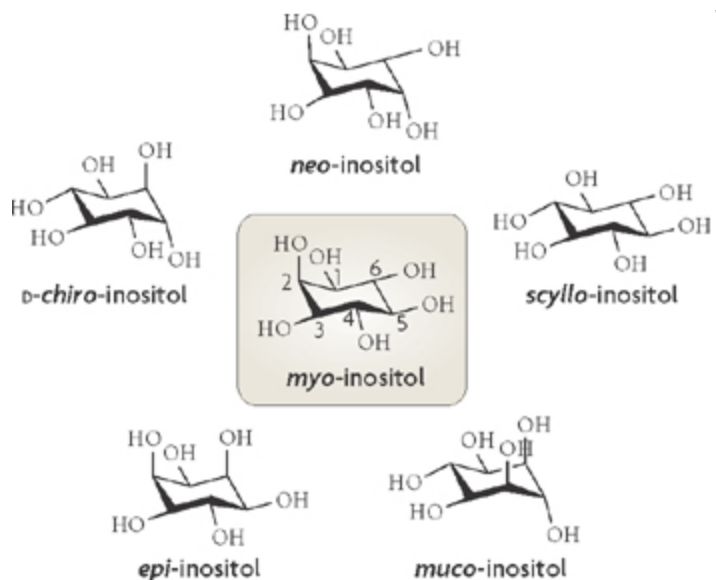
D-Glucofuranose



Tetrahydrofuran

Cyklitoly a fytoová kyselina

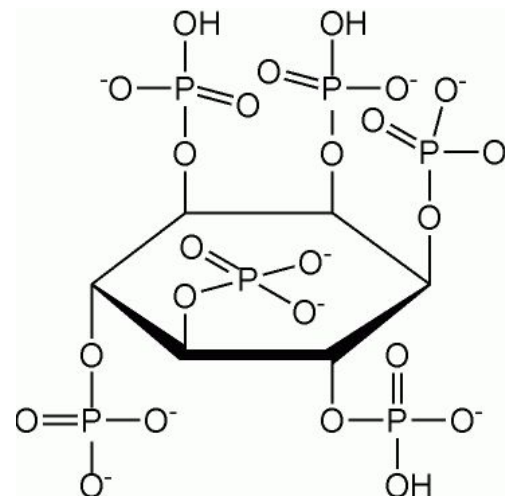
Inositol



Nature Reviews | [Molecular Cell Biology](#)

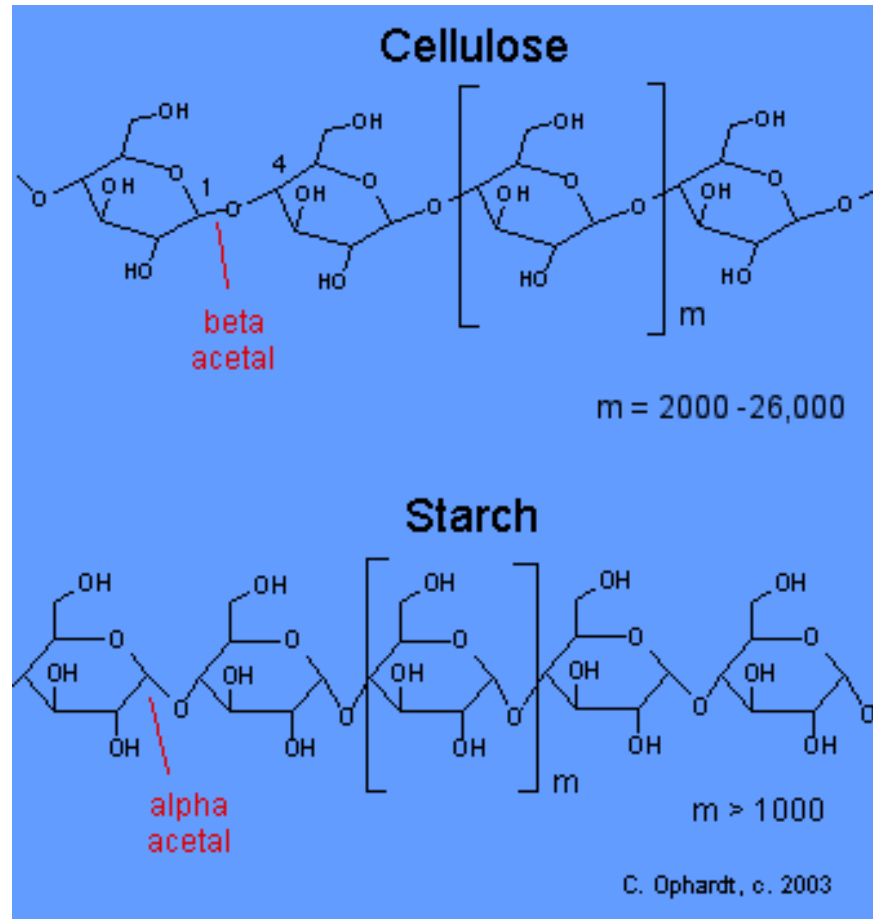
Cyklitoly jsou obsaženy např. v medu.

Kyselina fytoová
(ester inositolu s kyselinou fosforečnou)



Soli fytoové kyseliny jsou obsaženy v obilovinách a luštěninách

Polysacharidy



Přírodní gummy a klovatiny



Arabská guma

Z poraněné kůry stromů rodu *Accacia*
(*A. arabica*, *A. senegali*).

Pojivové a emulgační vlastnosti
Slabě nažloutlá, rozpustná ve vodě.

Lepidlo (na papír), příprava akvarelů a temper,
ochranný koloid.



Gumy ovocných stromů

Peckoviny:

třešeň,
višeň,
švestka,
meruňka, ...

Vlastnosti podobné arabské gumě, poskytuje roztoky s vyšší viskozitou, případně pouze botná.

Tmavší zbarvení – nevhodné pro světlé pigmenty.



Tragant

Keře rodu *Astragalus* (Írán, Sýrie, Turecko)

Ve vodě se nerozpouští, pouze botná (gel).

Příprava pastelů.



Carob

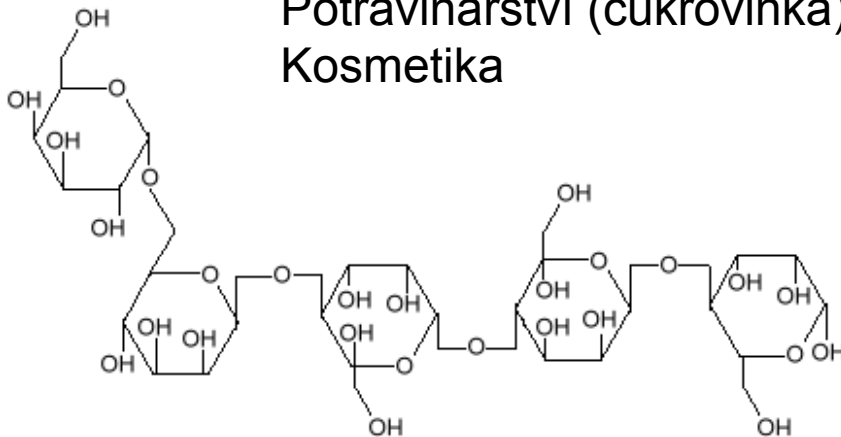
Ceratonia siliqua („svatojánský chléb“)

Svatojakubská guma se získává z endospermu semen rohovníku *Ceratonia siliqua*, který roste ve Středomoří.



Mumifikace (Egypt)

Potravinářství (cukrovinka)
Kosmetika



Karaya guma (indický tragant)

Guma Karaya je produkt ze *Sterculia urens*. Používá se jako zahušťovadlo, eulgátor a projímadlo v potravinách a jako lepidlo na zubní náhrady. Používá se také k falšování tragantové gummy vzhledem k jejich podobným fyzikálním vlastnostem.

Polysacharidy jsou částečně acetylovány.

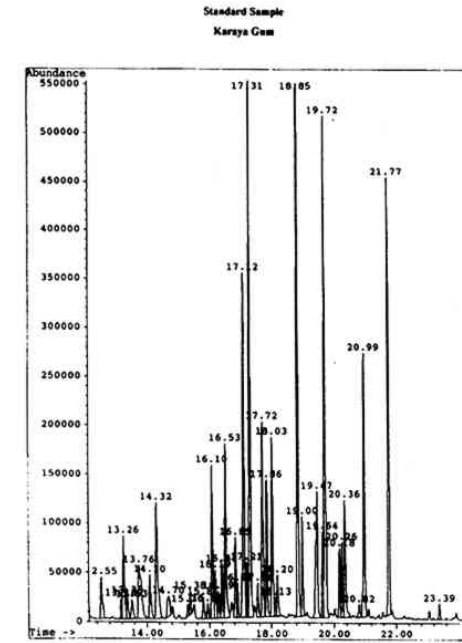
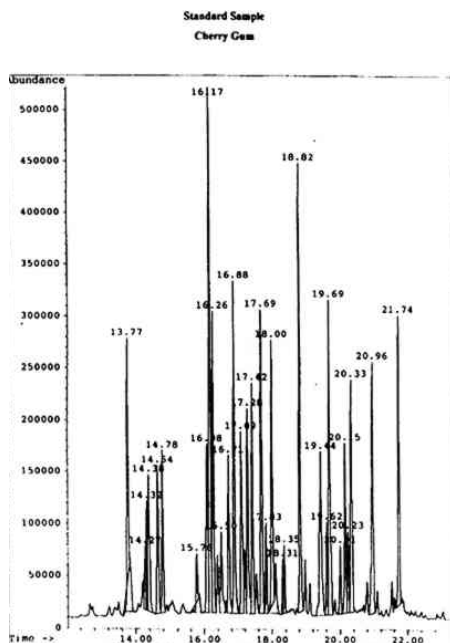
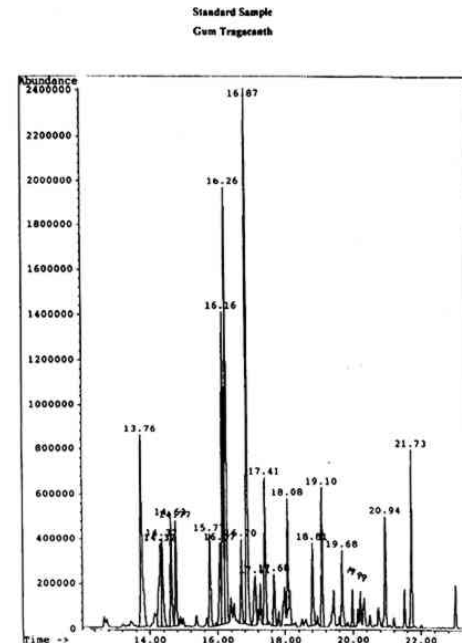
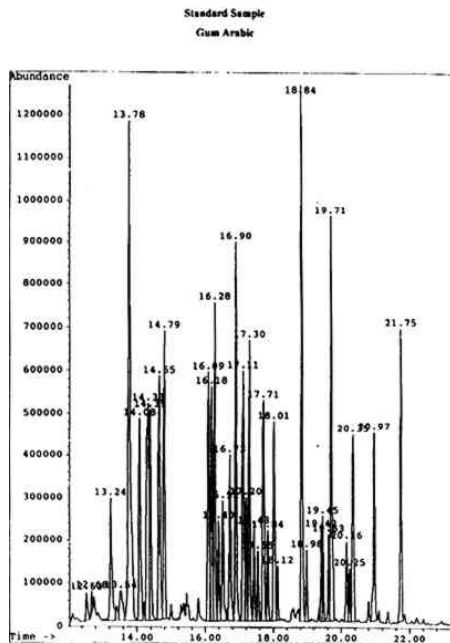




William Blake, *The Ghost of a Flea*, 1819–20.

Chromatogramy standardních gum:

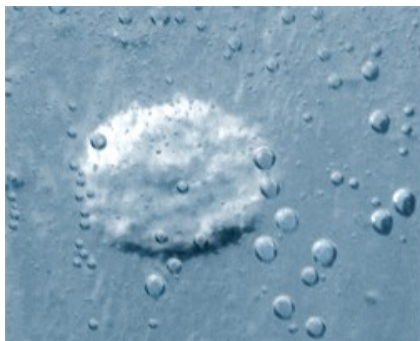
arabská guma,
tragantová guma,
třešňová guma,
guma karaya



Tamarindová guma

Tamarindus indica (Indie, JV Asie)

Nástěnné malby a miniatury
Potravinářství



Ghatti (Indian) guma

Guma Ghatti je amorfní průsvitný exudát stromu *Anogeissus latifolia* z čeledi Combretaceae.



Mesquitová guma (Chúcata)

Produkt stromů mesquite, místně známý jako Chúcata, je komerčně známý jako Mesquitová guma. Okrajově dostává název Algarrobo guma, ačkoli tento název se často používá v souvislosti s těmi, které produkují jihoamerické druhy *P. flexuosa* a *P. chilensis* pocházející z Argentiny a Chile. Mesquitové gumy se tedy obecně vztahují na výrobky z *Prosopis* spp. původem z Mexika.



Cholla gum

Produkt rostliny *Opuntia fulgida*

Obsahuje L-arabinózu (51,6 %), D-galaktózu (31,7 %), D-xylózu (15,0 %), L-rhamnózu (2-3 %) a kyselinu D-galakturonovou (11,2 %).



Opuntia fulgida (Nopal)

Khaya gum

Produkt rostliny *Khaya grandifolia*

Z Afrika

Potravinářství, farmacie

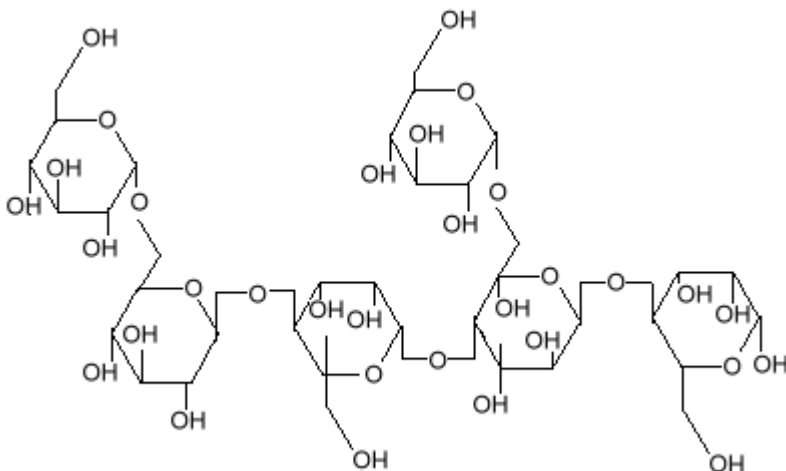


Guarová guma

Guma guar pochází z endospermu semen luštěniny *Cyamopsis tetragonolobus*. *Cyamopsis tetragonolobus* je jednoletá rostlina pěstovaná v suchých oblastech Indie jako krmná plodina pro zvířata.

Kosmetika, potravinářství (cukrovinky)

Galaktomannan (alfa-D-galaktózové a alfa-D-mannozové jednotky)



Tabulka 11 Složení polysacharidů³⁹

Monosacharid	Arabská guma	Tragant	Třešňová guma	Švestková guma	Broskvová guma
	(%)				
kys. glukuronová	16	–	12	15	7
kys. galakturonová	–	43	–	–	–
arabinosa	19	3	55	34	43
galaktosa	52	4	21	40	36
rhamnosa	14	–	stopy	–	stopy
xylosa	–	40	–	11	14
manosa	–	–	10	–	–
fukosa	–	10	–	–	–

Table 6.1 Sugar and uronic acid components of some gums and mucilages

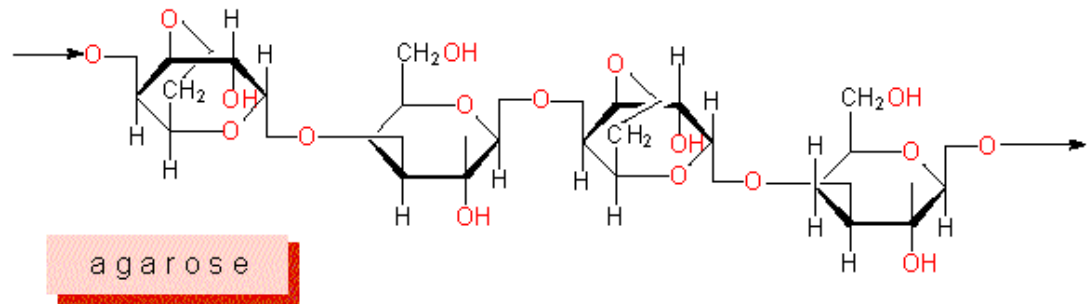
	<i>Arabinose</i>	<i>Rhamnose</i>	<i>Galactose</i>	<i>Glucose</i>	<i>Mannose</i>	<i>Xylose</i>	<i>Fucose*</i>	<i>Glucuronic acid</i>	<i>Galacturonic acid</i>
Gum arabic	++	+	++					+	+
Tragacanth	+		+			+	+		+
Cherry gum	++		+		+	+		+	
Guar gum			+		++				
Carob or locust bean									
Tamarind seed gum			+		++				
Karaya gum	+		+	+		+			++
Ghatti gum	++		++		+	+		+	
Cholla gum	+	+	+						+
Olibanum	+		+					+	
Myrrh	+		+					+	
								(4-O-methyl-)	
								+	
								(4-O-methyl-)	

* 6-deoxy-L-galactose.

+ indicates that the sugar is present; ++ indicates a major component

Mikrobiální slizy: agar

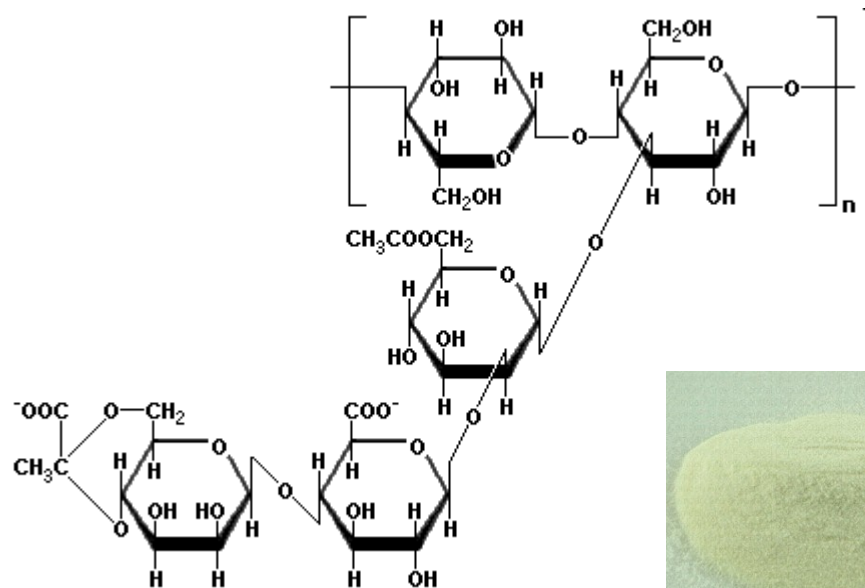
Gloiopeltis furcata (mořská tráva)



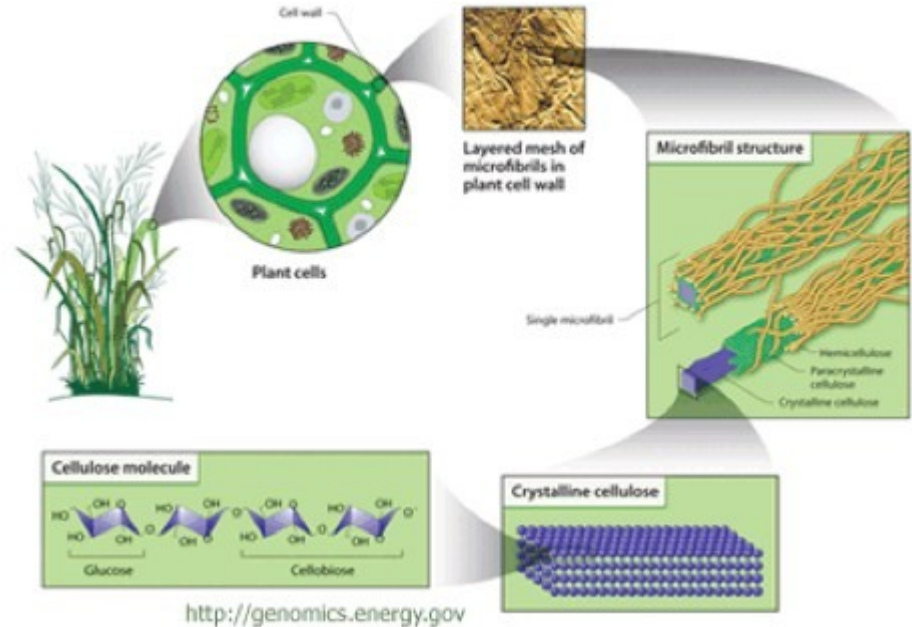
Agar (jinak též agar-agar) je přírodní polysacharid (lineární polymer galaktózy) s vysokou gelující schopností, který se vyrábí z červených mořských řas rodu Floridae. Používá se jako živné médium pro kultivaci mikroorganismů a rostlin. Taje při +96 °C a tuhne při +40 °C.

Xanthanová guma

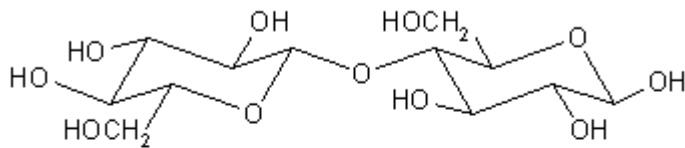
- slizovitý gel produkovaný bakterií *Xanthomonas campestris*, která způsobuje černou hnilobu na brukvovité zelenině, jako je květák a brokolice. Sliz chrání bakterii před viry a zabraňuje jejímu vysychání.



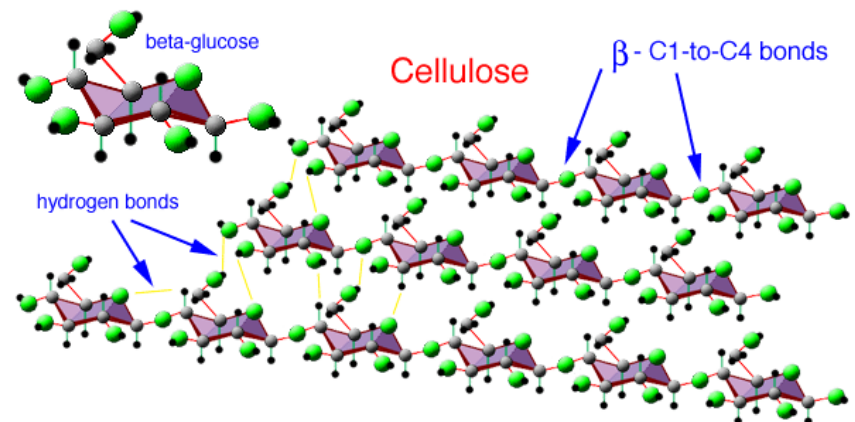
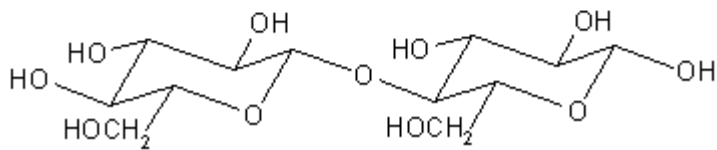
Celulóza



cellobiose dimer (two glucose units in cellulose)



maltose dimer (two glucose units in starch)



Deriváty celulózy

Xanthát celulózy (celofán) = reakce celulózy s NaOH a CS₂, poté se sráží v kyselém lázni. Používá se jako obalový materiál; nízká pevnost, křehkost.

Nitrát celulózy. Výroba nitrolaků (žloutnou) a lepidel (např. na keramiku). Rozpustný v acetonu, esterech a směs ether + alkohol.

Acetát celulózy. Výroba fólií (jako měkčidla se používají ftaláty), transparentních laků a lepidel. Rozpustný v acetonu, dichlormethanu, methanolu a směsi aceton + alkohol.

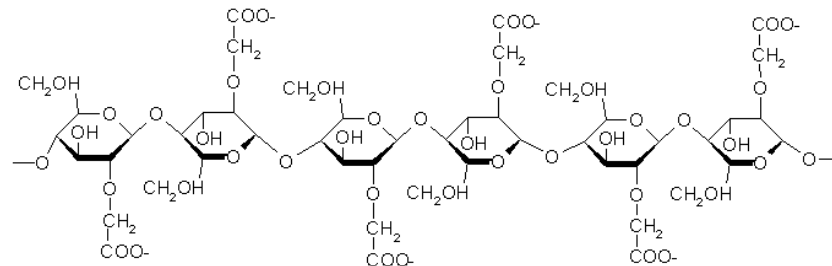
Acetobutyráť celulózy. Výroba laků a fólií (konzervace papíru). Rozpustný v acetonu, esterech, směsi toluen + ethanol (80/20).

Deriváty celulózy

Methylcelulóza. Lepidlo, pojivo barev, zahušťovadlo a ochranný koloid. Rozpustná ve studené vodě, vylučuje se z roztoku solí a horké vody.

Karboxymethylcelulóza. Sodná sůl kyseliny celulosoglykolové, viskozita se liší podle polymeračního stupně. Je anioaktivní a hydrofilní, nerozpustná v organických rozpouštědlech. Rozpouští se ve vodě a vodných roztocích methanolu, ethanolu a glycerinu. Pojivo a lepidlo papíru, zahušťovadlo vodných disperzí polymerů. Mikrobiální degradace.

Hydroxyethylcelulóza. Reakcí ethylenoxidu s OH skupinami celulózy, vznikají polyethylenoxidové řetězce. Má neionogenní charakter. Ochranný koloid, zahušťovadlo vodných disperzí polymerů, lepidlo na papír. Mikrobiální degradace.



Celuloid

Typický celuloid obsahuje přibližně 70–80 dílů nitrocelulózy (s 11% obsahem dusíku), 30 dílů kafru, 0 až 14 dílů barviva, 1 až 5 dílů etanolu a malé množství různých stabilizátorů a přísad, které činí celuloid trvalivějším a méně hořlavým.

Celuloid je vysoce hořlavý a časem křehne, proto se už nevyužívá v tak velkém množství jako v minulosti. Zvětrávání celuloidu je velký problém při archivaci starých fotografických filmů.



Vel. Británie

1856 A. Parkes („parkesin“)

1869 D. Spill („xylolit“)

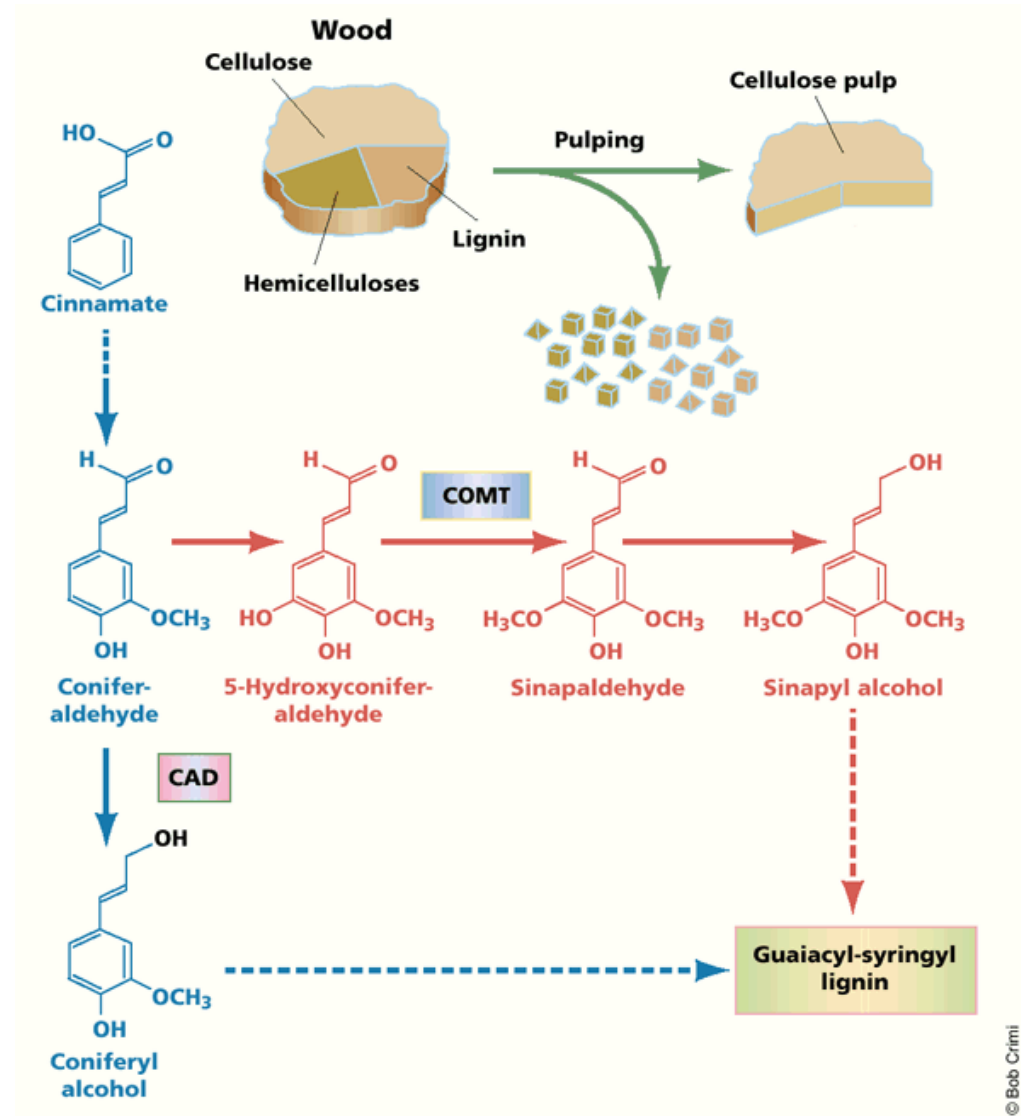
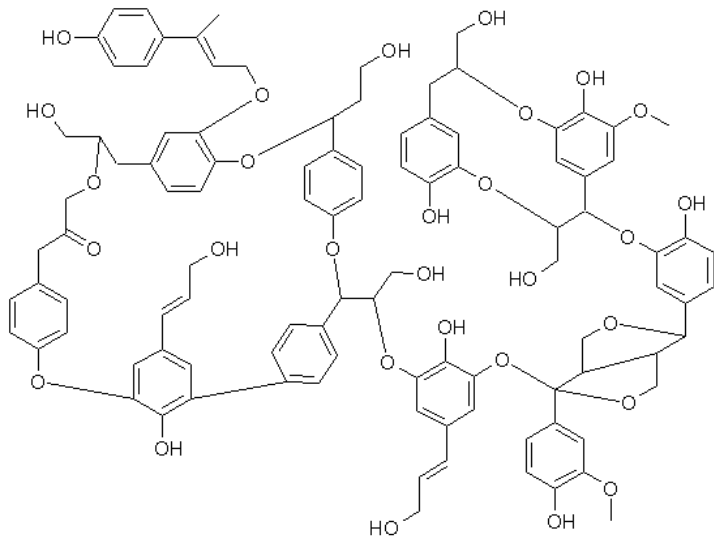
USA

60. Léta 19. stol. J. W. Hyatt
(od 1870 „Celuloid“)

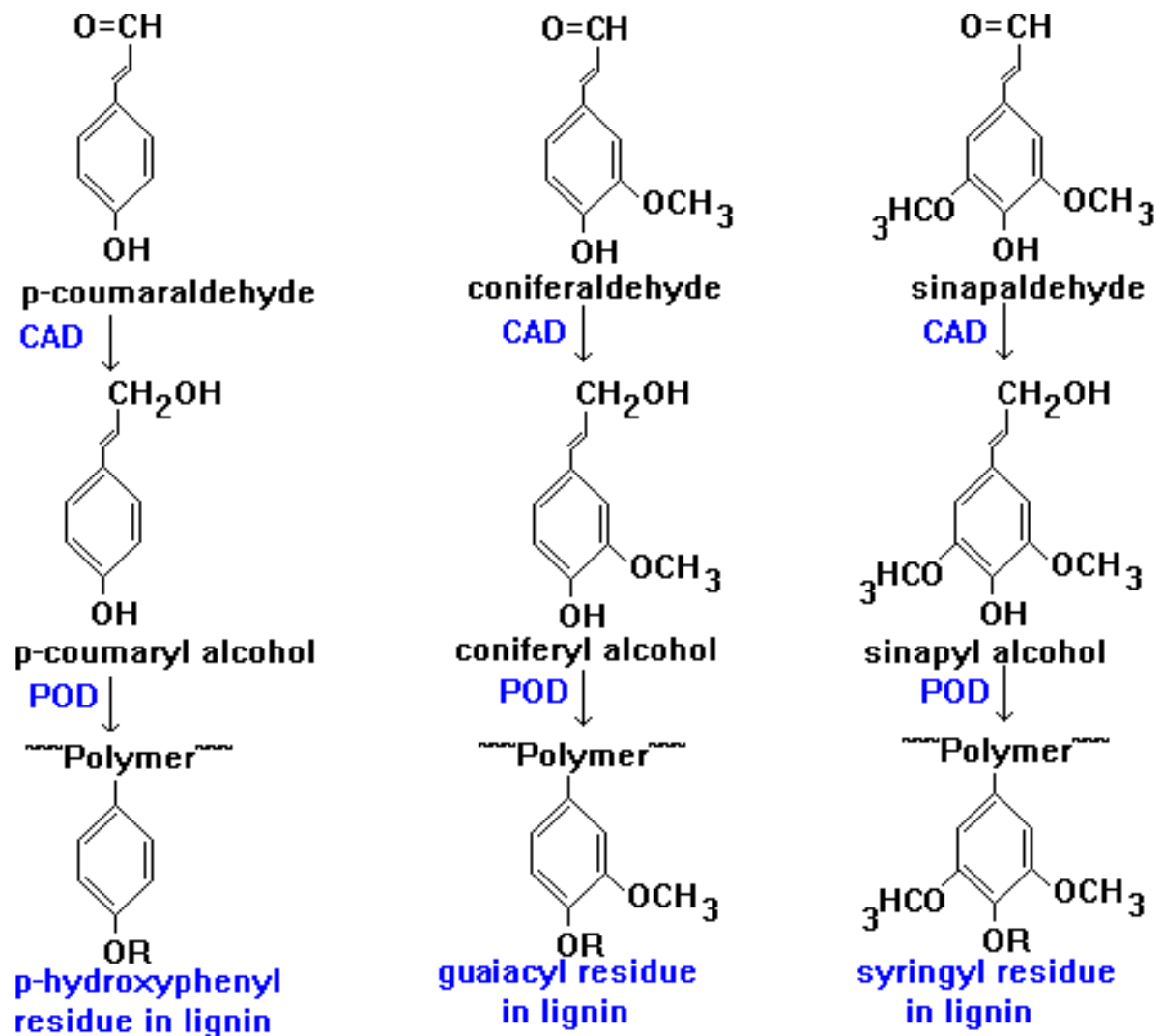


Lignin

Lignin je složkou dřeva zabezpečující dřevnatění jeho buněčných stěn. Je to vysokomolekulární polyfenolická amorfní látka.



Lignin



Rostlinná vlákna

- ***Bavlna*** (semena bavlníku)
- ***Len*** (stonky lnu)
- ***Konopí*** (stonky konopí)
- ***Kopřiva*** (stonky kopřivy)



Ostatní rostlinné materiály

Juta (stonky jutovníku, *Corchorus capsularis*) – J a JV Asie, J Amerika

Kapok (tobolky, rod *Bombaceae*) – J Asie, V Afrika, J Amerika

Ramie (stonky čínské trávy, *Boehmeria*) – JV a V Asie

Kenaf (stonky ibišku konopného, *Hibiscus cannabinus*) – JV Asie

Sunn (stonky bengálského konopí, *Crotolaris juncea*) – J Asie

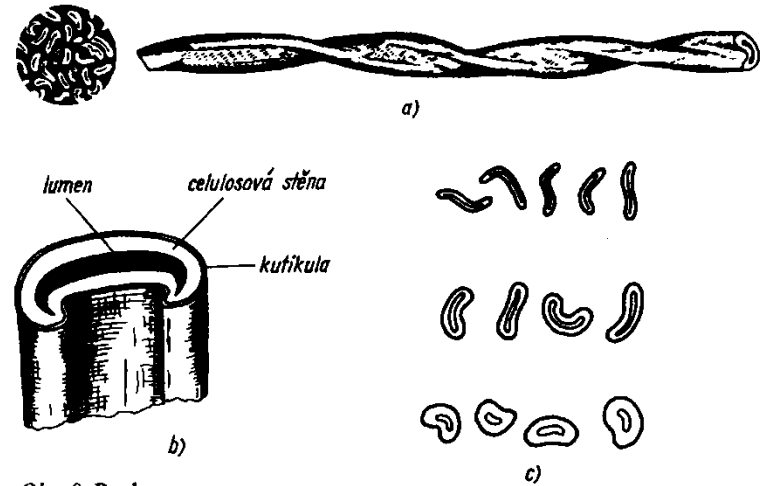
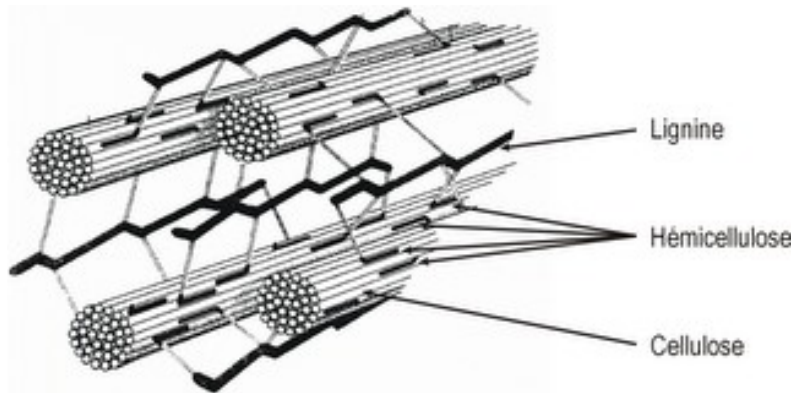
Sisal (listy, *Agave sisaliana*) – J Amerika, Afrika, Asie

Novozélandský len (listy, *Phormium tenax*)

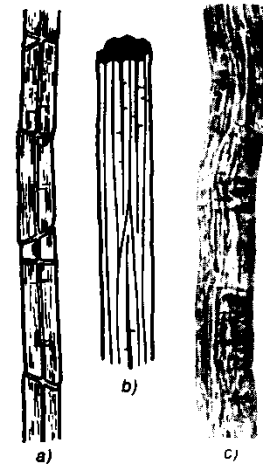
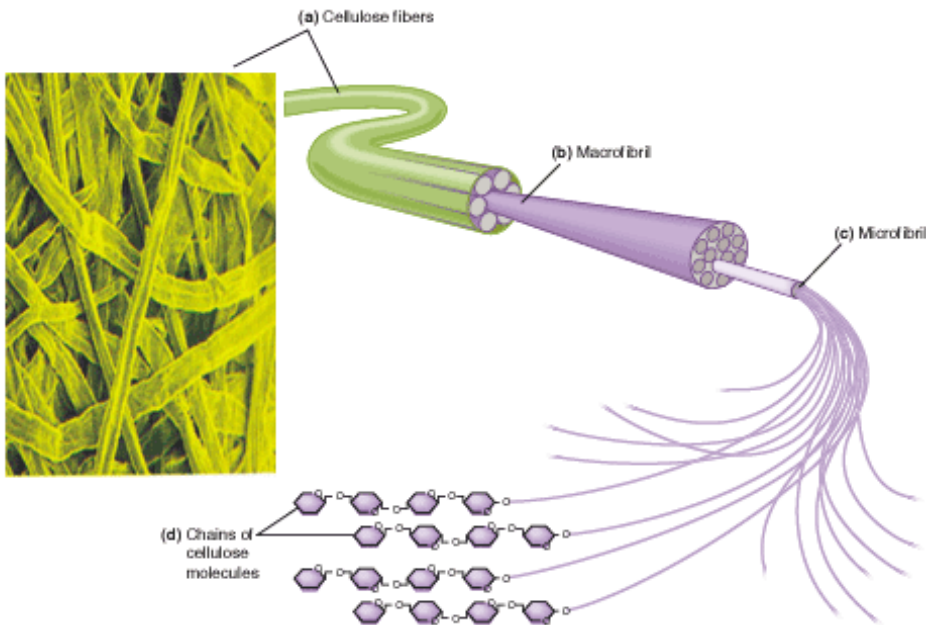
Abaka (listy *manilského konopí*, *Mussa textilis*) – Filipíny, Indonésie, Indie

Kokosová vlákna (plody, *Cocos nucifera*) – Sri Lanka

Rostlinná vlákna



Obr. 9. Bavlna
a – vlákno bavlny, b – řez vláknem, c – tvary vláken v průřezu



Obr. 16. Vlákno lnu
a – kolénka (schematicky), b – štěpitelný svazek technického vlákna (schematicky), c – snímek vlákna lnu

Chemie rostlinných vláken

- Celulóza

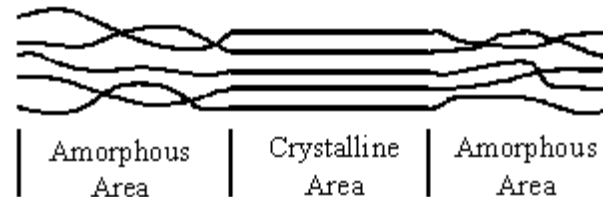
Bavlna (92% celulózy)

Len (81% celulózy)

Konopí (74% celulózy)

Juta (72% celulózy)

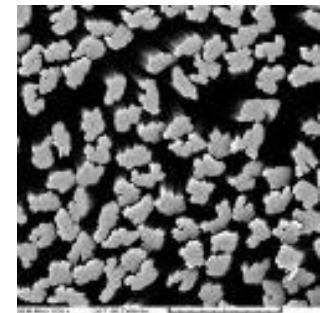
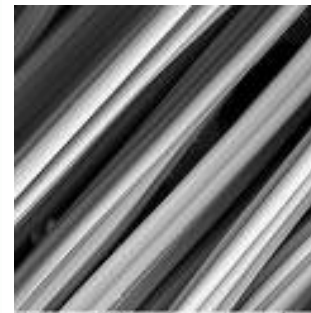
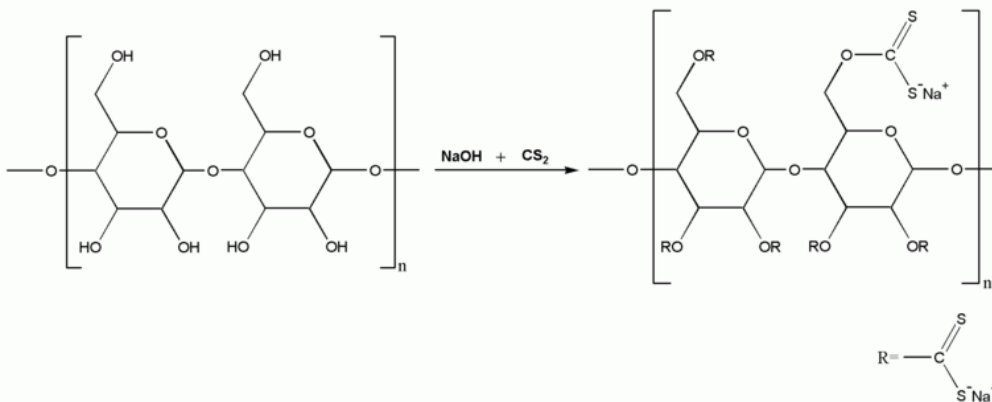
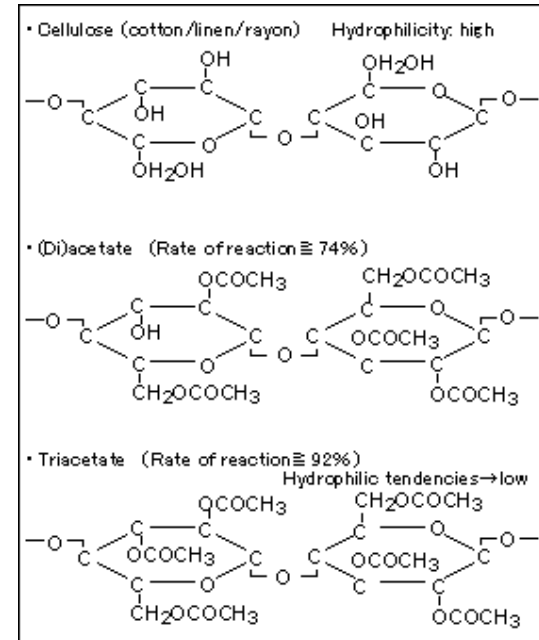
- Lignin



Upravená vlákna na bázi celulózy

(rayon)

- *Chardonetovo hedvábí (nitrocelulóza)*
- *Měďnaté (bemberské) hedvábí*
- *Acetátové hedvábí (acetát celulózy)*
- *Viskózové hedvábí (xanthát celulózy)*



Termická degradace celulózy

Do 100 C odolává, od 120 C se začíná rozkládat, 150 C vzniká pyrocelulóza a od 240 C plynné zplodiny hoření.

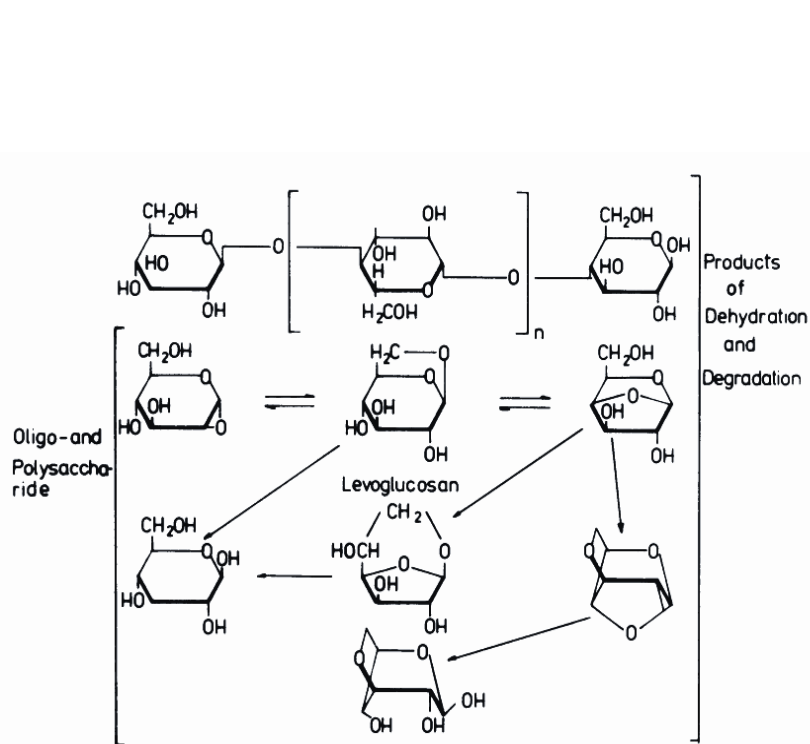
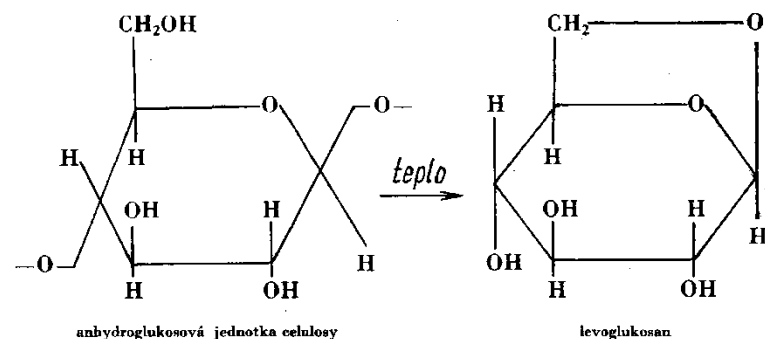
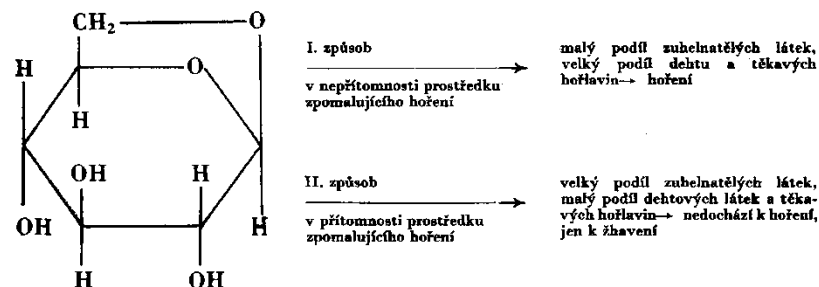


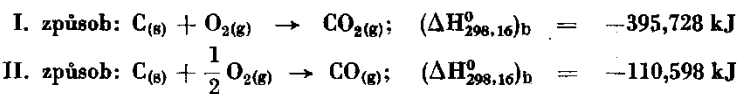
Fig. 1 Scheme of thermal degradation of cellulose.

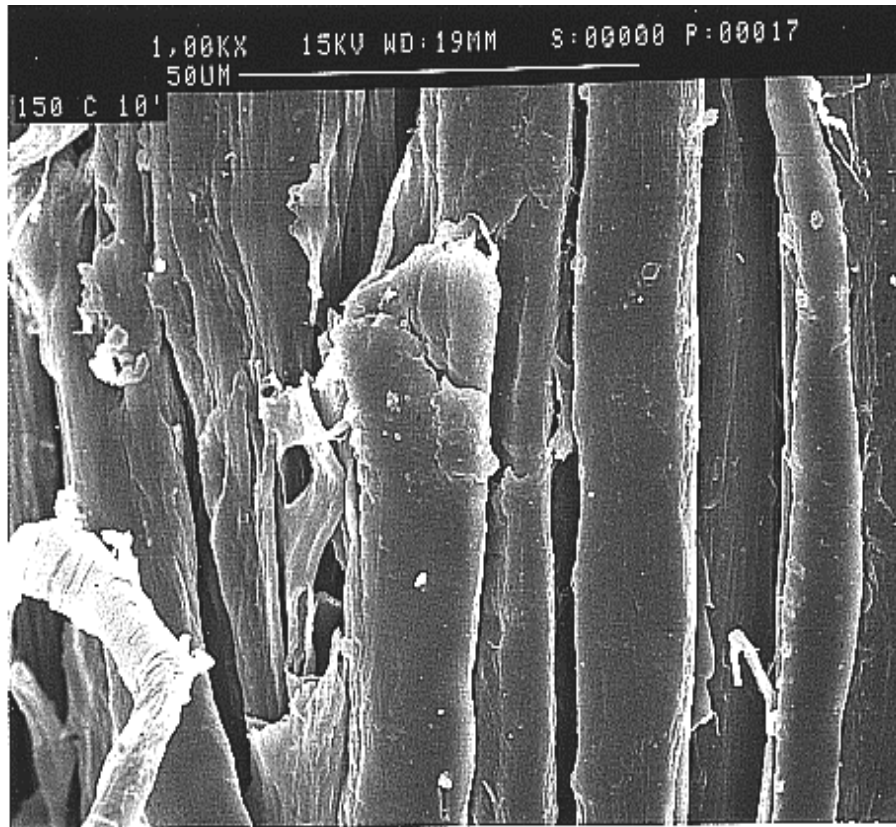


II. stadium — degradace levoglucosanu

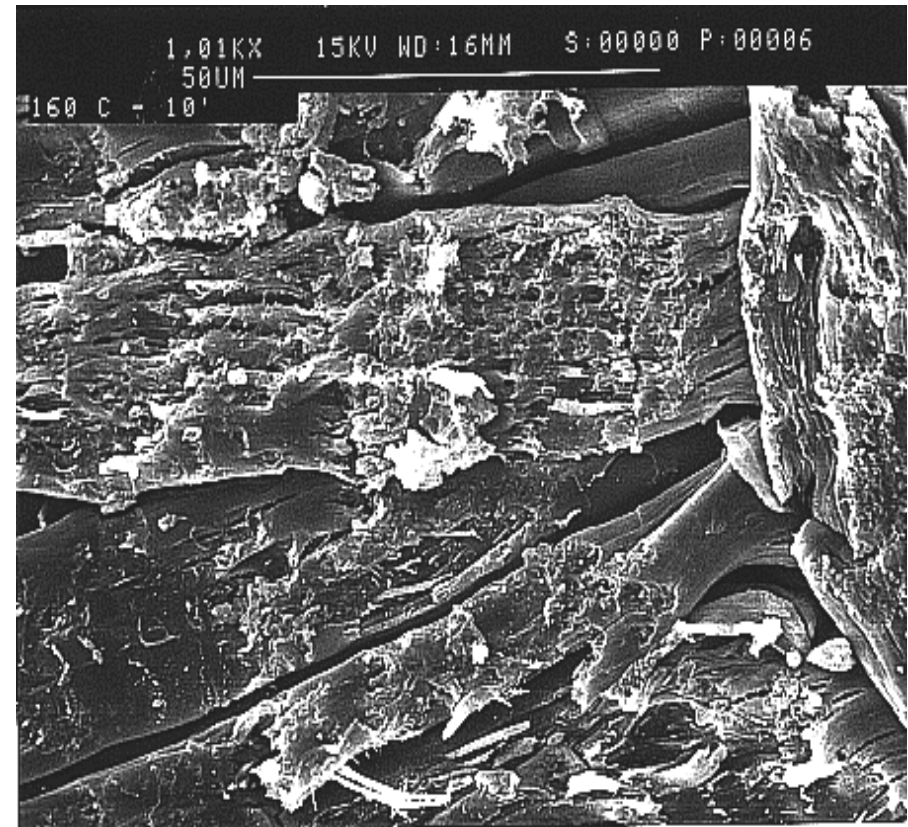


Tepelnou bilanci pomocí slučovacího tepla lze znázornit známými rovnicemi:





SEM Inu po působení teploty 150 C
po 10 min

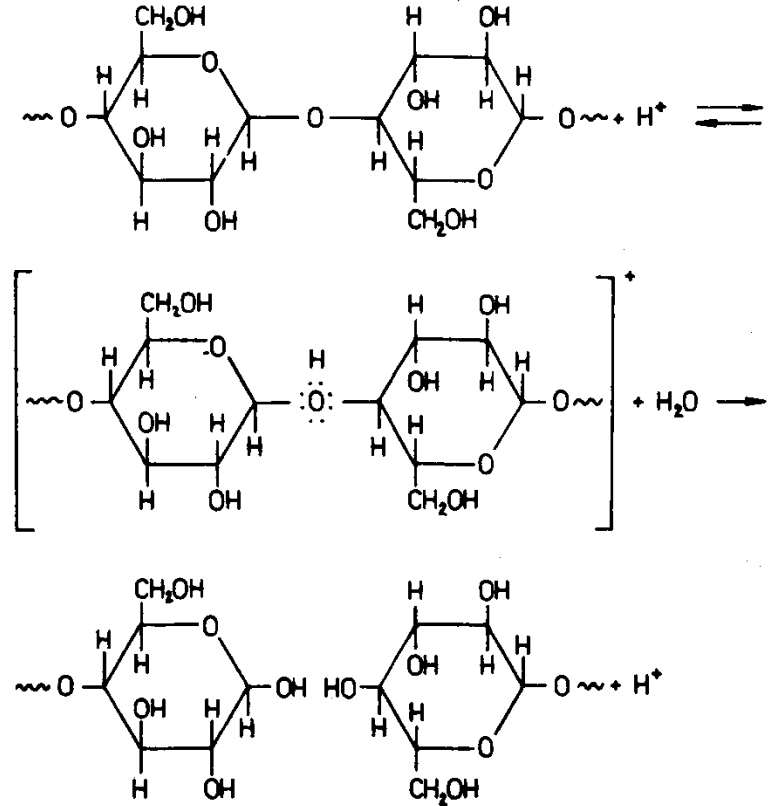


SEM Inu po působení teploty
160 C po 10 min (eroze povrchu
vláken).

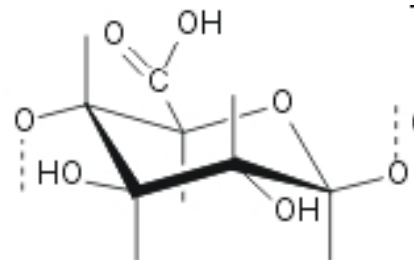
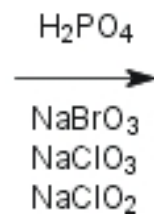
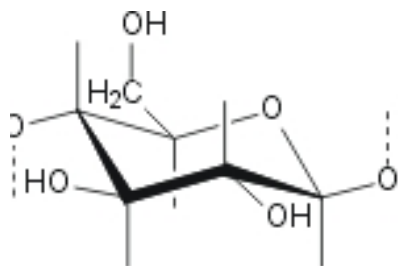
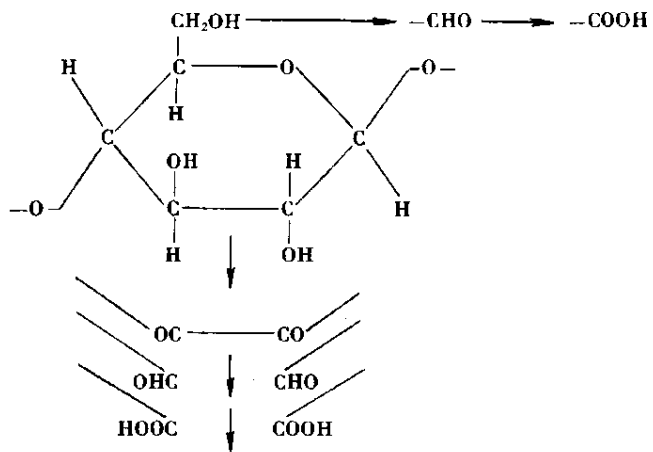
Kyselá hydrolýza

Citlivá vůči kyselinám, snadno se hydrolyzují, zejm. za horka. Citlivější jsou vlákna s menším podílem krystalické složky.

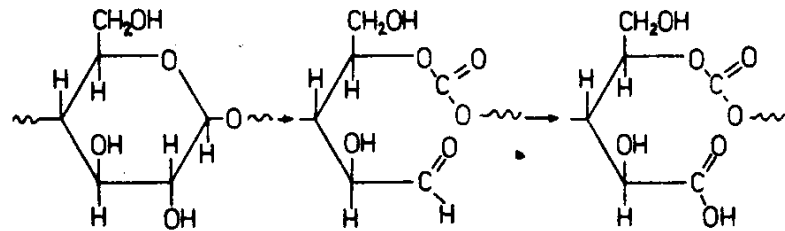
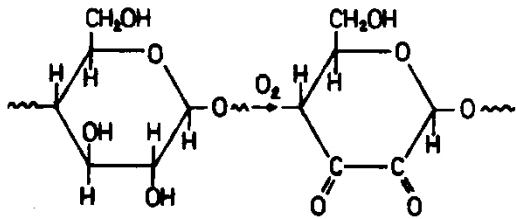
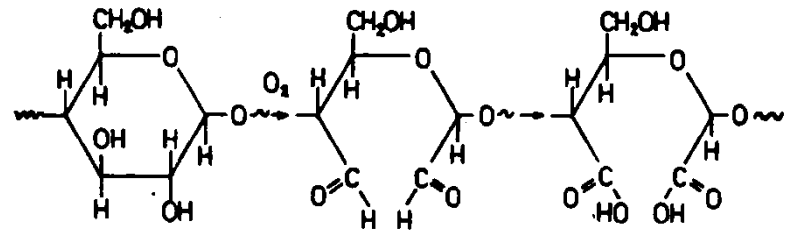
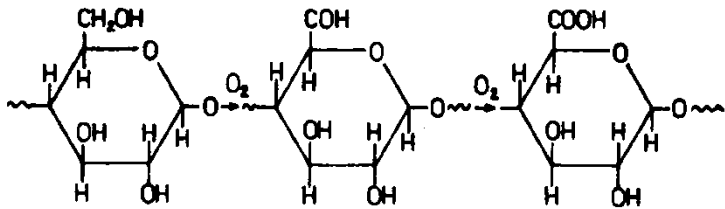
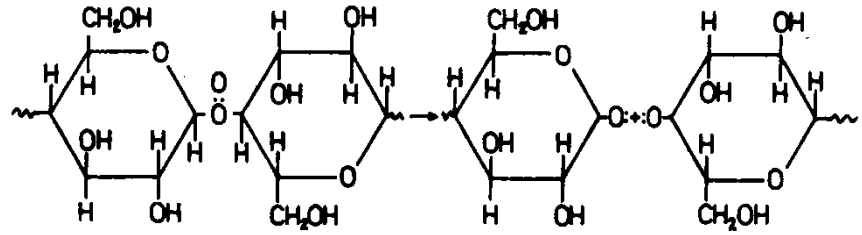
Odolávají působení alkálií X snadno se v alkalickém prostředí oxidují.



Oxidace



Oxidace



Mikrobiální degradace celulózy

Celulóza: enzymatická hydrolýza celulázami (bakterie, plísně)

Plísně

Chaetomium,
Myrothecium,
Memnoniella,
Stachybotrys,
Verticillium,
Alternaria,
Trichoderma,
Penicillium
Aspergillus

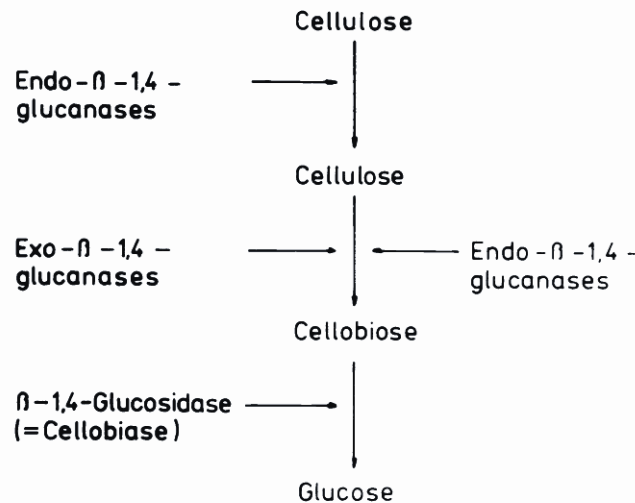


Fig. 3. Scheme of the enzymatic degradation of cellulose

Bakterie

Cytophaga,
Cellulomonas,
Cellvibrio,
Bacillus,
Clostridium
Sporocytophaga

Mikrobiální degradace celulózy

Faktory:

pH prostředí

Vlhkost

Přístup kyslíku

Rozsah pH a jeho optimum pro růst mikroorganismů

Druh mikroorganismu	rozmezí pH	optimum pH
<i>Bacillus thermofibrincolus</i>	3,4–11,7	8,0–8,4
<i>Bacterium protozoides</i>	5,0– 9,2	7,5
<i>Cellulobacillus varsaviensis</i>	5,8– 8,2	7,5–7,7
<i>Cellulomonas biazotea</i>	5,2– 6,9	6,4
<i>Clostridium cellobioparus</i>	4,0– 8,0	5,5
<i>Cytophaga hutchinsonii</i>	6,5– 9,0	7,5
<i>Sorangium compositum</i>	4,5– 9,5	8,0–8,5
<i>Spirochaeta cytophaga</i>	1,5–12,5	7,0–7,6
<i>Sporocytophaga cytophaga</i>	2,5– 9,5	7,5
<i>Vibrio napi</i>	4,6– 7,6	7,6
<i>Vibrio prima</i>	4,6– 9,2	7,5–7,6
<i>Actinomyces sp.</i>	2,5– 9,5	7,7
<i>Mycococcus cytophaga</i>		7,0

Rozsah pH a jeho optimum pro rozmnožování plísní, odbourávajících celulosu

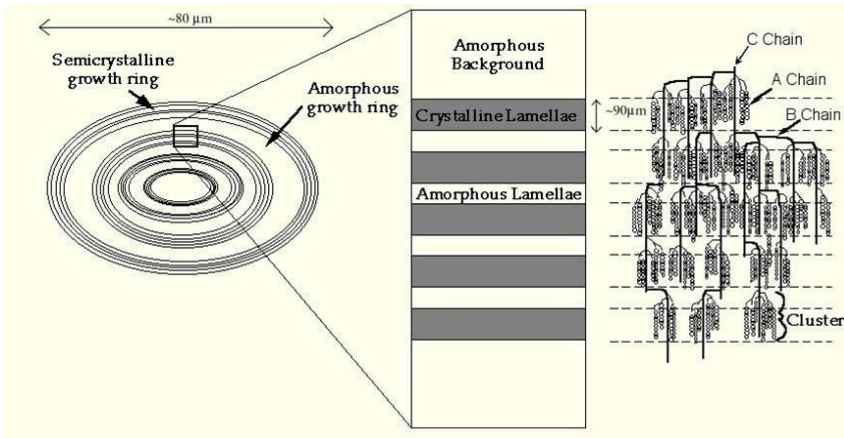
Druh mikroorganismu	rozmezí pH	optimum pH
<i>Aspergillus niger</i>	1,2	6,7–7,7
<i>Aspergillus flavipes</i>	2,5–9,0	6,5
<i>Aspergillus fumigatus</i>	3,0–8,0	5,6
<i>Sporotrichum carnis</i>	2,8–7,6	4,5
<i>Trichoderma koningi</i>	2,5–9,5	4,3
<i>Myrothecium varrucaria</i>	2,5–9,0	6,0
<i>Humicola grisea</i>	5,0–8,7	7,7
<i>Humicola sp.</i>	2,5–9,5	6,0
<i>Botryosporum sp.</i>	4,5–7,4	6,6–7,4
<i>Curvularia lunata</i>	2,5–9,0	7,0

Minimální relativní vlhkost vzduchu potřebná k růstu plísní

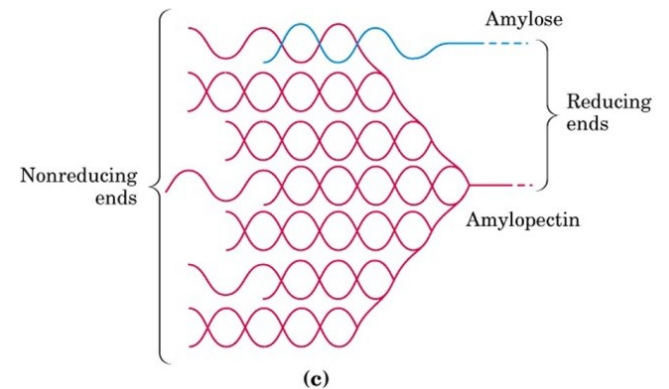
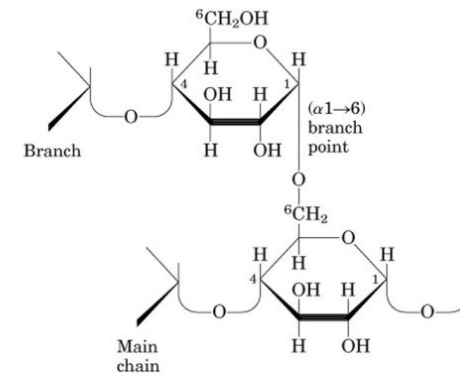
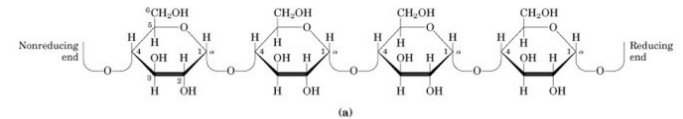
Druh mikroorganismu	relativní vlhkost v %	Druh mikroorganismu	relativní vlhkost v %
<i>Rhizopus nigricans</i>	93	<i>Aspergillus versicolor</i>	78
<i>Trichothecium roseum</i>	90	<i>Aspergillus candidus</i>	74
<i>Cladosporium herbarum</i>	88	<i>Aspergillus chevalieri</i>	72
<i>Penicillium rugulosum</i>	86	<i>Aspergillus repens</i>	71
<i>Aspergillus niger</i>	84	<i>Aspergillus ruber</i>	70
<i>Penicillium wortmanni</i>	81	<i>Aspergillus echinulatus</i>	63
<i>Penicillium fellutanum</i>	80		

Škrob

- Obilí, rýže, brambory



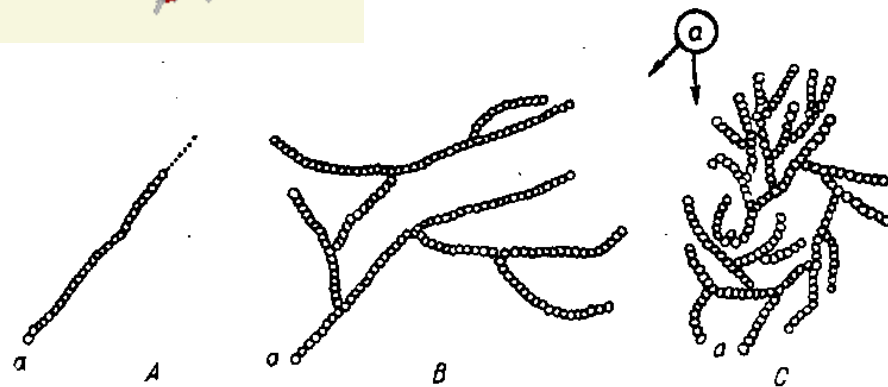
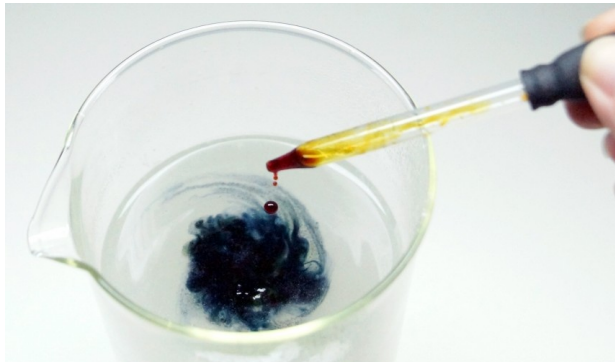
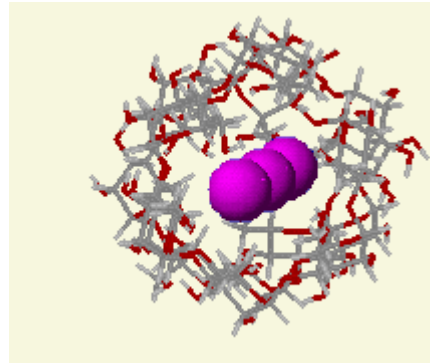
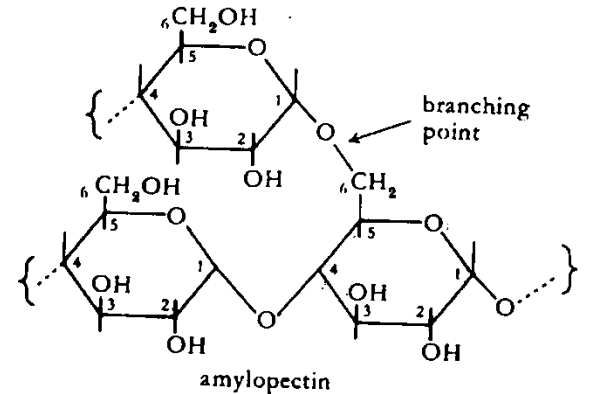
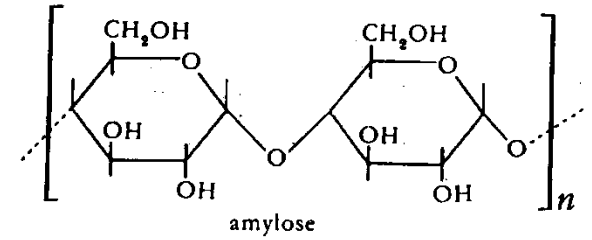
Starches, amylose & amylopectin



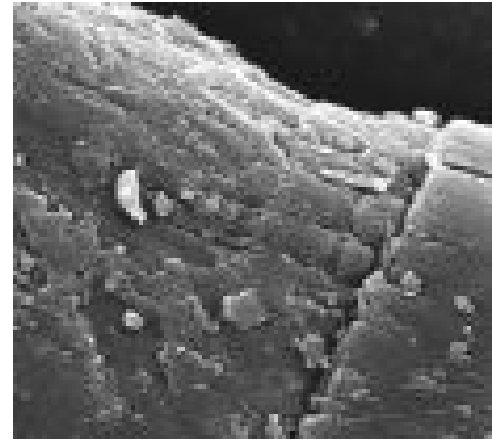
Škrob

- Amylóza
- Amylopektin

S jodem tvoří modře zbarvený komplex.



Obr. 67. Schematické znázornění stavby: amylosy (A), amylopektinu (B), glykogenu (C).
a - aldehydové koncové skupiny; kroužky jsou glukosové jednotky.



Chitin

Polysacharid na bázi aminocukrů;
hmyz, houby

Skládá se z N-acetyl-D-
glukosaminových jednotek, vázaných
beta(1-4) vazbami.

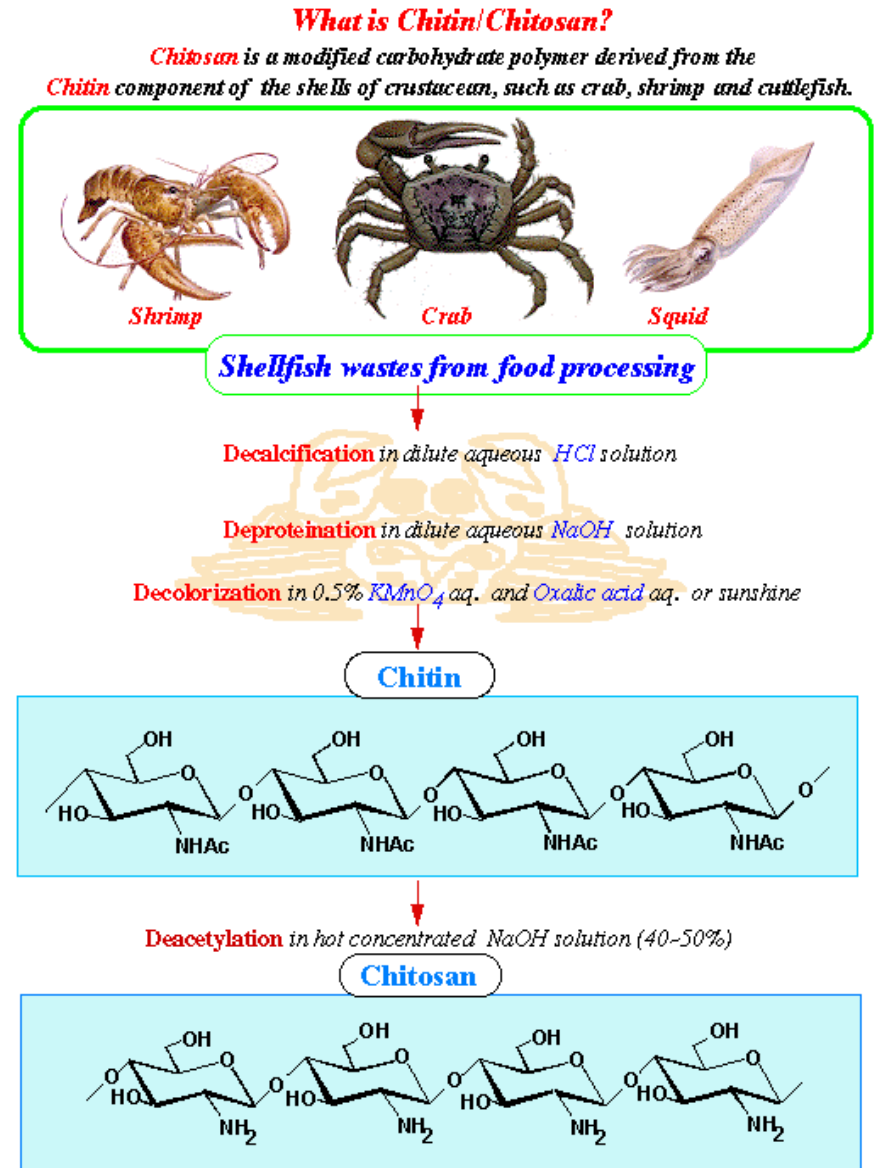


Fig. 2. Preparation of chitin and chitosan

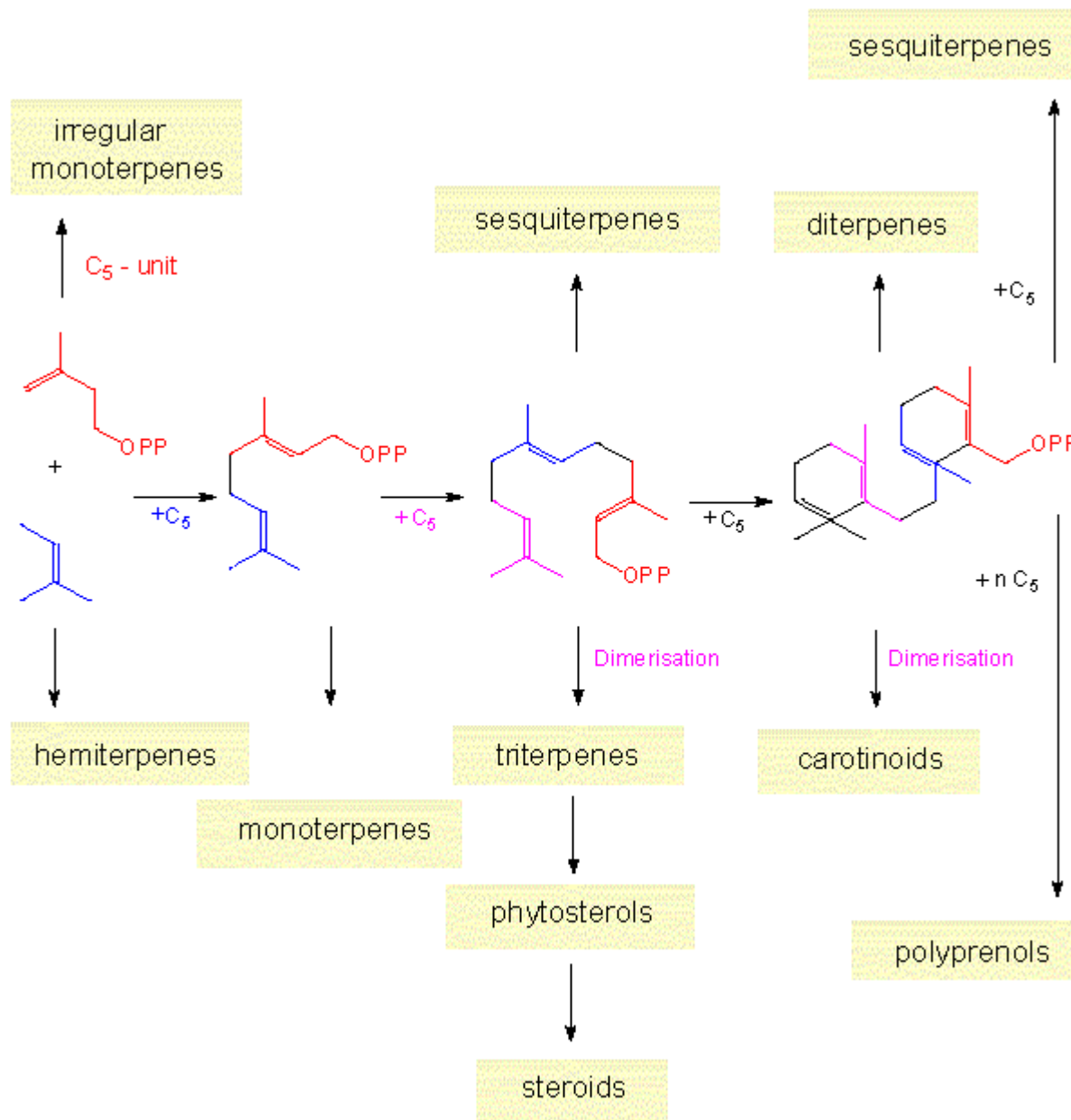
Terpenoidy

Monoterpenoidy (C 10)

Seskviterpenoidy (C 15)

Diterpenoidy (C 20)

Triterpenoidy (C 30)



Monoterpenoidy

- *Terpentýnový olej*
- *Kafr*

Kafr je látka dříve získávaná odstředěním a sublimací vyčištěného podílu destilace dřeva skořicovníku kafrového (*Cinnamomum camphora*) nyní synteticky.



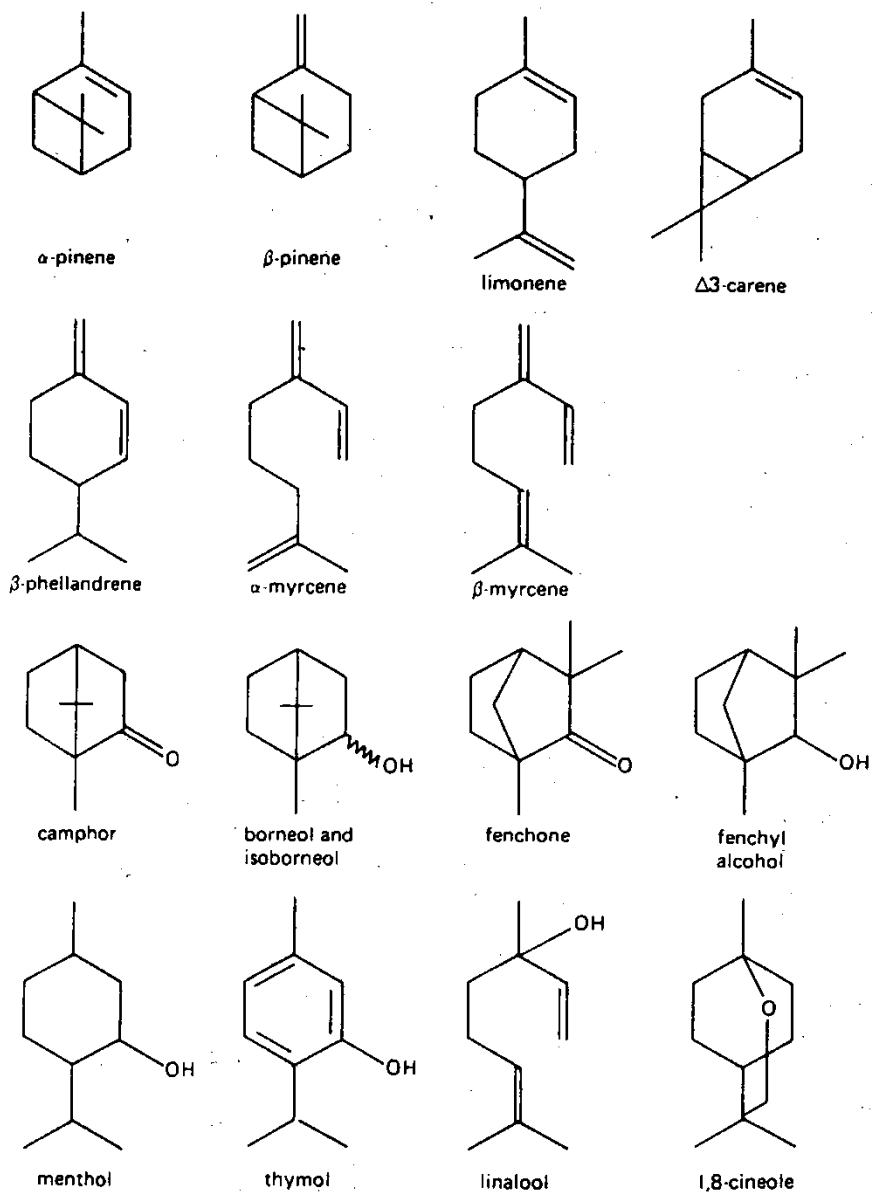
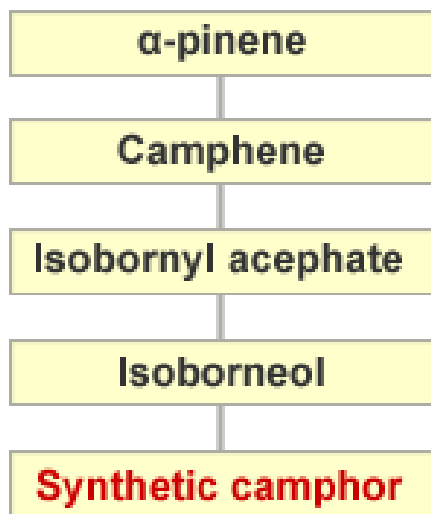


Figure 8.1 The structures of some monoterpenoid components of oil of turpentine and essential oils.

Pryskyřice

Rostlinného původu

recentní

fosilní

Živočišného původu

Terpenoidní a ne-terpenoidní

Rozpustné zejm. v málo polárních a nepolárních rozpouštědlech

Příprava laků , politur, adheziv

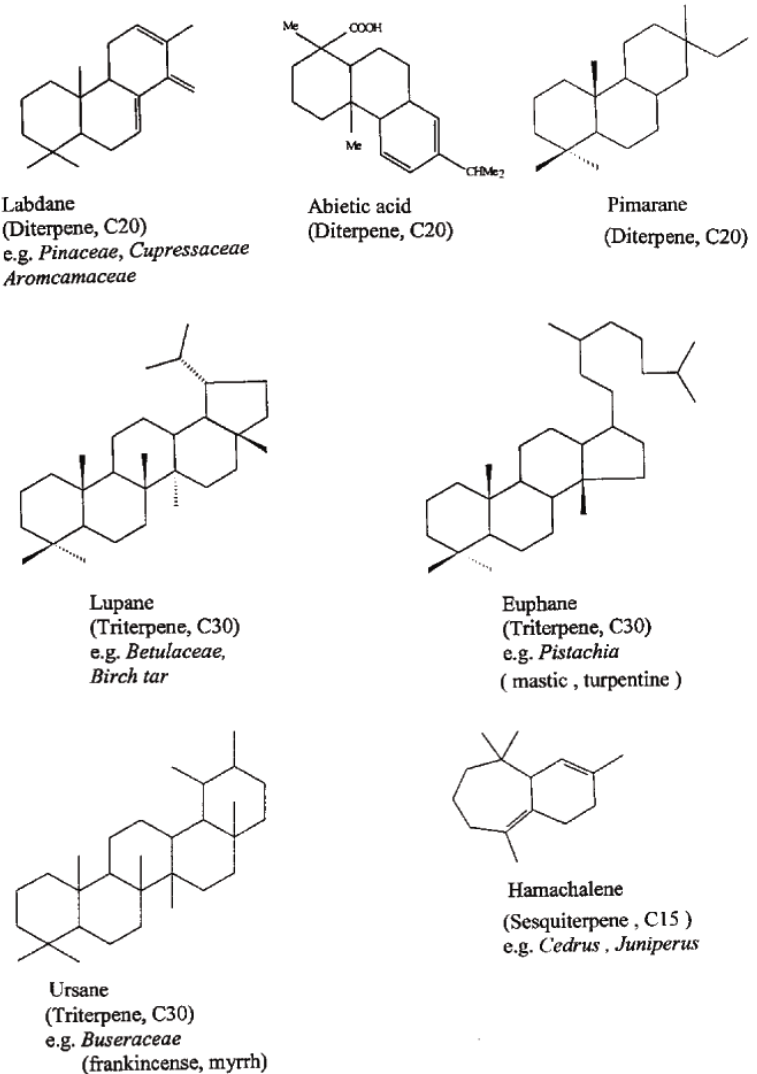
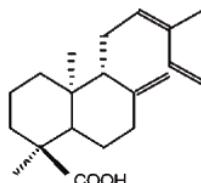


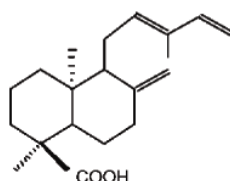
Figure 4. Molecular structures of some key parent constituents of ancient resins.

Diterpenoidní pryskyřice

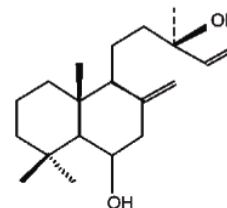
Labdanes



ozic acid

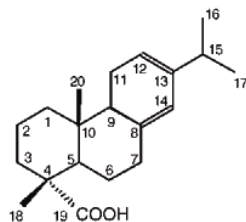


communic acid

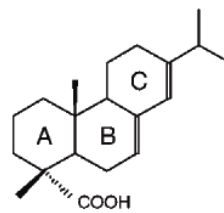


larixol

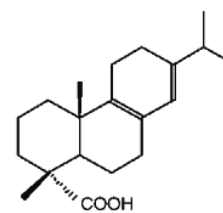
Abietanes



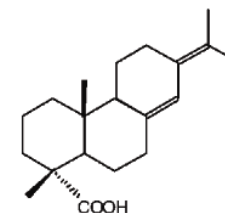
laevopimaric acid



abietic acid

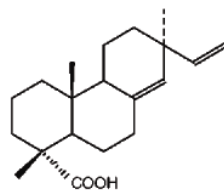


palustric acid

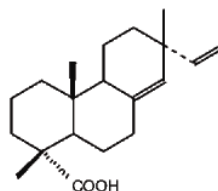


neoabietic acid

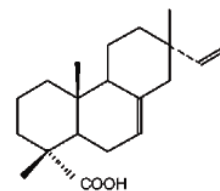
Pimaranes



pimaric acid



sandaracopimaric acid



isopimaric acid

Scheme 1. Diterpenoid labdanes, pimaranes and abietanes from Pinaceae resins. Carbon numbers are depicted for one compound according to common nomenclature.

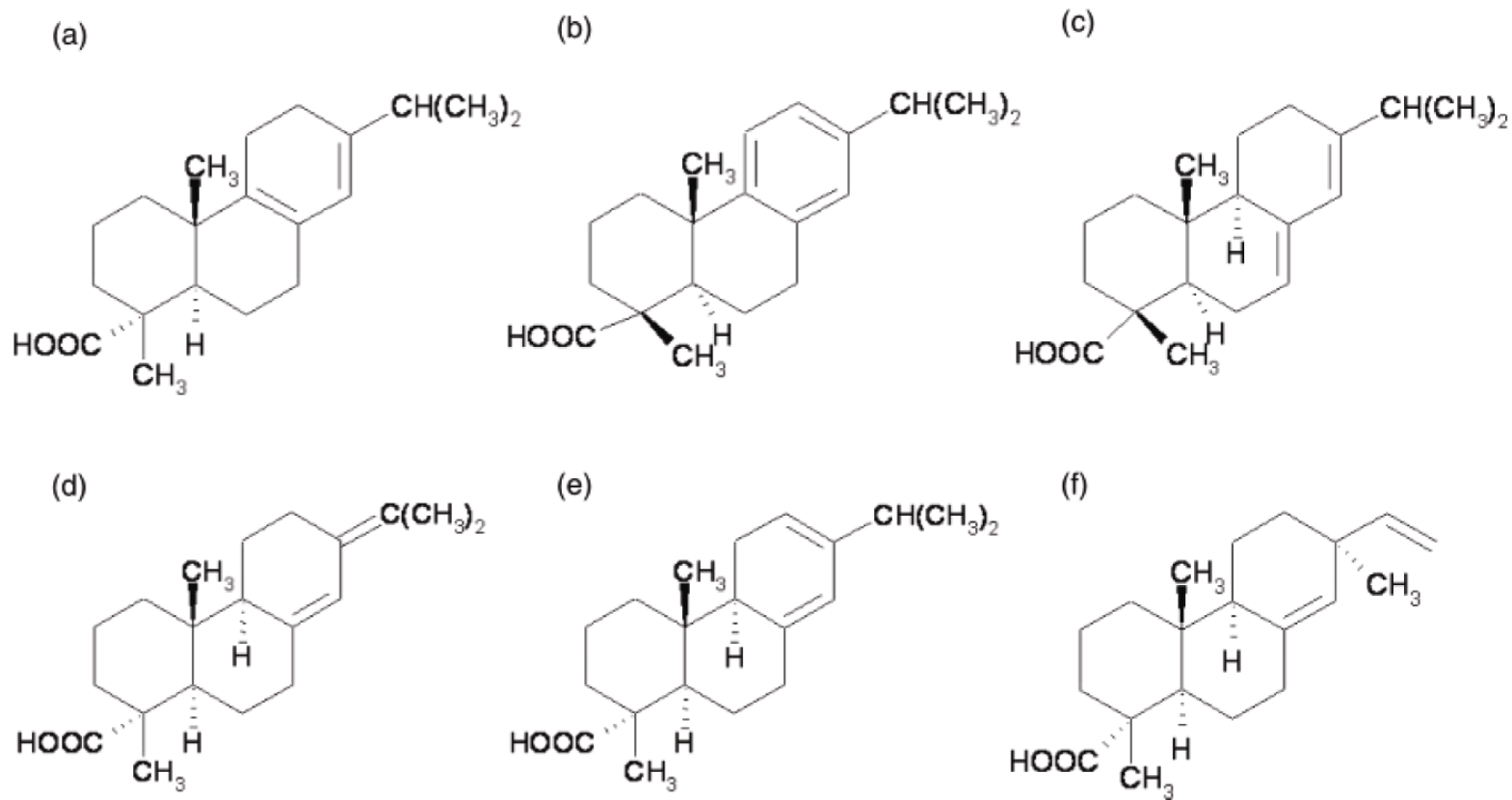


FIG. 1—Chemical structures of principal resin acids: (a) palustric acid; (b) dehydroabietic acid; (c) abietic acid; (d) neoabietic acid; (e) levopimaric acid; (f) pimaric acid.

Borová pryskyřice, kalafuna, rosin



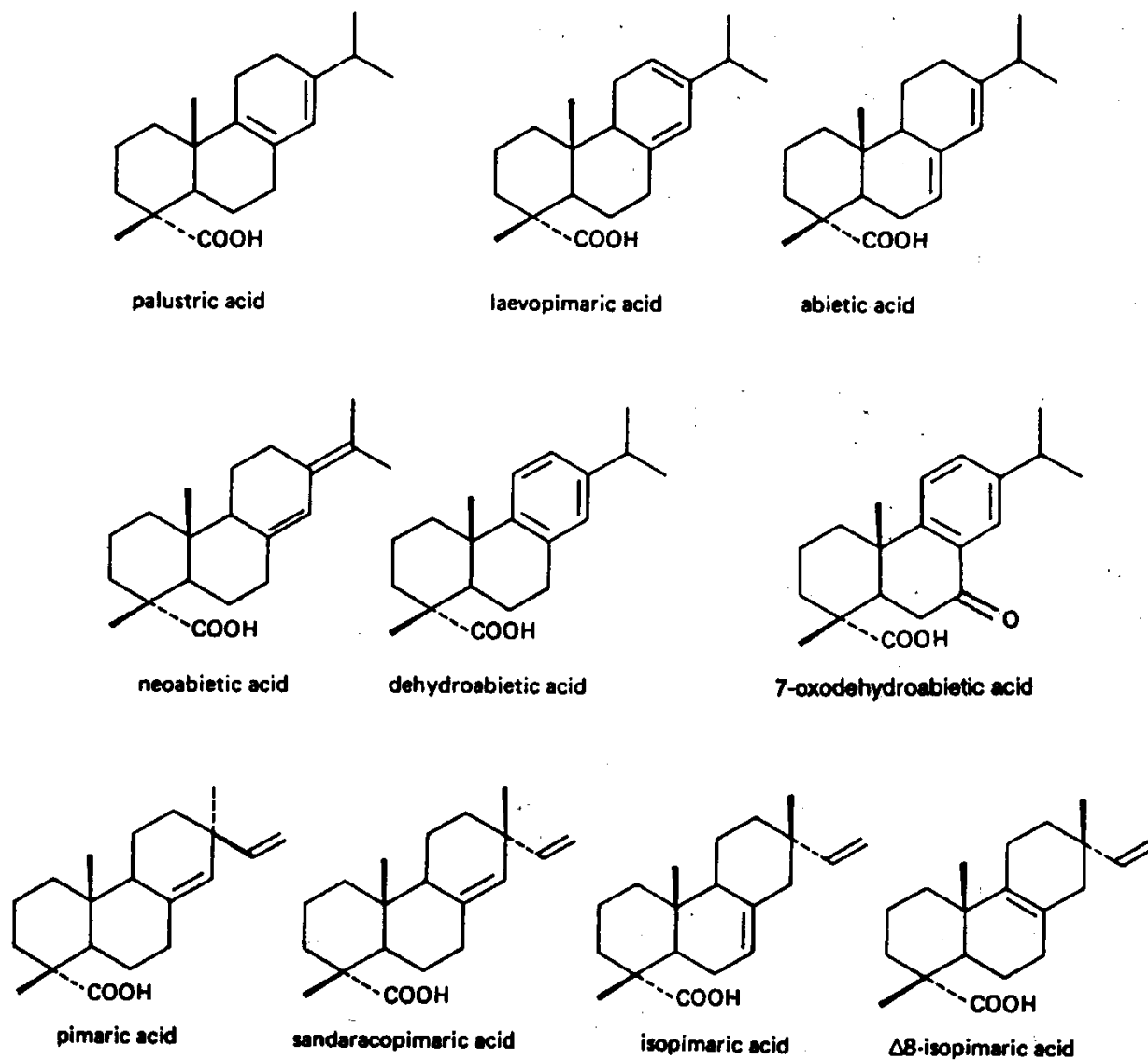
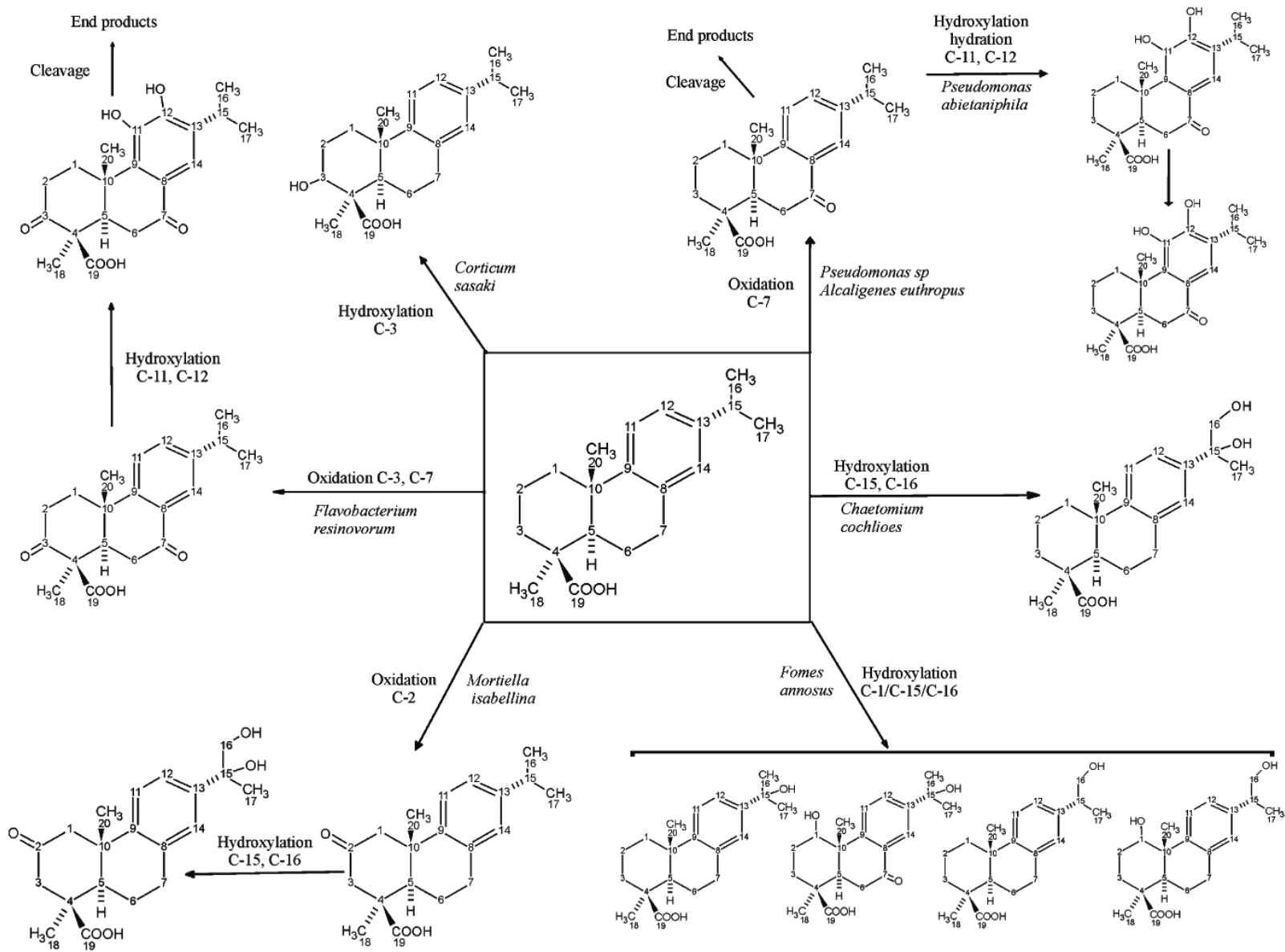


Figure 8.2 The structures of some abietane and pimarane diterpenoid components of conifer resins. 7-oxodehydroabietic acid is not an original component but is commonly found in old, oxidized samples.



Scheme 2 Scheme showing the proposed pathways for the biodegradation of abietadienes

Štrasburský balzám

Abies alba

Získává se z pryskyřice
jedle bělokoré.



Kanadský balzám

Abies balsamea

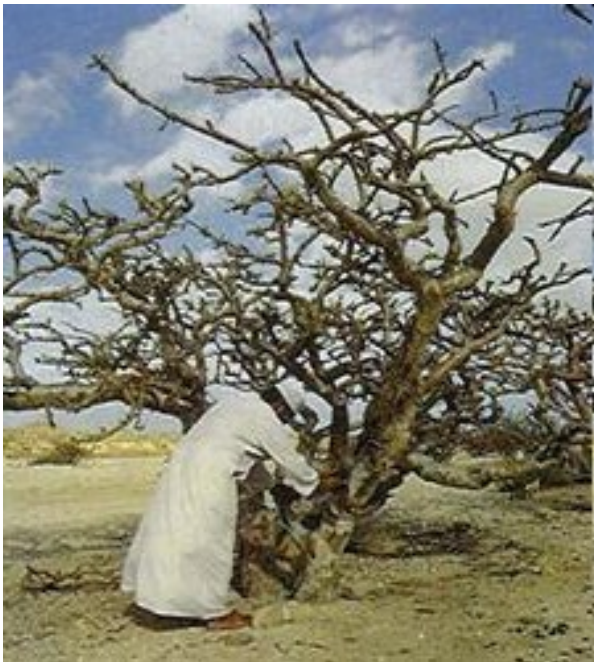


Získává se z pryskyřice jedle kanadské. Používal se při přípravě mikroskopických preparátů.



Myrrha

Commiphora myrrha



Guggul



bdelium

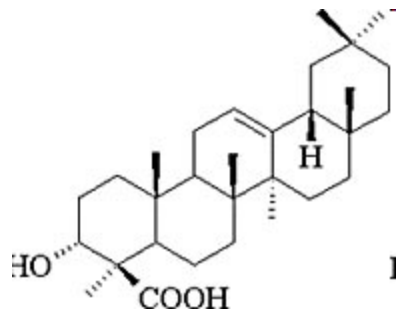


Commiphora wightii (Arn.) Bhandari - An endangered and highly medicinal plant

S Afrika, Stř. Asie, S Indie

Kadidlo

Boswellia





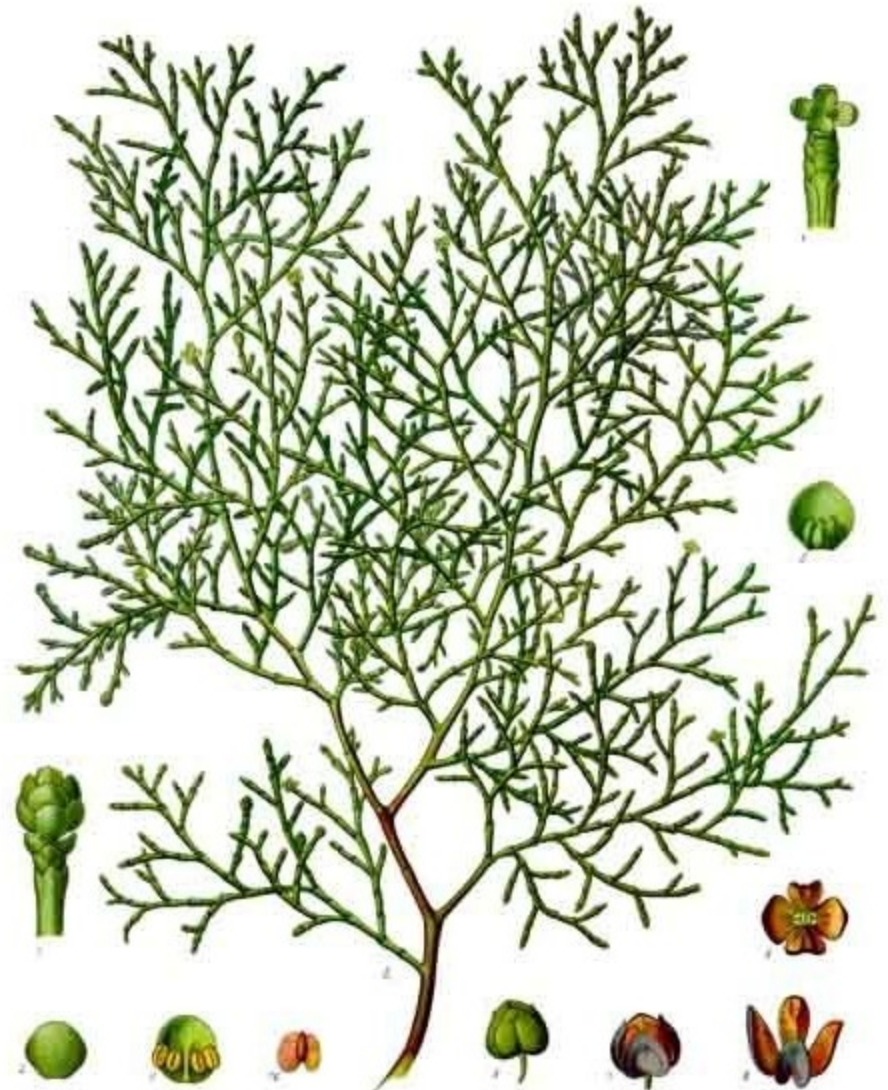
Použití myrrhy, kadidla a mastixu

Kultovní účely (vykuřování)

Mumifikace



Sandarak



Manilský kopál



Agathis alba



Kauri

novozélandský jehličnan pěstovaný pro
cenné dřevo a pryskyřici.



Agathis robusta

Fosilní pryskyřice

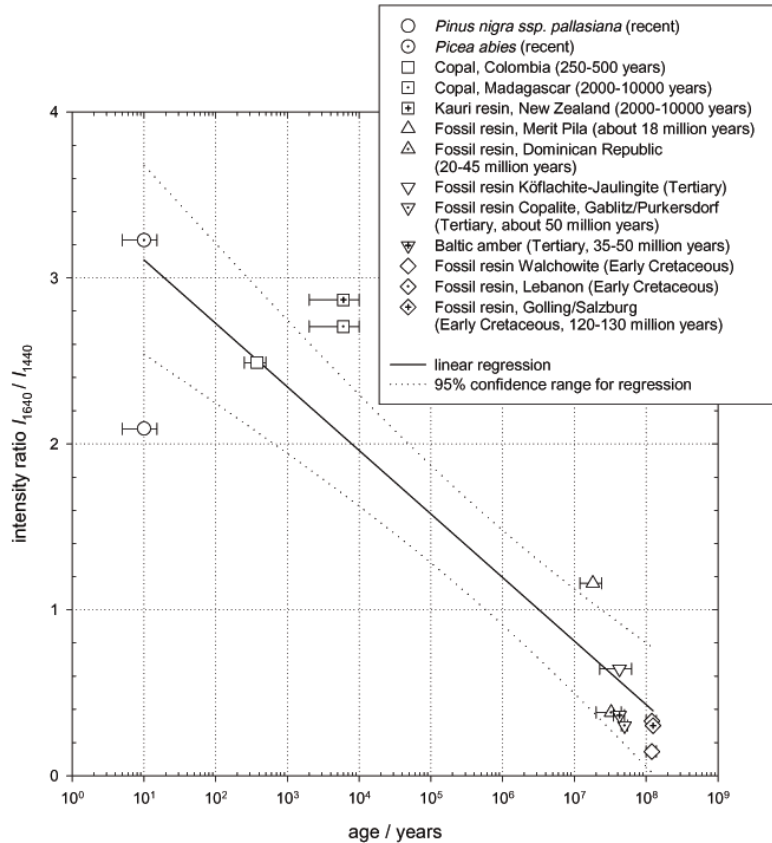


Figure 2. Plots of intensity ratio ($1640/1440 \text{ cm}^{-1}$) as a function of age.

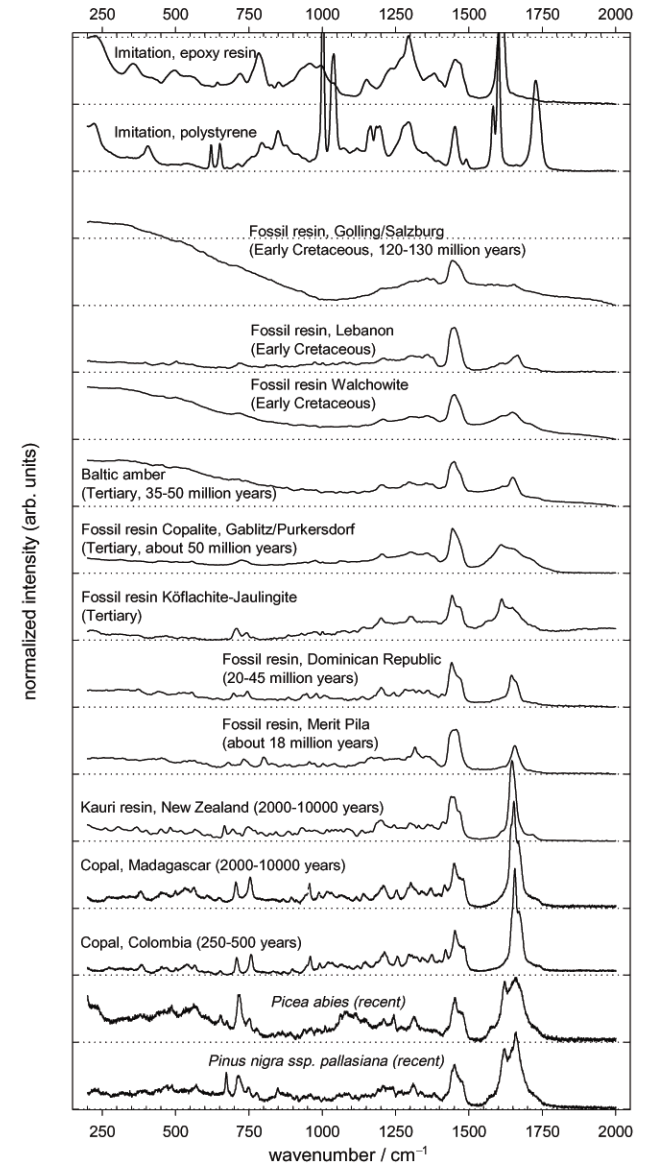


Figure 1. Raman spectra of recent (bottom) to fossil resins and imitation materials (top); intensity normalized for equivalent intensity of the 1440 cm^{-1} band. Note the age-dependent intensity change of the 1640 cm^{-1} band relative to the 1440 cm^{-1} band in natural resins.

Jantar



Ambroid

= lisovaný jantar (drobné kousky jantaru se hydraulicky slisovaly v ocelové formě)

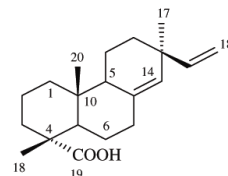
náustky dýmek

cigaretové špičky

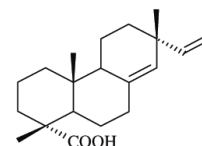


Triterpenoidní pryskyřice

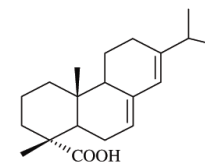
Diterpenoids



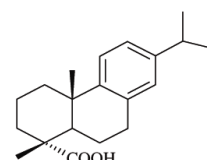
pimaric acid



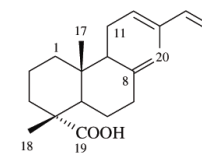
sandaracopimaric acid



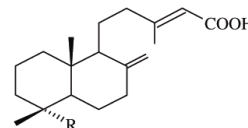
abietic acid



dehydroabietic acid

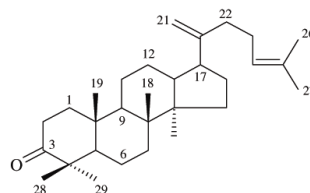


trans-communic acid

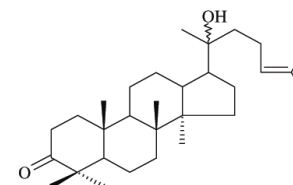


R=COOH agathic acid
R=CH₂OH agatholic acid
R=CH₂OAc acetoxyagatholic acid

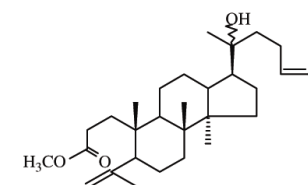
Triterpenoids



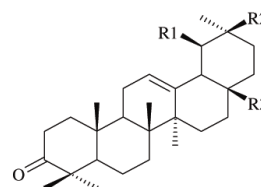
dammaradienone



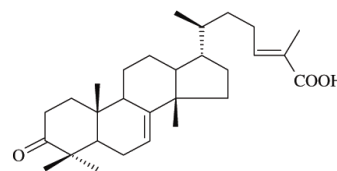
hydroxydammarenone



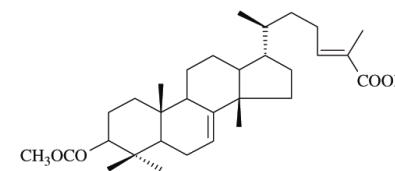
dammarenolic acid



R₁=H R₂=CH₃ R₃=CHO oleanonic aldehyde
R₁=CH₃ R₂=H R₃=CHO ursonic aldehyde
R₁=H R₂=CH₃ R₃=COOH oleanonic acid
R₁=CH₃ R₂=H R₃=COOH ursonic acid
R₁=H R₂=CH₃ R₃=COOH moronic acid*
(*) double bond located at C₁₈



(iso)masticdienonic acid



3-O-acetyl-3-epi(iso)masticdienonic acid

Scheme 1. Structures of some diterpenoids and triterpenoids.

Mastix (masticha)

Pistacia lentiscus

(pistáciová pryskyřice)



pryskyřice získávaná z malého mastichovníku *Pistacia lentiscus* z čeledi sumakovitých, který se vyskytuje hlavně ve středomořských zemích. Při poranění kůry stromu pryskyřice vytéká ve formě kapek.



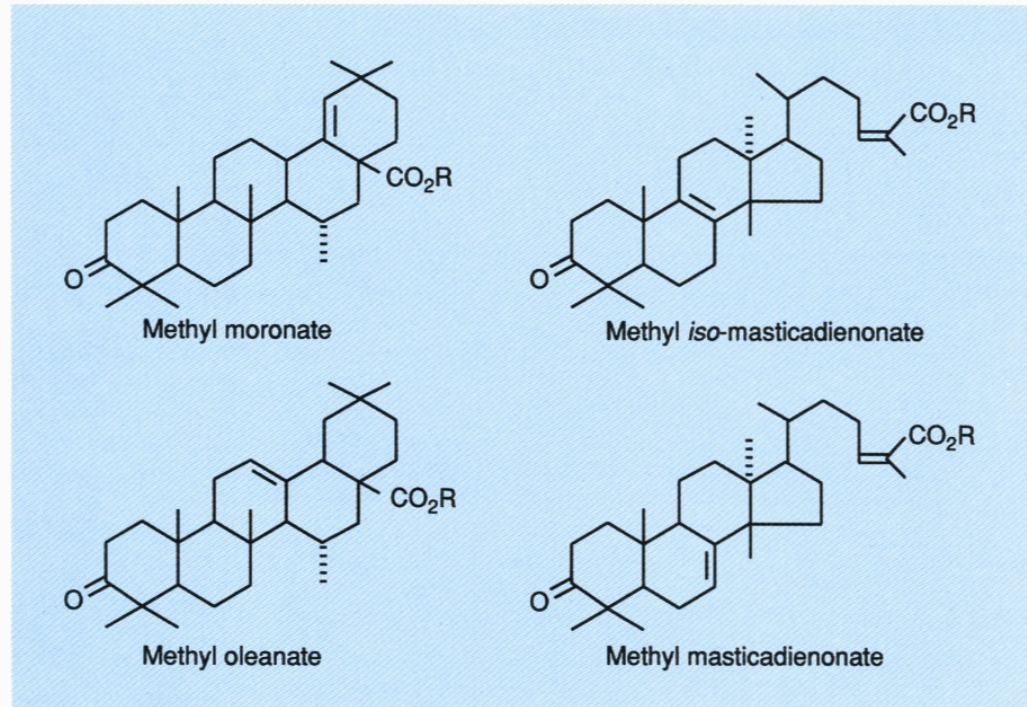
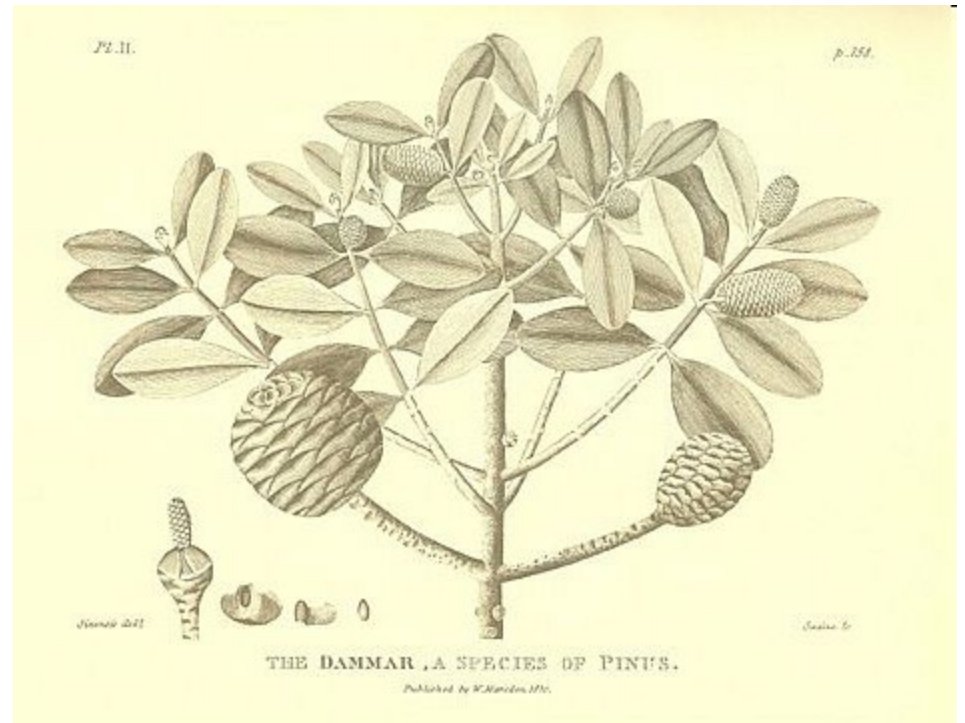


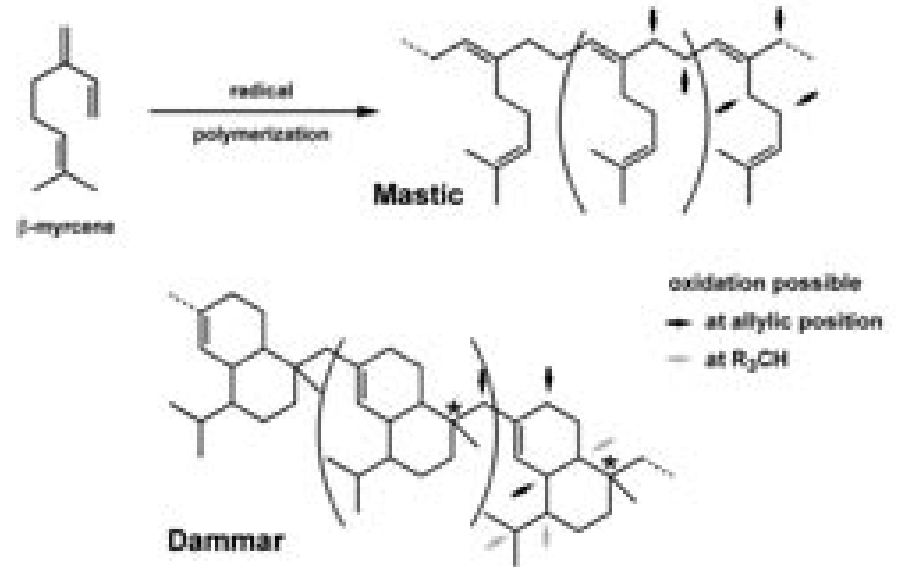
Figure 1. Major acid constituents of the genus *Pistacia* resins ($\text{R} = \text{CH}_3$).

Masticha je průhledná a má světle žlutou až zelenou barvu. Ve starověku se masticha používala především jako lepidlo, k výrobě laku, jako lék a k aromatizaci.

Damara



Damara



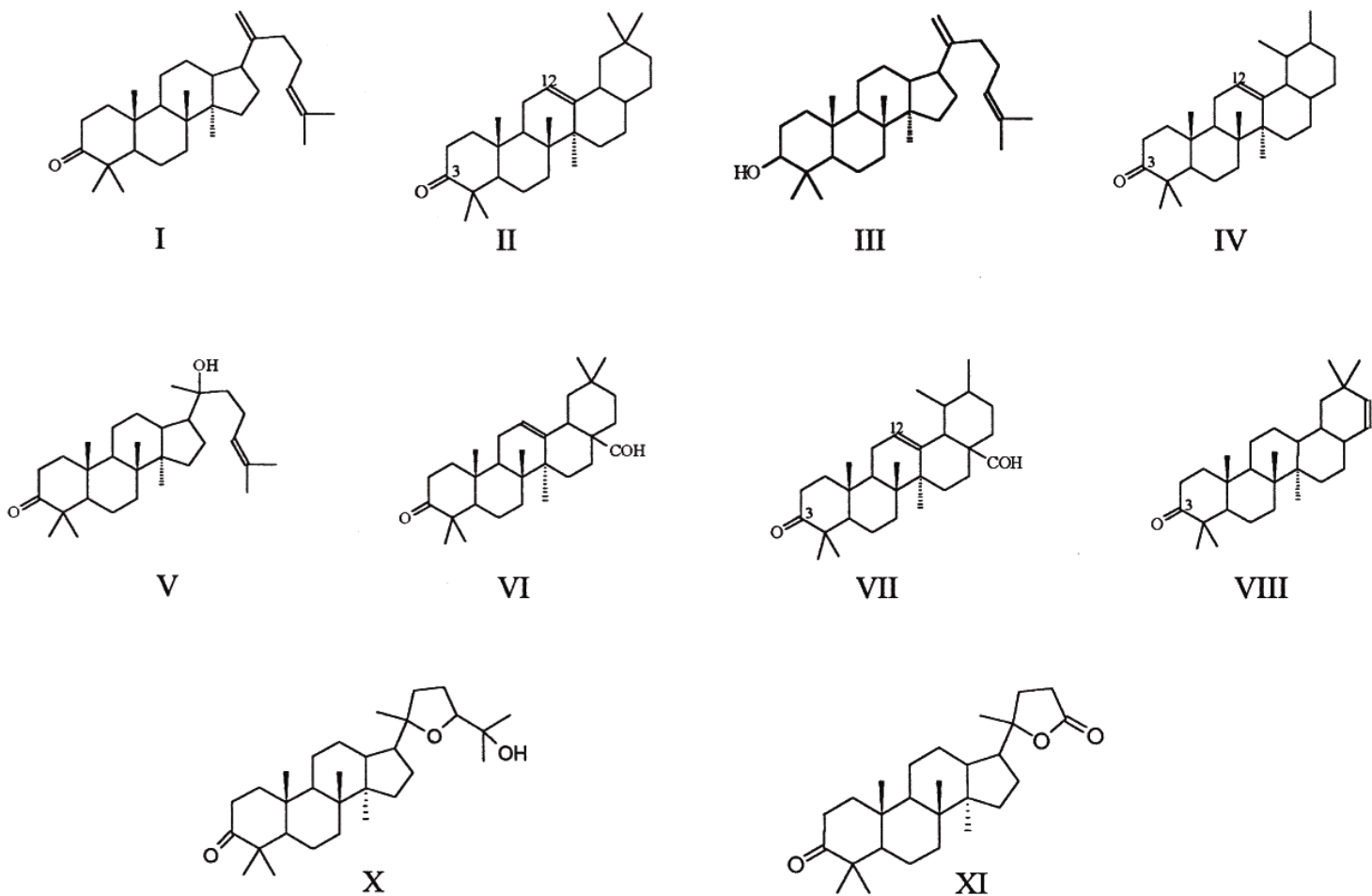


Fig. 3. Molecular structures of the main neutral components of dammar and mastic resin: I, dammaradienone [3-oxo-dammara-20(21),24-diene, $C_{30}H_{48}O$, MW 424]; II, nor- β -amyrone (3-oxo-28-nor-olean-12-ene, $C_{29}H_{46}O$, MW 410); III, dammaradienol (3-hydroxi-dammara-20,24-diene, $C_{30}H_{50}O$, MW 426); IV, nor- α -amyrone (3-oxo-28-nor-urs-12-ene, $C_{29}H_{46}O$, MW 410); V, hydroxydammarone (3-oxo-20-hydroxy-dammar-24-ene, $C_{30}H_{50}O_2$, MW 442; two stereoisomers exist, which are reported to be epimeric at C_{20} [3], one of the two is also known as dipterocarpol); VI, oleanonic aldehyde (3-oxo-olean-12-en-28-al, $C_{30}H_{46}O_2$, MW 438); VII, ursanic aldehyde (3-oxo-urs-12-en-28-al, $C_{30}H_{46}O_2$, MW 438); VIII, nor-olean-17(18)-en-3-one ($C_{29}H_{46}O$, MW 410); X, 20,24-epoxy-25-hydroxy-dammaren-3-one ($C_{30}H_{50}O_3$, MW 458); XI, 3-oxo-25,26,27-trisnordammarano-20,24-lactone ($C_{27}H_{42}O_3$, MW 414).

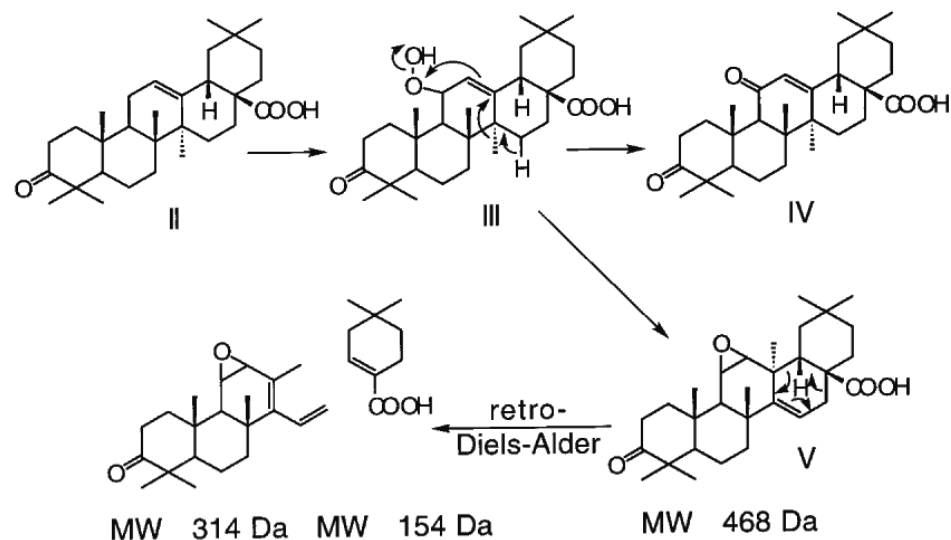
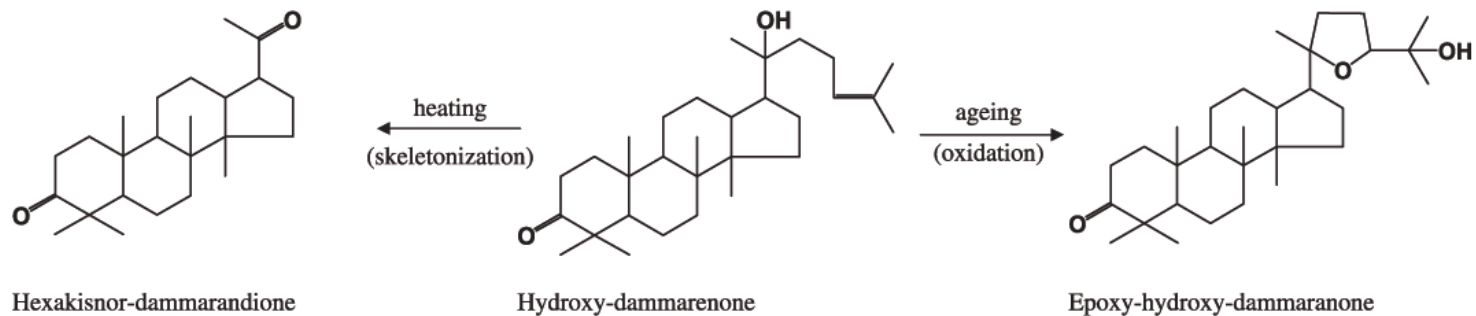


Figure 5. Reactions proposed to take place during the aging of dammar and mastic. Oxidative rearrangement III→V was demonstrated to occur in aging of solutions of β -amyrin with sunlight by Agata et al.³⁰ Structures of type V can very easily undergo a retro-Diels–Alder reaction (demonstrated for a derivative by Melera et al.³¹). Reactions of these types could occur in the aging of dammar and mastic components having an oleanane and ursane skeleton. The peroxide III is an intermediate formed by autoxidation of oleanonic acid (II) that can also be oxidized to IV. Structure IV was found in naturally aged varnishes from paintings.⁸



Scheme 1 *Hydroxy-dammarenone and its ageing and heating products.*

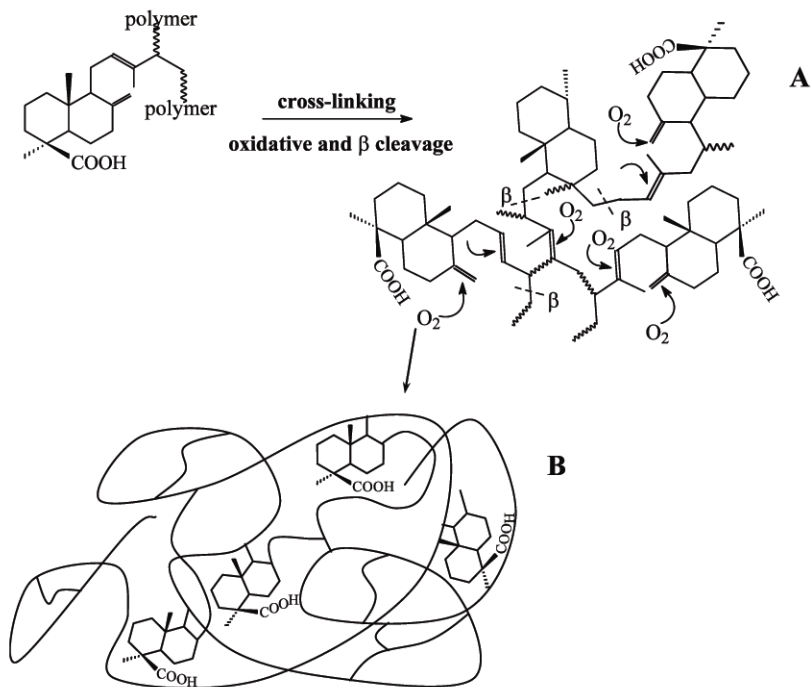


Fig. 8. Degradation scheme of the communic acid-based polymer. (a) Carbon-carbon double bonds are active site for cross-linking and cleavages. Cleavage reactions occur with radical mechanisms: β -scission or oxidative scission. (b) Cross-linking proceeds further, leading to a saturated network of bicyclic units connected by a polymer chain.

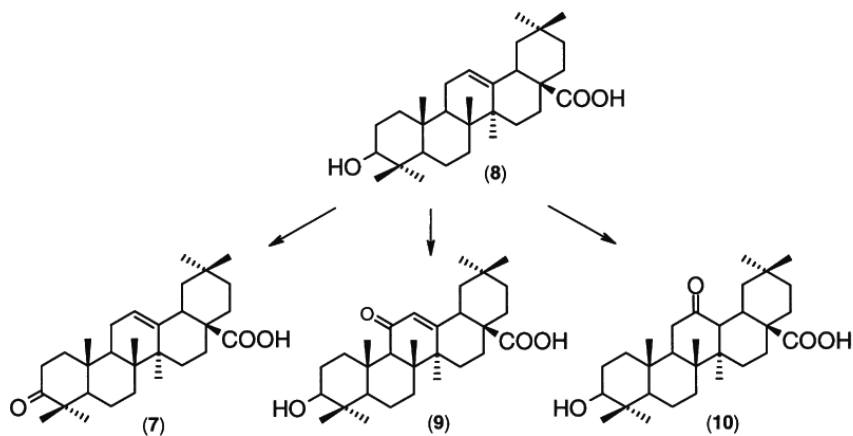


Fig. 7. Proposed oxidation mechanism of oleanolic acid.

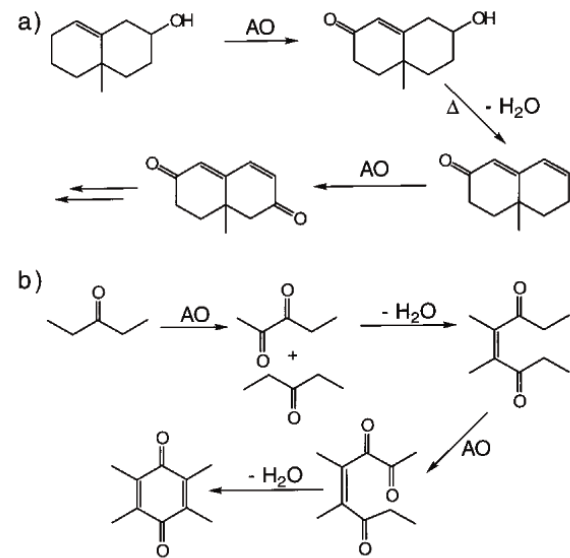
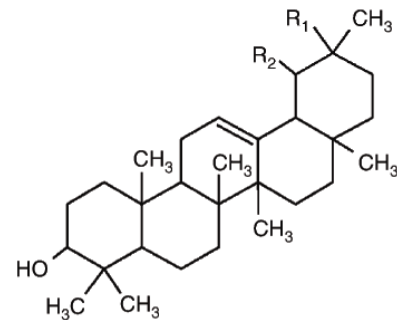


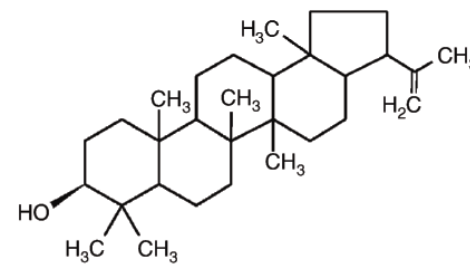
Figure 10. Autoxidation (AO) occurring in darkness gives a straightforward explanation for yellowing. C=C bonds are converted to unsaturated ketones via allylic oxidation, and elimination of hydroxy groups enlarges the unsaturated system. Subsequent autoxidation could lead to conjugated diketones, which are yellow (a). Combination of condensation reactions with autoxidation can also lead to unsaturated diketones or quinones (b).

Elemi

Canarium luzonicum



- (1) $R_1 = H$ $R_2 = CH_3$ α -Amyrin
(2) $R_1 = CH_3$ $R_2 = H$ β -Amyrin



- (3) Hop-22(29)-en-3 β -ol

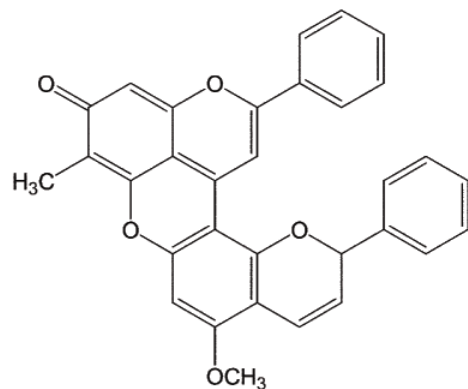
Fig. 1. Chemical structure of the main components of the triterpenoid fraction of *Burseraceae* resins: (1) α -amyrin, (2) β -amyrin and (3) hop-22(29)-en-3 β -ol.

Dračí krev

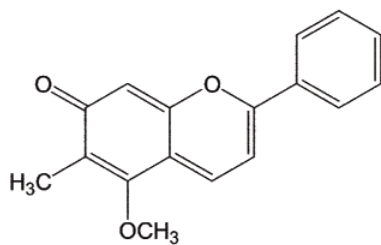
Dragon's blood, a red resin described by Dioscorides, the Greek botanist from the first century c.e. and by other early writers, was derived from a number of different plants. A main source of the resin seems to have been *Dracaena cinnabari*, a tree of the agave family, from which it is exuded as garnet colored drops when the trunk or branches of the tree are injured. The early Greeks and Romans believed dragon's blood to have medicinal properties. Its main use in the ancient past, however, was as a coloring material and, since the end of the eighteenth century Italian crafters used it as a varnish for violins.



Dračí krev



Dracorubin



Dracorhodin



Fig. 1 Chemical structures of dracorubin and dracorhodin, the main constituents of dragon's blood resins from *Dracaena*.

Benzoin

Sumatra



Styrax (ambroň)

Styrax officinalis

benzoin

(2-hydroxy-2-fenylacetofenon)

Zpracovává se jak pryskyřice, tak
dřevo i kůra



Table 2

Compounds identified in benzoe resin, storax resin and in sample 243 collected from an archaeological censer

Compound	Benzoe	Storax	Archaeological censer
Benzoic acid	+	+	+
4-Hydroxybenzaldehyde	+		+
Resorcinol	+	+	+
Vanillin	+		+
Cinnamic acid	+	+	+
3-Hydroxybenzoic acid	+		+
4-Hydroxybenzoic acid	+		+
Vanillic acid	+		+
Cinnamyl alcohol	+	+	+
4-Hydroxy-benzenepropanol		+	
<i>p</i> -Hydroxycinnamic acid		+	
Oleanolic acid		+	
Oleanonic acid		+	+
3-Phenyl-2-propanol		+	

Peruánský balzám

Peruánský balzám pochází z extrahované tekutiny (tzv. pryskyřice) z kůry balzámovníku. Voní po vanilce a působí antisepticky, proto se peruánský balzám nachází v mnoha výrobcích, jako je šampon, kondicionér a pleťová voda.



Copaiba

Olejovitá pryskyřice
(genus *Copaifera*)

J Amerika



Šelak

z výměšků samičky červce lakového (*Kerria lacca*)
(Indie, Thajsko)

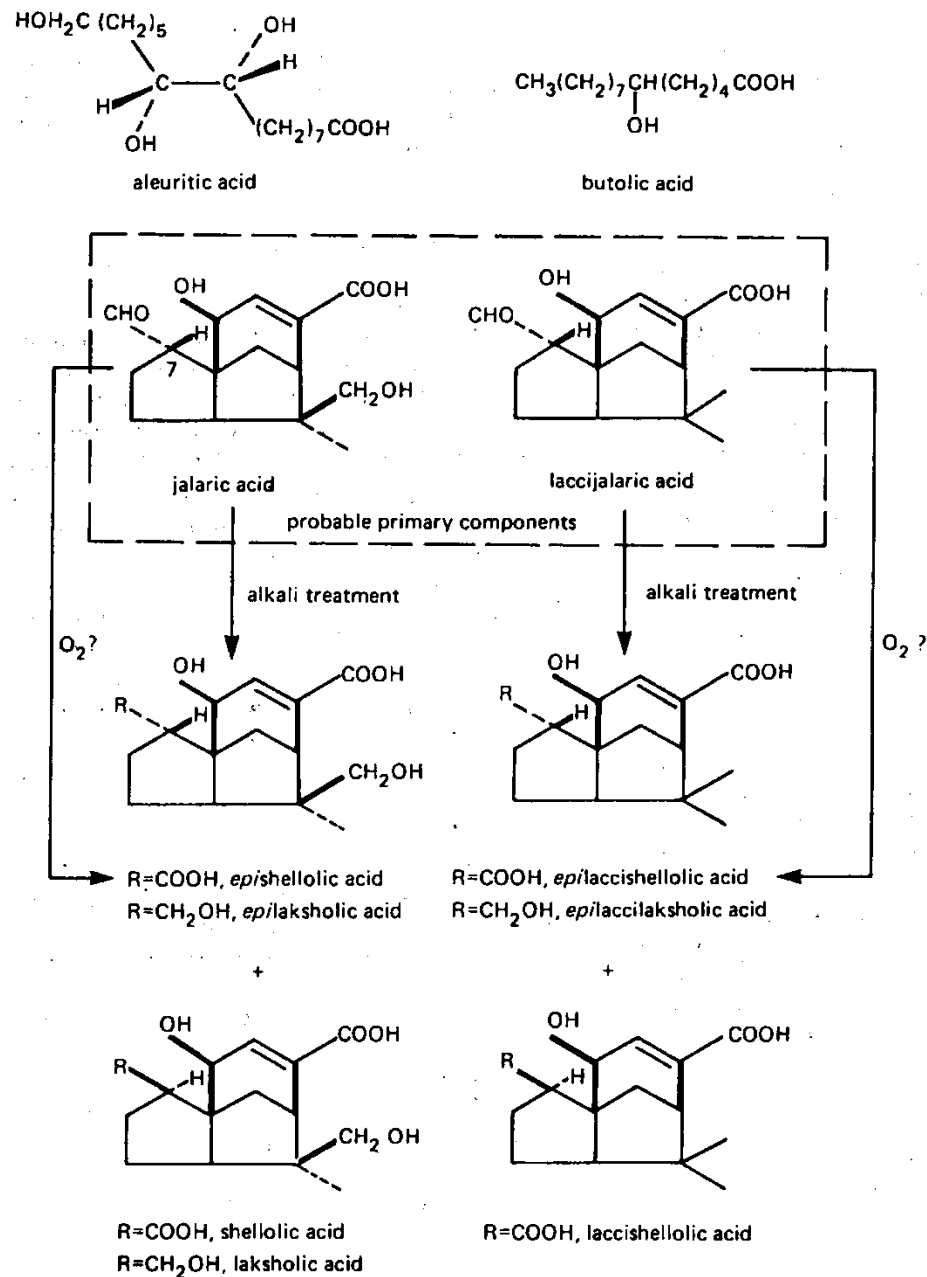


Figure 8.8 Aliphatic and sesquiterpenoid components of shellac. The two probable 'primary' sesquiterpenoids are shown in the dotted box; the other compounds below could result from the alkali treatment used in the isolation procedure, while two of them could also be formed by autoxidation as indicated.

Používá jako barvivo, potravinářská poleva či k povrchové úpravě dřeva.

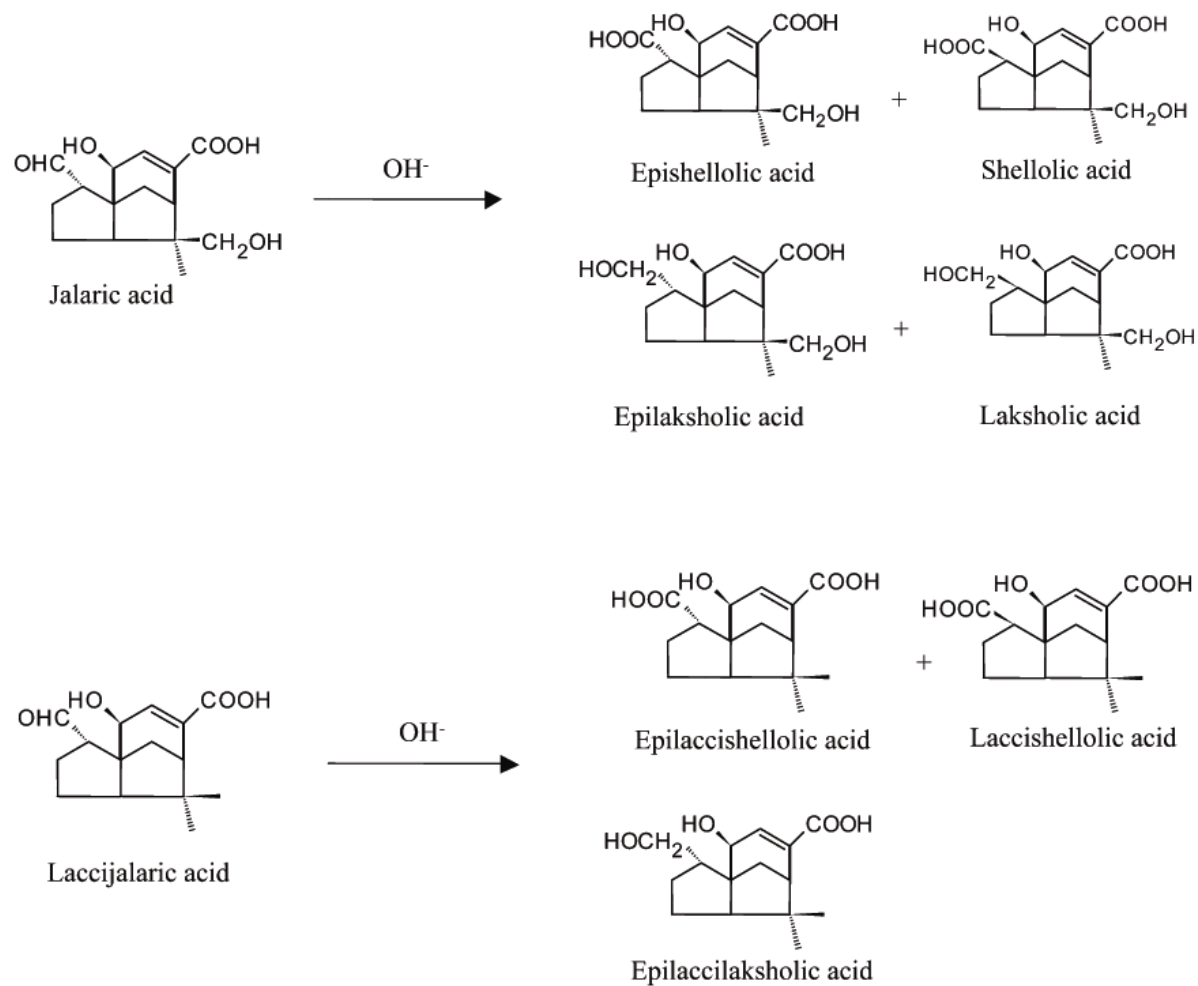
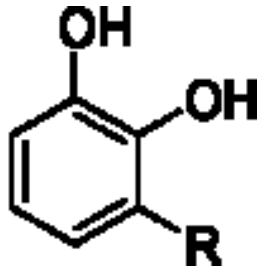


Figure 1. Cannizzaro-type disproportionation of sesquiterpenic compounds under alkaline hydrolysis.

Urushi (japonský lak)

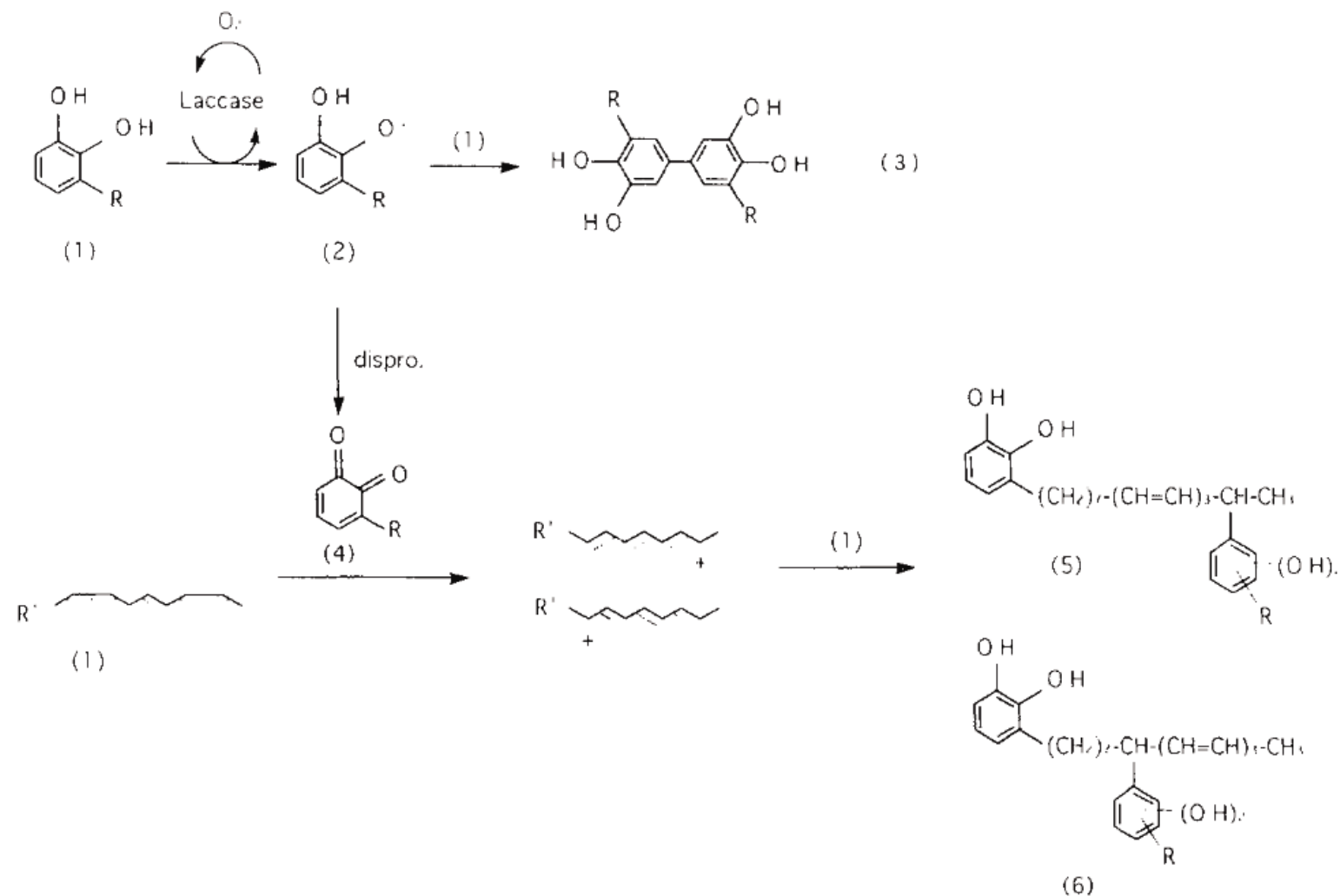
Rhus
vernificera



R = (CH₂)₁₄CH₃ or
R = (CH₂)₇CH=CH(CH₂)₅CH₃ or
R = (CH₂)₇CH=CHCH₂CH=CH(CH₂)₂CH₃ or
R = (CH₂)₇CH=CHCH₂CH=CHCH=CHCH₃ or
R = (CH₂)₇CH=CHCH₂CH=CHCH₂CH=CH₂ and others.



Keramická karafa stará 3 200 let. Podle červeně zbarveného urushi lze usuzovat, že tato karafa mohla být používána jako rituální nádoby. Uruši se však od období Džómon používalo také ke spojování úlomků křehké, při nízkých teplotách pálené keramiky a také jako nátěr, který zabraňoval jejich vytékání.



Scheme 1. Laccase-catalyzed oxidative coupling of urushiol. (1) Urushiol; (2) semiquinone radical; (3) biphenyl dimer; (4) urushiol quinone; (5) nucleus-14th carbon of side chain C–C coupling dimer; (6) nucleus-8th carbon of side chain C–C coupling dimer.

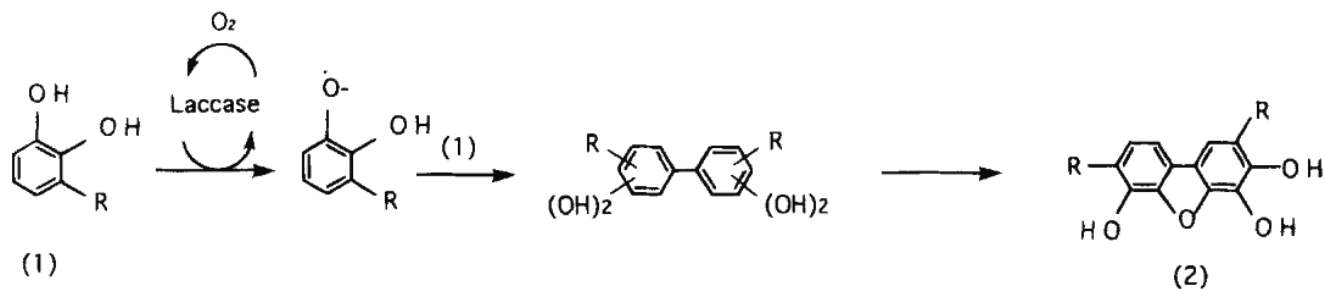


Figure 5. Laccase-mediated oxidative coupling of urushiols: (1) urushiol; (2) dibenzofuran.

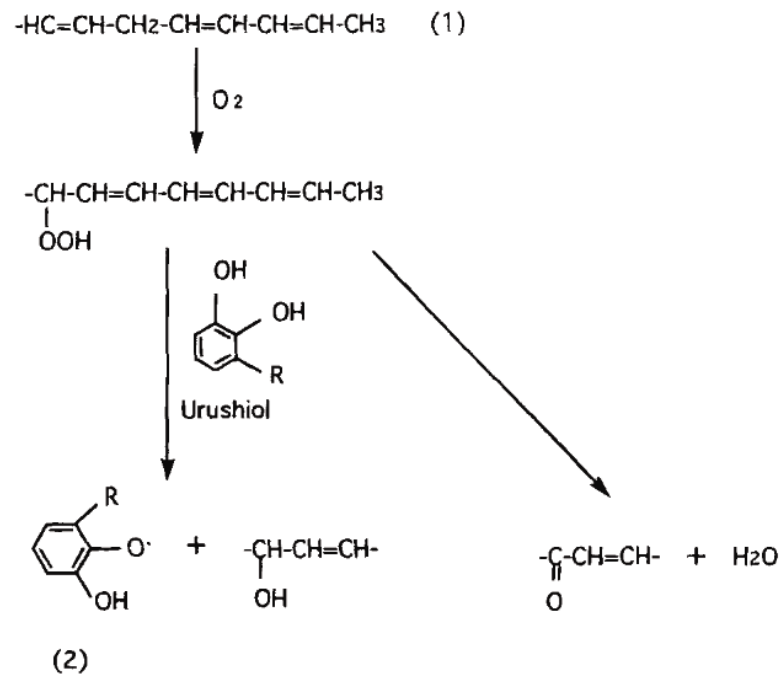
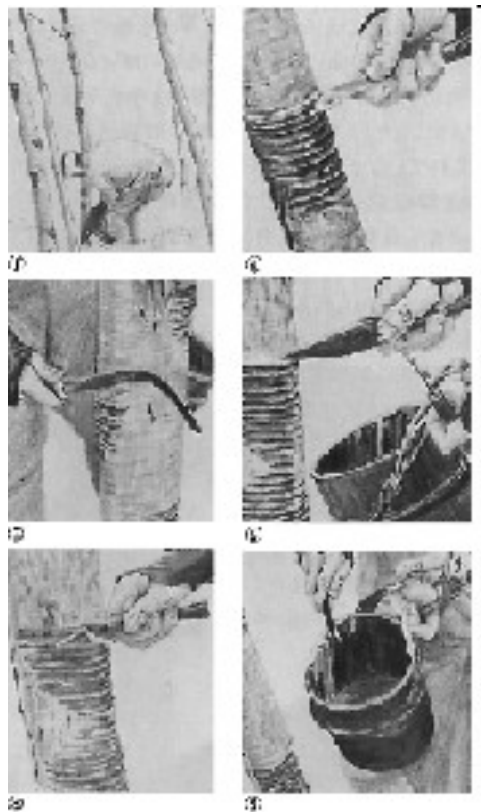


Figure 6. Autoxidation of urushiols: (1) side-chain of urushiol; (2) urushiol-semiquinone.

Aje (axin, mexický lak)

Aje neboli **Axin** je tuková látka produkovaná *Coccus Axin*, polokřídlym hmyzem žijícím na různých druzích Spondias a Xanthoxylum.

V čerstvém stavu má žlutou barvu a zvláštní žluklý zápach, taví se při 35 C, je rozpustná v horkém koncentrovaném lihu a v éteru, snadno se zmýdelňuje a po vystavení se mění na tvrdou hnědou látku, nerozpustnou ve vodě, lihu a éteru.



Coccus Axin



Dřevní kreosot

Produkt suché destilace dřeva při teplotě cca 200-215 °C, může se získávat i ze sazí z nedostatečně suchého dřeva. Hlavní složky jsou kreosol (2-methoxy-4-methyl-fenol) a guajakol (2-methoxyfenol), v menší míře methyلكreosoly, kresoly, xylenoly a j.

- **kreosot technický**, ze dřeva listnatých i jehličnatých stromů, používá se k impregnaci dřeva a jako flotační médium při úpravě rud;
- **kreosot farmaceutický** (lat. creosotum fagi), bezbarvý nebo žlutý, výhradně z bukového dřeva, aby se získal maximální podíl guajakolu a minimální podíl ostatních složek; používal se jako desinfekční prostředek a antiseptikum, proti tuberkulóze a plicnímu kataru a proti dávení.



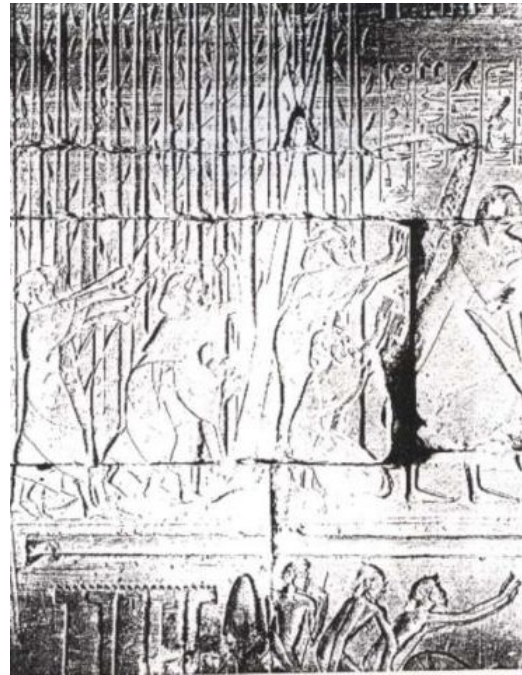
Smolné saze - kreosot

Cedrium



Libanonský cedr (*Cedrus libani*)

Jehličnatý strom s korunou kónického tvaru patřící do čeledi Pinaceae. Je příbuzný s jedlí, což se hlavně projevuje stavbou šišky.



Cedrium

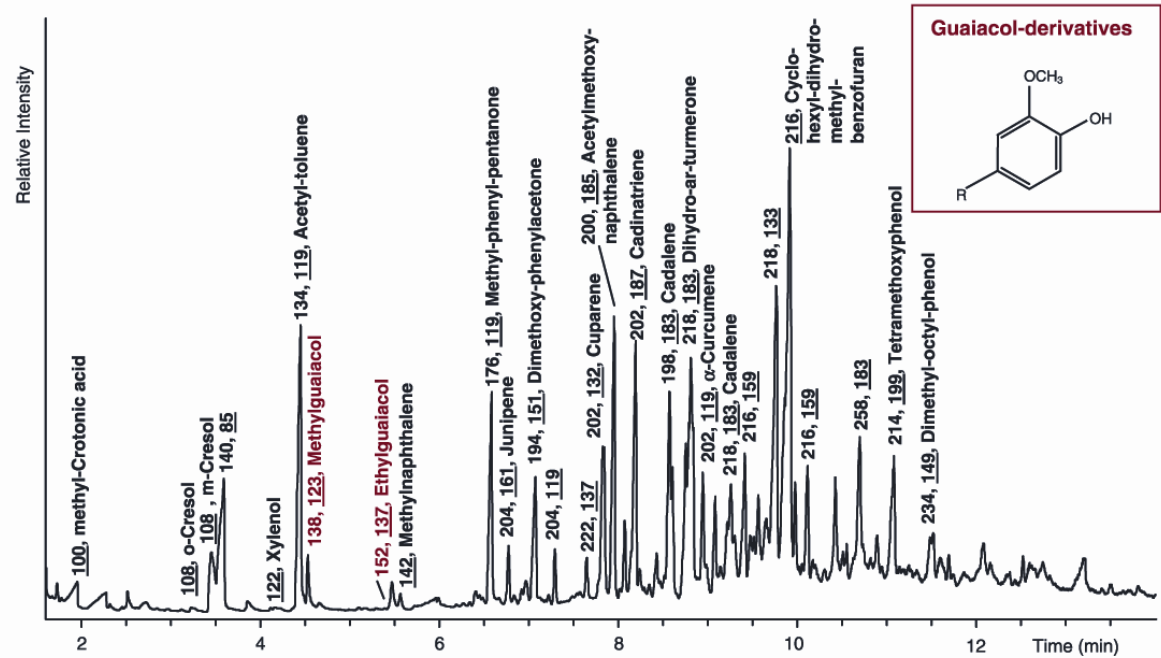
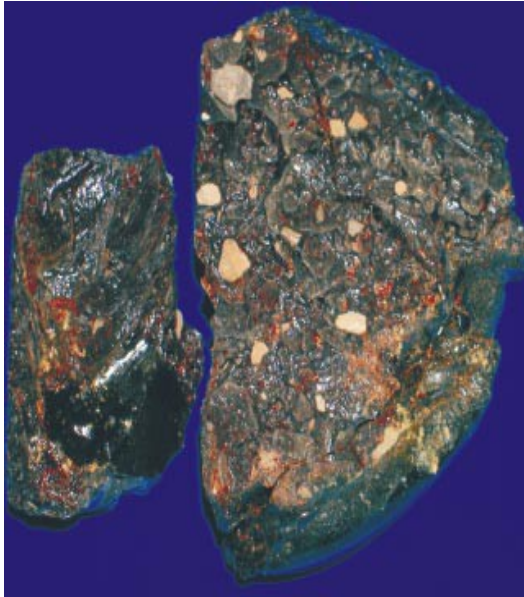


Figure 2 The gas chromatogram of the unused embalming material from Saankh-kare (1500 BC). Analysis of the

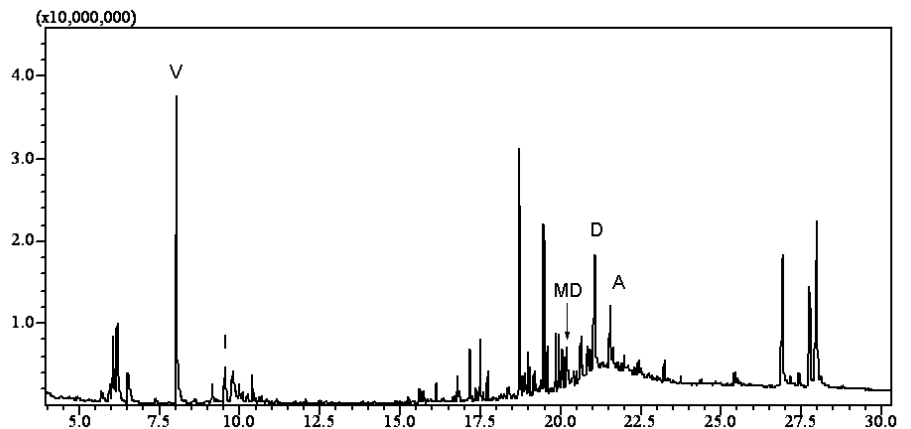
Plinius Starší (23/24–79 n.l.) popisuje technologii:
“Dřevo toho stromu se naštípe, vloží do pecí a zahřívá se ohněm zvnějšku. První kapalina vytéká podobně jako voda trubicí; v Sýrii se to nazývá ‘cedrová šťáva’ [lat: cedrium], a je tak silná, že ji v Egyptě používají k balzamování mrtvých.”

Chromatogram balzamační substance z Saankh-kare (1500 BC).

Borová pryskyřice



Veletiny, šipka typu Štramberk-Krnov



Chromatogram chloroformového extraktu vzorku nativní pryskyřice (A kyselina abietová, PA kyselina pimarová, MD methyl dehydroabietát, D kyselina dehydroabietová, R reten, V vinylguajakol, I isovanilin).

Milíř

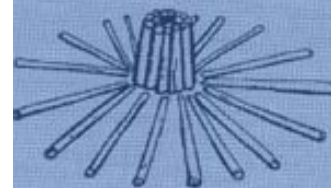
Výroba dřevěného uhlí

Výroba dehtu (jako vedlejší produkt)

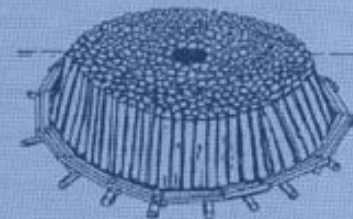


Pálení milíře v roce 1900

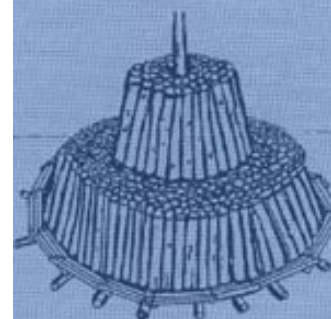
Die wichtigsten Elemente des Meilers sind:



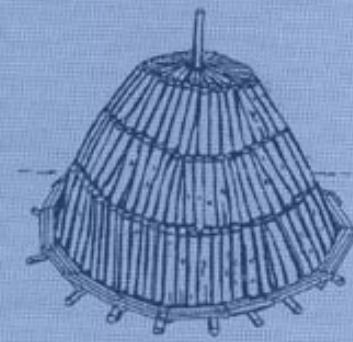
Das Füllhus: Schacht in der Mitte von ca. 20 cm Durchmesser



Der Bodenrost: Holzrost mit Spalten und dünnen Scheitern
Erster Satz: stehende Spalten

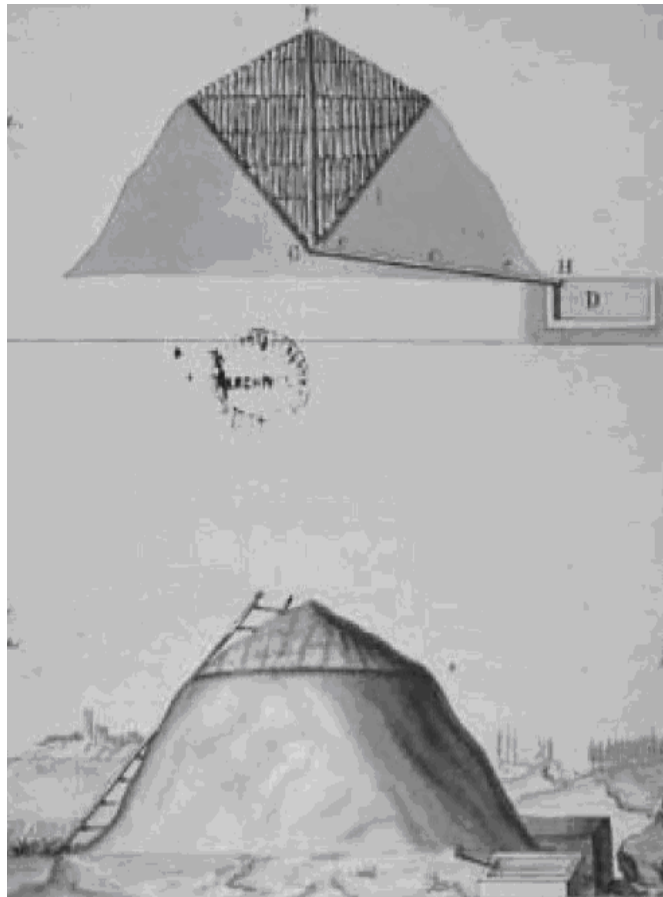
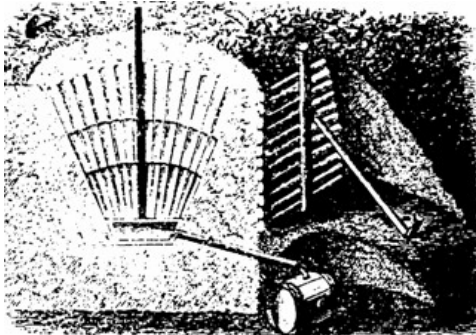


Der Holzstapel: drei bis vier Stockwerke stehender Spalten



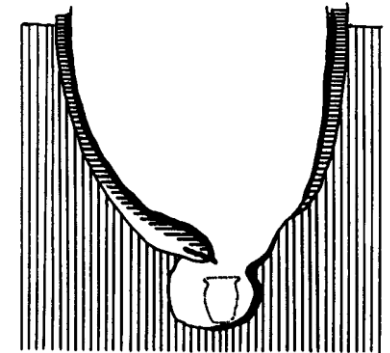
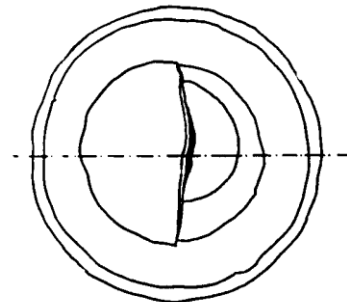
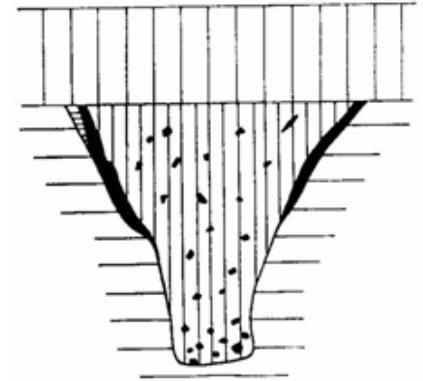
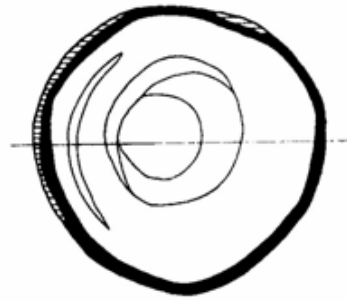
Der Mantel: Reisigmantel, überzogen mit dem «Löschimantel»; dieser besteht aus angefeuchtem Kohलगries. Der Meiler wird damit praktisch luftdicht.

Borová smola / dehet



Varianty
zahlobených
milířů

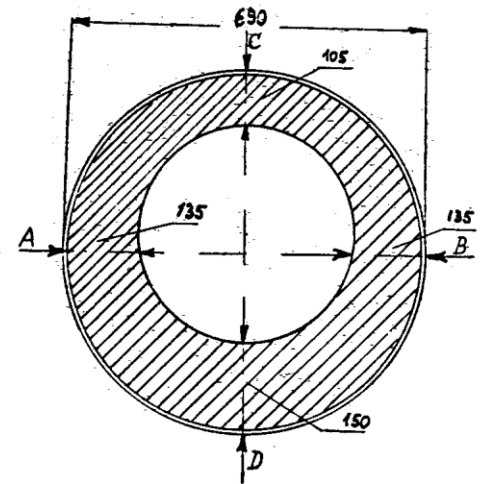
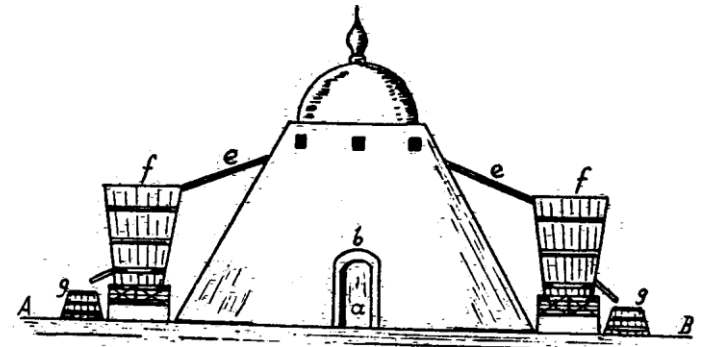
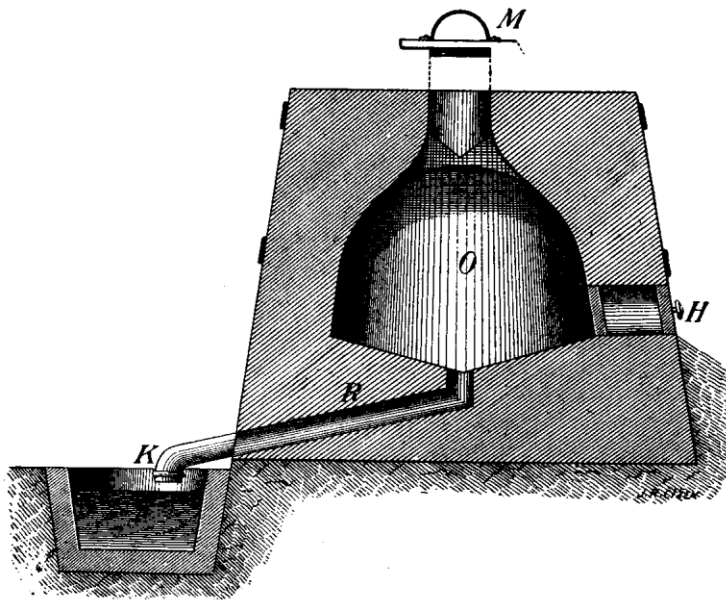
Borová smola /dehet



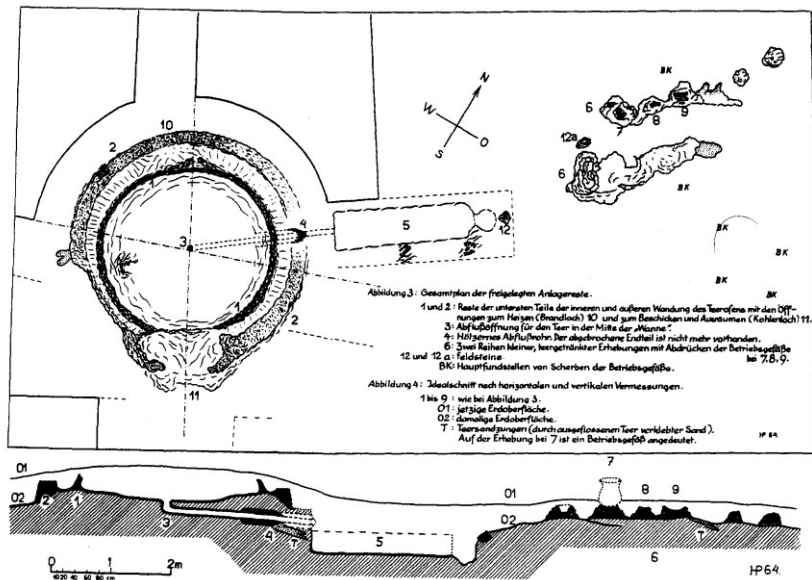
100cm

Borová smola / dehet

Jednokomorové pece



Borová smola /dehet



Pozůstatky středověké dehtařské pece a rafinačního pracoviště z Berlína

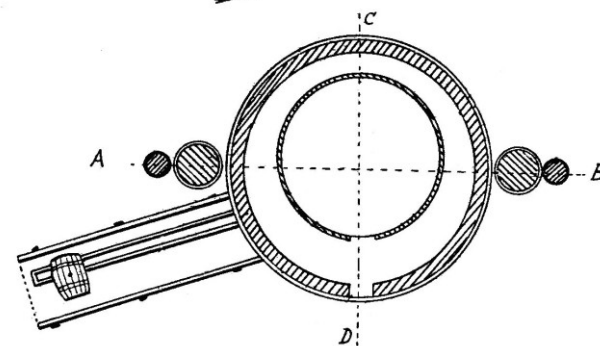
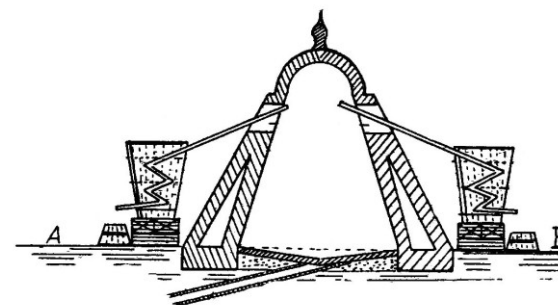
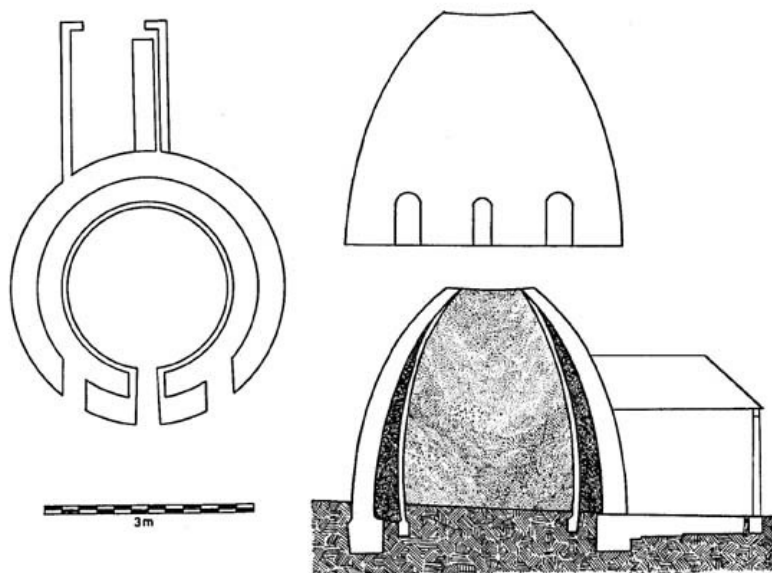
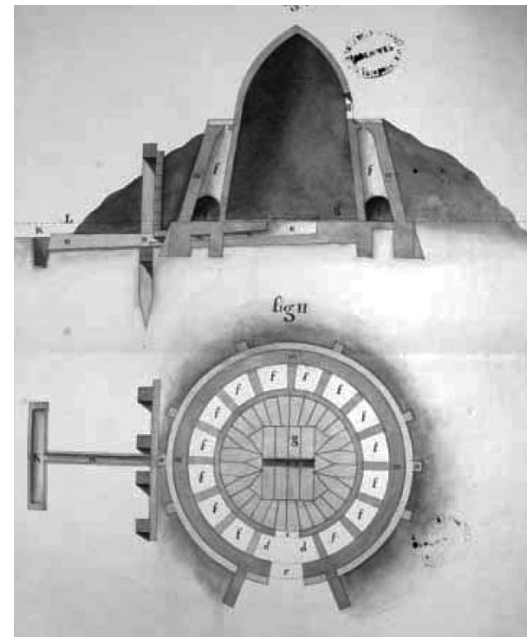


Abb. 5: J. W. Meil: Der Theerbreuner (1765). Dorn 160, SMPK.

Borová smola / dehet

Borová smola / dehet

Dvouplášťových komorové pece



Borová smola

Za přístupu kyslíku

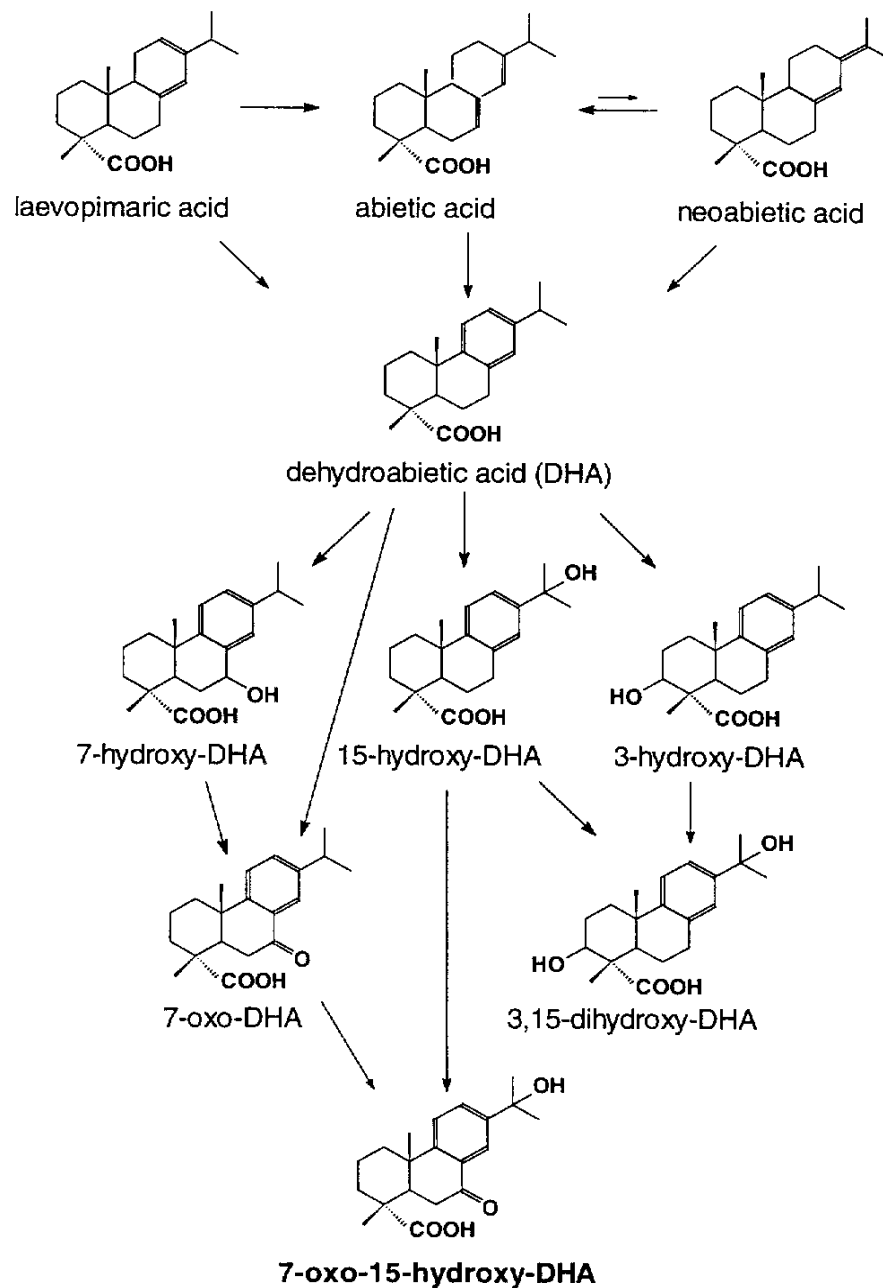
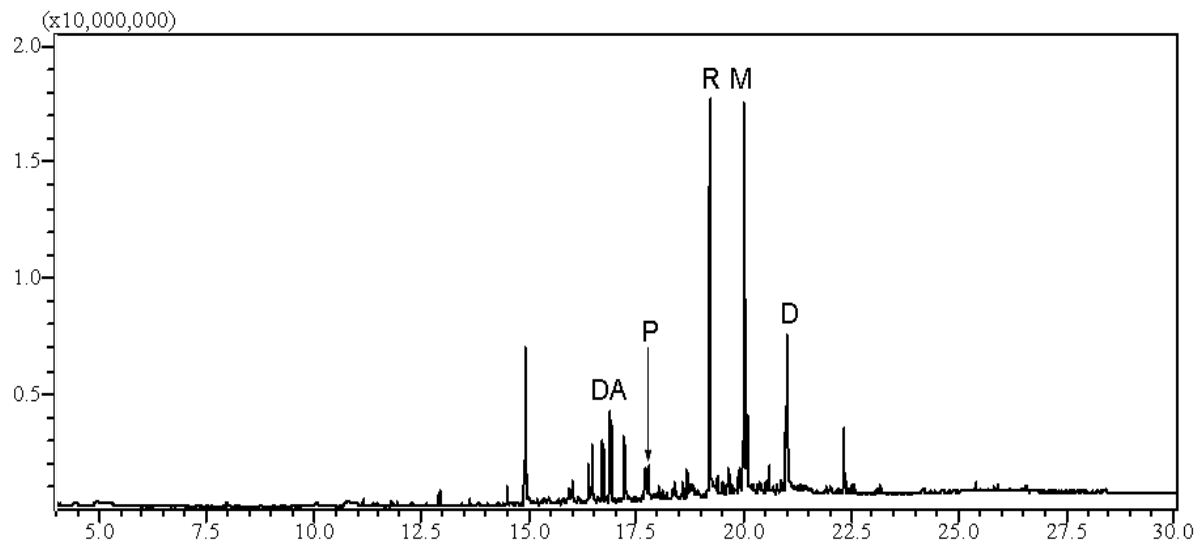


Fig. 2. Oxidation scheme of abietanes.

Výroba kolomazi

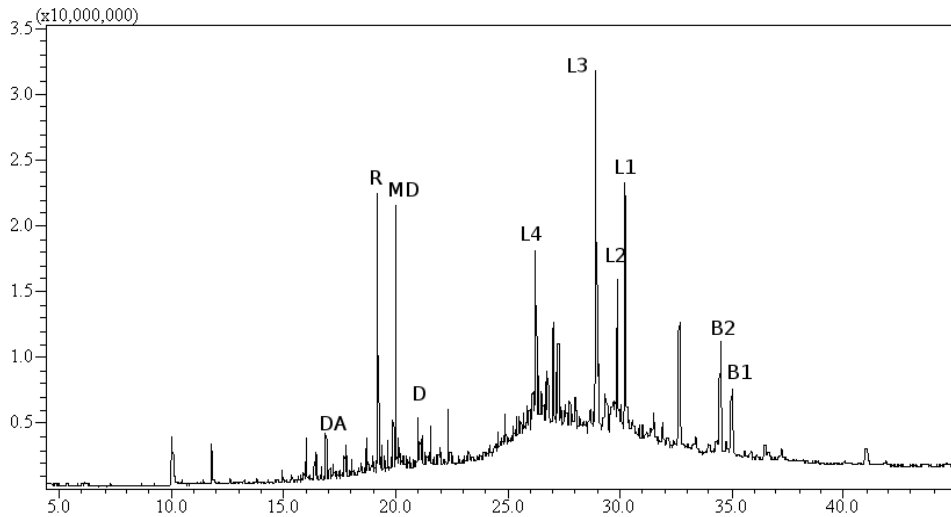
Rynartice (SZ Čechy)

Vzorek hmoty ze dna rozkladné komory dehtářské pece (1. polovina 15. století)



Chromatogram (Scan mod) chloroformového extraktu vzorku z Rynartic (DA dehydroabietin, R reten, MD methyl dehydroabietát, D kyselina dehydroabietová).

Výroba kolomazi



Chromatogram (Scan mod) chloroformového extraktu vzorku z Mostku (DA dehydroabietin, R reten, MD methyl dehydroabietát, D kyselina dehydroabietová, L4 lup-2,20(29)-dien, L3 lup-2,20(29)-dien-28-ol, L2 lupenon, L1 lupeol, B2 betulon, B1 betulin).

Mostek (V Čechy)

Vzorek z vnějšího povrchu keramického fragmentu z blízkosti dehtařské pece (14. stol.)



Aplikace borového dehtu

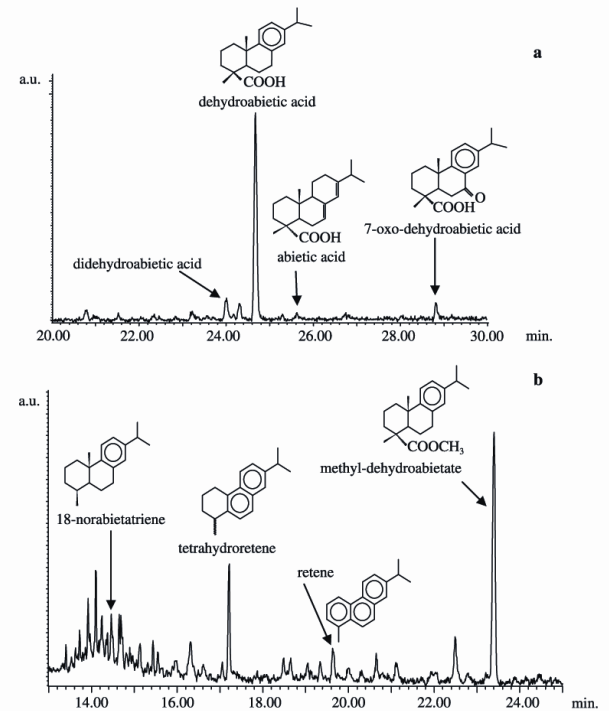
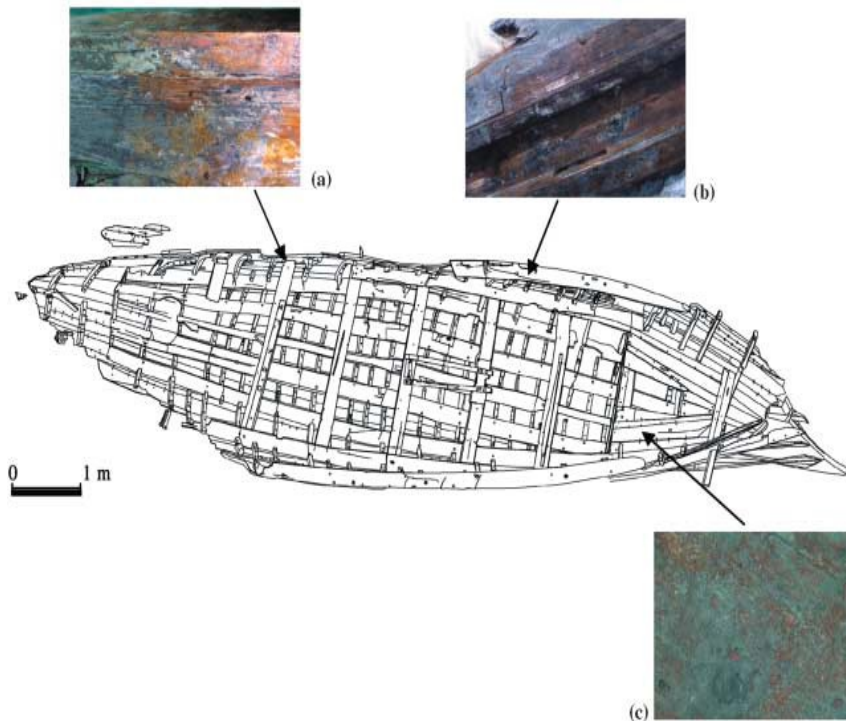


Figure 4 GC-MS chromatograms of the acidic fraction (a) (the acidic species are present as TMS esters) and of the neutral fraction (b) of sample 37 from the waterproofing materials of ship F.

Kolomaz

Příměsí

Terpentýn

Lněný olej

Lůj

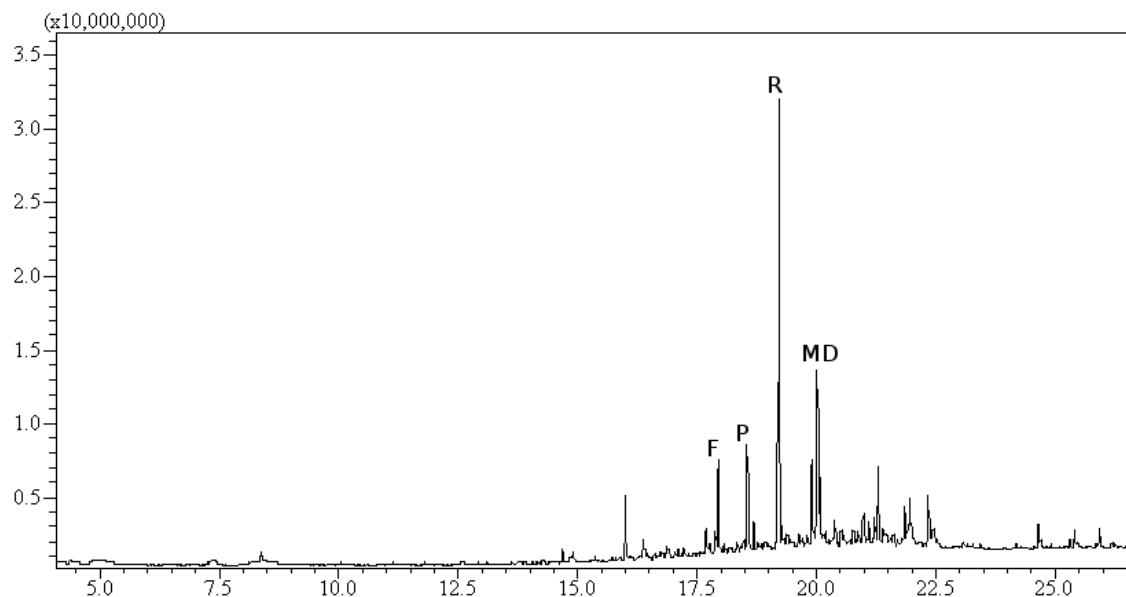


Abb. 15. Abschmieren eines Reisewagens im 15. Jahrhundert.

Nach S. Brant, *Das Narrenschiff* (1494). Photo: Deutsches Museum, München



Analýza pyrolýzních produktů



archeologický výzkum
domu čp. 308 v Táboře
(15. Století).

Chromatogram (Scan mod) chloroformového extraktu
vzorku z komorového kachle z Tábora (F fluoranthen, P
pyren, R reten, MD methyl dehydroabietát).



Destilace terpentýnu

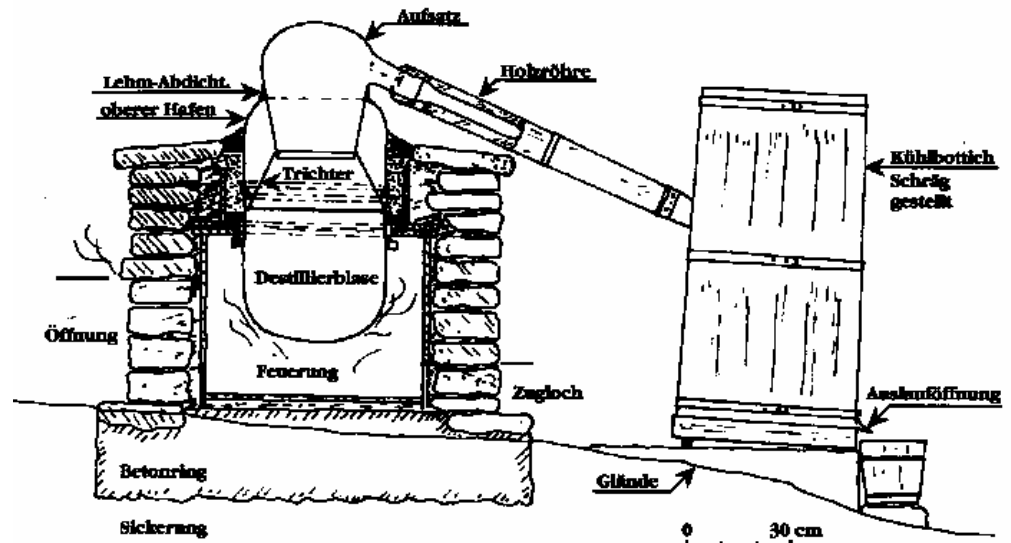
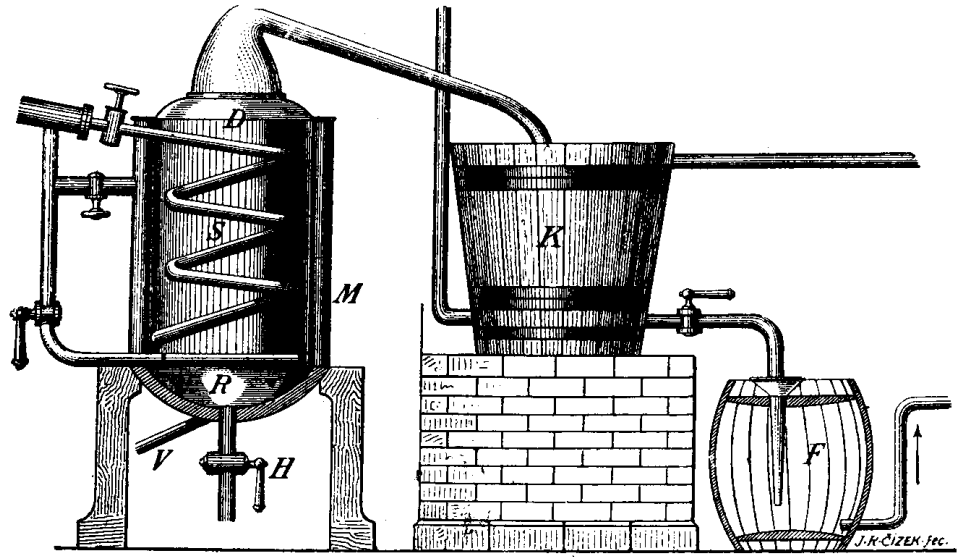
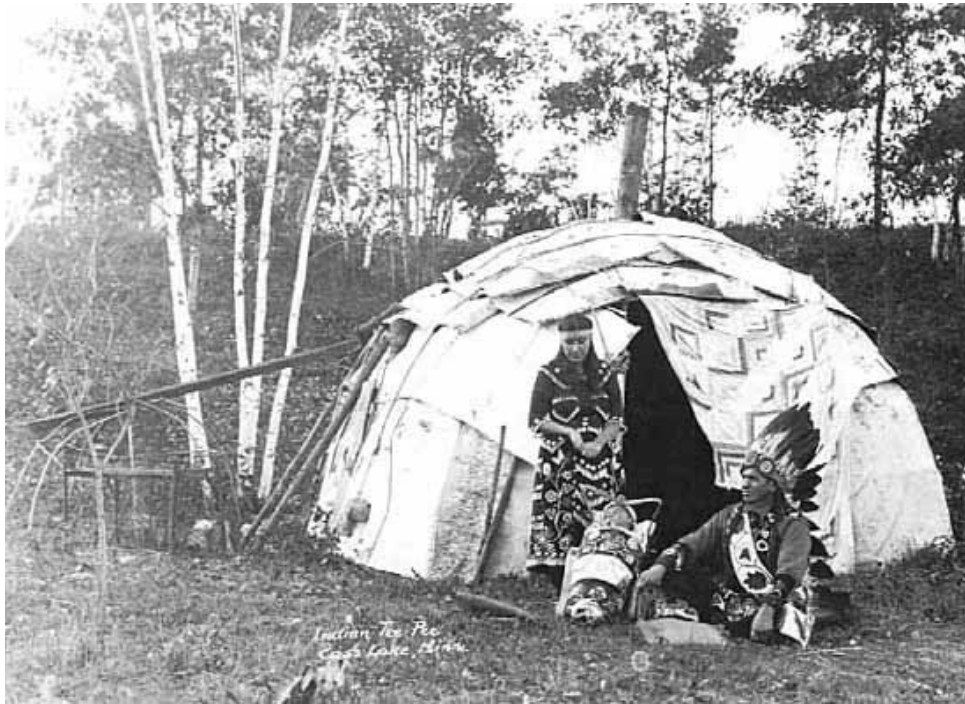
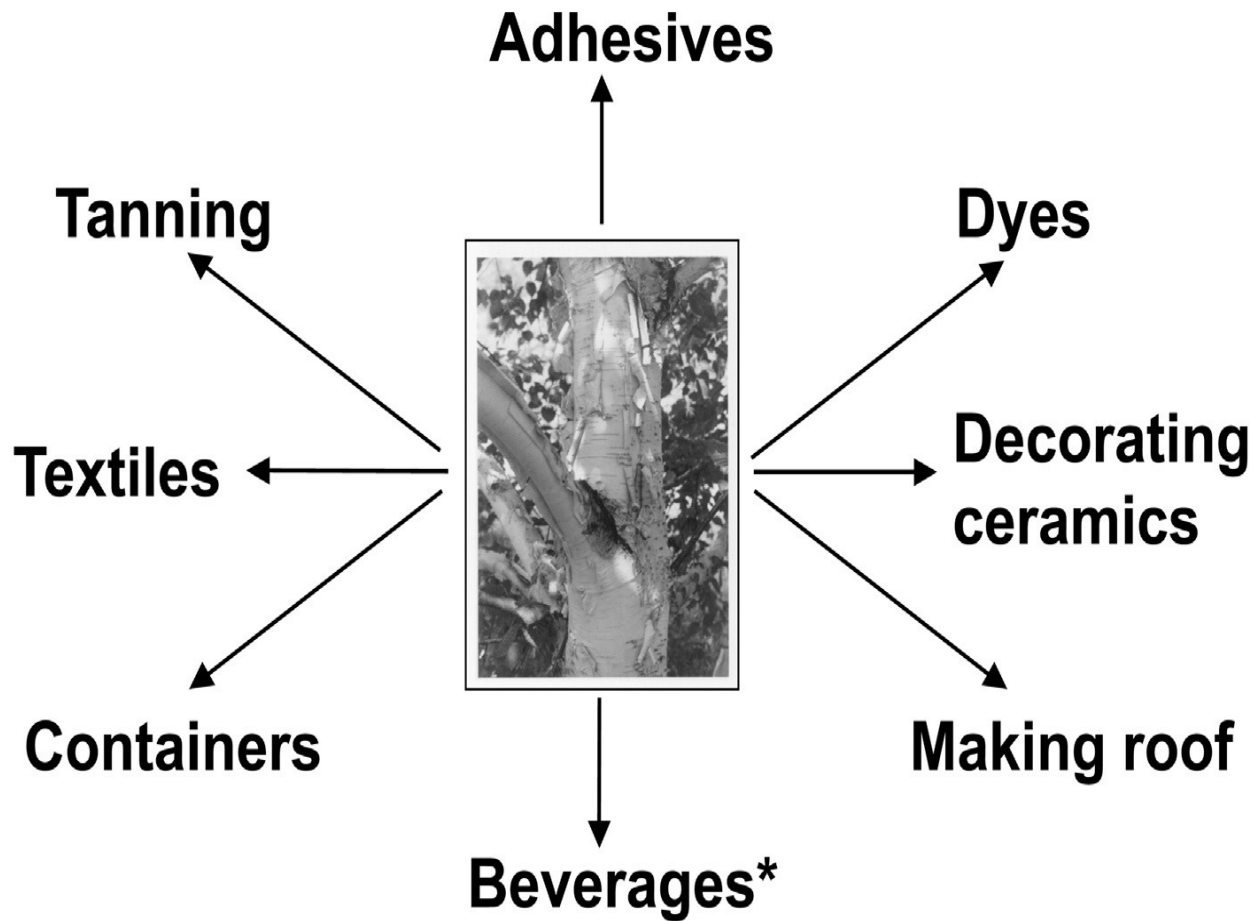


Abb. 1. Wagenschmiedofen, Standort Amesberg. Zeichnung: H. Frank

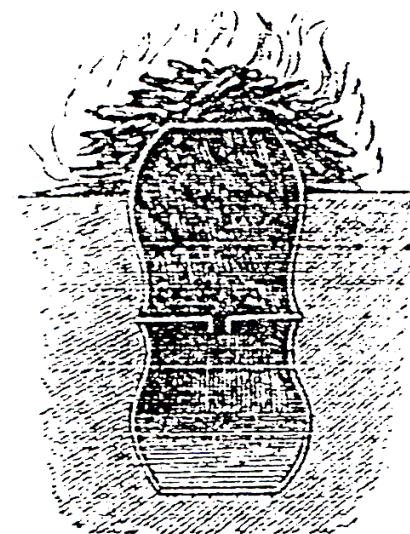
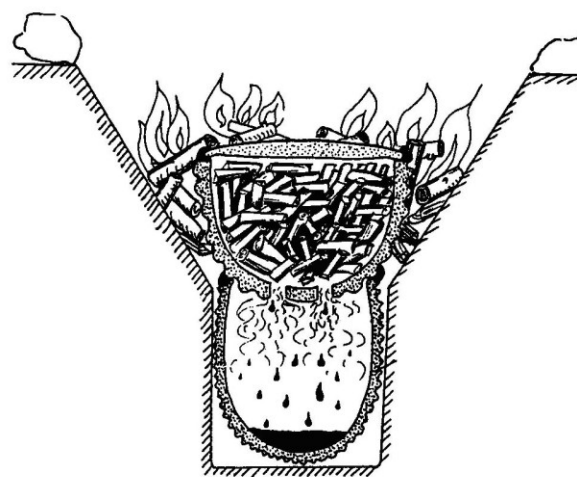
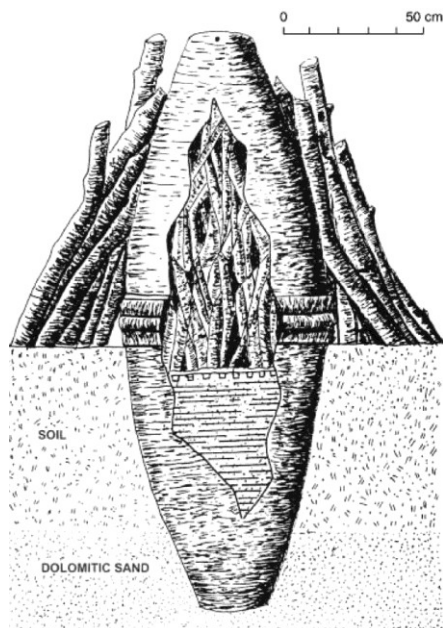
Březová smola / dehet



Březová smola / dehet

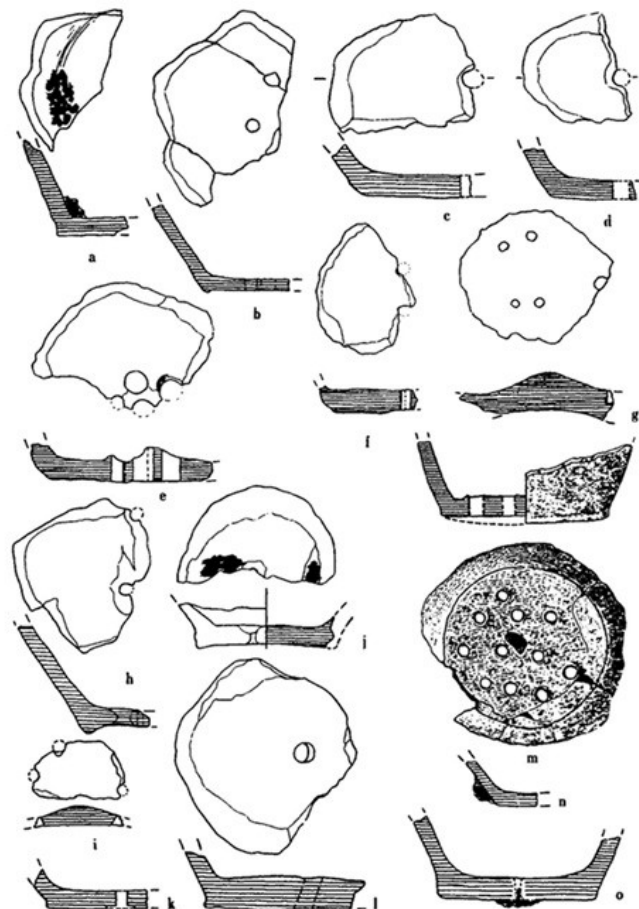
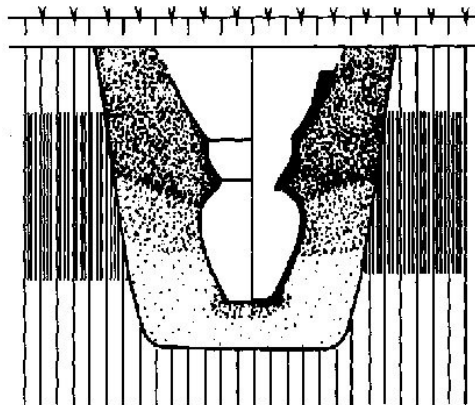
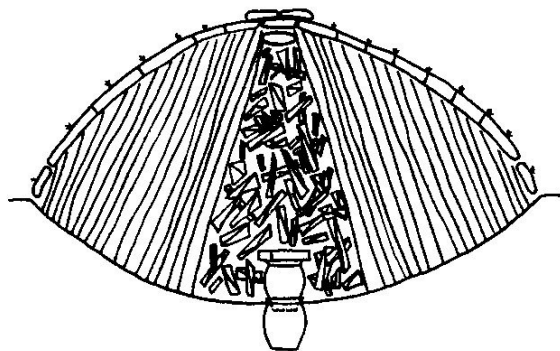


Březová smola / dehet



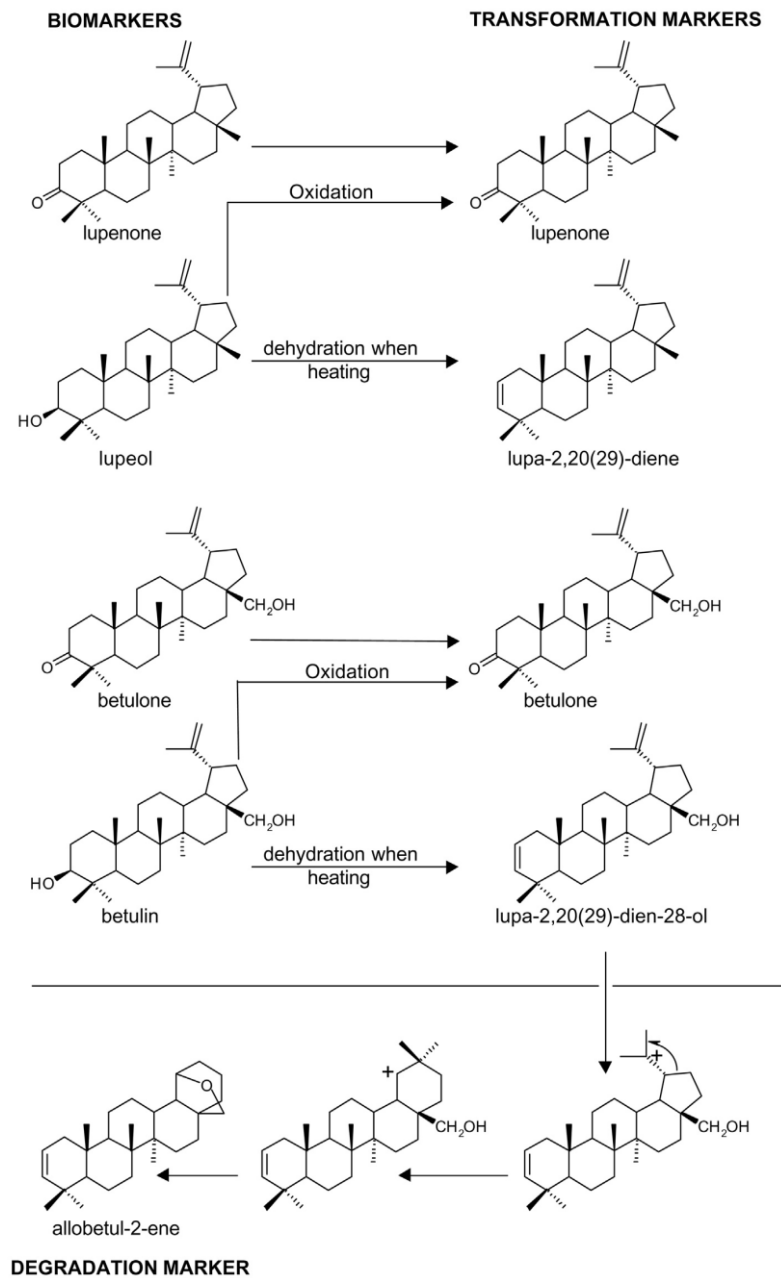
Různé varianty metody dvou nádob

Březová smola / dehet



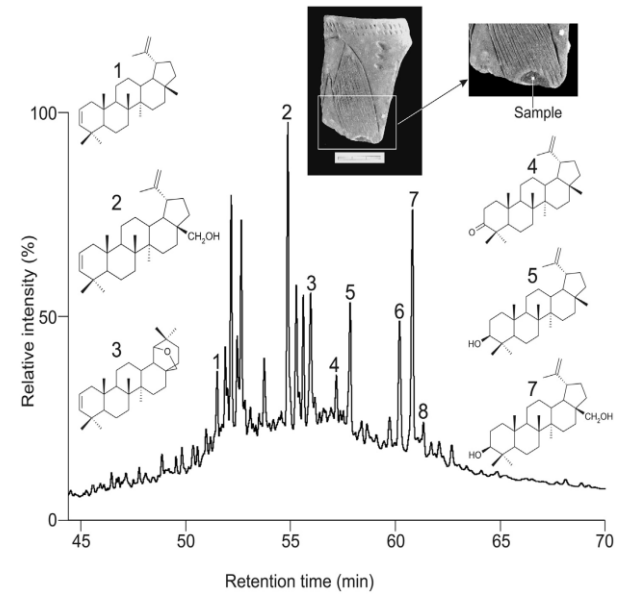
Pozůstatky nádob s perforovaným dnem (Meklenbursko), způsob jejich použití a pravděpodobný archeologický doklad.

Březová smola / dehet



Březová smola / dehet

Aplikace





Bohatý pohřeb východní halštatské kultury
(cca 600 b.c., ml. doba železná),
Langenlebar, Ldkr. Tulln, Dolní Rakousko,

Směsi s lipidy (plastifikátory)

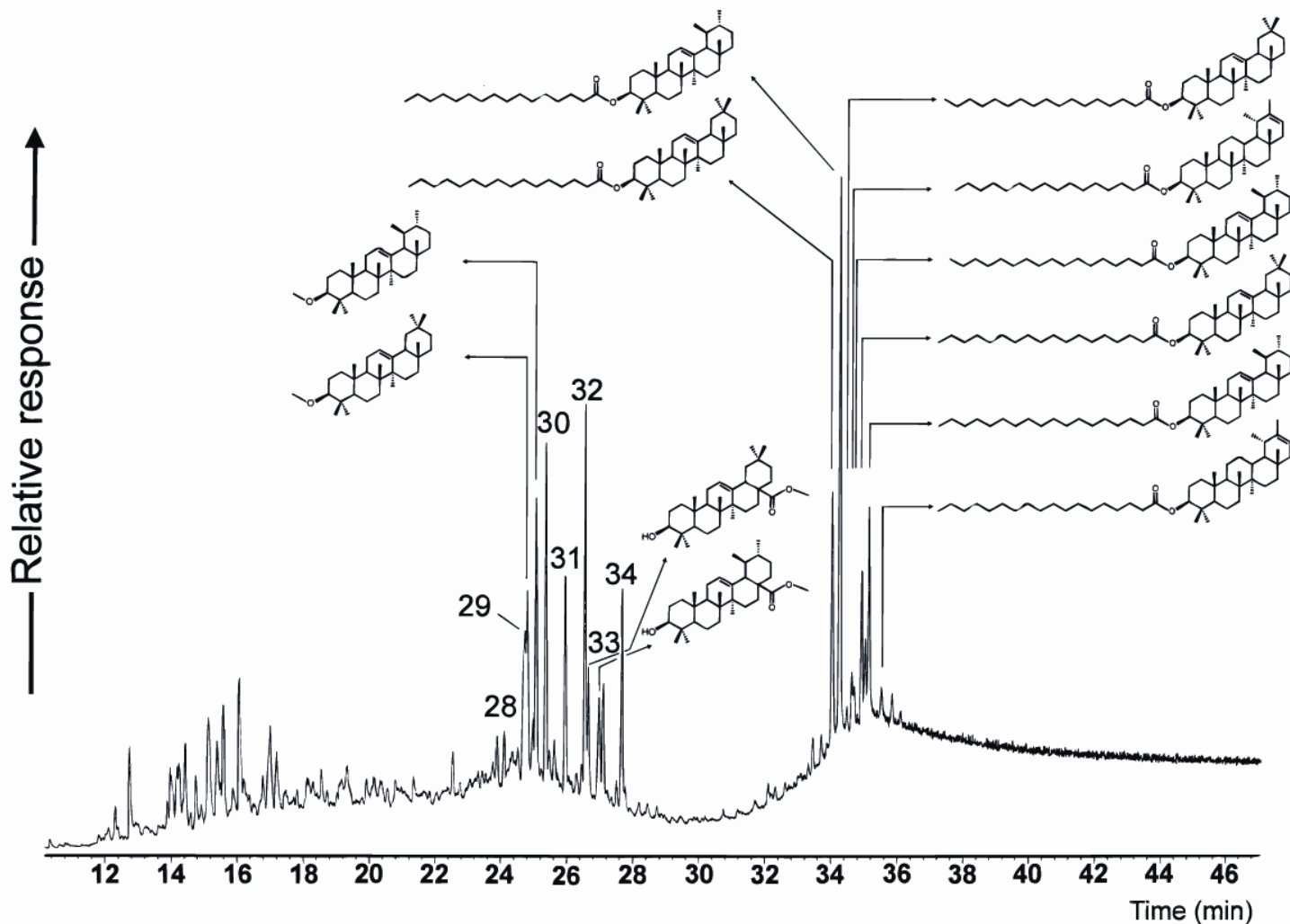
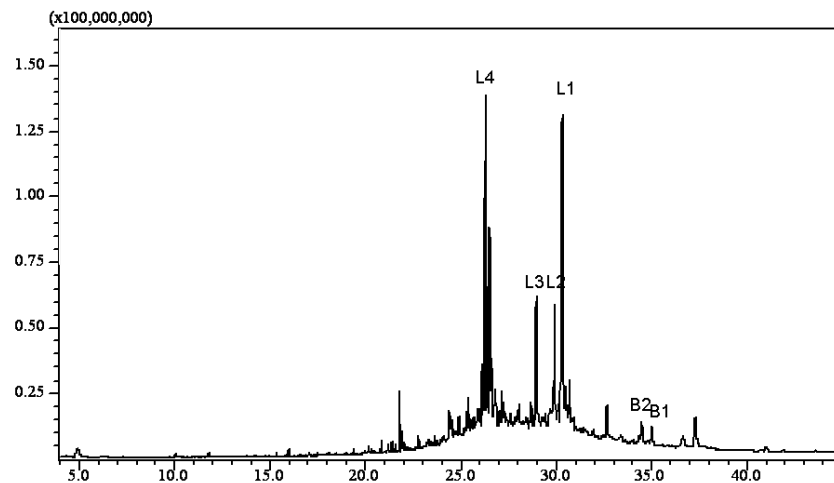
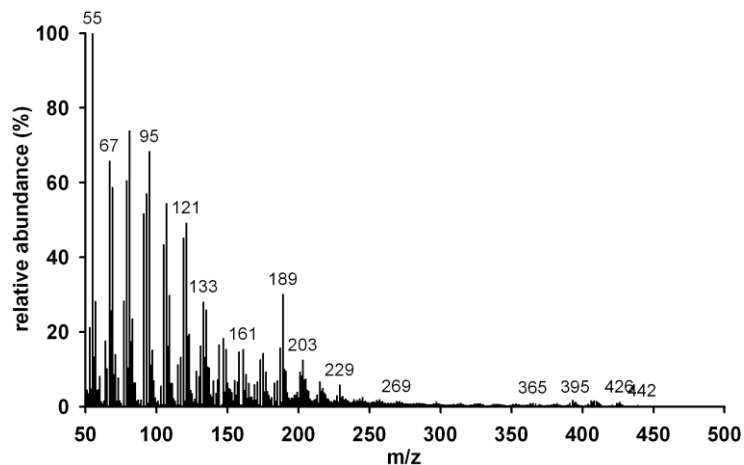


Figure 1. Representative HTHRGC/MS total ion current trace of the ester fraction from smoke particle extract of Castanha-do-Pará. Numbers refer to carbon chain length of free fatty acids (analyzed as the methyl esters).

Identifikace březové smoly/dehtu



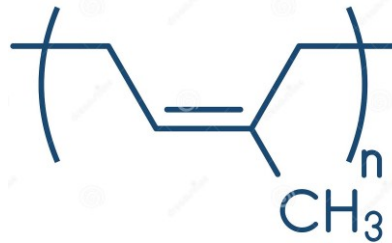
Chromatogram (Scan mod) chloroformového extraktu vzorku z Ivanovic na Hané (L4 lupan-2,20(29)-dien, L3 lupan-2,20(29)-dien-28-ol, L2 lupenon, L1 lupeol, B2 betulon, B1 betulín).

Kaučuk

Přírodní

Syntetický (1909, Německo, polyisopren)

cis-1,4-polyisopren



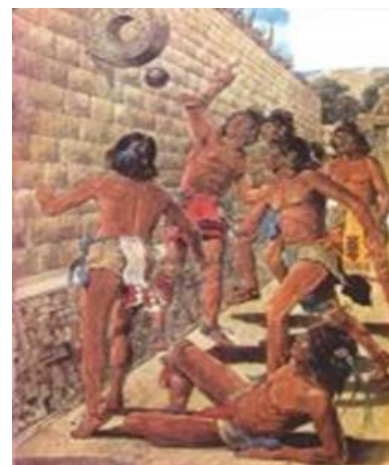
cis-polyisoprene



Hevea brasiliensis

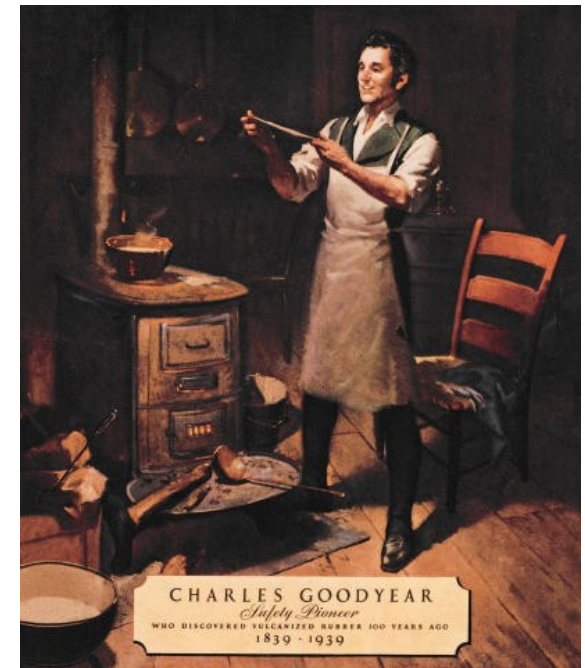
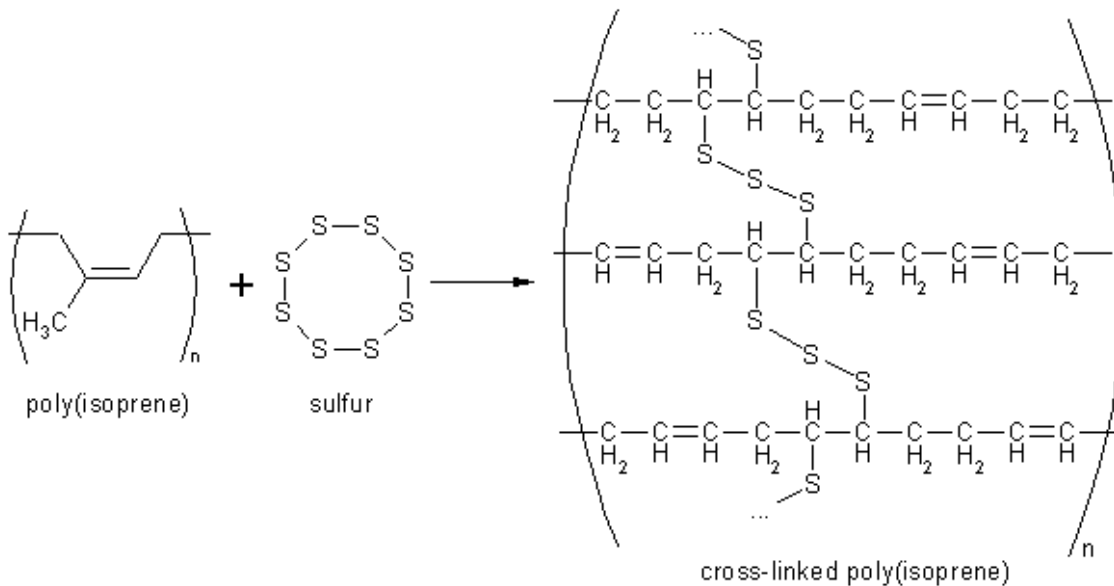


Přírodní kaučuk



Vulkanizovaný kaučuk

1844 Charles Goodyear

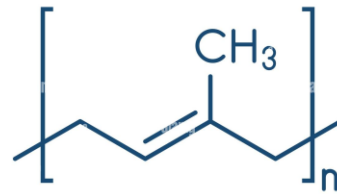
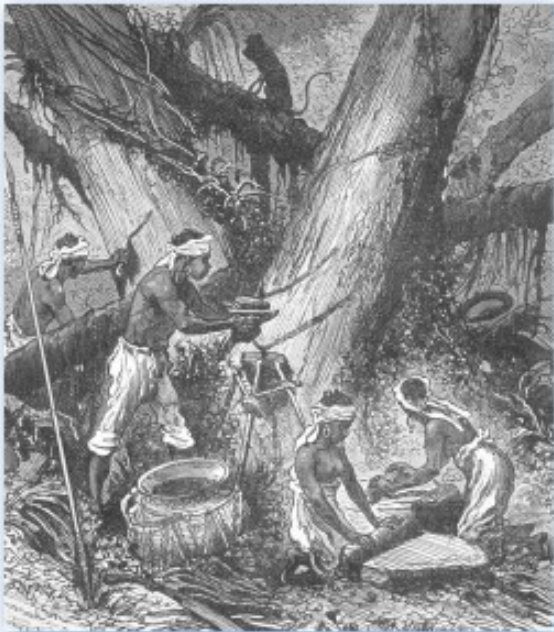


Ebonit = přírodní nebo syntetický kaučuk vulkanizovaný vysokým procentem síry.

Gutaperča

Od roku 1840

trans-1,4-polyisopren



trans-polyisoprene



Palaquium gutta

JV Asie (Malajsie)

Balata

Získává se ze stromu *Manilkara bidentata* v Guyaně a Západní Indii.

Stejně jako gutaperča je balata nepružná, houževnatá, kožovitá a odolná vůči vodě a při zahřátí měkne. Často se používá jako náhrada dražší gutaperči, zejména při výrobě golfových míčků a strojních pásů.



Uhlí

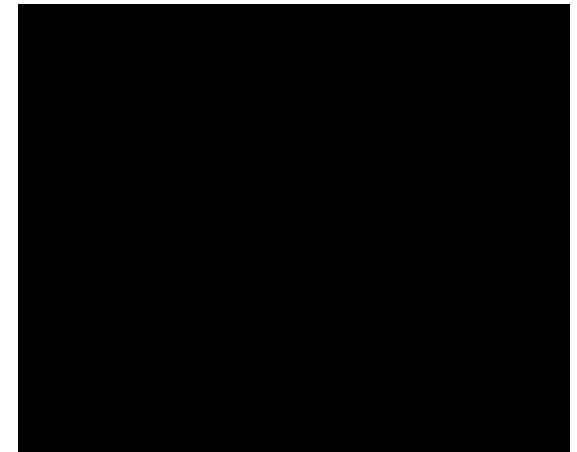
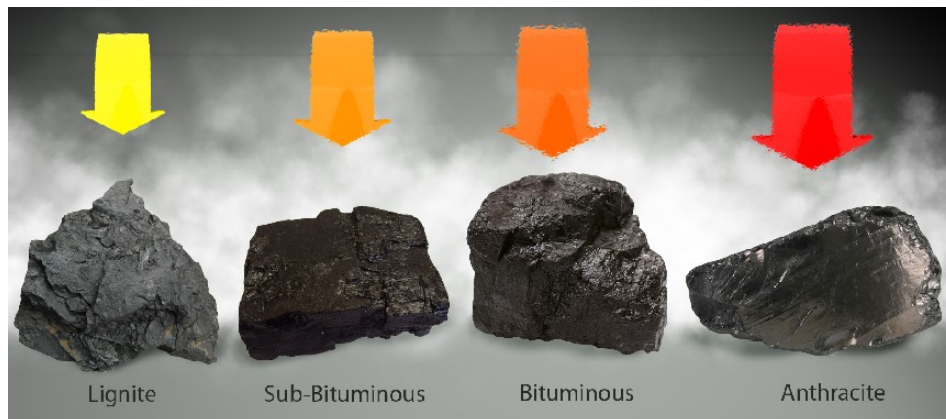
je hnědá, černá nebo hnědo-černá hořlavá hornina. Několik druhů podle obsahu uhlíku v něm – čím méně uhlíku, tím nižší kvalita a efektivita.

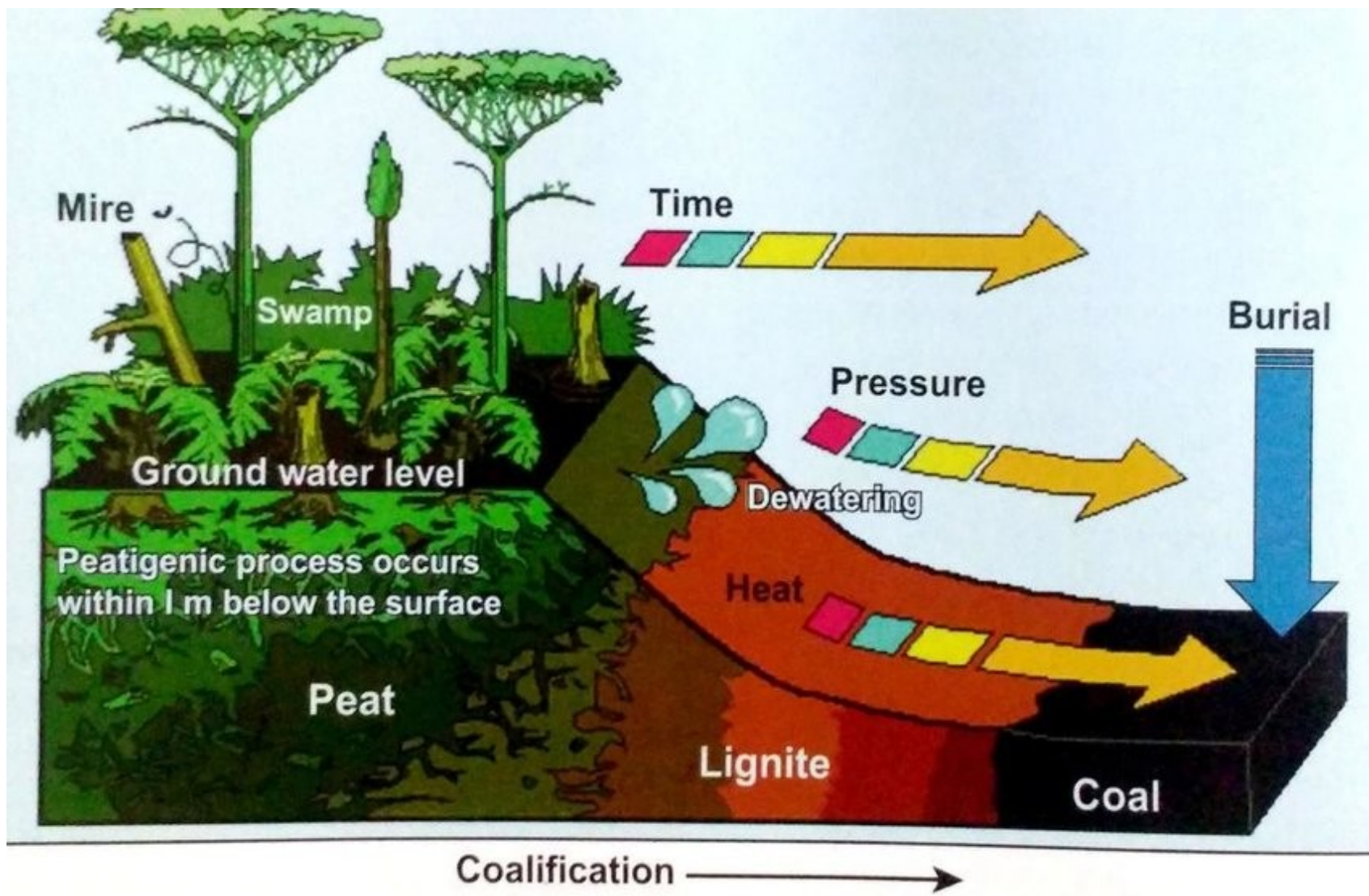
Lignit – je nejméně kvalitní druh uhlí. Užívá se výhradně pro výrobu elektřiny nebo výrobu technologického tepla. Je třetihorního původu, má v sobě přibližně 60 % uhlíku.

Hnědé uhlí – používá se k vytápění domácností nebo k výrobě tepla a elektřiny. Má v sobě přibližně 80 % uhlíku. Těží se především povrchově.

Černé uhlí – má vysokou hustotu, jeho barva je obvykle černá až hnědočerná. Uhlí je prvohorního a druhohorního původu.

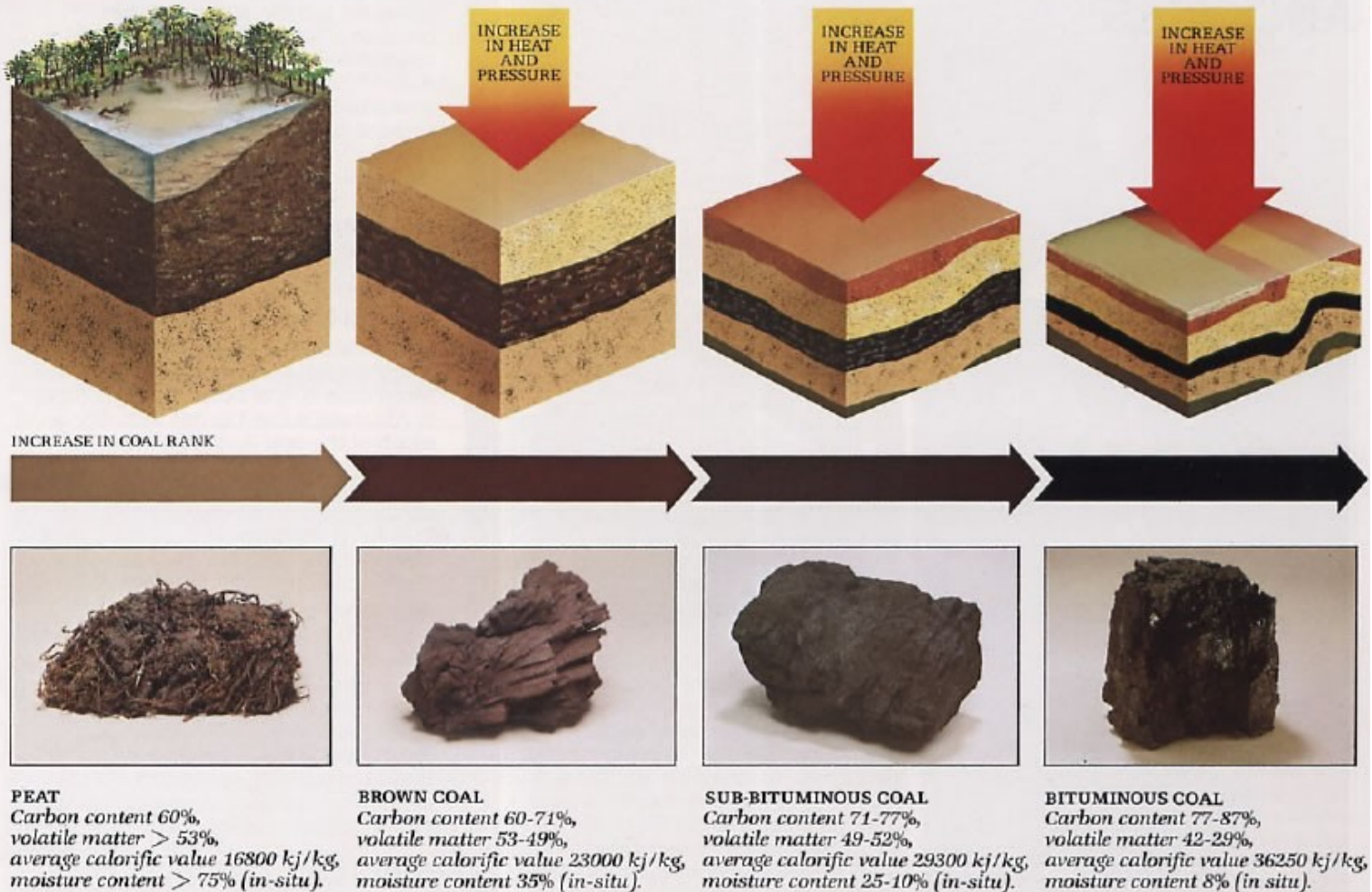
Antracit – jde o nejkvalitnější černé uhlí, používá se na vytápění a k výrobě chemikálií. Obsahuje více než 90 % uhlíku.





Vznik uhlí

CHANGES IN RANK OF COAL



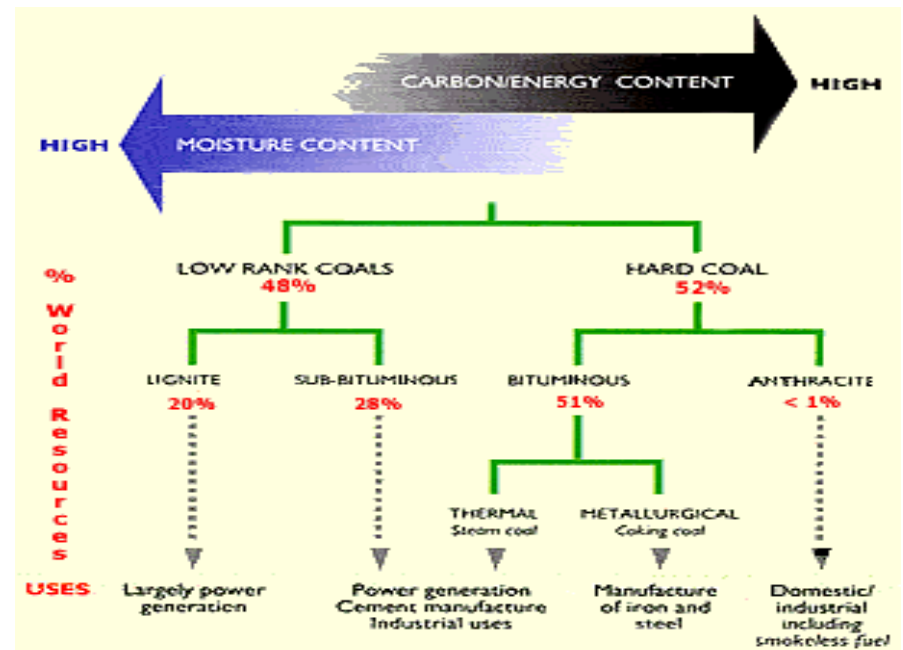
Těžba a použití uhlí

Od doby průmyslové revoluce je uhlí především důležitou energetickou surovinou. Velká část světové výroby elektřiny (40 %) využívá spalování uhlí, které probíhá v klasických uhelných respektive v tepelných elektrárnách. Uhlí se kromě výroby elektrické energie používá také k vytápění a ohřevu vody (výroba technologického tepla), uhlí je také velmi cennou primární surovinou pro mnoho odvětví chemického průmyslu.

- Černé (kamenné): výroba koksu
- Hnědé: palivo, výroba syntézního plynu
- Lignit: palivo
- Rašelina: palivo

Elementární složení ropy a uhlí

	C	H	O	S	N
Černé uhlí	87-91	4,2-5	2-6	0,5-1,5	1,2-1,8
Hnědé uhlí	73-80	5-8	10-16	1-4	0,3-0,6
Ropa lehká	85	14	0,3	0,1-0,5	0,06
Ropa střední	84,6	12,9	0,6	1,5	0,6
Ropa těžká	83-84	11	1-2	3-5	0,8

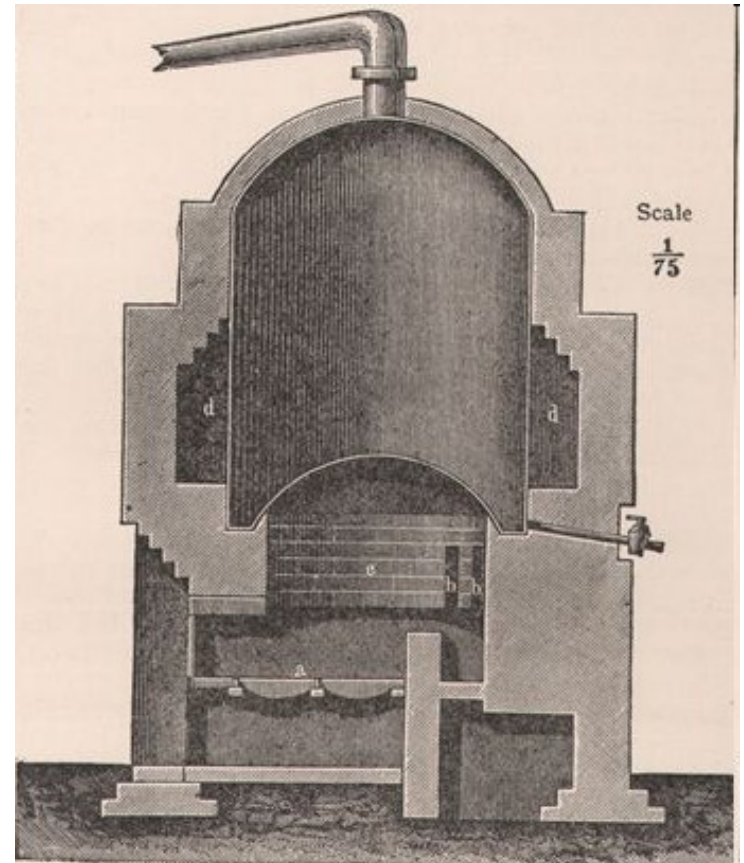


Kamenouhelný dehet

Suchou destilací černého uhlí (výroba koksu)



Uhelný kreosot, kreosotový olej



Kamenouhelný dehet

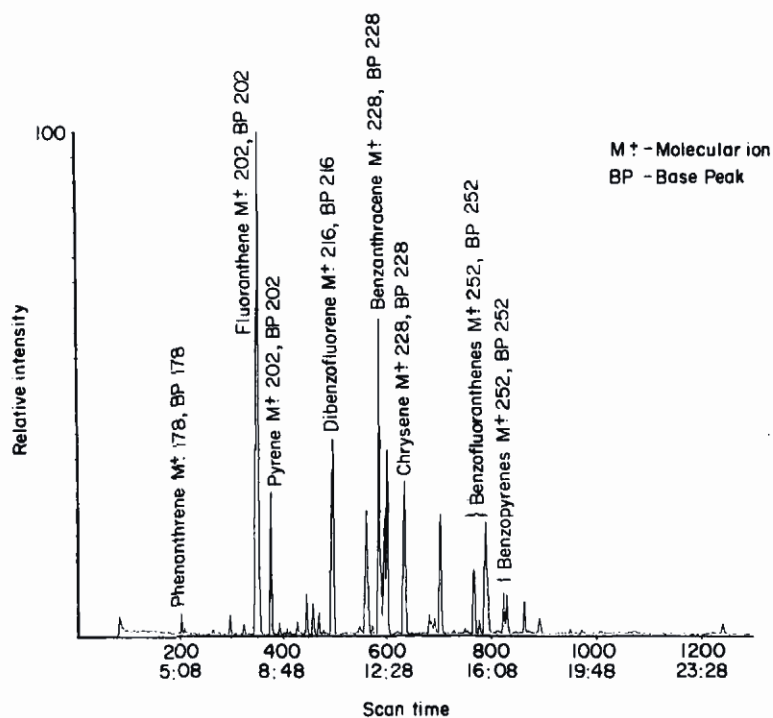
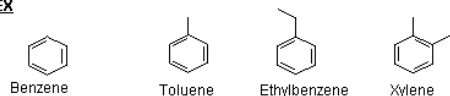


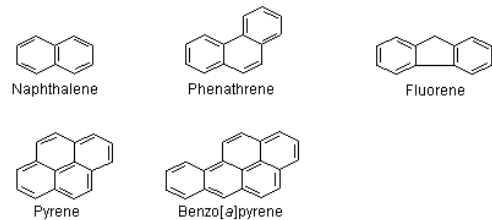
Figure 1. Total ion current (TIC) chromatogram given by the solvent washing of caulking material from the Tredunnoc boat.

Aromatic Hydrocarbons

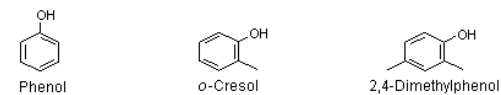
BTEX



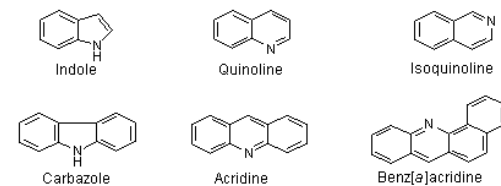
Non-heterocyclic PAHs



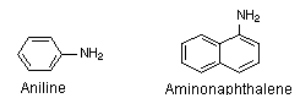
Tar Acids / Phenolics



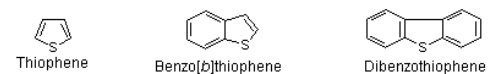
Tar Bases / Nitrogen-containing Heterocycles



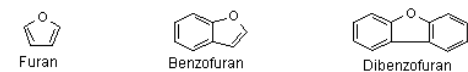
Aromatic Amines



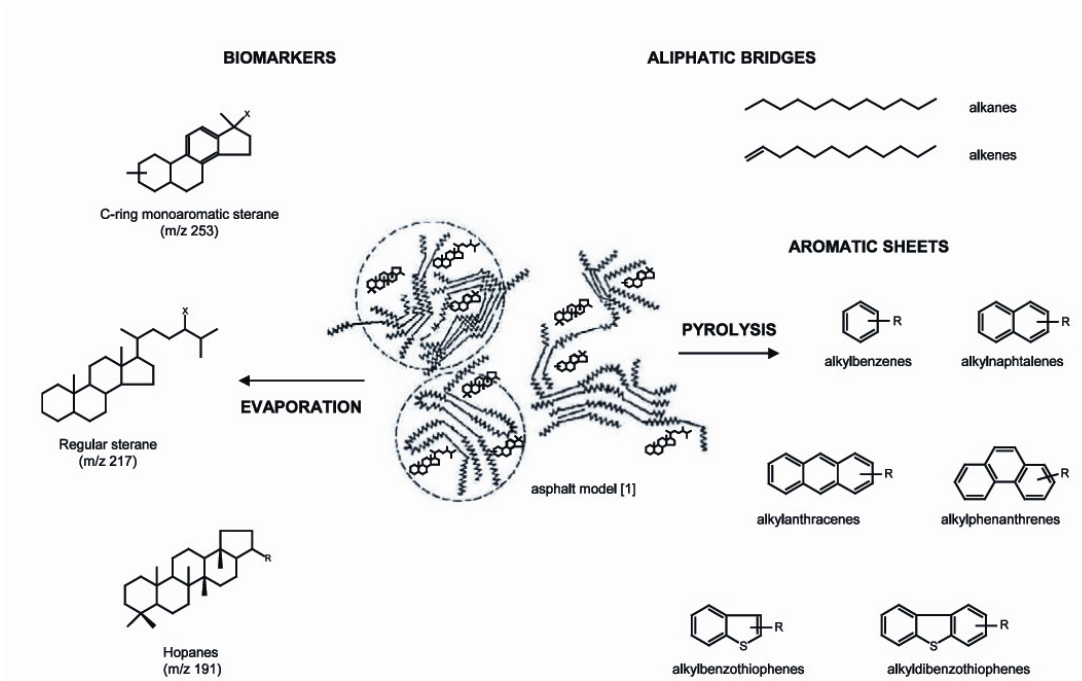
Sulfur-containing Heterocycles



Oxygen-containing Heterocycles



Bitumen, asfalt



Scheme 1. Structures of specific asphalt markers and biomarkers.

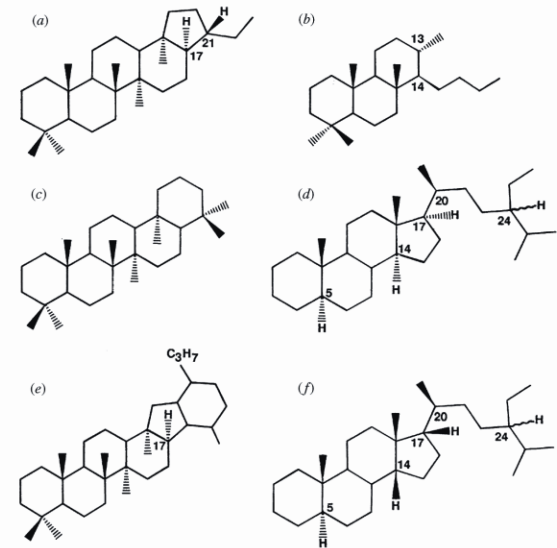


Figure 2. Molecular structures of some typical biomarkers found in the C_{15s} alkane fraction. Steranes are represented by (d) $5\alpha(H)$, $14\alpha(H)$, $17\alpha(H)$ -20S-24-ethylcholestane (abbreviated to 29 $\alpha\alpha\alpha$ S) and (f) $5\alpha(H)$, $14\beta(H)$, $17\beta(H)$ -20S-24-ethylcholestane (abbreviated to 29 $\alpha\beta$ S). (b) C_{27} - $13\beta(H)$, $14\alpha(H)$ -tricyclopolyprylene (abbreviated to 23/3) is generally the

Bitumen

Table 1. *Main use of bitumen in antiquity and prehistory*

use of bitumen	examples	excavations with examples studied
mortars in construction building	temples, palaces, terraces, floors, ziggurats, door threshold, courtyard	Mari, Babylon, Larsa, Haradum, Qal'at al-Bahrain, Mleiha, Failaka
waterproofing agent	mats, baskets, jars, water reserves, bathrooms, water pipes, cisterns, boats, sarcophagi	Tell es-Sawwan, Tell el'Oueili, Qal'at al-Bahrain, Saar, Baghdad, Ra's al-Junayz, Susa, Failaka, Tell Brak
adhesive and glue	sickles, tool handles, statues, jars, decoration (game, lyre, temple, pillar, ostrich egg)	Tell Atij, Netiv Hagdud, Umm El Tlel, Mari, Tell Halula, Ras Shamra, Susa
domestic artefacts	spindle whorls, balls, dice, wall cones	Tell el'Oueili, Failaka, Saar?, Qal'at al-Bahrain, Susa, Tell Brak
jewellery	bead, ring, gold badges on clothing or for horse harnesses	Umm al-Qaiwwain, Ulu Burun, Susa, Saar
sculpture	sculpture, cylinder and stamp seal of Susa in bitumen mastic	Susa
mummification	mixed with conifer resin, beeswax, grease to prepare mixtures for embalming	Egyptian mummies from the Queen valley and from several Museums (Lyon, Hannover, Paris)

Bitumen



Bitumen-painted ceramics from Tell Sabi Abyad (northern Syria, cca 6000 BC)

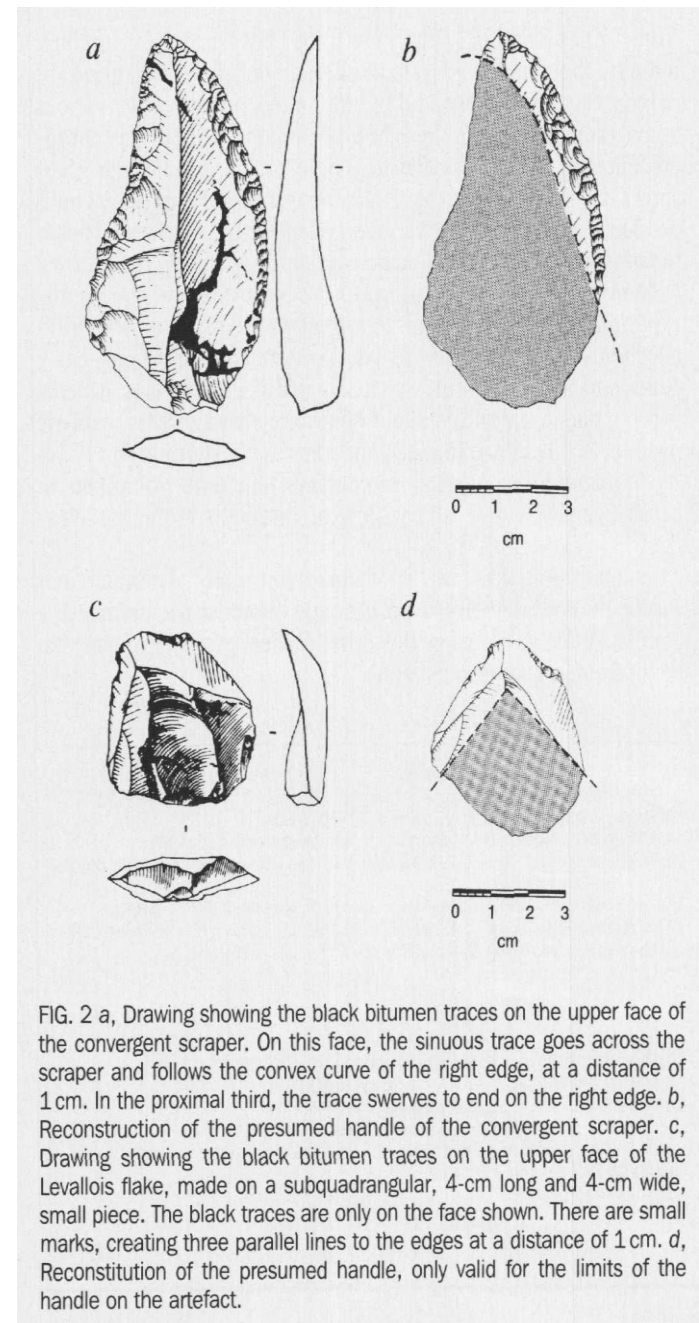
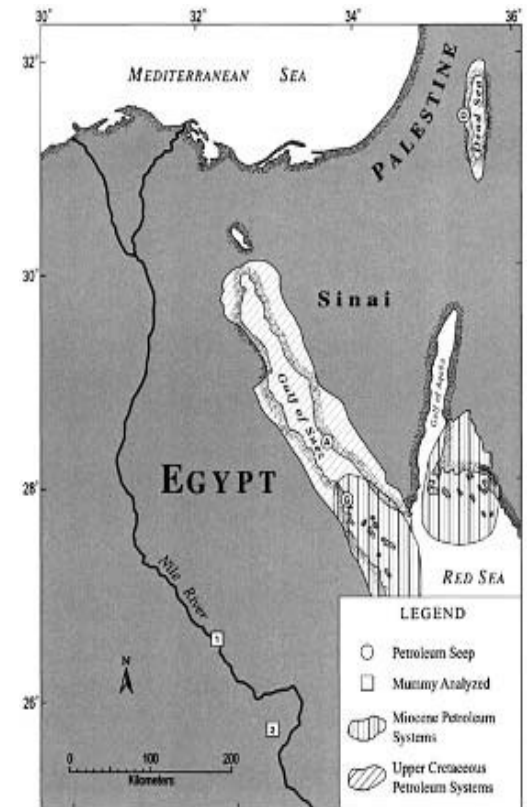
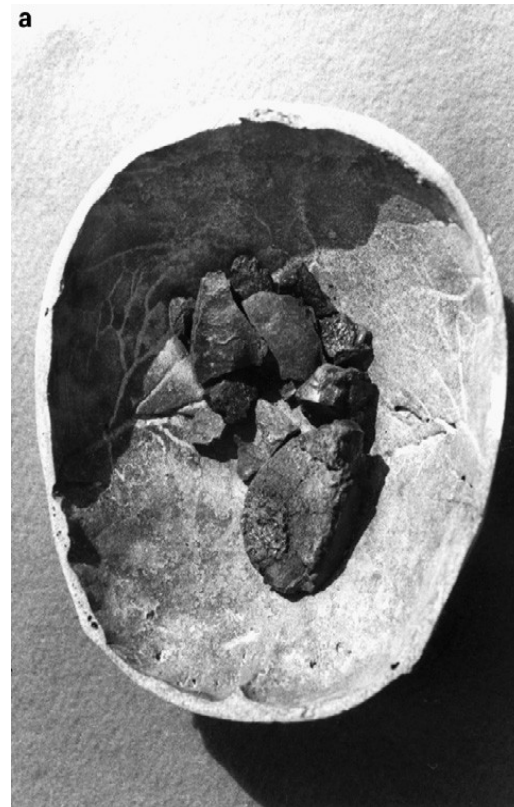
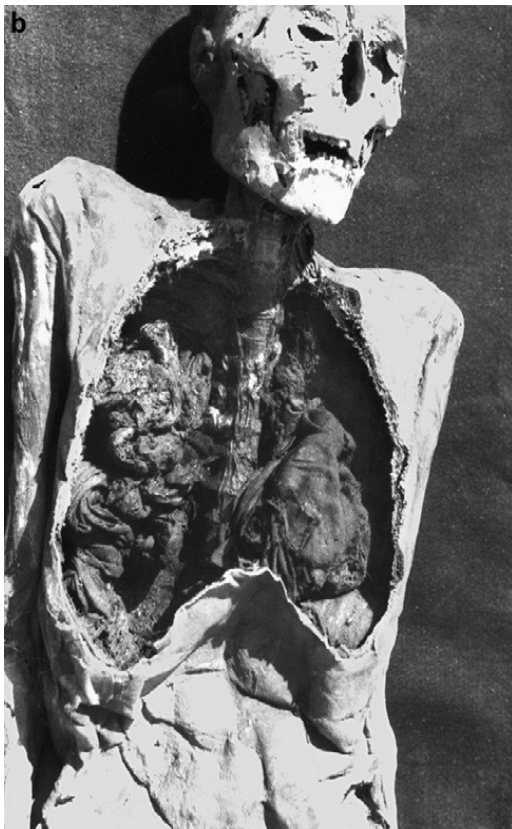


FIG. 2 a, Drawing showing the black bitumen traces on the upper face of the convergent scraper. On this face, the sinuous trace goes across the scraper and follows the convex curve of the right edge, at a distance of 1 cm. In the proximal third, the trace swerves to end on the right edge. b, Reconstruction of the presumed handle of the convergent scraper. c, Drawing showing the black bitumen traces on the upper face of the Levallois flake, made on a subquadrangular, 4-cm long and 4-cm wide, small piece. The black traces are only on the face shown. There are small marks, creating three parallel lines to the edges at a distance of 1 cm. d, Reconstitution of the presumed handle, only valid for the limits of the handle on the artefact.

Bitumen

Obrázky z pitvy mumie



Bitumen

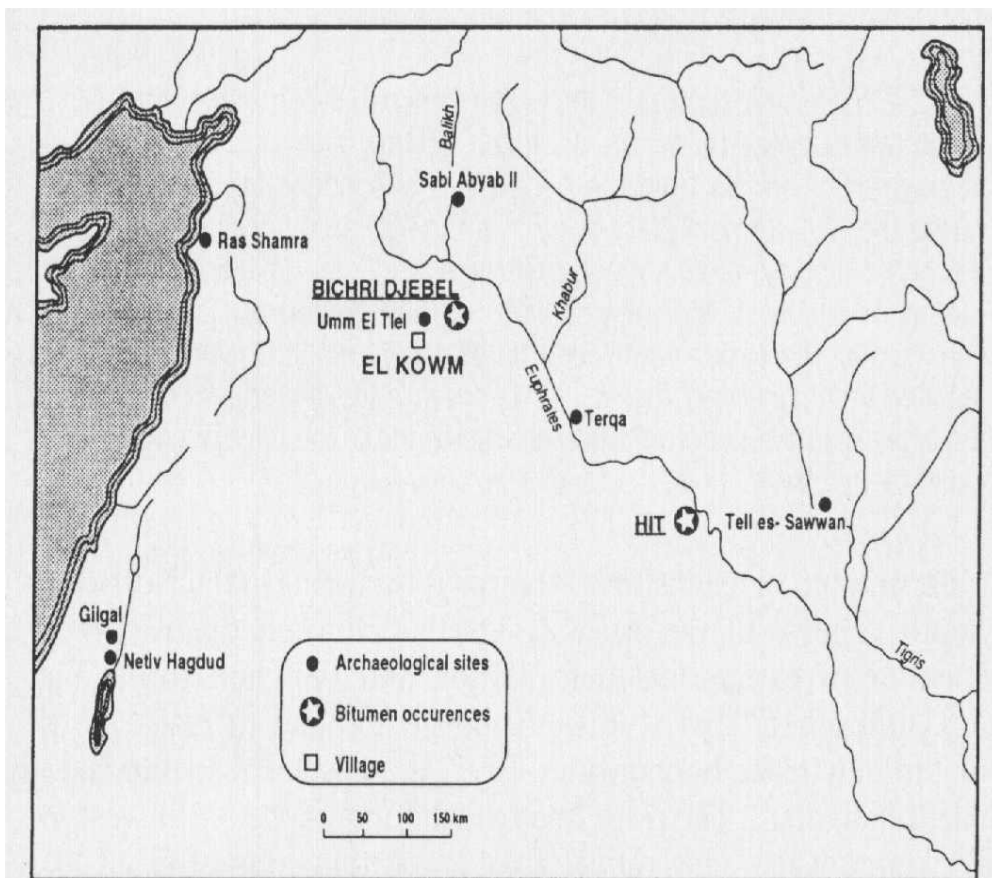


FIG. 1 Location of archaeological sites and bitumen sources.

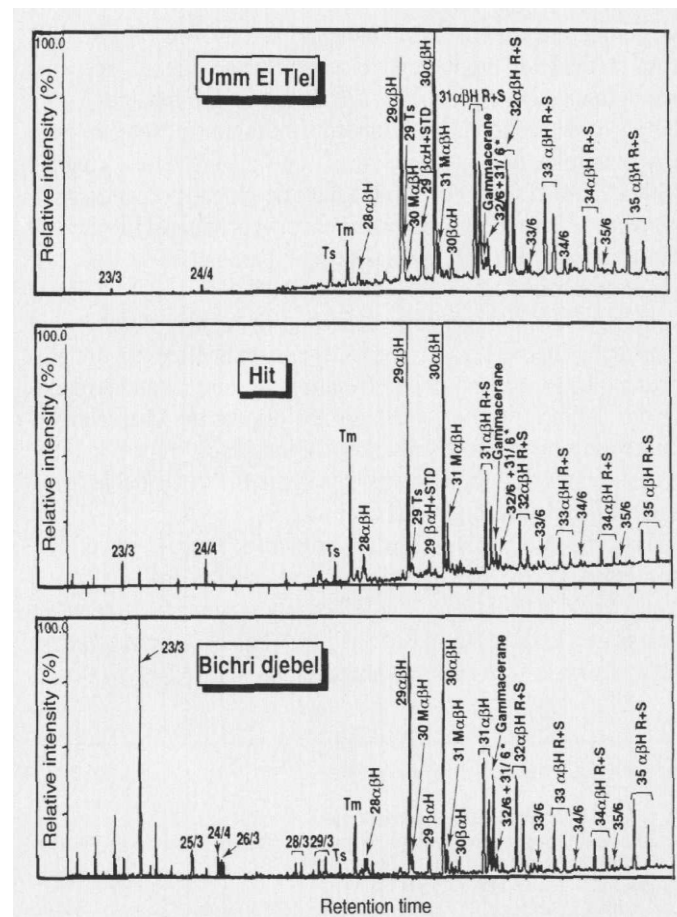


FIG. 3 Terpane distribution pattern (m/z 191) of the chloroform extract of the Umm el Tiel scraper, compared to characteristic fingerprints of two well-known natural asphalts: Abu Gir in the Bichri djebel in Syria, and Hit along the Euphrates river in Iraq. Terpanes from the Bichri djebel oil-stained sands contain significant tricyclopolyrenanes but much higher Tm-to-Ts and gammacerane-to-hopane ratios. Abbreviations: Tm, C27 $\alpha\beta$ -hopane; Ts, C27 $\alpha\beta$ -neohopane; 29 $\alpha\beta$ H, C29 $\alpha\beta$ -hopane; 30M $\alpha\beta$ H, 2 α -methyl-C29 $\alpha\beta$ -hopane; 23/3, C23 tricyclopolyrenane; 24/4, C24 tetracyclic terpane; 33/6, C33 hexahydrobenzohopane; 31/6*, the novel C31hexahydrobenzohopane, referred to as structure **6** in ref. 24.

Bitumen

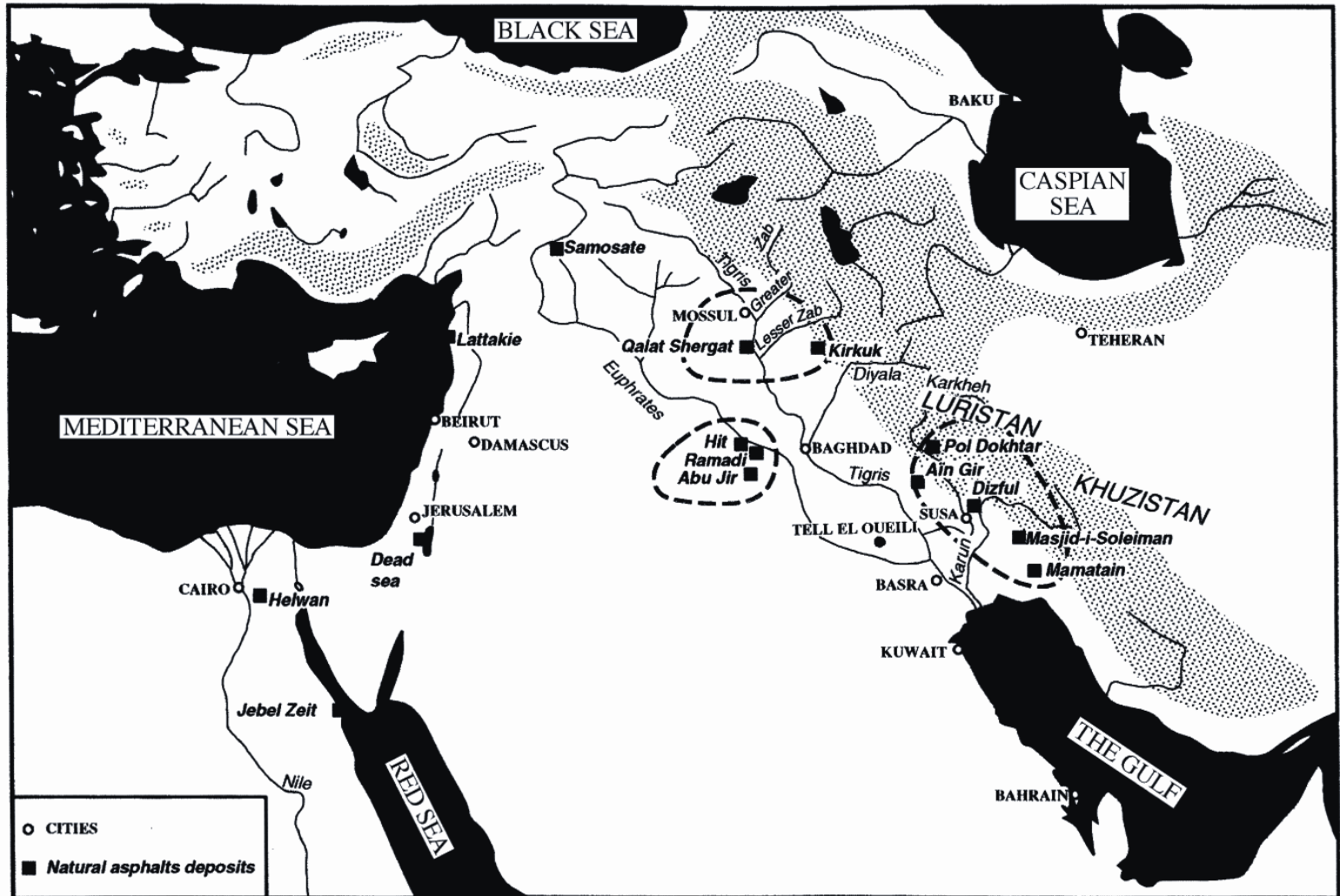
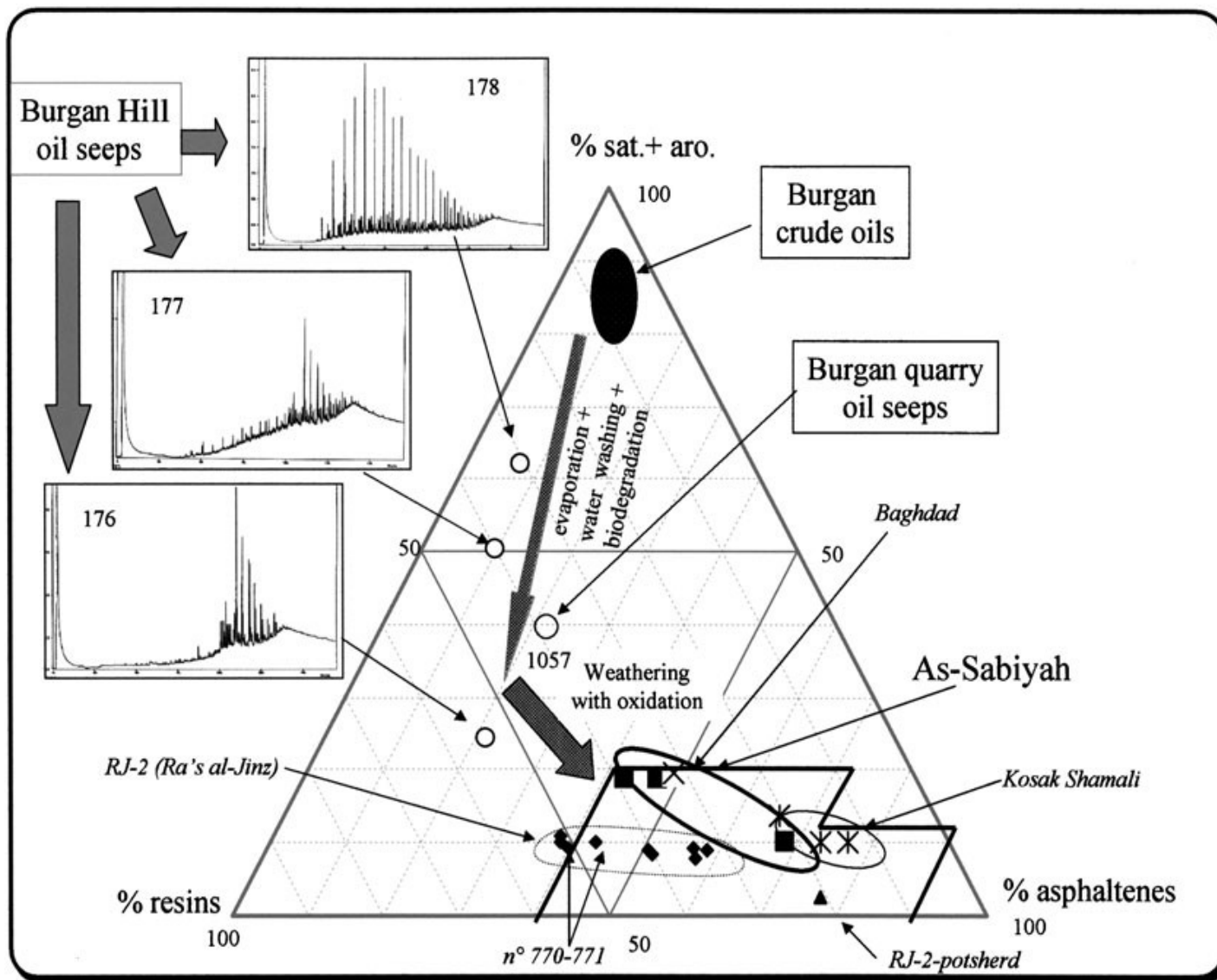


Figure 1. Map of the Near East showing the locations of the major natural asphalt deposits (e.g. Hit-Abu Jir, Dead Sea, Kirkuk, etc.).



Ternární diagram hrubého složení organických látek extrahovaných chloroformem nebo dichlormethanem ("nasycené + aromatické látky", "pryskyřice" a "asfalteny"), který poskytuje srovnání mezi vzorky bitumenu z As-Sabiyah, Ra's al-Jinz, Bagdádu a Kosak Shamali a ropnými průsaky a surovou ropou z Burganu (Kuvajt).

Bitumen

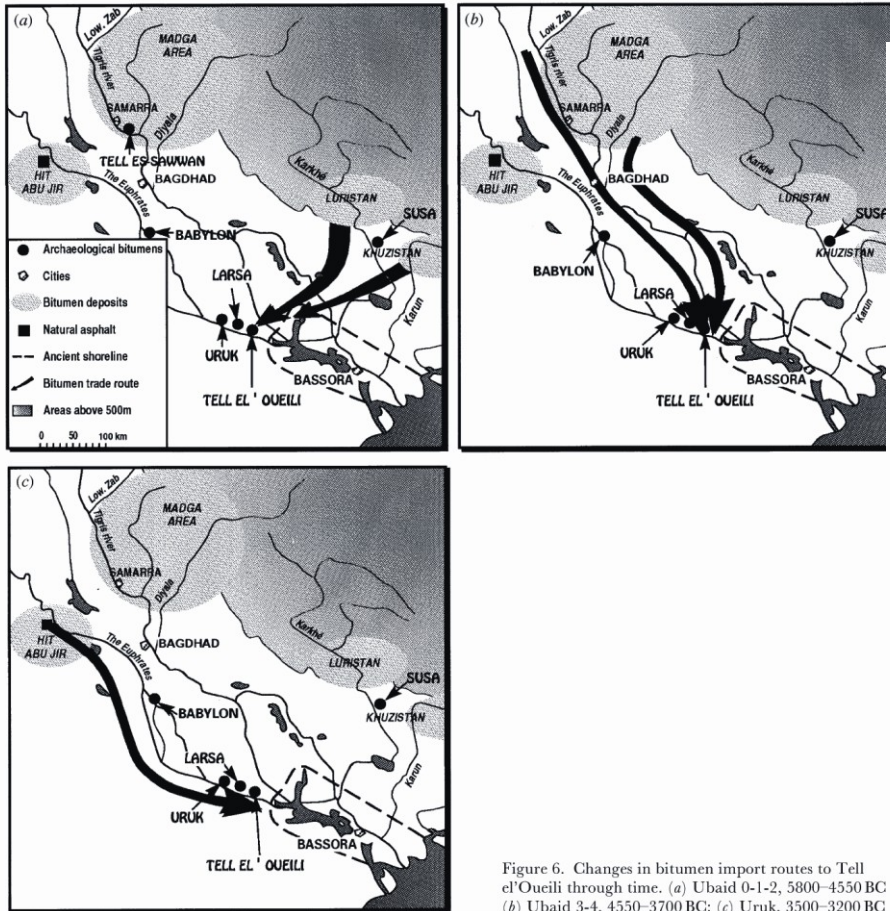


Figure 6. Changes in bitumen import routes to Tell el'Oueili through time. (a) Ubaid 0-1-2, 5800-4550 BC (b) Ubaid 3-4, 4550-3700 BC; (c) Uruk, 3500-3200 BC

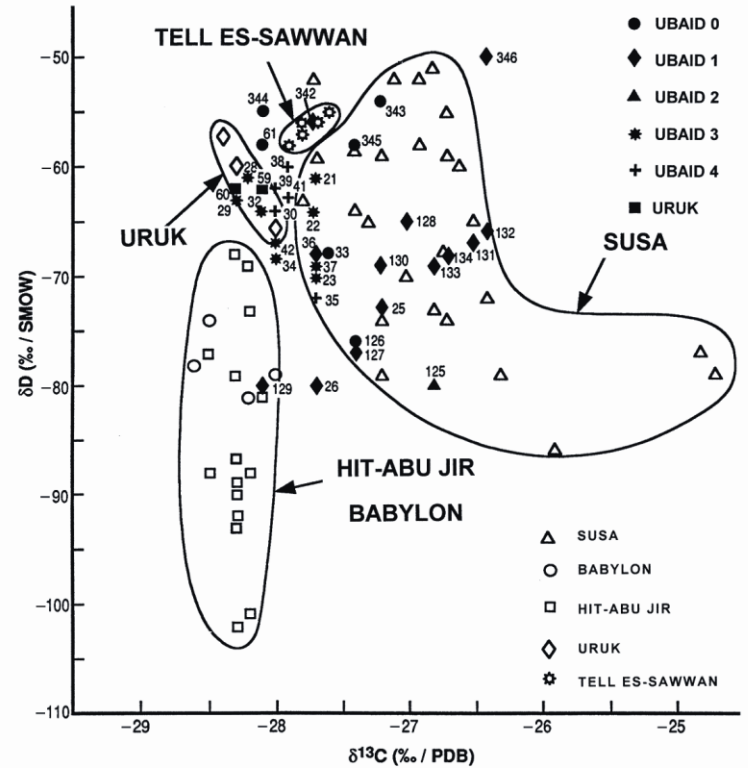


Figure 4. Plot of $\delta^{13}\text{C}$ vs δD in asphaltenes of Tell el'Oueili and some references from other archaeological sites (Susa in Iran, Babylon, Tell es-Sawwan and Uruk in Iraq) and natural asphalt deposits (Hit-Abu Jir in Iraq). Samples of Tell el'Oueili (i.e. with numbers) are presented according to their dates: Ubaid 0 (5800-5400 BC), Ubaid 1 (5400-4800 BC), Ubaid 2 (4800-4550 BC), Ubaid 3 (4550-4000 BC), Ubaid 4 (4000-3700 BC), Late Uruk (3500-3200 BC).

Bitumen

Střední Amerika

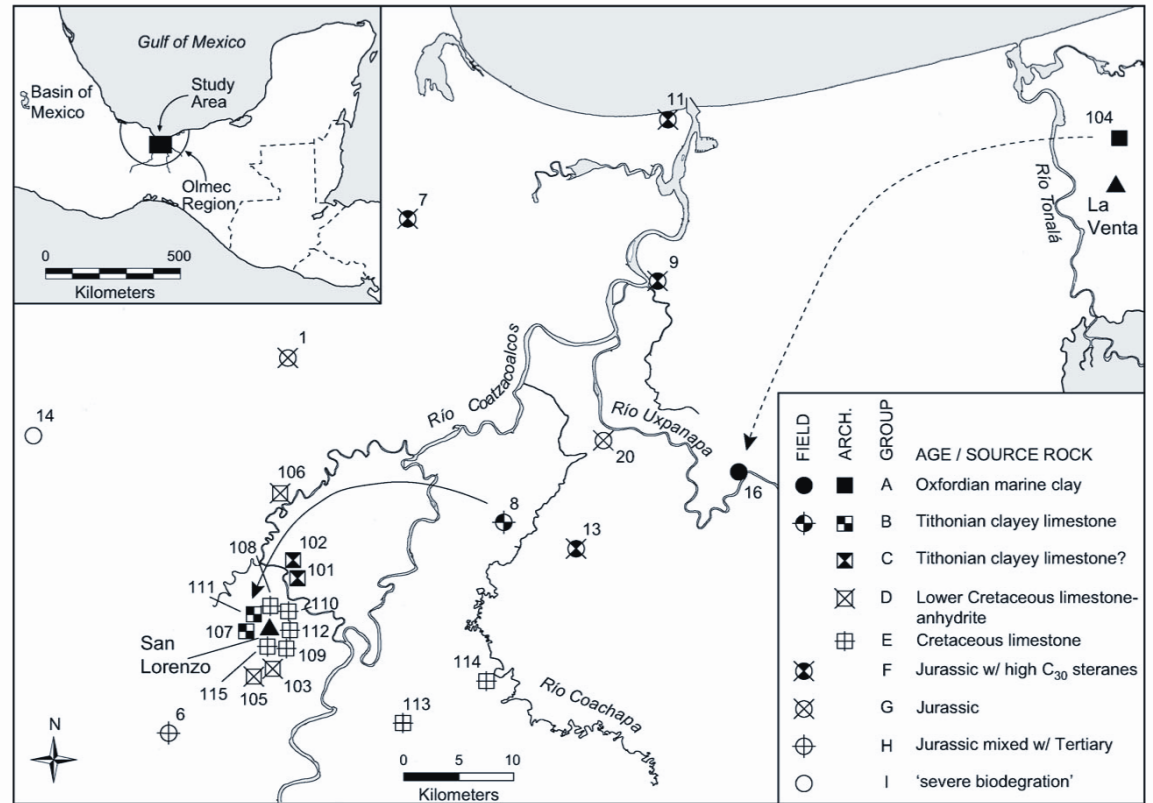


Fig. 1. Southern Gulf lowlands of Mesoamerica showing collection locations of field and archaeological bitumen samples. Field samples: (1) Jaltipan, seep; (6) La Cangrejera, seep; (7) Rancho Orel, seep; (8) Emilio Carranza, seep; (9) Paso Nuevo, seep; (11) Coatzacoalcos, beach; (13) San Cristóbal, seep; (14) Sayula, well; (16) La Concepción, seep; (20) San Carlos, seep. Archaeological samples: (101) El Remolino, El Bajío area, Profile Operation, Domestic Area-2; (102) El Remolino, El Bajío area, Profile Operation, Domestic Area-1; (103) El Azulul, Represa; (104) Isla Alor, Unit 1; (105) Loma del Zapote; (106) Paso los Ortes, Unit 1, bitumen pit feature; (107) San Lorenzo, A4, Ilmenitas; (108) San Lorenzo, B3-5; (109) San Lorenzo, C3, Monument 14; (110) San Lorenzo, D4-22; (111) San Lorenzo, B3, Monument 57; (112) San Lorenzo, D5-31; (113) El Macayal, Unidad Villaseca; (114) La Nueva Abundancia, Pozo 12; (115) San Lorenzo, C5-6. Symbols correspond to geochemical classification.

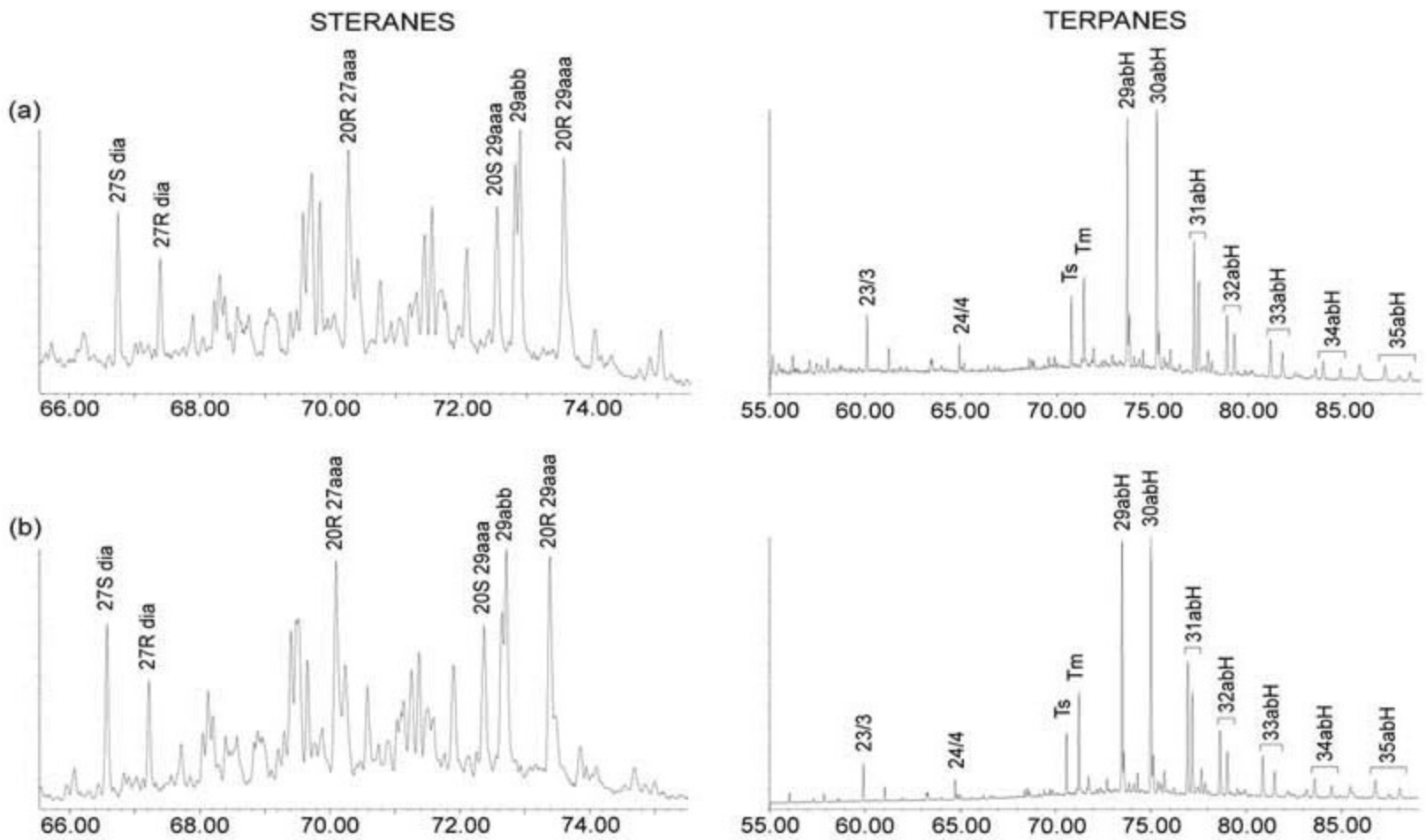


Figure 9. Steranes (m/z 217) and terpanes (m/z 191) distribution patterns in samples collected from (a) Emilio Carranza (#8, seep) and (b) San Lorenzo (#111, archaeological).

Rancho la Brea (JZ USA)

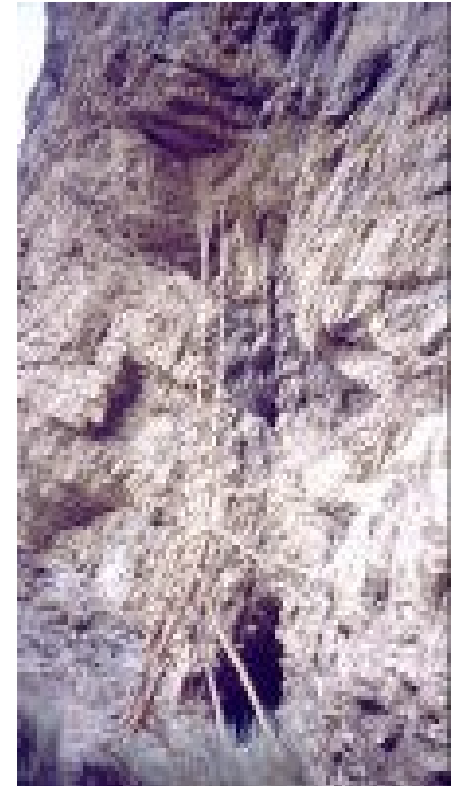


Mumio

Mumio (“horský balzám”, “horský pot”, “horská krev” nebo “horské slzy”) je známo víc než 2000 let, jeho původ je záhadný, je pravděpodobné že se pod jedním názvem skrývá více substancí.



Nachází se zejména na horských štítech Asie (Pamír, Altaj, Hindúkuš a Tsao-Shing), uvádí se i z Japonska a Alžíru. Místa nálezů bývají nepřístupné horské jeskyně a rozsedliny ve výškách cca 2000 a 3500m, se specifickými podmínkami – teplota (zimní a letní), množství slunečního záření a množství srážek.

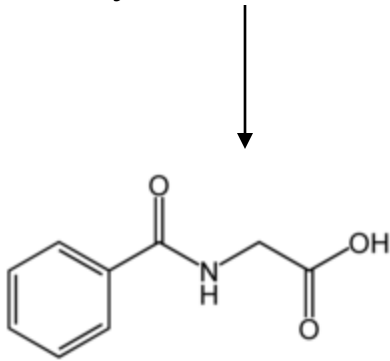


Mumio

Komplexní a heterogenní směs huminových substancí, ukazujících na rostlinný materiál.

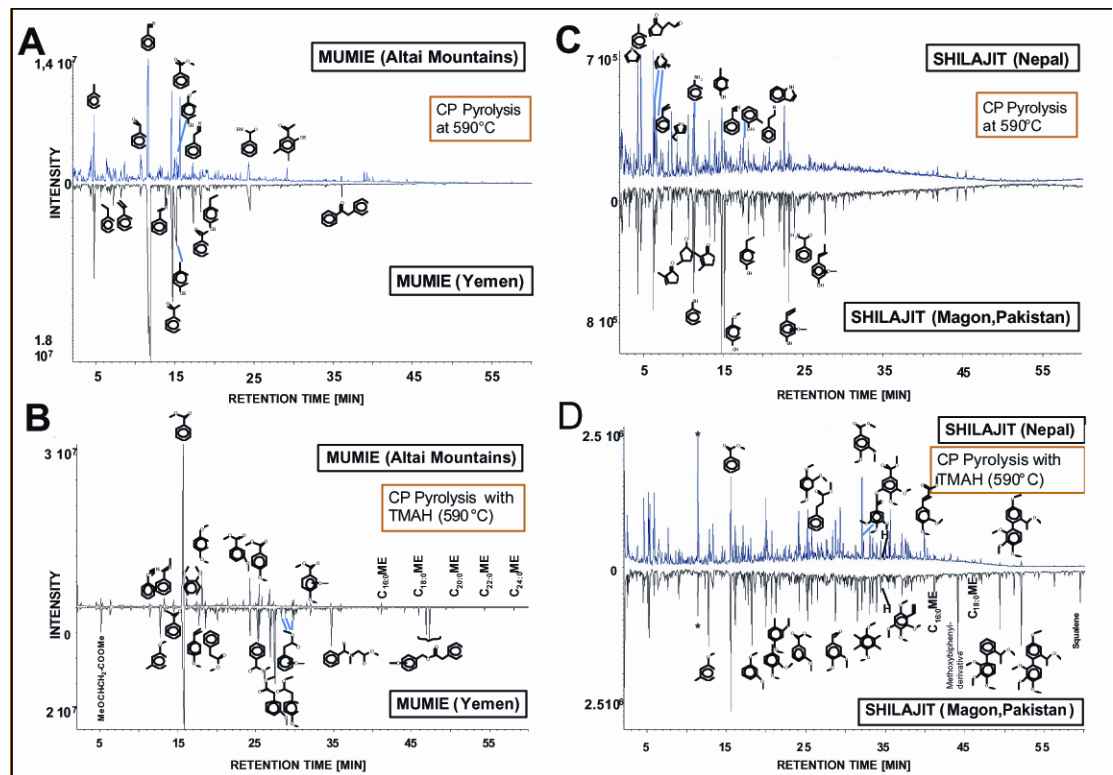
Další složky: lipidy, proteiny, sacharidy a lignin.

Hippurová kyselina a koprostanol ukazují, že při vzniku mumia hrají roli i zvířecí exkrementy.



n-alkany s dlouhým řetězcem indikují přítomnost rostlinného materiálu.

Stopy skvalenu - zdroj jsou olejnatá semena.



Další substance označované za MUMIO

Bitumen: používán v arabské medicíně, hlavně k uzavírání ran. Byl označován jako „mumíja“.

Po anexi Egypta začali „mumia“ označovat i zachované pozůstatky starých Egyptů, protože byly balzamovány (také) pomocí bitumenu.

Ve 12. století se tak, díky nedokonalému překladu arabských lékařských spisů Gerardem z Cremony, prosadil názor, že bitumen a mumifikované tkáně jsou jedno a totéž.

Až do 19. století proto byly **na prášek rozemleté mumie** používány v Evropě jako léčebný prostředek proti řadě chorob od epilepsie po nechutenství.



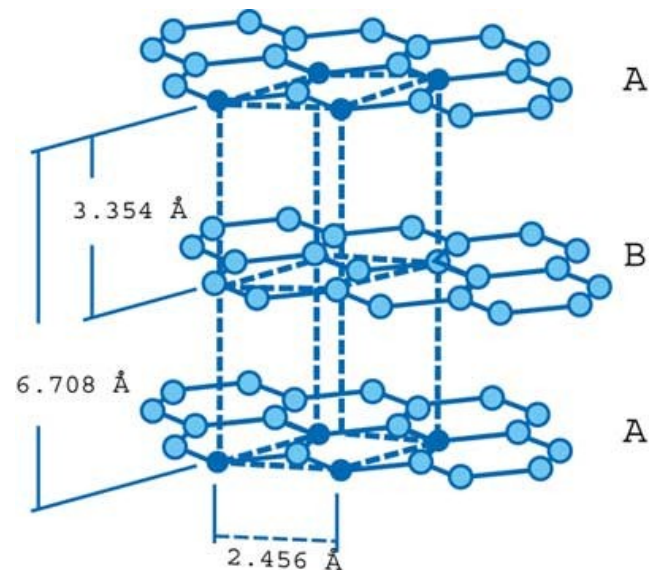
Sapropelit (švartna)

Vzniká metamorfózou sapropelu – usazeniny vzniklé anaerobním rozkladem odumřelých částí vodních rostlin a planktonu. Sediment tmavohnědé až černé barvy, podobný břidličné hornině vystupuje v nadloží černého uhlí především v kladensko-rakovnické oblasti, kde byl systematicky těžen a obráběn Kelty .



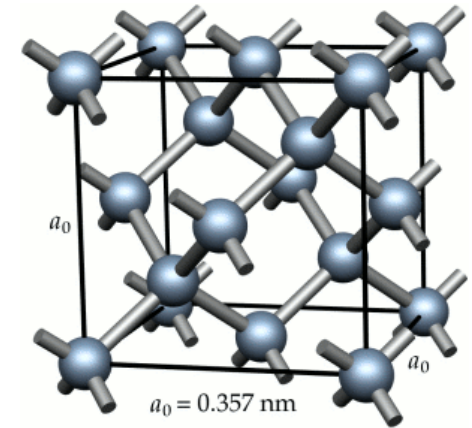
Grafit

Tvoří pigment ve vápencích a jílovitých břidlicích. Ložiska grafitu vznikají při přeměně usazených hornin ze zbytků organických látek a tvoří vrstvy nebo čočkovitá tělesa v rulách, svorech, fylitech nebo mramorech.



Diamant

Krystalická forma uhlíku, nejtvrdší známý minerál. Vzniká v zemské kůře za vysokých teplot a tlaků v ultrabazických vyvřelinách – kimberlitech. Naleziště diamantů jsou známa v Indii (oblast Golgonda), v Brazílii (stát Minas Gerais), v Jižní Africe a v Rusku.

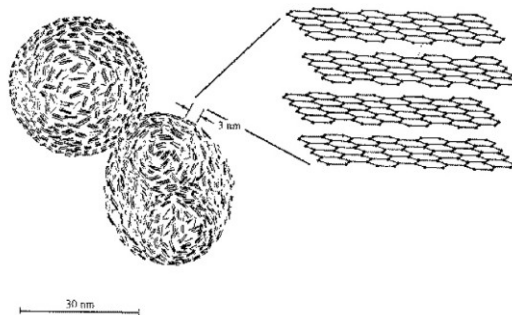


Saze

Saze jsou tmavý prachový nános nespálených palivových zbytků, obvykle složený hlavně z amorfního uhlíku.

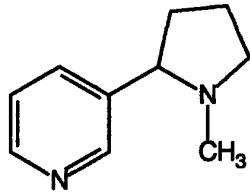


Tuš, atramentum

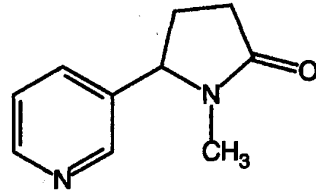


Nízkomolekulární látky

Tabák



Nicotine, NIC



Cotinine, COT



Fig. 443. A—C Bauerntabak (*Nicotiana rustica*).
A Blühende Pflanze. B Blüte. C Diefelbe im Längsschnitt.

D—J Gewöhnlicher Tabak (*N. Tabacum*).
D Blühende Pflanze. E Blüte. F Frucht. G Same. H Diefelbe im Längsschnitt. J Narbe.
(Nach Engler-Prantl.)



Adriaen van Ostade,
*An Apothecary
Smoking in an Interior*
1646, oil on panel.

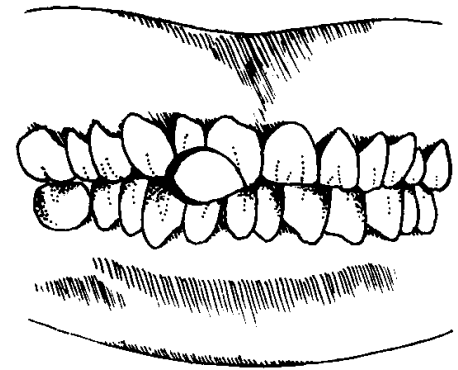
Tabák



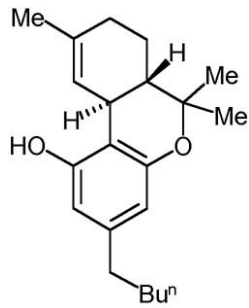
Detail chrupu muže středního věku z East Kirk of St Nicholas (Aberdeen; 17. stol.)

Table 1: Nicotine concentrations (ng/g) in the human remains from Kirchheim.

Group	n	Age	ng/g
1.	2	0- 9	32.7- 58.8
2.	2	10-19	31.8- 36.9
3.	2	20-29	33.6- 35.4
4.	4	30-39	33.0- 46.8
5.	2	40-49	37.5-149.7
6.	3	50-59	33.3- 55.2
7.	3	70-80	31.8- 39.8
8.	5	adults (20-80)	31.2- 44.4



Hašiš



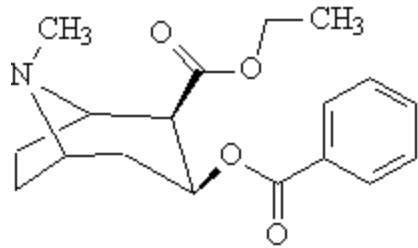
Tetrahydrocannabinol (THC)



Pazyryk (skytská mohyla)



Koka



kokain



PLATE XX.—*Erythroxylon coca* (Coca). (From Jackson: *Experimental Pharmacology and Materia Medica*.)

Koka



Figure 1. A coca-leaf "quid" distends the left cheek of the naturally mummified remains of a 36-year-old male from the Maitas Chiribaya culture.

TABLE 1
Radiocarbon Dating and Cocaine Tests from the Pisagua-7 Site

Mummy Number	Age(Yr)	Sex*	Cocaine Test			14C Lab No.	Radiocarbon Dates	
			Matrix**	ng/10mg***	Pos/Neg****		13C-corrected Conventional Radiocarbon Age (+/- 1 sigma B.P.)	Calibrated Date***** 2 sigma
726-A	5-7	I	H	0.3	Neg	GX16097 (Muscle)	2955 +/- 115	1443-858 I = 1154 BC(RAD)
723	25-30	M	H	0.7	Neg	GX16098 (Skin)	2695 +/- 85	1012-764 I = 833 BC(RAD)
725-A, C2	40-45	F	H	13.3	Pos	Beta 169826 (Hair)	2850 +/- 50	1140-900 I = 1000 BC(AMS)
741	3-4	F	N	5.6	Pos	Beta 170070 (Hair)	2730 +/- 40	940-810 I = 850 BC(AMS)

*Sex: I = Indeterminate, M = male, F = female.

**Matrix: H = hair, N = nail.

***ng/10mg = nanograms/10 milligrams of sample. Values of 3.0 or greater = positive.

****Neg = negative, pos = positive.

*****I = value at line of intercept. (RAD) = radiometric method; (AMS) = accelerator mass spectrometry method. GX = Geochron Laboratories, Cambridge, Massachusetts. Beta = Beta Analytic Laboratory, Miami, Florida.

Stanovení v lidských pozůstatcích

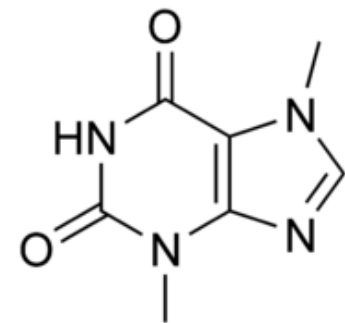
CONCENTRATIONS (ng/g) OF ALKALOIDS AND METABOLITES

—	Cocaine	Nicotine	Hashish
<i>Peru (natural mummies)</i>			
Hair	220–13 900 (12)	28–1400 (12)	50–1700 (17)
Soft tissue	43–1371 (10)	57–1997 (6)	49–2795 (8)
Brain	42–185 (4)	84–587 (3)	15–138 (4)
Teeth	10–113 (5)	17–104 (7)	15–39 (4)
Bone	26–326 (16)	39–577 (26)	14–276 (20)
<i>Egypt (artificial mummies)</i>			
Hair	24–200 (4)	140–900 (4)	800–4100 (4)
Soft tissue	70–442 (8)	125–1045 (10)	59–2875 (10)
Bone	25–110 (6)	45–1050 (11)	36–2800 (10)
<i>Bell culture</i>			
Bone	0 (10)	56–142 (8)	0 (10)
<i>Sudan</i>			
Bone	0 (2)	87–93 (2)	0 (2)

No of samples in parentheses.

Kakao

Kakaovník pravý (*Theobroma cacao*)



theobromin

Kakao

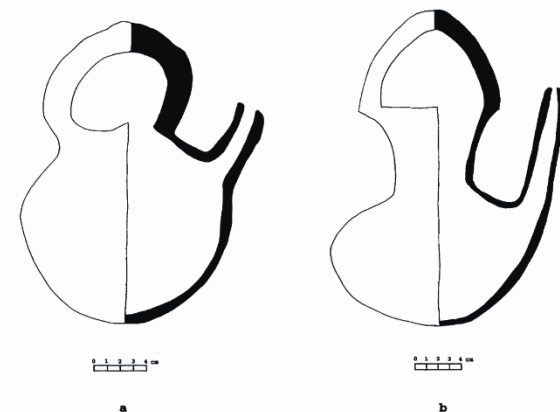
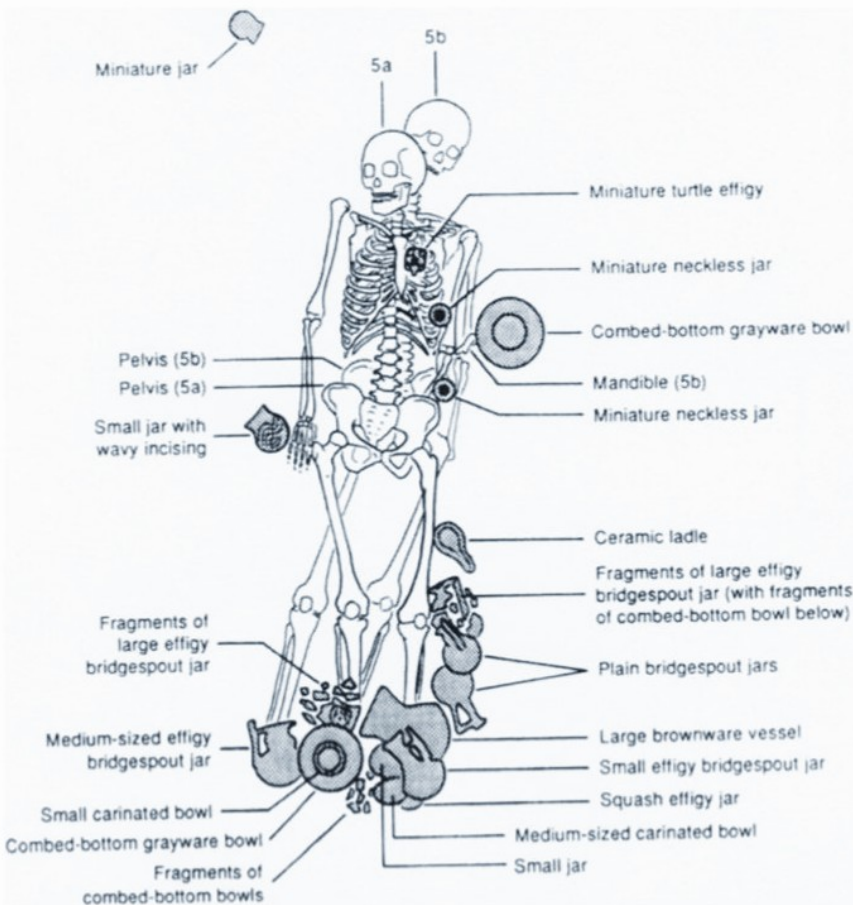


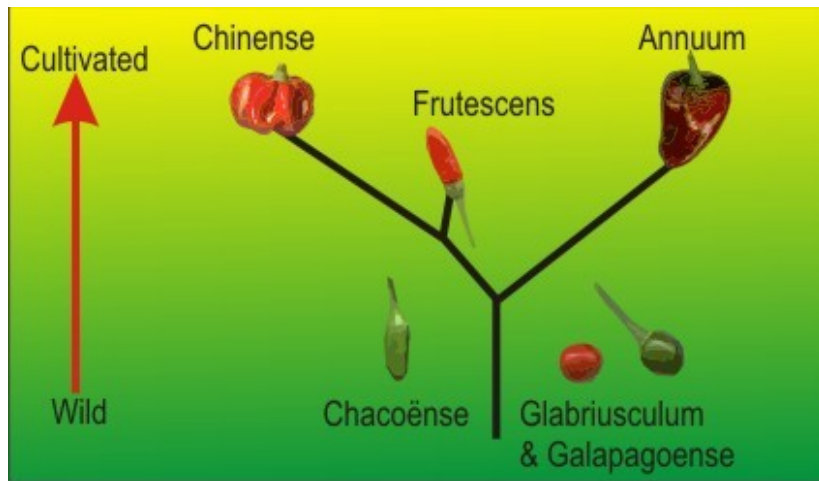
Figure 10. Spouted vessels from Colha, Belize containing substantial cacao residues; a: Unnamed Black and Fluted (Chunhinta Ceramic Group) type jar found in burial Strat 67 of Op. 2012 (after Valdez 1987:107-108; b: Unnamed Black, Fluted, and Red Stuccoed (Chunhinta Ceramic Group) type jar found in burial Strat 61 in Op. 2012. (Illustrations by Jenifer Bryan and courtesy of Thomas R. Hester and Fred Valdez, Jr.)



Figure 5. Late Preclassic spouted vessels from Oaxaca; a: spouted jars from Burials 5a and 5b, possibly a husband and wife from an elite family, at Abasolo, Oaxaca (after Marcus and Flannery 1996:171). Illustration courtesy of Joyce Marcus.

Paprika

Paprika (Capsicum)



Paprika

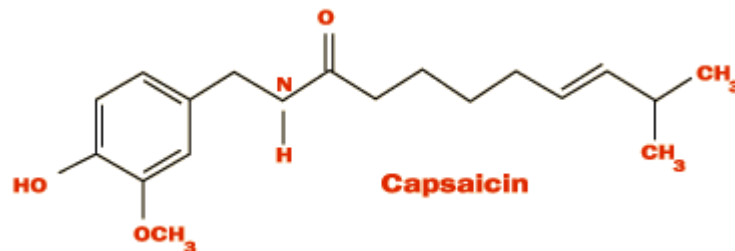


Table 1. Quantitative analyses of capsaicinoids in fresh fruits and archaeological samples

Sample	Sample weight (mg)	Capsaicin (mg) ^a (percentage content)	Dihydrocapsaicin (mg) ^a (percentage content)
<i>Capsicum annuum</i> , fresh fruits	499	0.429 ± 0.004 (0.086%)	0.154 ± 0.003 (0.031%)
<i>Capsicum frutescens</i> , fossil fruits	966	0.036 ± 0.005 (0.0037%)	0.049 ± 0.005 (0.0051%)
10482 (R.233) ^b	1072	nd ^c	nd
10493 (R.236) ^b	984	nd	nd
10523 (R.239) ^b	1146	nd	nd

^a Mean ± standard deviation ($n = 3$).

^b Archaeological sample from cemetery number 2 at Yaral (Peru).

^c nd = none detected.

Betel

Listy pepřovníku betelového

Ořech arekové palmy (nezralé)



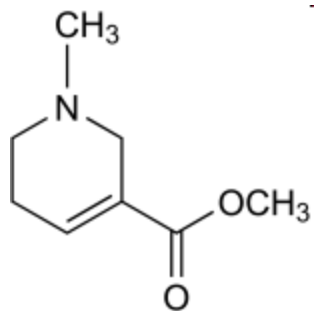
Areca catechu L.



PIPER BETLE.—LINN.—De Blanco.

1. betle

L. C. DeSaguer. Sculp.



arekolin

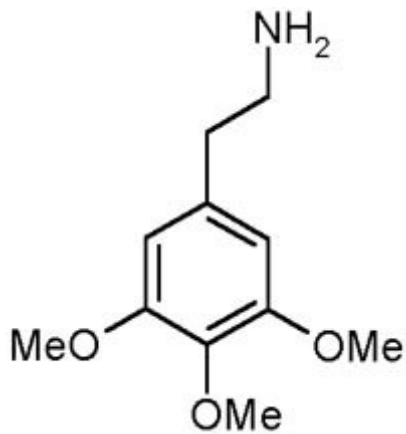
arekaidin
guvacin
guvakolin

Vlastní betelové sousto se připravuje tak, že se na listy pepřovníku betelového obvykle dá vápno a dále se položí část semene arekové palmy, případně kousek kořene gambirovníku. Takto připravené komponenty se těsně zavinou do pepřovníkového listu, vloží do úst a sousto se intenzivně žvýká.



Peyotl

přírodní droga, rituálně užívaná indiánskými kmeny (Huicholové, Tarahumara) v Mexiku



meskalin

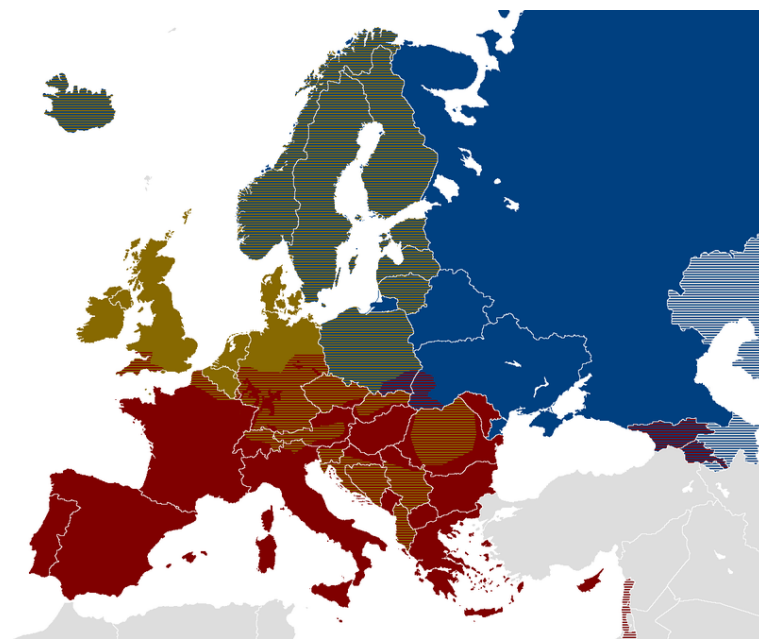
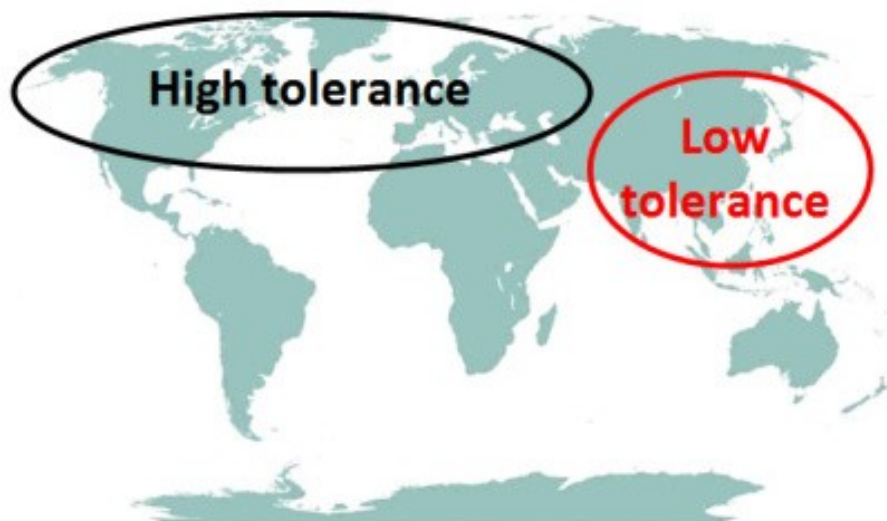
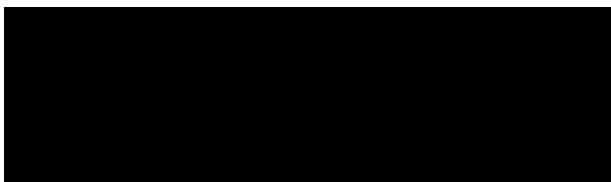


kaktus *Lophophora williamsii*

Alkoholické nápoje

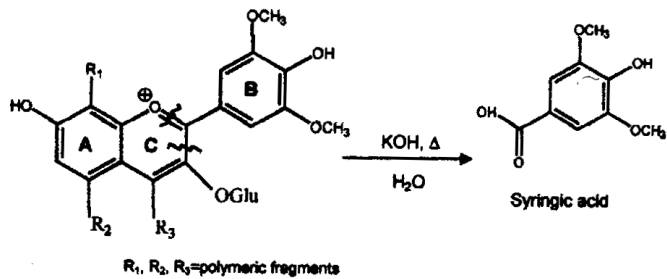
Alkoholické nápoje jsou nápoje, obsahující přes 0,75 objemových procent ethanolu.

Jejich požití způsobuje opilost: v menších dávkách (v závislosti na metabolismu jedince) uvolnění a euforické stavy, nebo pocity napětí, ve větších dávkách útlum, nevolnost až otravu.



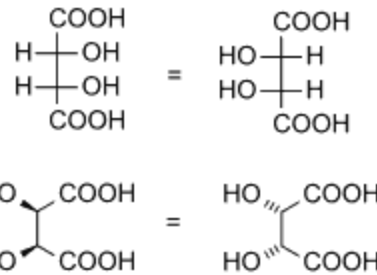
Pásky dle typického druhu alkoholu, které se na daném území konzumuje (pás vína, pás piva, pás vodky)

Víno



Malvidin-3-glucoside in the polymerized pigment

Figure 3. Production of syringic acid. Syringic acid is released from the flavylum structure of malvidin-3-glucoside in the polymerized pigment by alkaline fusion through the formation of a hydrated hemichemical form in which the pyran (C ring) is broken in two steps.



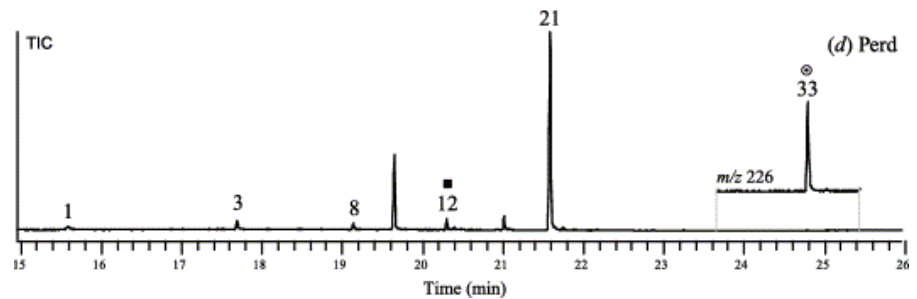
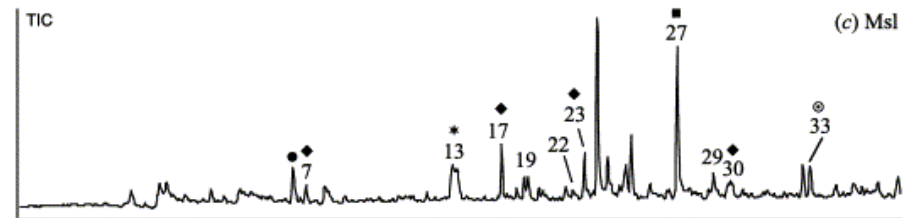
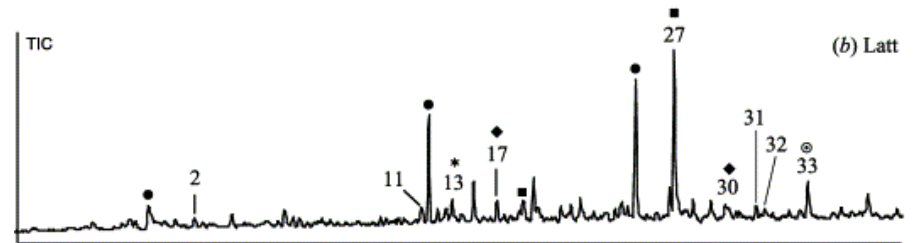
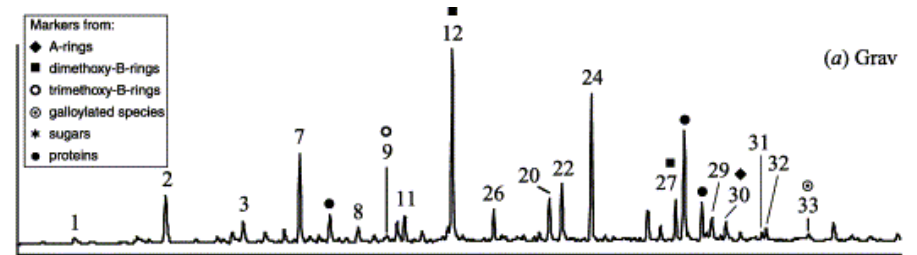
Víno lze ve výjimečných případech (např. v amforách z Tutanchamonovy hrobky v Egyptě) identifikovat na základě přítomnosti charakteristických biomarkerů. Pro víno je typická kyselina tartarová). Malvidin-3-glucosid je flavonoidní pigment zodpovědný za červenou barvu vína, nelze ho ale stanovit přímo – zalkalizováním vzorku se z něj uvolňuje kyselina syringová, ta se detekuje a její přítomnost pak charakterizuje červené víno. Přítomnost pouze kyseliny tartarové ukazuje spíše na bílé víno.

Víno

Keramika
Paleobotanika

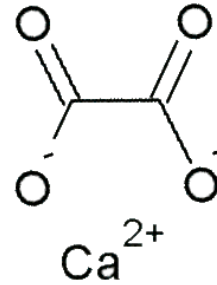
polyfenoly
vinná kyselina

syringová kyselina
(specifická pro červené víno)

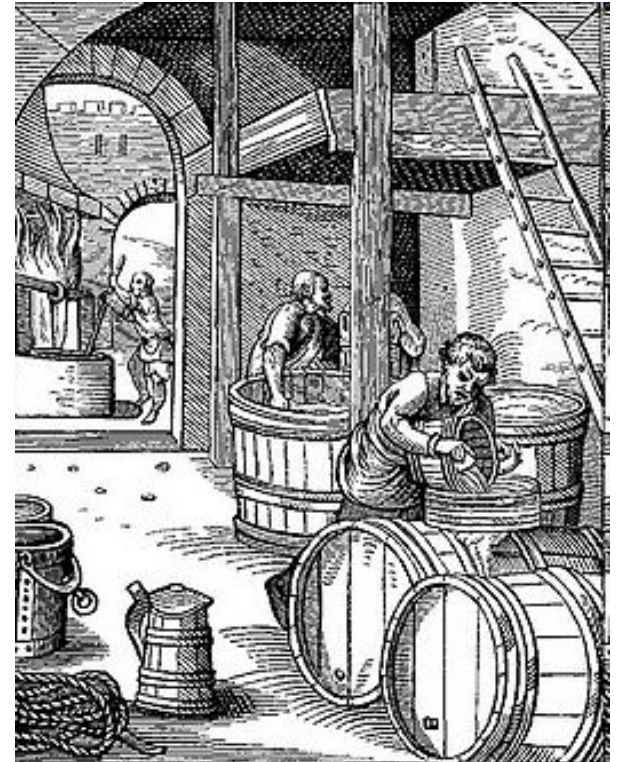


Pivo

Nelze specificky prokázat.



šřavelan vápenatý
(„pivní kámen“)

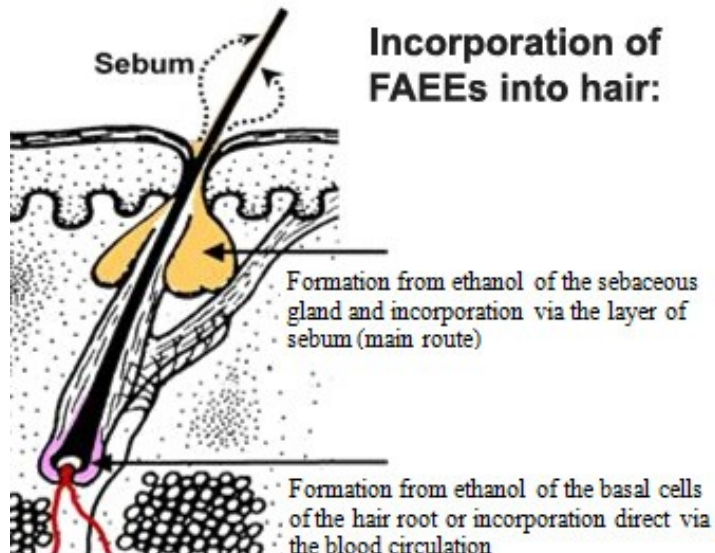


Reesterifikace lipidů

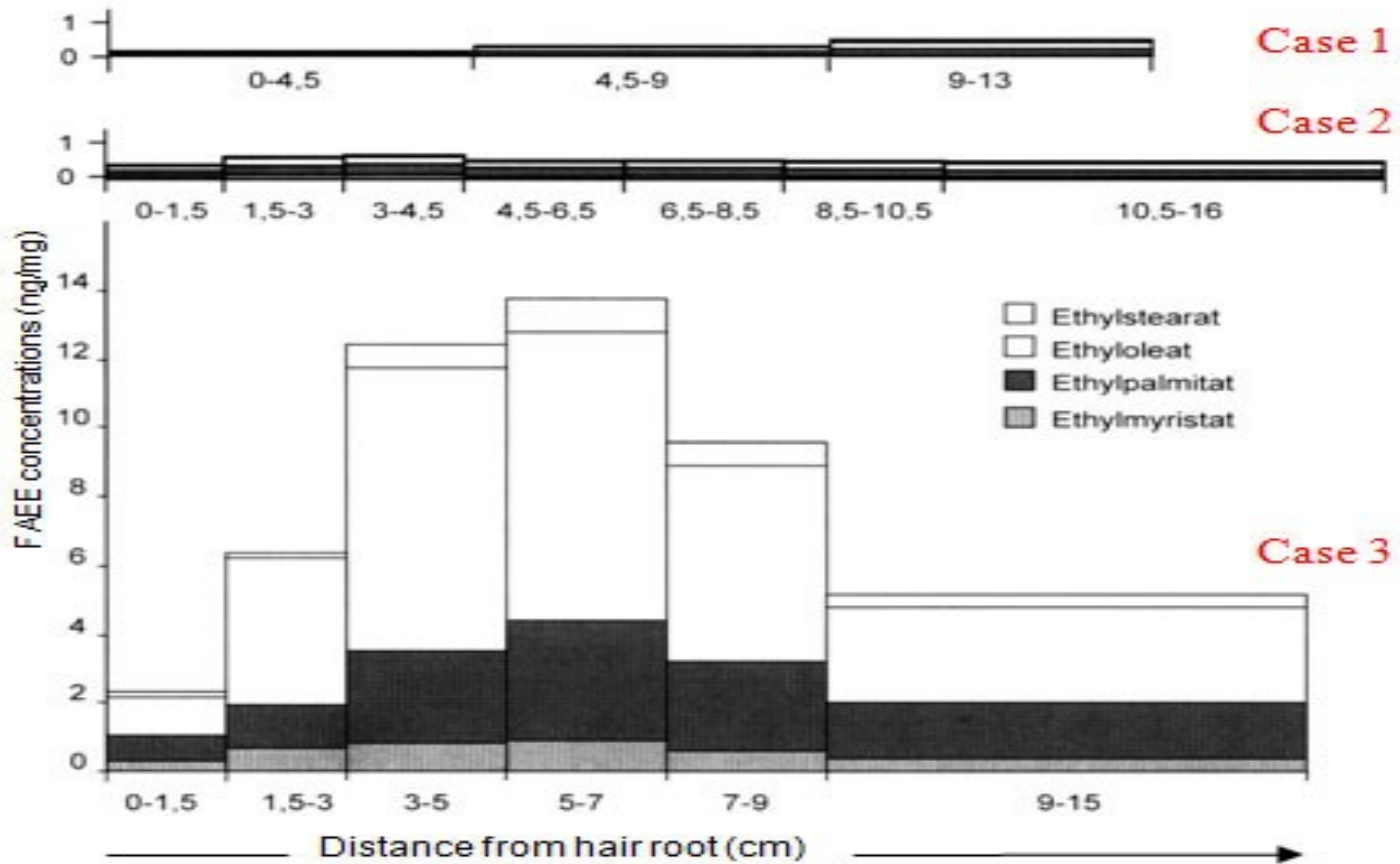
Ethylestery MK v tuku

(vlasy, tuková tkáň) – forenzní materiál:

významné zastoupení v tkáních
chronických alkoholiků



Ethylestery mastných kyselin byly nalezeny ve vlasech mumií (mužů i žen) kultury Chiribaya (JZ Peru, poušť Atacama, 1000-1250 n.l.). Zdrojem ethanolu byl fermentovaný kukuřičný nápoj „chicha“.

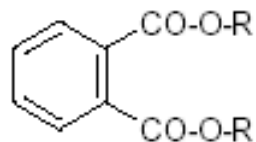


Case 1 abstinent

Case 2 příležitostný (společenský) piják

Case 3 alkoholik v léčbě (60 gramů ethanolu/ den po dobu 6 měsíců).

Kontaminace vzorků



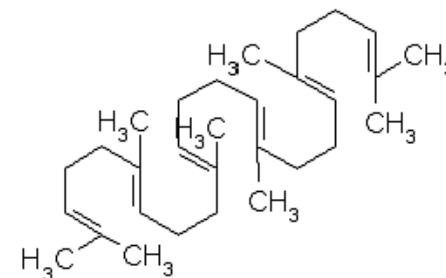
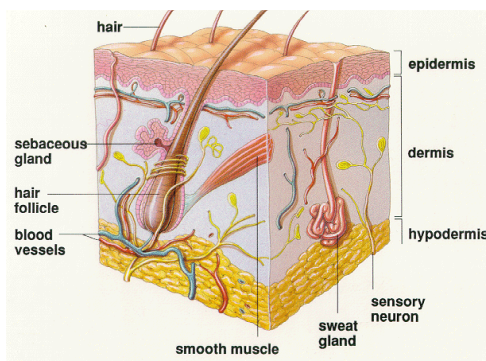
R=alkyle ramifié en C₈₋₁₀

Plastikové nádoby a sáčky

ftaláty (měkčidla plastů)

Kontakt s lidskou pokožkou

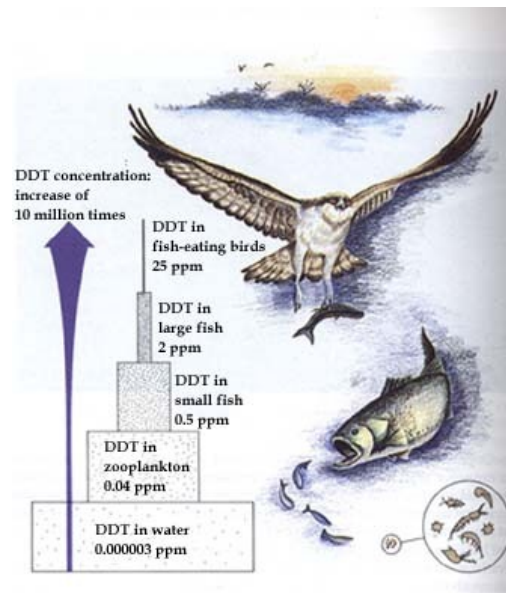
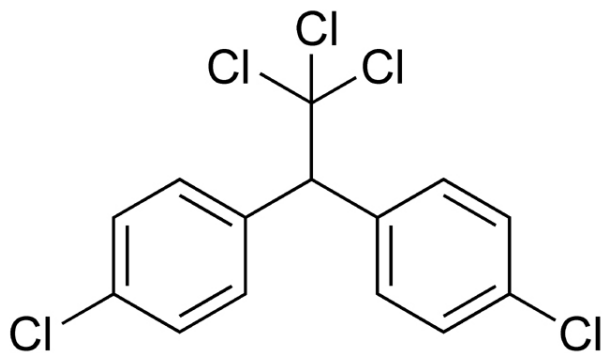
skvalen (součást tuku lidské kůže)



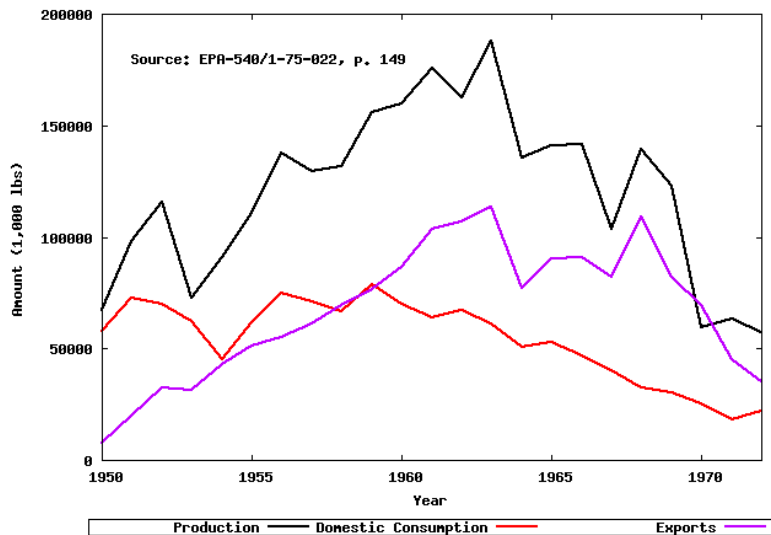
Chlorované pesticidy



DDT



Domestic Production, Consumption, and Exports of DDT in the United States, 1950-1972



HCH (lindan)

Technický lindan je tvořen zejména gama-isomerem hexachlorocyclohexanu, HCH (99%). Pět ostatních isomerů se v technickém lindanu opět vyskytuje, nemsají však insekticidní účinek.

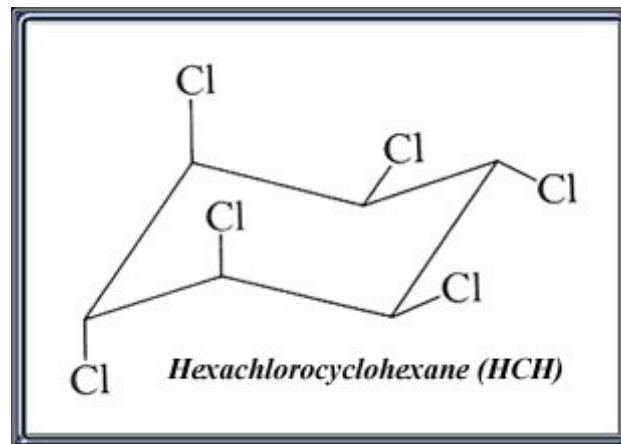




Figure 1. DDT crystals on the surface of a wooden sculpture.



Figure 3 The powder seen on these objects from the 'Arkæologikælderren' is DDT in approximately 20% concentration.

Chlorované látky a muzejní exponáty

Table 1 Survey of adsorption losses of insecticides from five different materials. All losses are given in % in proportion to reference.

	Pinewood	Woven wool	Paper	Veg. tanned leather	Duck down
p-dichlorobenzene	34	43	31	0	43
Naphthalene	11	36	6	0	13
Lindane	6	0	0	3	0
Aldrin	7	2	1	1	0
Dieldrin	12	11	10	0	5
DDT	19	13	13	7	0
Methoxychlor	0	0	0	1	0

Table 2 Insecticides found in the 118 samples taken: number analyzed, results of analysis, and detection limits for each insecticide. Control analyses have not been performed on the amounts of lindane, aldrin and dieldrin found.

Name	Number of analyzed samples	Analysis results (mg/g sample material)	Detection limit (mg/g sample material)
p-dichlorobenzene	96	No positive, many traces	0.062
Naphthalene	96	26 pos = 27% $\bar{x}_{tot} = 0.02$ $\bar{x}_{pos} = 0.07$	0.005
Lindane	102	2 pos = 2% $\bar{x}_{pos} = 0.08$	0.012
Aldrin	102	1 pos = 1% $\bar{x}_{pos} = 0.90$	0.017
Dieldrin	102	1 pos = 1% $\bar{x}_{pos} = 0.60$	0.017
DDT	102	50 pos = 49% $\bar{x}_{tot} = 17.99$ $\bar{x}_{pos} = 37.87$ $\bar{x}_{pos > 5} = 206.40$ (9 samples) $\bar{x}_{pos \leq 5} = 0.87$ (41 samples)	0.039
Methoxychlor	102	28 pos = 27% $\bar{x}_{tot} = 0.86$ $\bar{x}_{pos} = 3.14$	0.021

Table 3 The vapour pressure of the seven analyzed insecticides. Data from The Pesticide Manual, British Crop Protection Council (1979)

Name	Vapour pressure
p-dichlorobenzene	92.0 Pa at 20°C
Naphthalene	6.5 Pa „ „
Lindane	1.3 mPa „ „
Aldrin	700 μPa „ „
Dieldrin	400 μPa „ „
DDT	25 μPa „ „
Methoxychlor	very low

Chlorovaná látky v muzejních exponátech

Table 2. Geometric means (95% confidence intervals) for DDT compounds and other selected organochlorine residues in skin of free-tailed bats from Carlsbad Cavern (concentration values are expressed in $\mu\text{g/g}$ lipid weight; means for each chemical with shared letters are not significantly different)

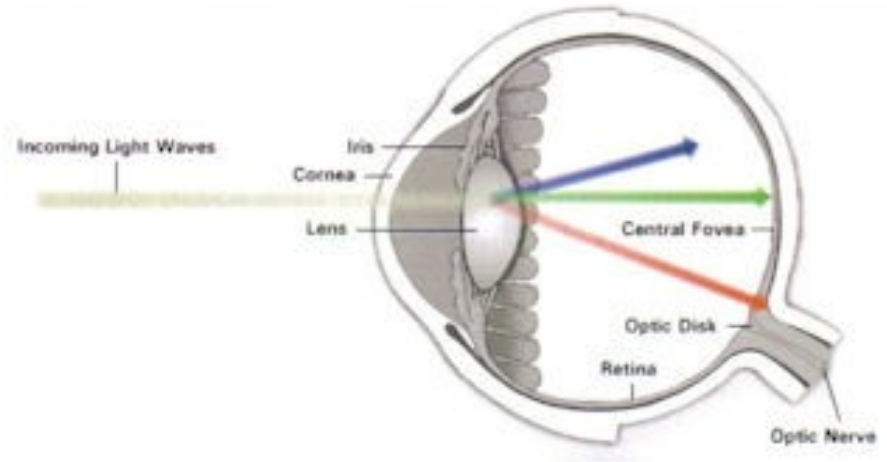
Residue	Year				
	1930 (n = 3)	1956 (n = 4)	1965 (n = 8)	1973 ^a (n = 5)	1988 (n = 6)
DDE	14.7A (7.28–29.7)	27.2AB (17.2–42.9)	86.3BC (69.6–107)	128C (48.7–335)	30.8AB (9.31–102)
DDT	21.5A (10.7–43.4)	23.1A (14.5–36.9)	32.5A (28.3–37.5)	2.33B (1.32–4.10)	1.30B (0.504–3.33)
DDE/DDT	0.682A (0.535–0.869)	1.17A (1.09–1.27)	2.65A (2.19–3.21)	54.9B (35.3–85.4)	23.8B (5.72–99.0)
DDTs toxic load ^b	22.5AB (11.1–45.5)	25.0AB (15.6–39.8)	38.4A (33.5–44.1)	10.9BC (4.54–26.3)	3.96C (1.51–10.4)
o,p'-DDT	11.3A (7.72–16.6)	6.40A (5.35–7.65)	7.79A (6.81–8.92)	—	0.489B (0.272–0.881)
PCBs	79.7A (44.1–144)	76.7A (54.7–108)	64.3A (56.7–72.9)	—	23.1B (11.0–48.2)
Dieldrin	0.897A (0.523–1.54)	1.36A (0.898–2.06)	1.91AB (1.78–2.05)	—	4.62B (1.44–14.9)
Lindane	0.786A (0.623–0.993)	1.47A (1.27–1.69)	1.03A (0.878–1.21)	—	0.267B (0.126–0.563)

^a Data were estimates based on analyses of whole bats minus gastrointestinal tract; see text for further explanation.

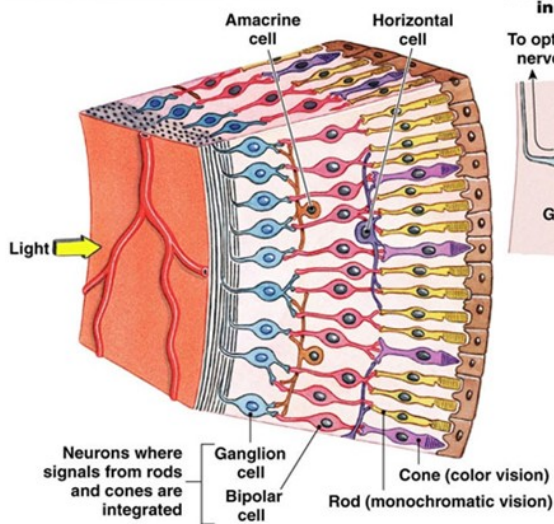
^b Equivalent to $\mu\text{g/g}$ DDT plus ($[\mu\text{g/g DDE}]/15$); see text for further explanation.

Barviva

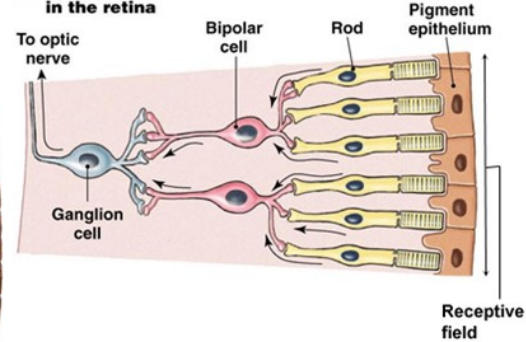
Fyziologie zraku



(d) Organization of the retina

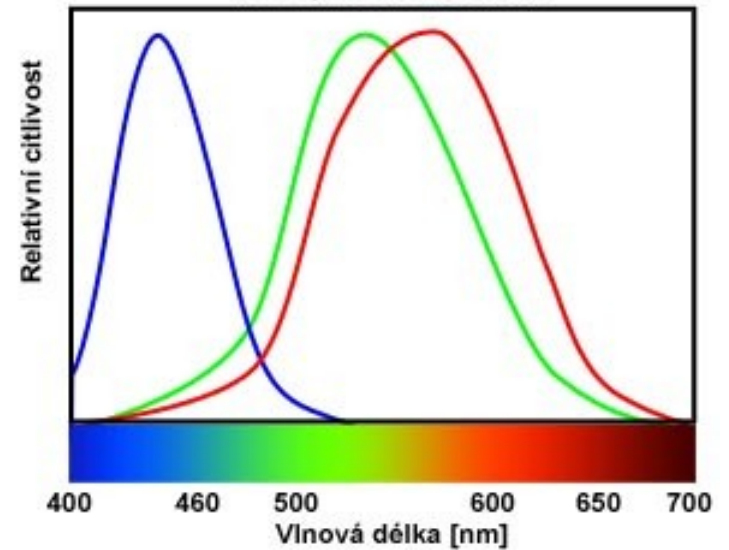


(e) Convergence in the retina



Citlivost lidského oka na barvy

3 druhy buněk oka hrubě odpovídají modré, zelené a červené



Absorpce záření

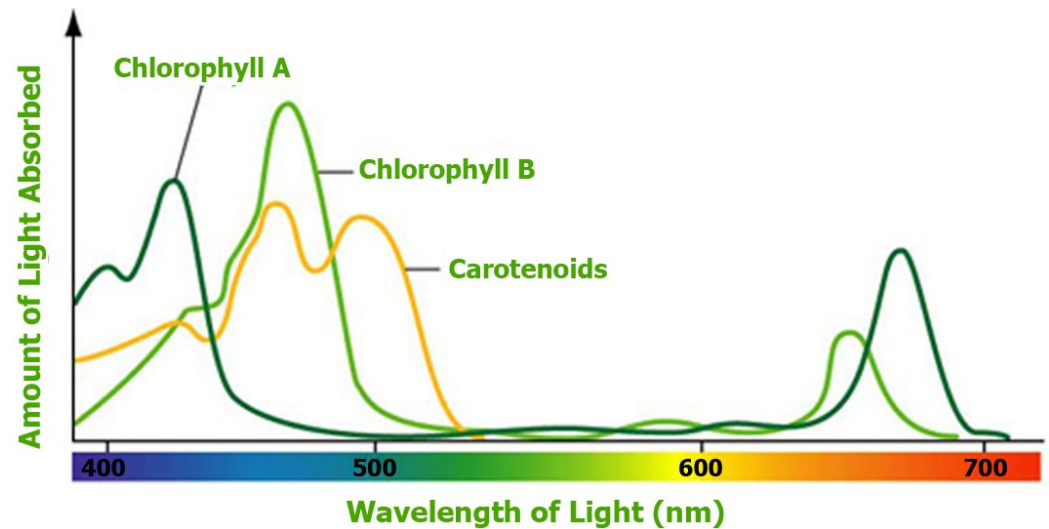
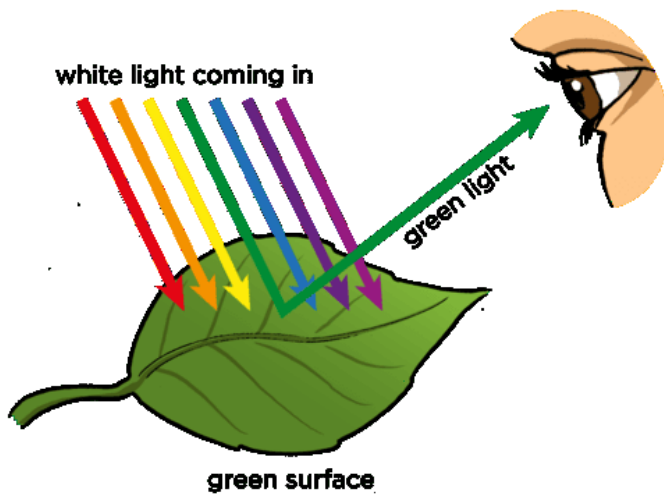
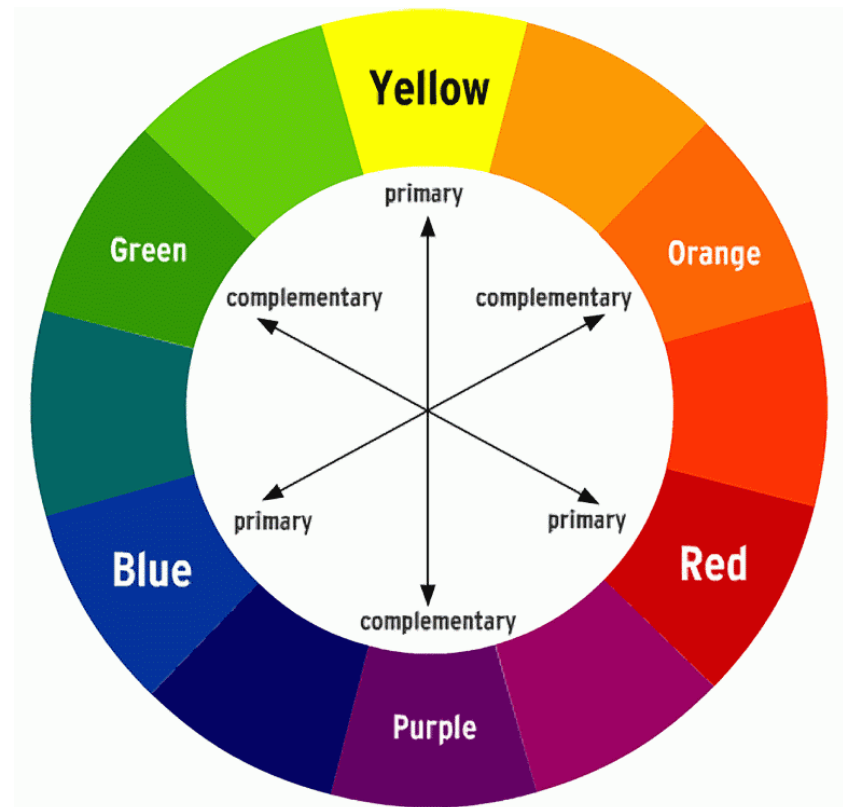
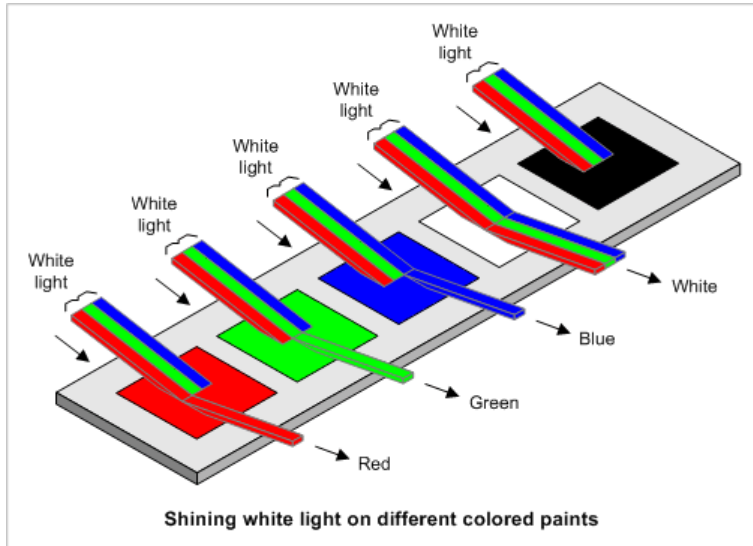


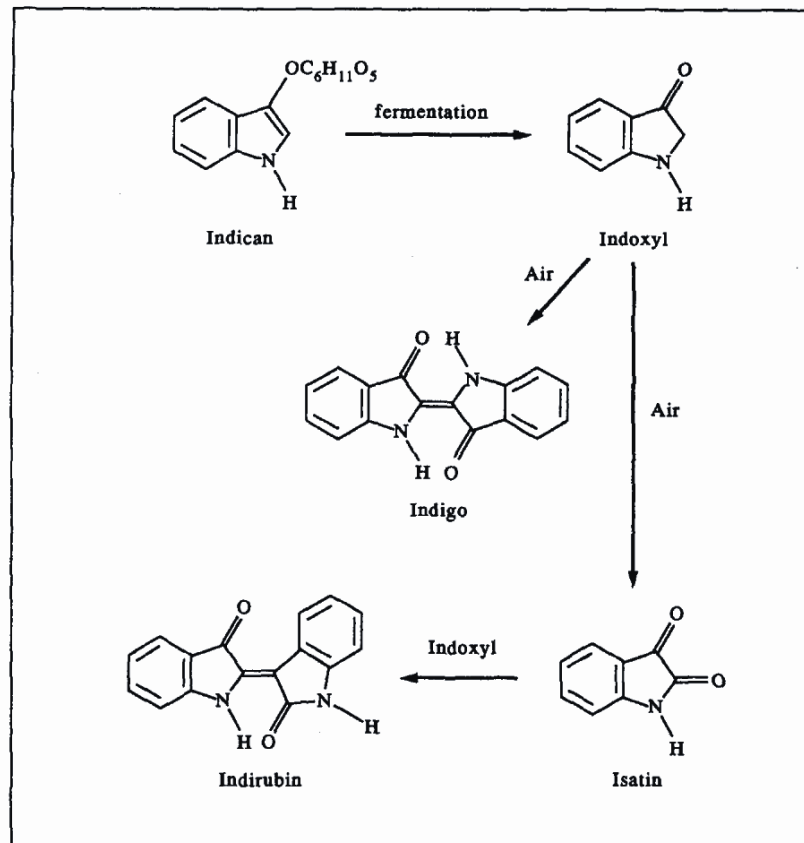
TABLE 92 Ancient Dyes

Color	Dye (common name)	Source
<i>Vegetable Source</i>		
Black	Carob	<i>Caesalpinia brevifolia</i> trees
	Sticky alder	<i>Aldus glutinosa</i> trees
	Walnut	Shells of <i>Juglans nigra</i> nuts
Brown	Chestnut	Fruit of <i>Castanea sativa</i> trees
Blue	Indigo	Indigo (<i>Indigofera</i>) plants
		Woad (<i>Isatis tinctoria</i>) plants
Green	Myrtle	<i>Myrtus communis</i> shrub
	Yarrow	<i>Achillea milleforium</i>
Orange	Henna	Various species of <i>Lawsonia</i> shrubs
Purple	Archil (or argol)	<i>Lecanora tartara</i> and other lichens
Red	Alkanet	Roots of <i>Anchusa tinctoria</i> plants
	Annato	Fruits of <i>Bixa orellana</i> shrubs
	Brazil wood	Various trees of the <i>Caesalpine</i> species
	Madder	Roots of <i>Rubiacea</i> plants
	Sandalwood	Wood of <i>Pterocarpus santalinium</i> trees
	Violet	Ficus
Yellow	Berberry root	<i>Berberis vulgaris</i> bush
	Fustic	<i>Chlorophora tinctoria</i> trees
	Quercitron	<i>Quercus discolor</i> and <i>Quercus tinctoria</i>
	Young fustic	<i>Rhus cotinus</i> trees
	Gambier	Resin exuded by <i>Uncaria gambir</i> shrubs
	Safflower	Bastard saffron (<i>Carthamus tinctoria</i>) plants
	Saffron	Saffron (<i>Crocus sativus</i>) plants
	Turmeric	<i>Curcuma</i> plants
	Weld	<i>Reseda luteola</i> plants
<i>Animal Source</i>		
Light blue	Tekhelet	Several varieties of <i>Janthina</i> molluscs
Purple	Tyrian purple	<i>Murex</i> molluscs
Red	Cochineal	<i>Coccus cacti</i> insects
	Kermes	Female <i>Kermococcus vermilia</i> insects
	Lac dye	Lac resin, secreted by <i>Kerria lacca</i> insects

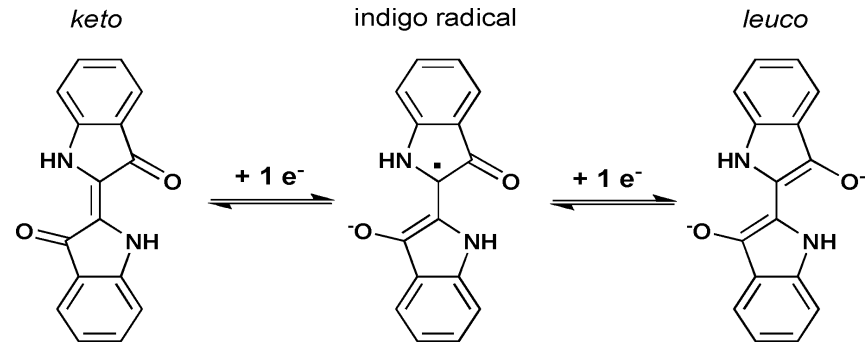
Indigo



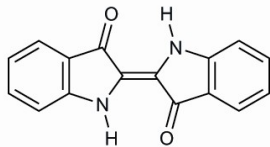
Isatis tinctoria (woad).



Scheme 1 The production of natural indigo and the by-product indirubin.



indigo



5, 5'-dibromoindigo

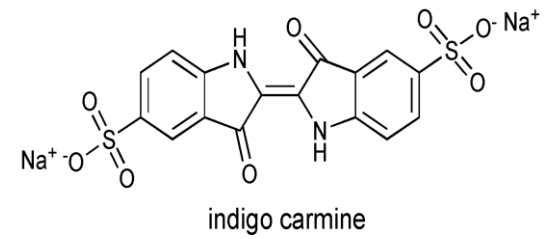
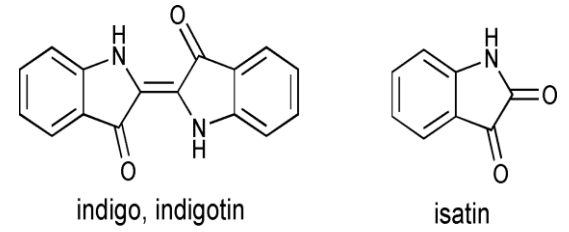
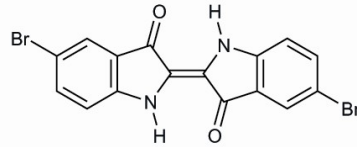


Table 1. Characteristics of selected indigoid compounds and their precursors

Class	Compound	Structure	λ_{max} (nm) (DMSO)	
Indigoid coloring agents	Indigo, indigotin (blue)		617	
	Indirubin (red)		540	
	Isoindirubin (red)		552	
	Isoindigo (brown)			365
				490
	6,6'-Dibromoindigo (purple)		585 597	
Indigoid precursors	Indican		218, 280	
	Isatan		218, 280	

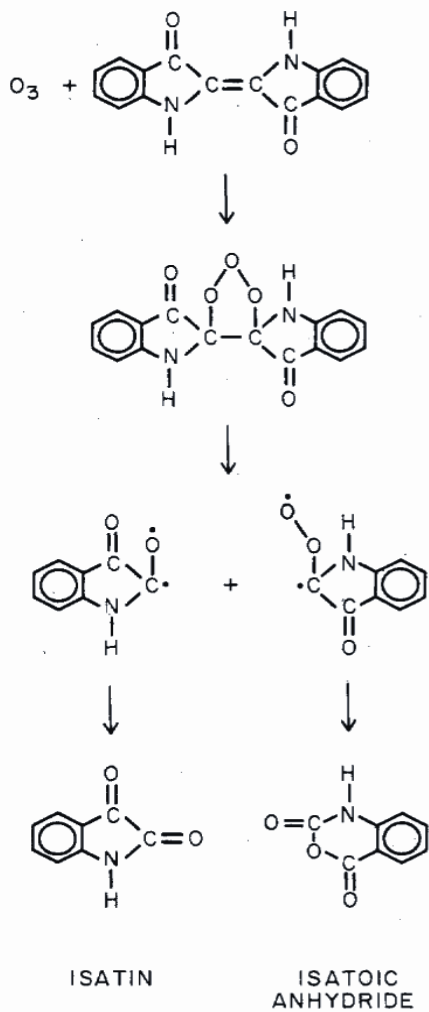


Figure 3. Mechanism of the ozone-indigo reaction.

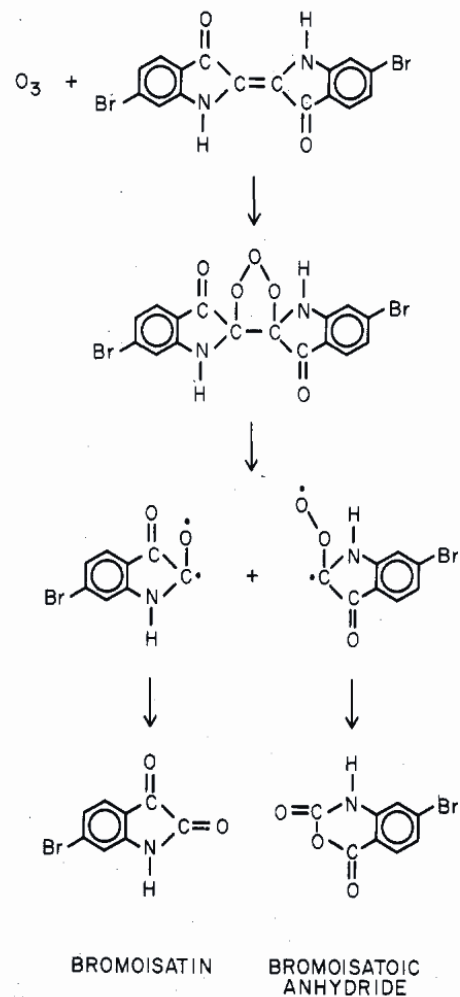
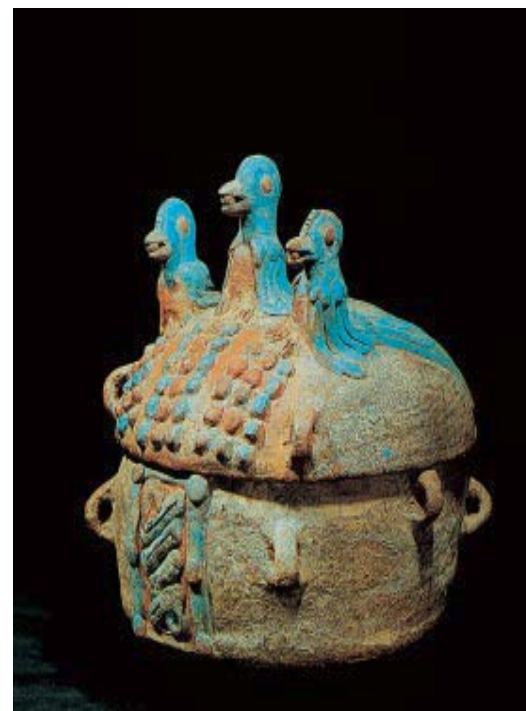
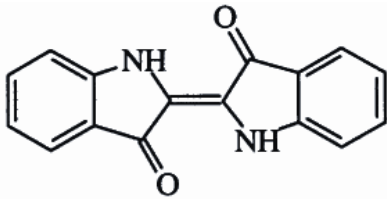


Figure 4. Tentative mechanism for the ozonide-dibromoindigo reaction.

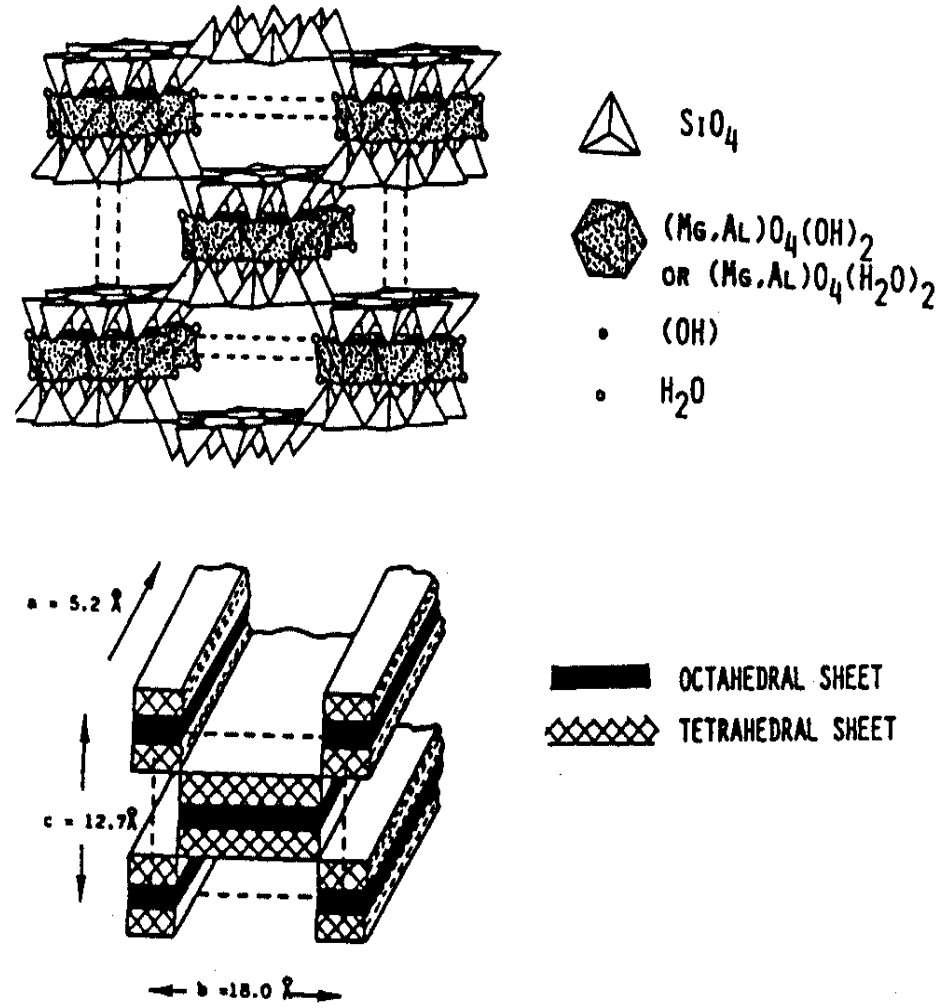
Mayská modř



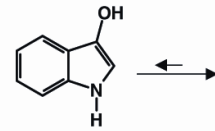
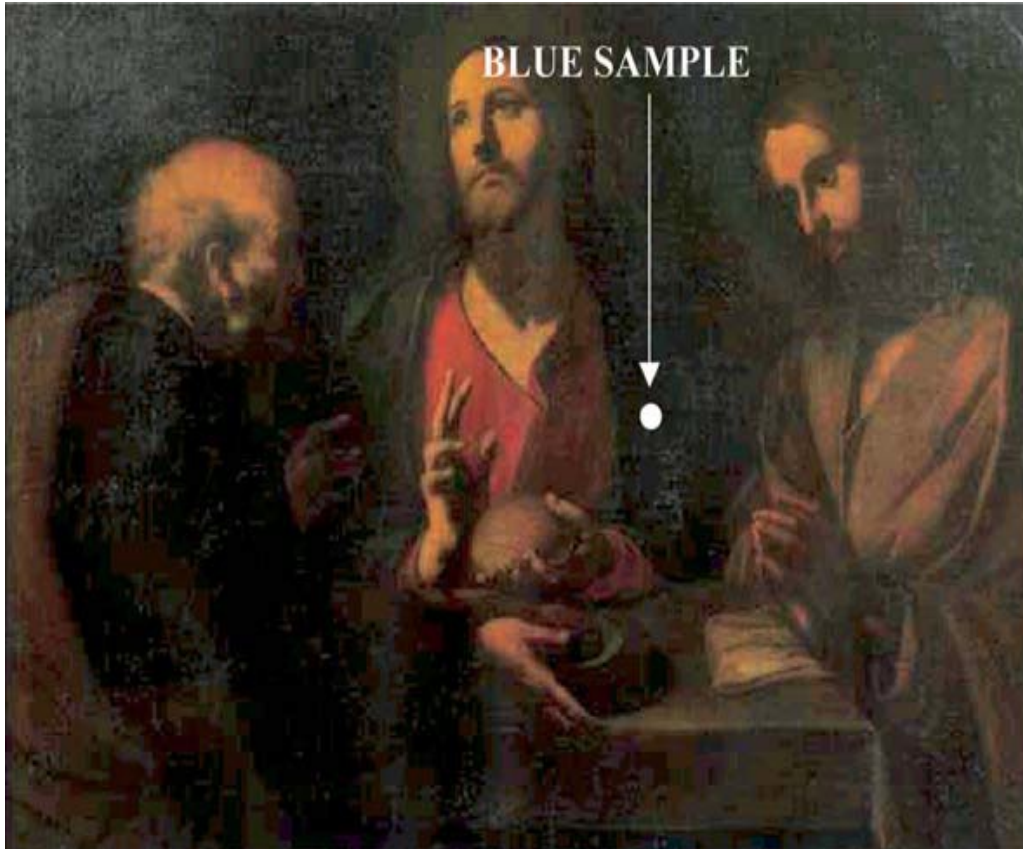
Mayská modř



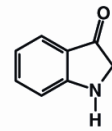
Indigo (or indigotin)



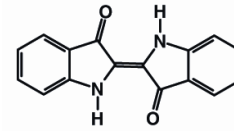
The crystal structure of palygorskite: Projection along the a-direction, showing the various coordination polyhedra above and schematic presentation of the channels in the lattice



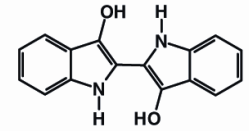
I- indoxyl
1H-ind-3-ol



II- 3-oxindole
(1,2-dihydro-3H-indol-3-one, MW = 133da)

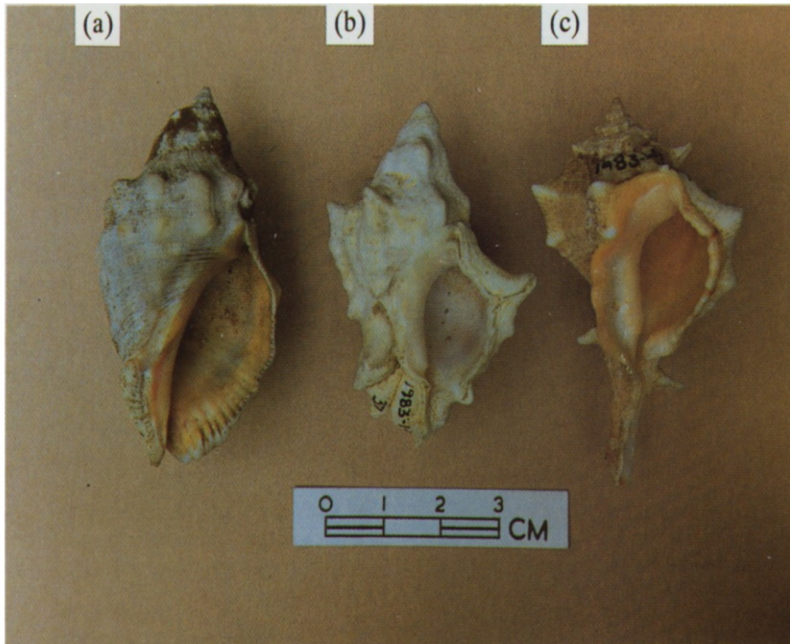


III- indogotine (indigo)
MW = 262 da

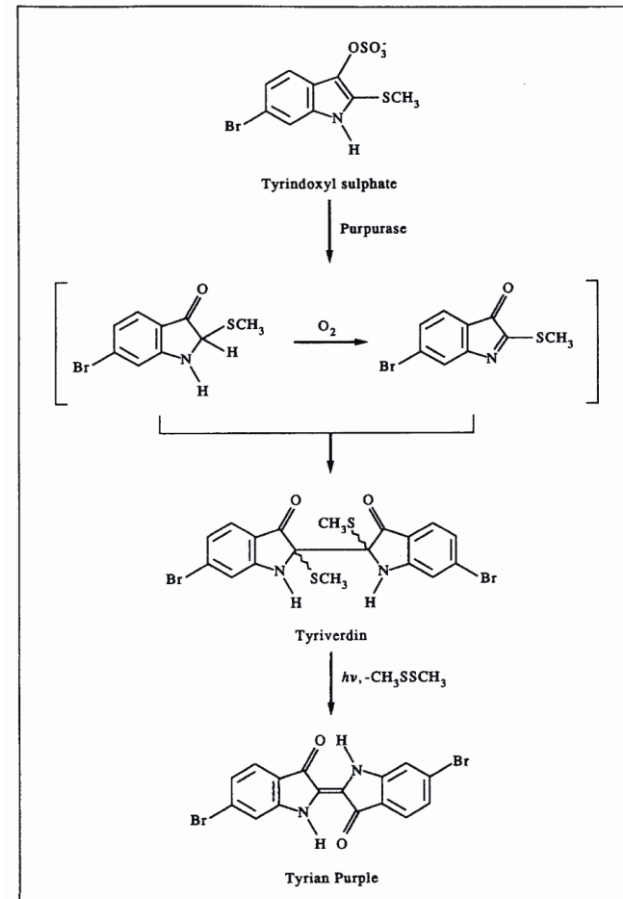


IV- leucoindigo
MW=264 da

Tyrský purpur



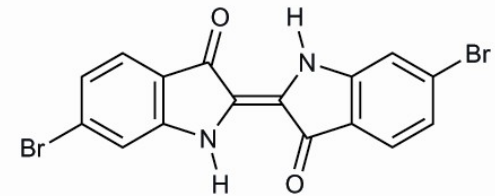
- (a) *Purpura haemostoma*
- (b) *Murex trunculus*
- (c) *Murex brandaris*



Scheme 2 Production of Tyrian Purple from *Murex Brandaris*



Tyrian purple



Details of a mosaic in San Vitale, Ravenna, dating from ca 547 A.D. The mosaic represents the Emperor Justinian wearing a mantle reputedly dyed with Tyrian Purple.

Anthrachinonová barviva

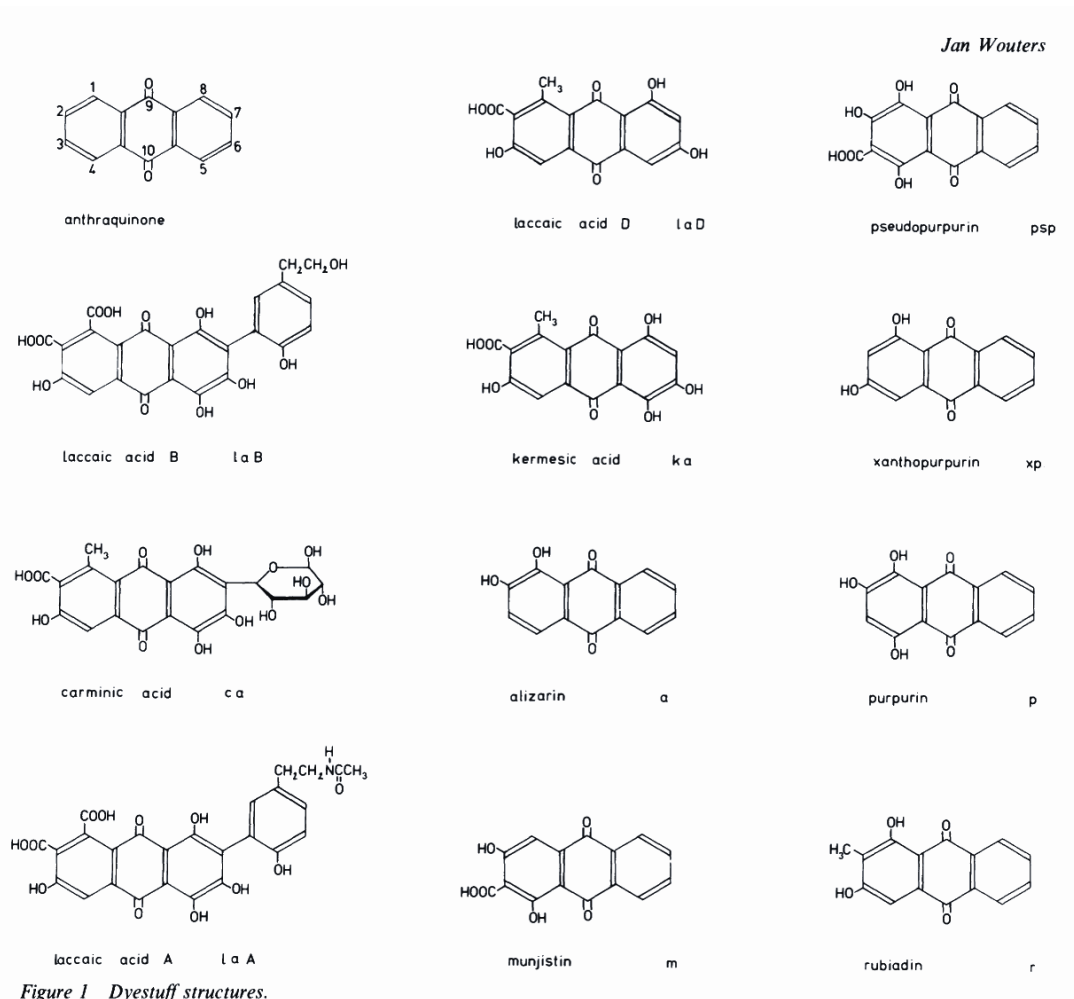


Figure 1 Dyestuff structures.

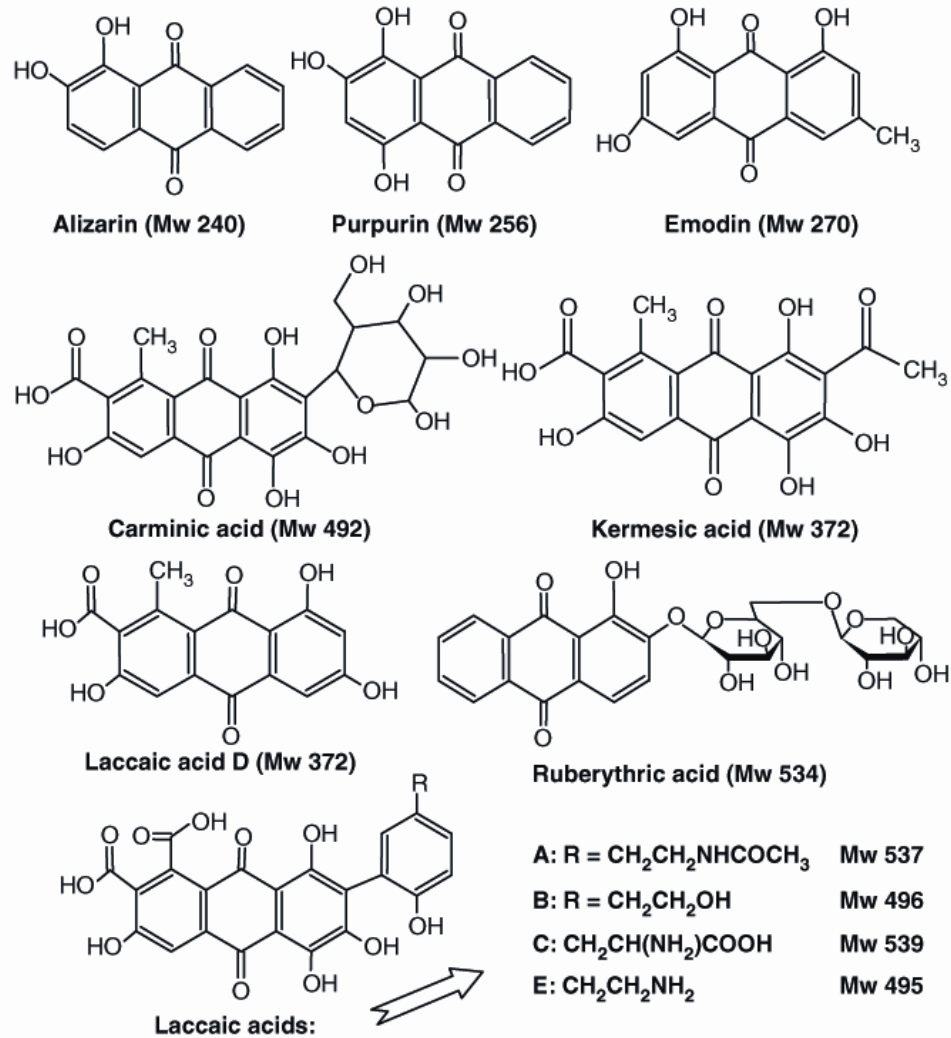


Figure 1. Structures of selected red anthraquinone coloring agents.

Henna

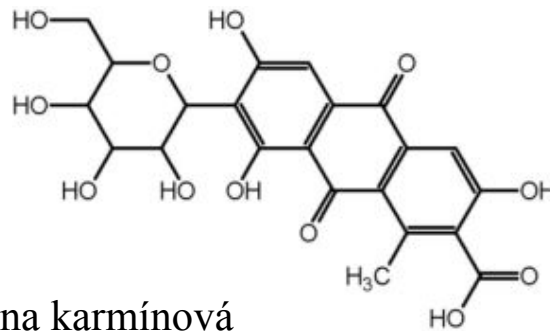


Košenila (karmín)

Tradční červené barvivo předkolumbovského Mexika. Je produkováno červcem nopálovým (*Dactylopius coccus*)



opuncie (*Nopalea coccinellifera*)



Kyselina karmínová

J. Amerika, Mexiko



Kermes

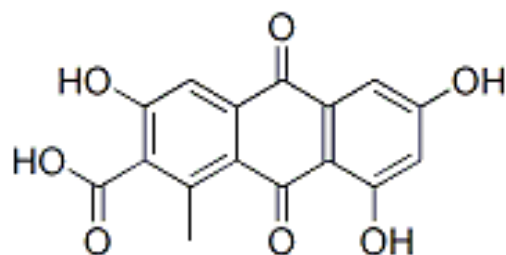
Je produkováno hmyzem *Kermes vermilio*, žijícím na dubu *Quercus coccifera*. Hlavní složku tvoří kyselina karmínová a kermesová. Zmiňuje se už ve Starém zákoně.



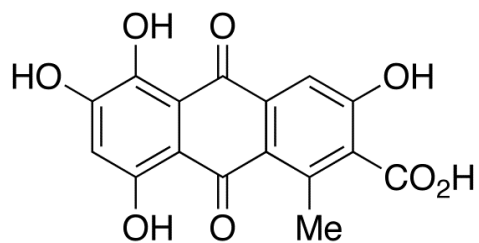
Středomoří, Asie

A kermes-dyed mantle made in Palermo for the Norman King Roger II of Sicily in the 12th century.

Koberec z Pazyryku



Laková kyselina



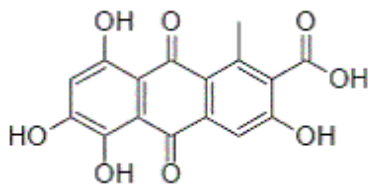
Kermesová kyselina



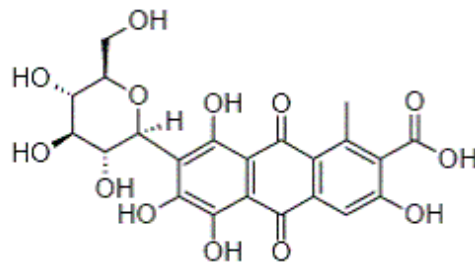
Carpet from Pazyryk - Detail

Polská košenila (polský karmín)

Červené až červenohnědé barvivo. Parazitoval na kořenech některých rostlin v písčitých půdách a sbíral se zejména v Sasku, Prusku, Polsku a Maďarsku. Vyskytoval se hlavně v období kolem svatého Jana Křtitele, podle něhož dostal lidový název svatojánská krev.



kyselina kermesová



kyselina karmínová

červec polský (*Porphyrophora polonica*)



Dračí krev

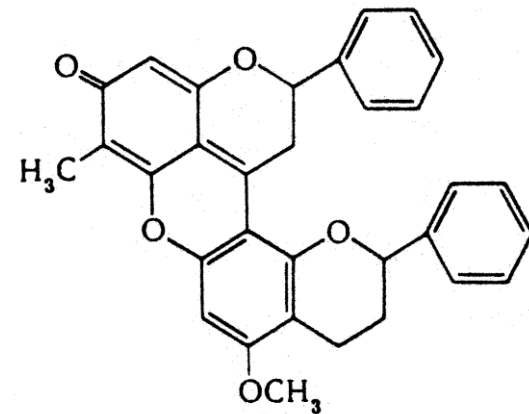
Calamus rotang

Daemonorops draco

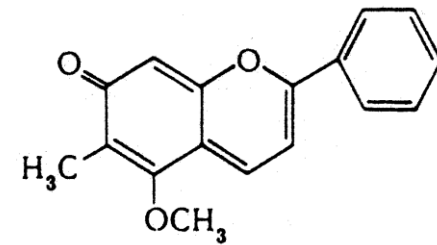
Dracaena cinnabari

Eucalyptus terminalis

+ dalších cca 10 druhů



dracorubin

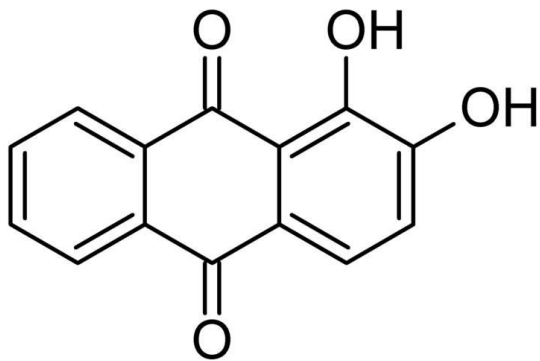


dracorhodin



Alizarin

Mořena barviřská
(*Rubia tinctorum*)



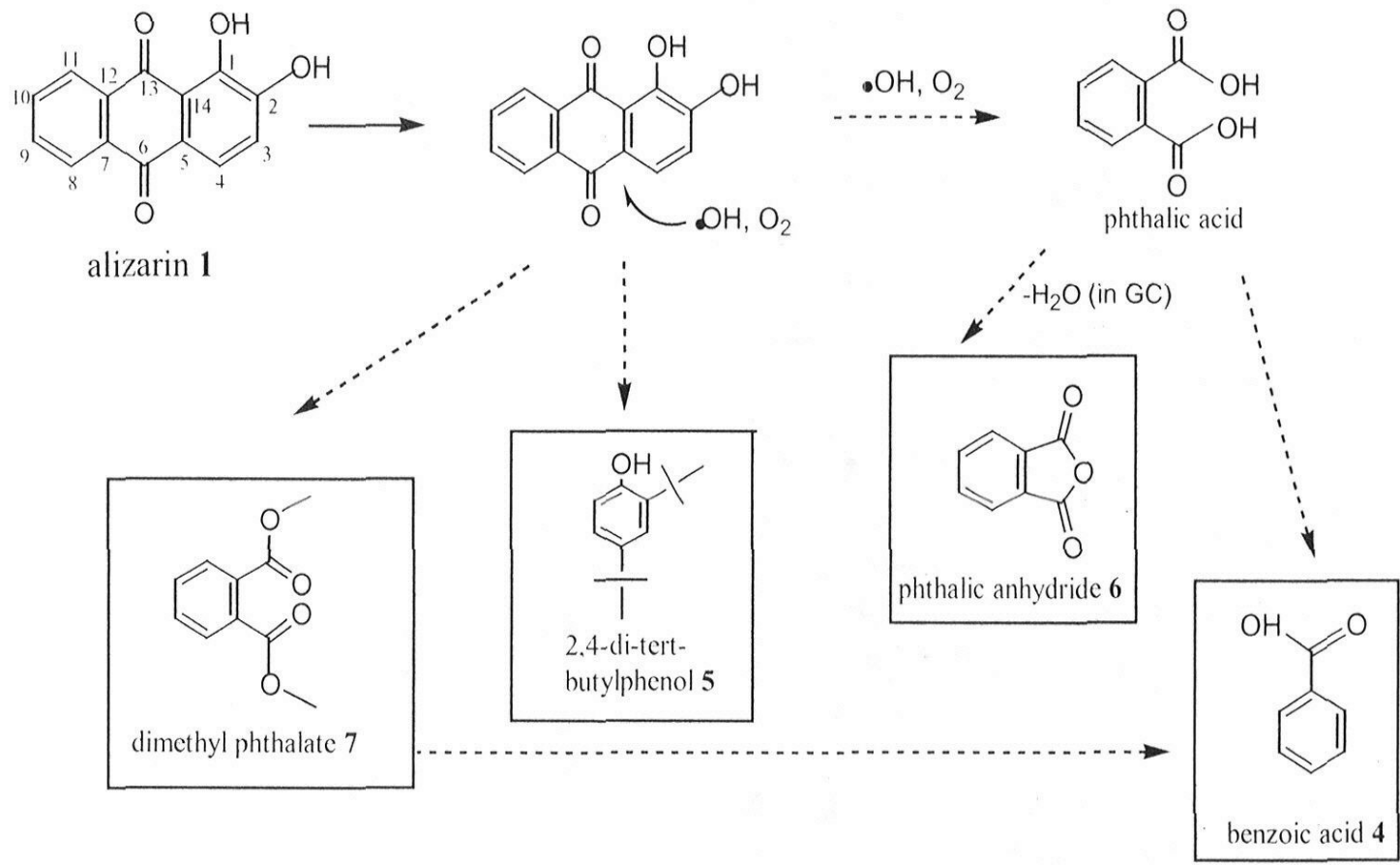
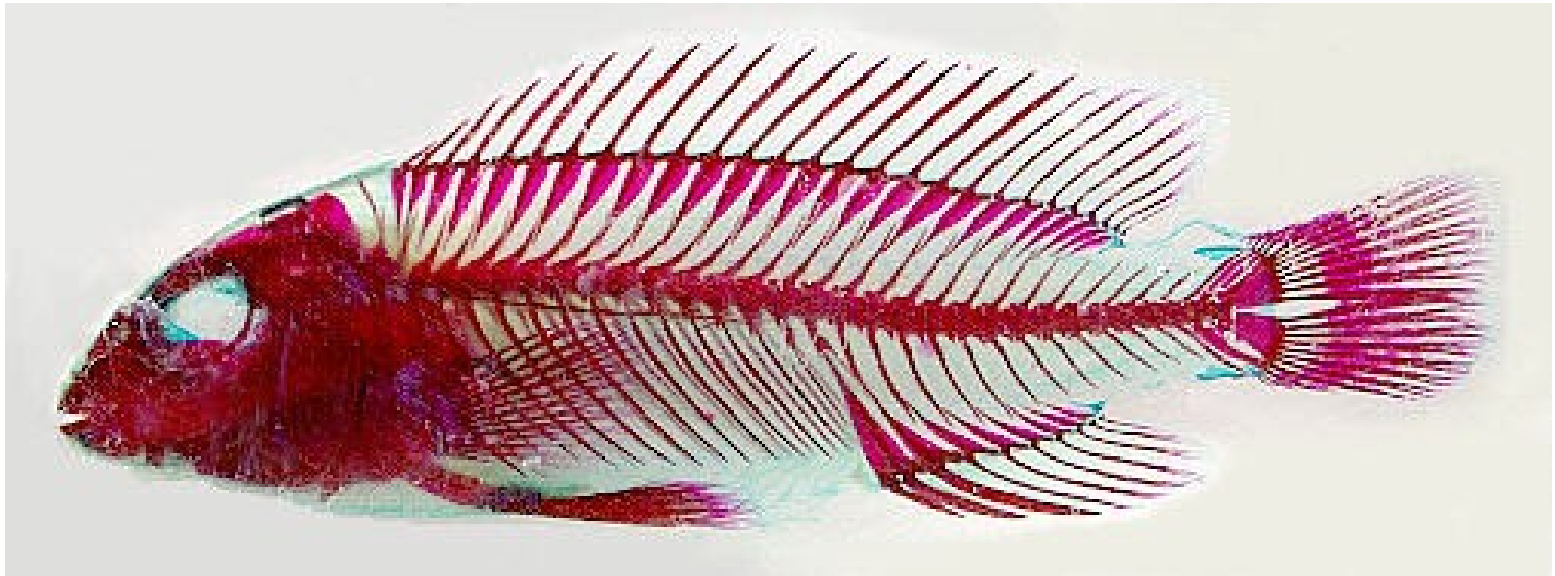


FIGURE 1. Proposed aerobic degradation pathway of alizarin.

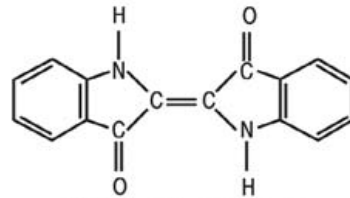
Alizarin

Alizarin má afinitu k vápníku, používá se k barvení kalcifikovaných tkání.



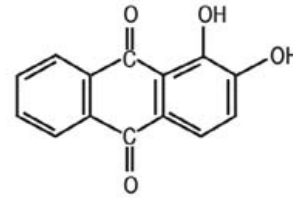
(a) natural dyes

(1) indigo blue



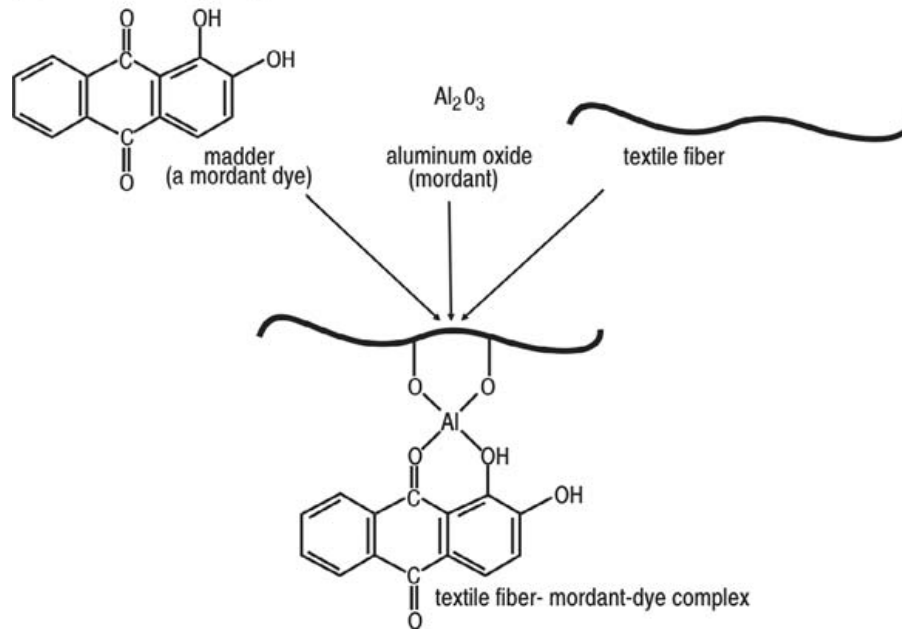
(2,2'-biindoline 3,3'-dione)

(2) madder



1,2 - dihydroxyanthroquinone (alizarine)

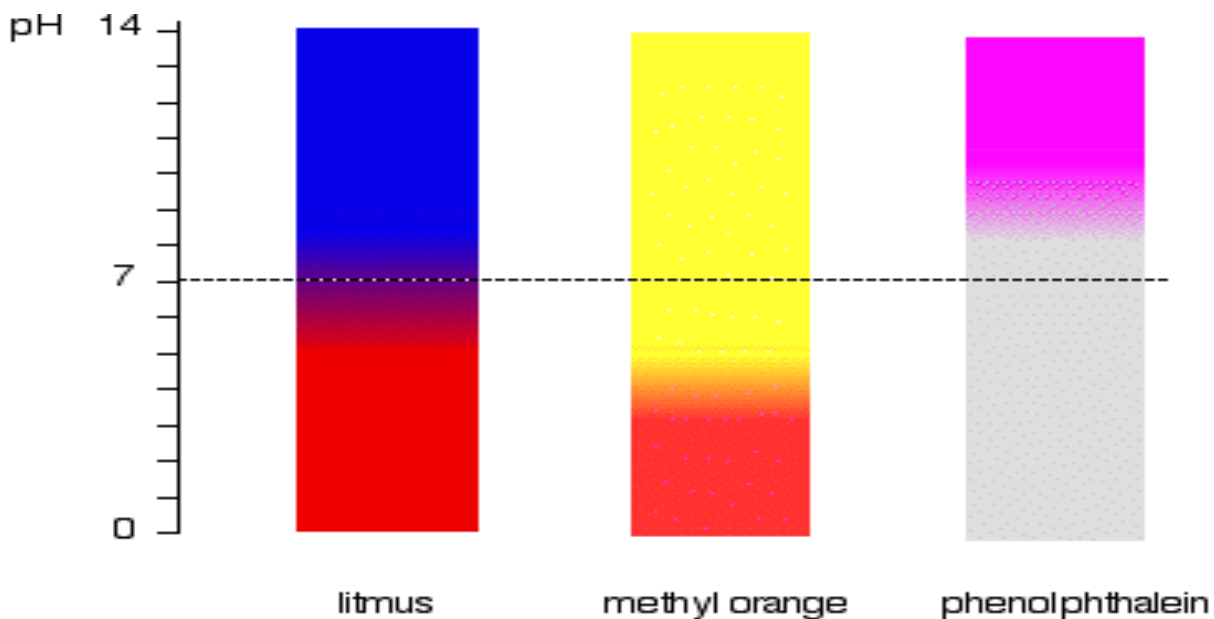
(b) mordant dyeing



Lakmus

= vodou ředitelné barvivo extrahované z určitých druhů lišejníků rodu *Rocella*, používané jako acidobazický indikátor a jako barvivo v potravinářství.

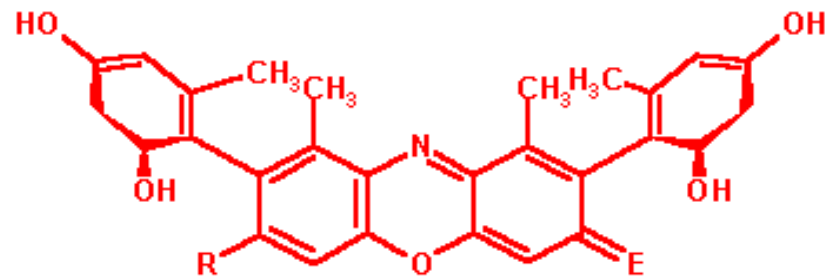
skládá se ze 14 látek



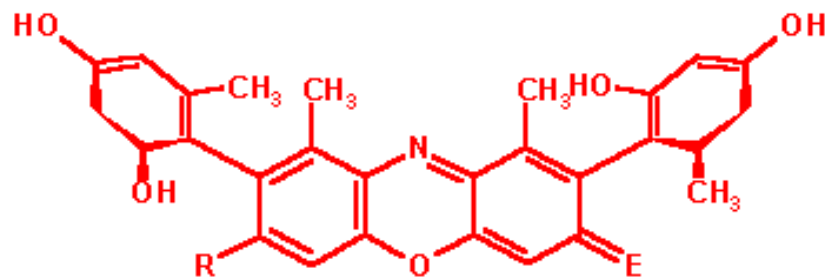
Parmelia sulcata



α -amino-orcein $R=NH_2$
 α -hydroxy-orcein $R=OH$



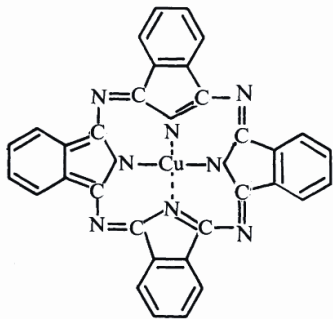
β -amino-orcein $R=NH_2, E=O$
 β -hydroxy-orcein $R=OH, E=O$
 β -amino-orceinimine, $R=NH_2,$
 $E=NH$



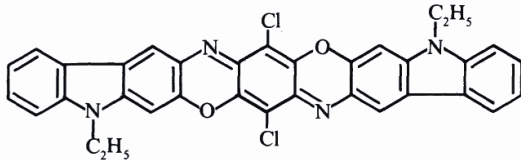
γ -amino-orcein $R=NH_2, E=O$
 γ -hydroxy-orcein $R=OH, E=O$
 γ -hydroxy-orcein, $R=NH_2, E=NH$

Chemical structures of the major components of orchil

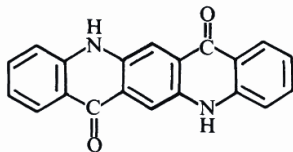
Umělá barviva



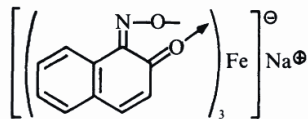
Bleu de phtalocyanine au cuivre PB15



Violet de dioxazine de carbazole PV23



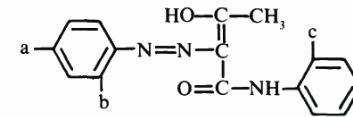
Violet de quinacridone PV19



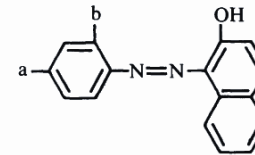
Pigment vert B PG8

Figure 2 Structure chimique de quelques pigments non azoïques.

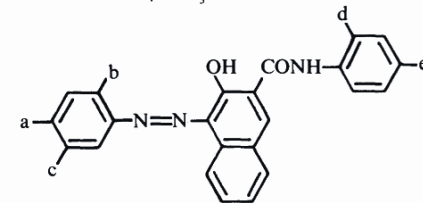
azobarviva



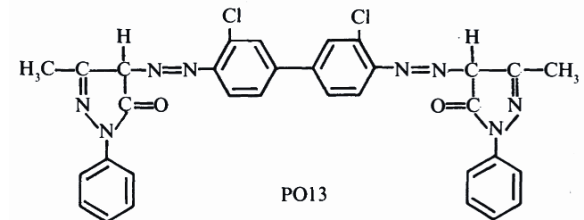
	a	b	c
PY1	CH ₃	NO ₂	
PY3	Cl	NO ₂	Cl
PO1	OCH ₃	NO ₂	CH ₃
PY74	NO ₂	OCH ₃	OCH ₃



	a	b
PO5	NO ₂	NO ₂
PR4	NO ₂	Cl
PR3	CH ₃	



	a	b	c	d	e
PR7	Cl	CH ₃	Cl	CH ₃	Cl
PR9	Cl	Cl	Cl	OCH ₃	
PR12	NO ₂	CH ₃	Cl	CH ₃	
PR112	Cl	Cl	Cl	CH ₃	

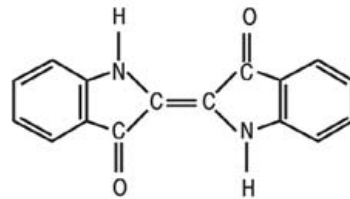


PO13

Figure 1 Structure chimique de quelques pigments azoïques.

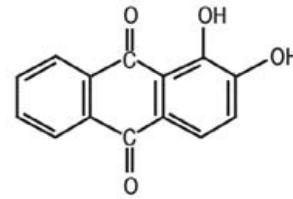
(a) natural dyes

(1) indigo blue



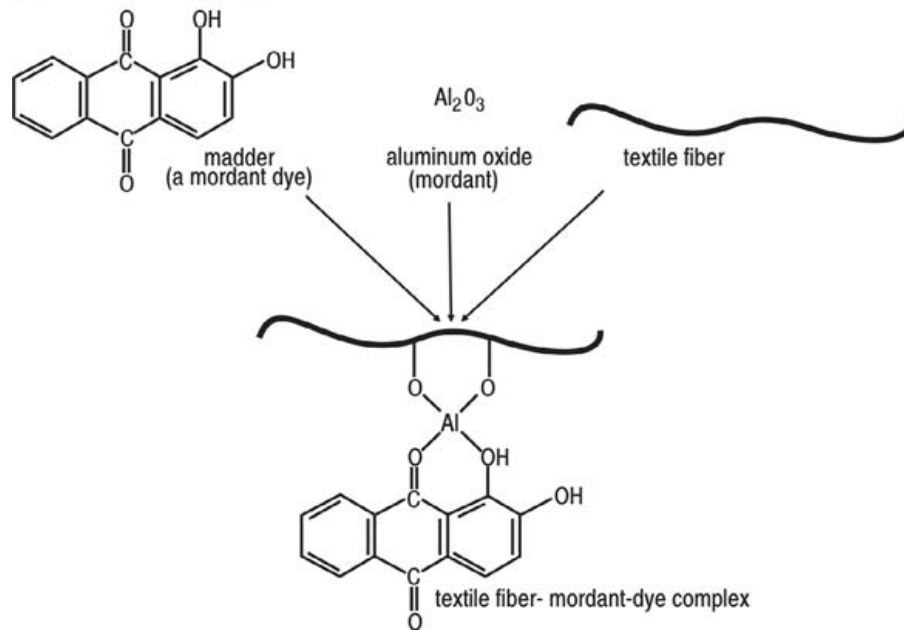
(2,2'-biindoline 3,3'-dione)

(2) madder



1,2 - dihydroxyanthraquinone (alizarine)

(b) mordant dyeing



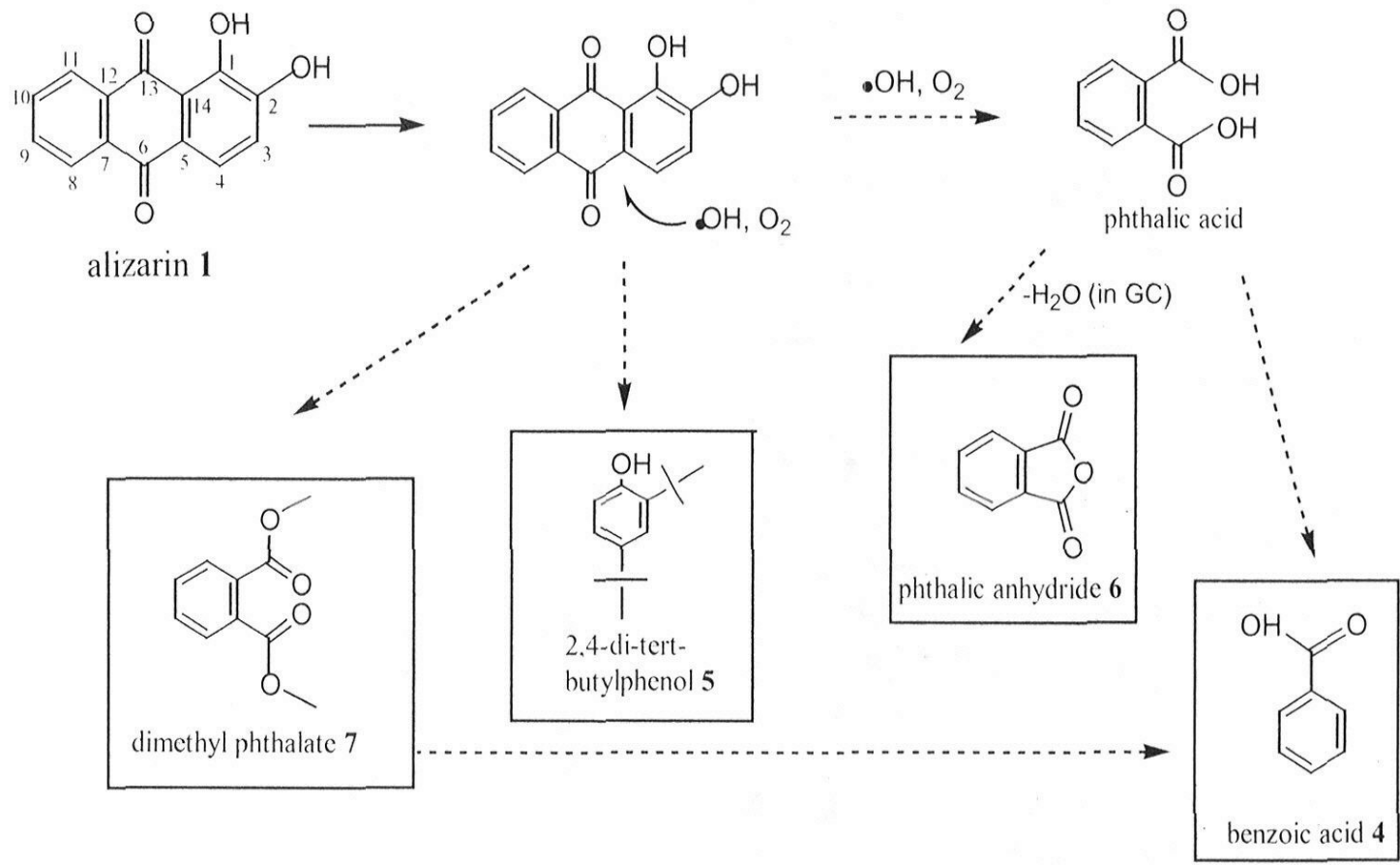


FIGURE 1. Proposed aerobic degradation pathway of alizarin.

Zbarvení kostí vlivem plísní

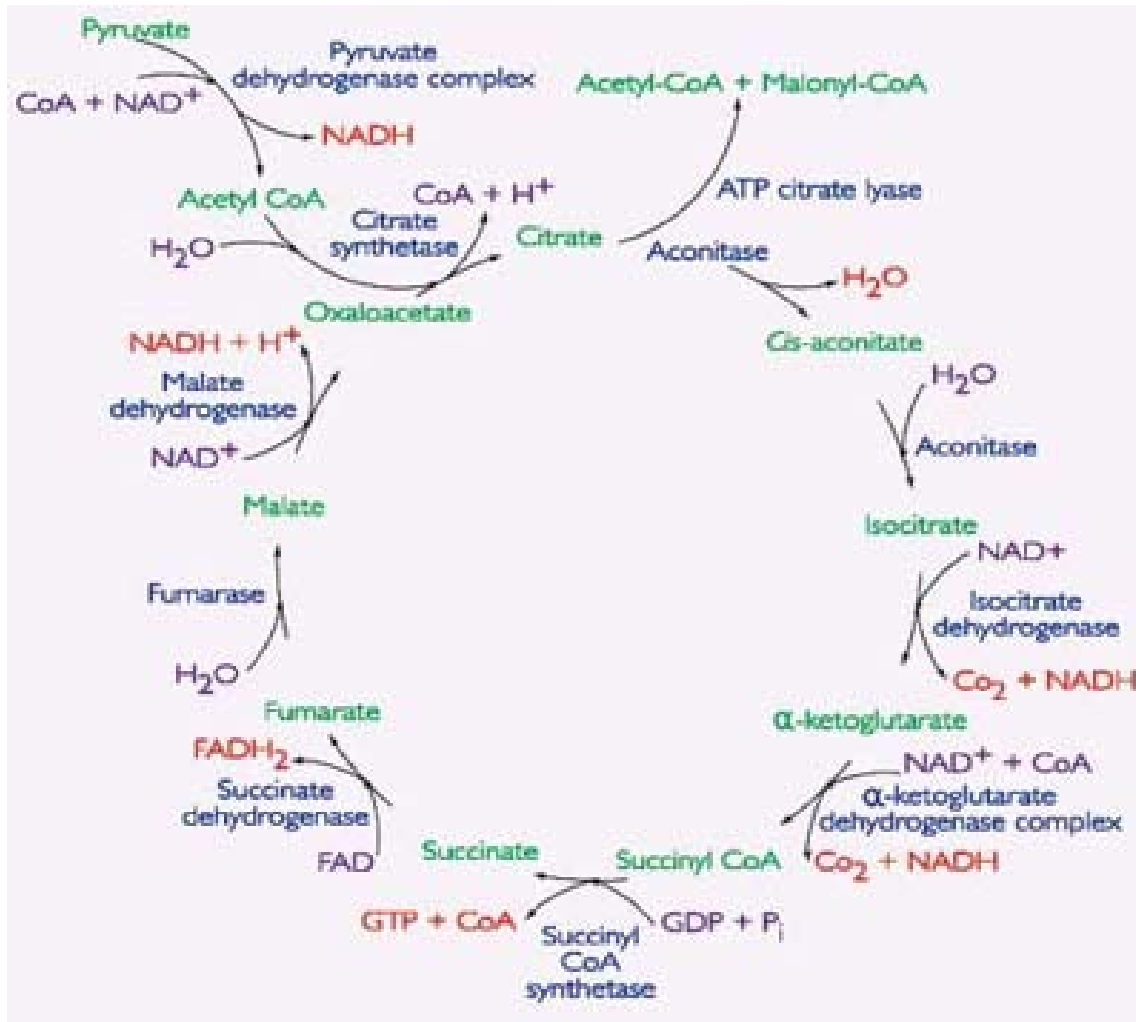
Chemická podstata zbarvení neznámá.

Může být zaměněno za krev nebo druhotné zbarvení vlivem textilií.

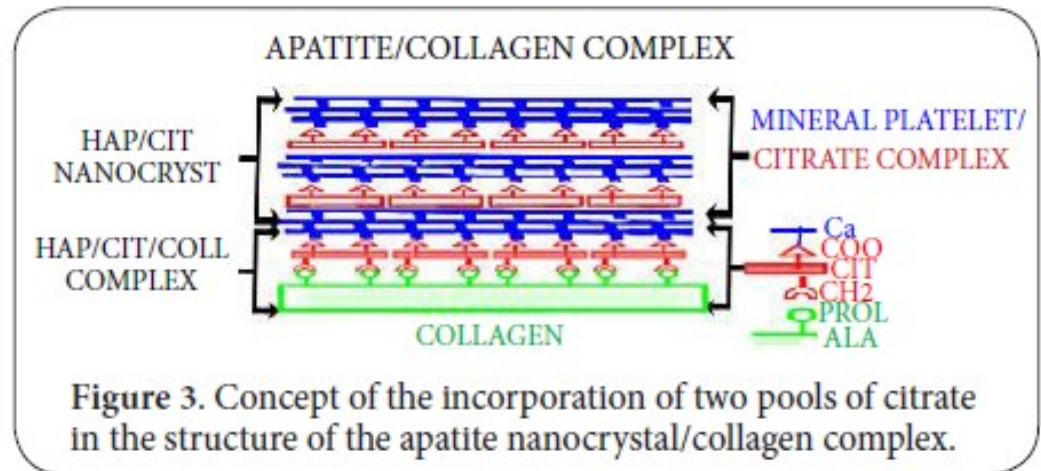
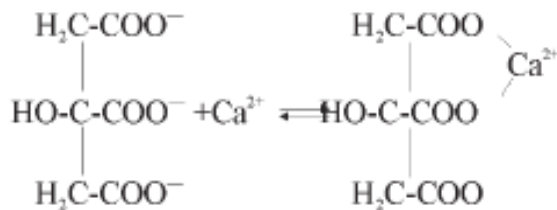
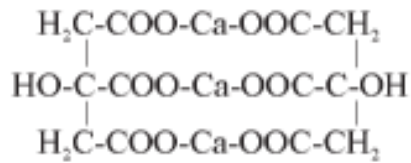
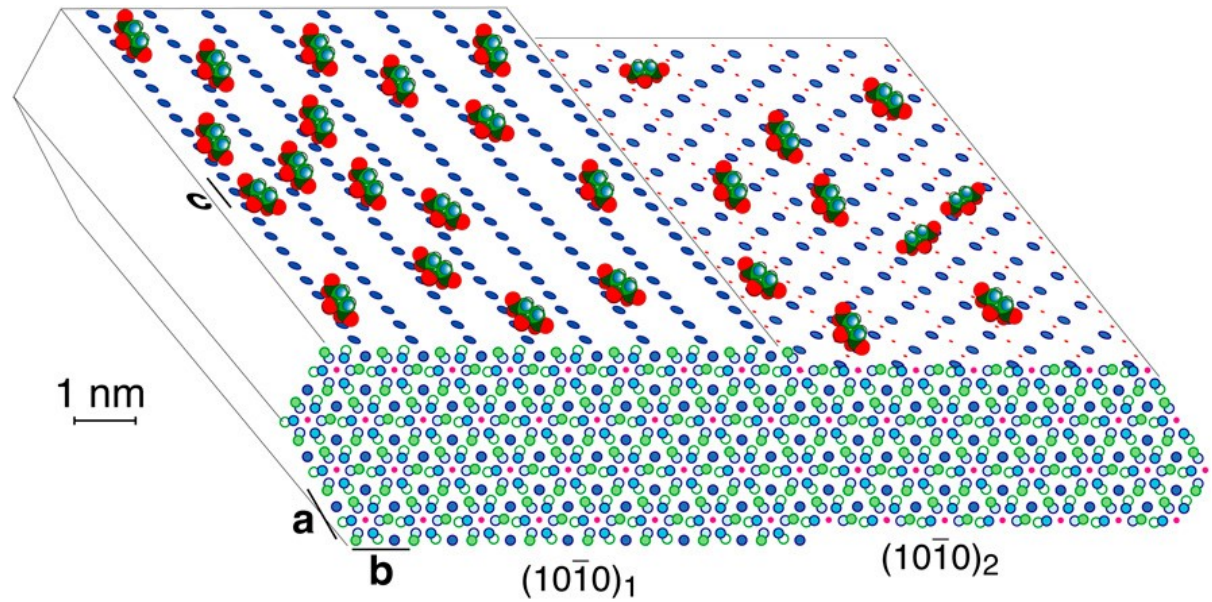
Lebka hr. Raimunda Josefa Dietrichsteina



Metabolismus kyseliny citronové



Vazba citrátu v kosti



Distribuce citrátu v tkáních

Citrate content of teeth

TYPE OF SAMPLE	MG. PER 100 GM. (CITRIC ACID EQUIVALENT)
Whole human teeth.....	680
Human dentin.....	800
Human enamel.....	90
Whole dog teeth.....	510
Dog dentin.....	540
Dog enamel.....	110

Table 1. Bone citrate average ash weight in grams percent (g %)

Animal	N	Citrate ash weight
Fish	2	1.68
Turtle	6	0.29
Frog	4	0.43
Polar Bear	1	2.05
Man	15	1.38
Elephant	1	1.35
Monkey	3	1.04
Cat	1	1.22
Horse	3	1.26
Dog	10	0.96
Cow	5	0.83
Guinea-pig	2	0.95
Rabbit	2	0.82
Rat	12	0.56
Chicken	4	1.09
Goose (feral)	2	0.61
Mean		1.03

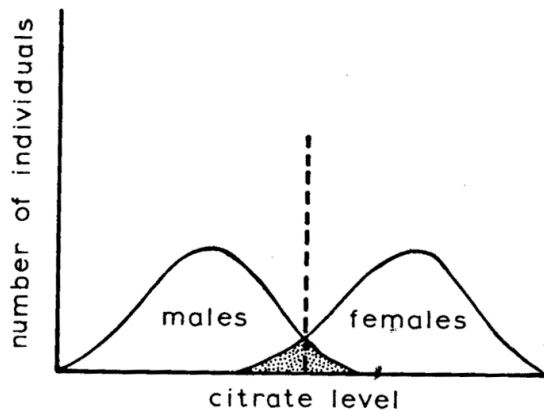
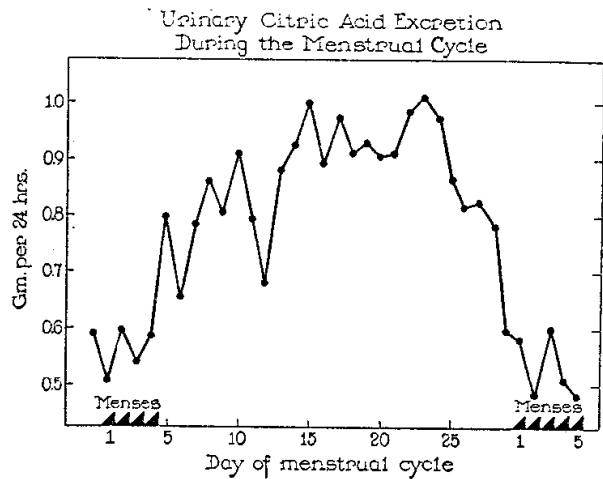
Organic Acids in Beef, Dog, and Rabbit Bones, Egg Shells, and Rat Liver
The values are given in mg. per 100 gm.

Tissue	Type of bone	Organic acid in fresh tissue*				
		Fumaric	Succinic	Aconitic	Malic	Citric
Bone, beef	Cancellous	0.2	1.8	2.7	5.2	475
“ Dog A	Compact	0.2	2.7	3.6	6.6	852
“ “ B	Cancellous	0.2	3.0	3.3	3.9	609
“ “ B	Compact	0.1	1.7	3.8	5.0	966
“ Rabbit A	Cancellous	0.2	1.6	1.6	4.9	553
“ “ B	Compact	0.2	3.6	2.6	6.3	565
“ “ B	Cancellous	0.2	3.1	2.2	5.3	394
“ “ B	Compact	0.2	1.3	3.6	4.6	627
“ “ B	Cancellous	0.2	2.6	2.0	8.0	509
Egg shell A		0.0	0.0	0.0	2.9	66
“ “ B		0.0	0.0	0.0	0.8	11
Rat liver		0.5	2.5	0.1	1.6	3.3

Table 2. Bone citrate levels in the domestic chicken at different reproductive stages

Bone	Citrate ash weight (g %)				
Low-citrate					
Cervical vertebrae	1.90	2.09	1.76	2.00	1.70
Scapula	1.94	1.70	1.76	2.01	1.79
Coracoid	1.72	1.71	1.87	1.93	1.71
Humerus	1.57	1.53	1.46	1.72	1.36
Radius	1.69	1.55	1.55	1.72	1.87
Ulna	1.41	1.38	1.36	1.55	1.55
Carpometacarpus; phalanges	1.83	1.60	1.51	1.77	1.61
Femur	1.59	1.40	1.32	1.46	1.42
Tibiotarsus	1.61	1.43	1.47	1.67	1.59
Tarsometatarsus	2.02	1.75	1.65	2.10	1.81
High-citrate					
Skull	2.36	2.58	2.21	2.68	2.54
Ribs	2.51	2.28	2.22	2.49	1.96
Sternum	2.71	2.47	2.62	2.87	2.30
Pelvis	2.76	2.29	2.30	2.45	2.16
Foot phalanges	2.49	2.30	2.37	2.72	2.60
Mean	2.01	1.87	1.83	2.07	1.86

Pohlavní rozdíly v obsahu citrátů



-Normal distribution curves of citrate levels (g.%) showing sexual separation.

ZITRATGEHALT IM GEWICHTPROZENT

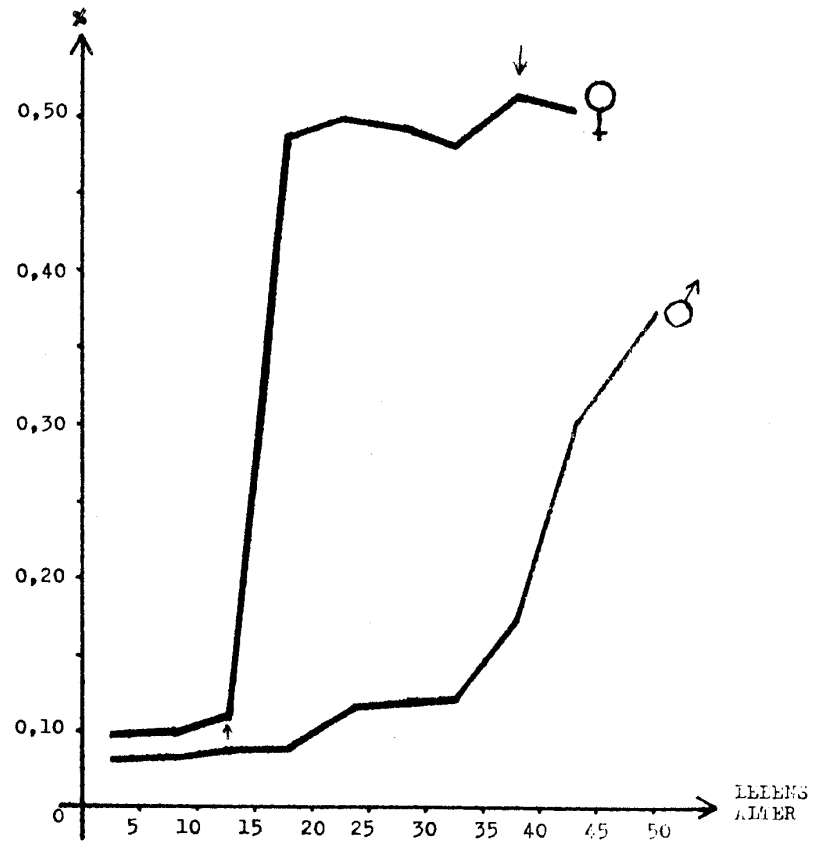


Abb. 2.

Änderungen des Zitratgehaltes vom Knochengewebe in der Verteilung nach Geschlechtes und Altersunterschieden.

Vliv diagenese

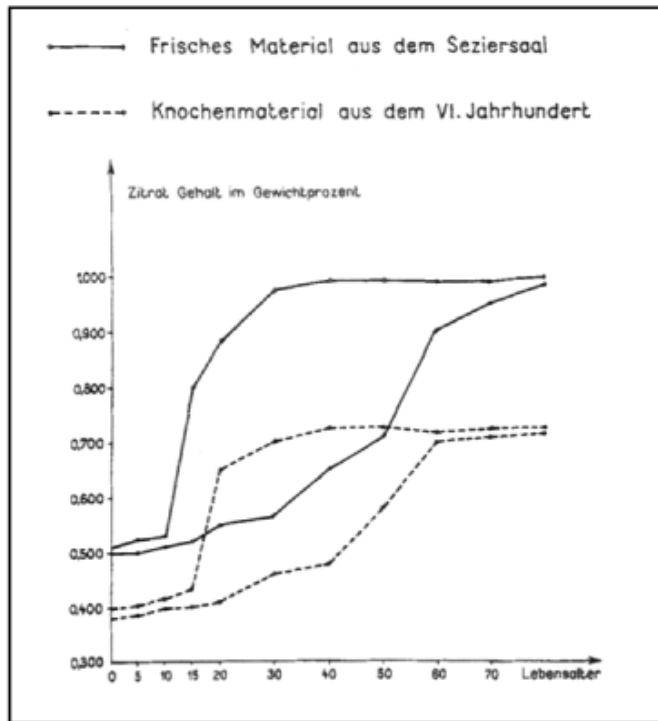


Abbildung 3: Veränderungen des Zitratgehaltes in Abhängigkeit von Geschlecht, Lebensalter und Liegezeit (aus LENGYEL 1972)

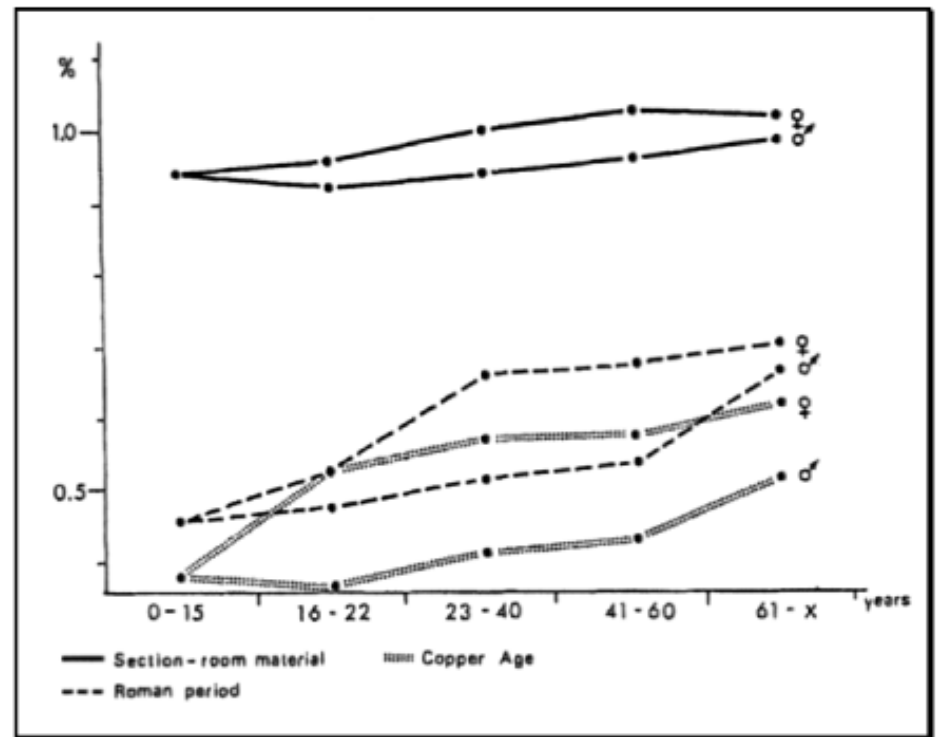


Abbildung 1: Veränderungen des Zitratgehaltes in Abhängigkeit von Geschlecht, Lebensalter, Herkunft und Liegezeit (aus LENGYEL, in BROTHWELL 1968)

Table 7. Citrate preservation in prehistoric mammoth preserved under various conditions compared to modern elephant values (g %)

	Modern elephant	Mammoth			
		In ice	Permafrost	Tar pit	Fossil
Citrate	1.35	0.05	1.43	0.05	0.03
Hydroxyproline	2.89	2.56	2.54	2.23	0.00

Určení pohlaví spálených kosterních pozůstatků

Frisches Material	2. Jt. n. Chr.	Deutschland	0,52%	1,04%
Grödig	6./7. Jh. n. Chr.	Österreich	0,56%	0,86%
Pleidelsheim	5.-7. Jh. n. Chr.	Deutschland	0,42%	0,77%
Kamid el-Loz	5./4. Jh. n. Chr.	Libanon	0,33%	0,58%
Münster-Gittrup	ca. 1 Jt. v. Chr.	Deutschland	0,26%	0,53%
Trebur-Hinkelstein	5. Jt. v. Chr.	Deutschland	0,21%	0,40%
Trebur-Großgartach	5. Jt. v. Chr.	Deutschland	0,24%	0,42%

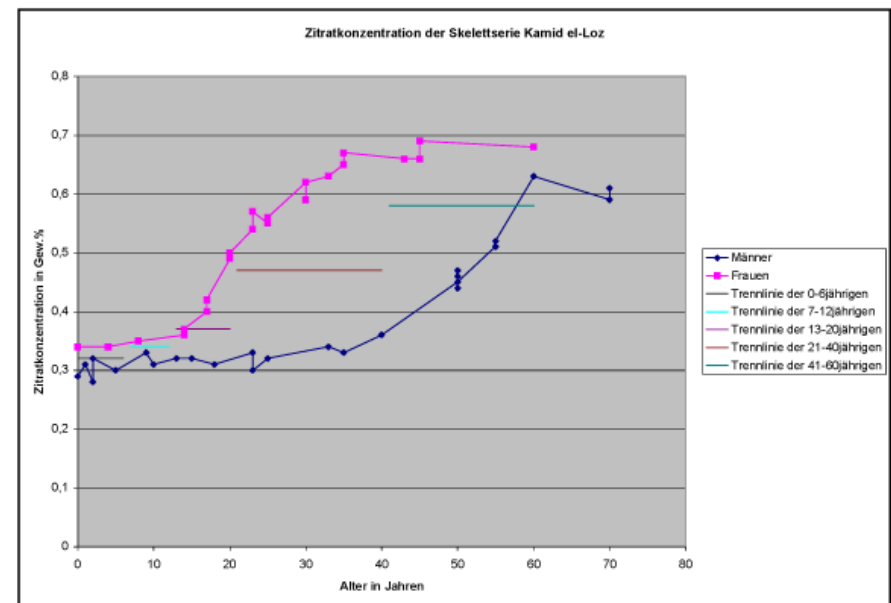
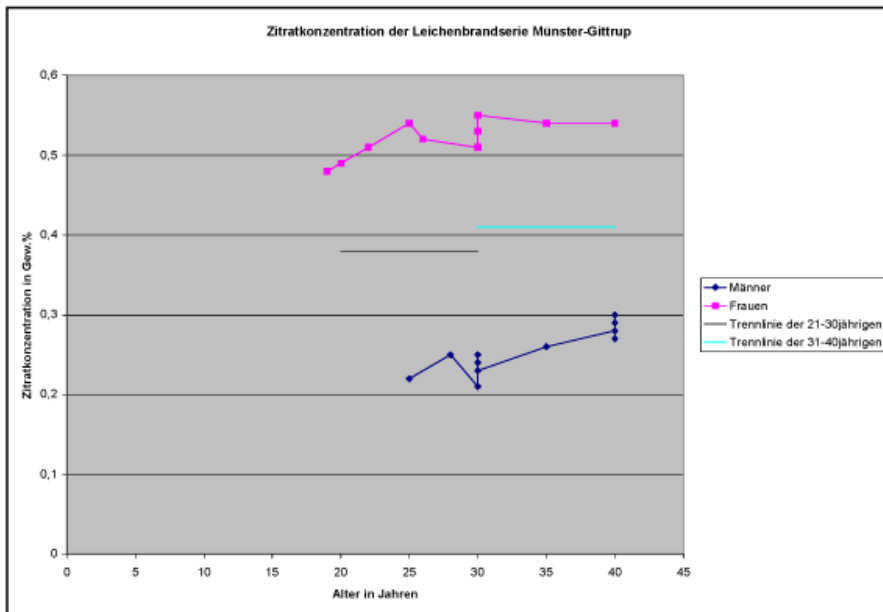


Abbildung 26: Zitratkonzentration des Knochenmaterials der Leichenbrandserie Münster-Gittrup in Abhängigkeit von Lebensalter und Geschlecht

Abbildung 25: Zitratkonzentration des Knochenmaterials der Skelettserie Kamid el-Loz in Abhängigkeit von Lebensalter und Geschlecht

Porównanie wyników określenia płci i wieku szczątków ciała palnych metodą morfologiczną i biochemiczną

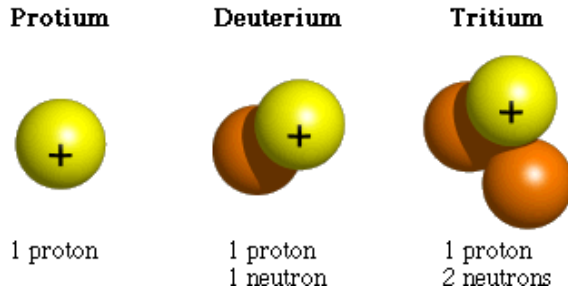
Lp.	Stopień spalenia kości	Nr grobu	Całkowita ilość materiału	Kompleks białkowo-wielocukrowy w mg%	Grupy krwi	Zawartość kwasu cytrynowego w mg%	Płeć	Płeć (morfolog.)	CO ₃ g%	Ca g%	PO ₄ ³⁻ P g% (x3)	Kollagen kostny g%	Wiek biologiczny	Wiek określony metodą morfologiczną	
1	2	3	4	5	5	7	8	9	10	11	12	13	14	15	
1	miernie	1	11,5	Tylko ślady, poniżej 0,010 mg%	Brak pozytywnej reakcji we wszystkich przypadkach	0,61	K	?	1,65	23,90	4,10	2,15	40—50	Ad/Mt?	
2	d. silnie	2	2,1			0,18	?	?	0,60	27,15	5,40	2,00	5—10	Inf. I.	
3	d. silnie	3	5,5			0,20	?	?	0,55	21,10	6,50	1,70	0—5	Inf. I.	
4	miernie	4-a	11,0			0,67	K	M	0,90	22,60	5,00	2,05	25—35	Ad?	
	miernie	4-b	4,3												
5	miernie	5	10,2			0,23	M	K?	1,15	23,15	3,90	2,10	45—55	Jv?	
6	d. silnie	6	6,4			0,63	K	?	0,65	21,60	5,15	1,85	5—15	Inf. I.	
7	d. silnie	8	10,6			0,16	?	?	0,60	22,00	5,35	1,80	5—10	Inf. I.	
8	miernie	12	9,6			0,54	?	?	0,95	22,05	4,80	2,00	30—40	Inf. I.	
9	d. silnie	13	7,0			0,60	K	?	0,75	23,15	5,05	2,00	15—20	Inf. I.	
10	d. silnie	15	14,2			0,65	K	?	0,90	23,50	4,95	2,10	25—35	Jv/Ad?	
11	miernie	16	12,1			0,35	M	M	0,85	22,80	5,10	2,05	20—30	Jv	
12	miernie	17-a	5,3			0,30	M	?	0,80	23,30	5,05	2,30	20—30	Inf. I.	
	miernie	17-b	4,5												
13	miernie	18	7,3			0,40	M	K	0,95	23,45	4,60	2,10	35—45	Jv?	
14	d. silnie	19	14,1			0,60	?	?	1,60	23,85	4,15	2,00	40—50	Jv	
	miernie	20-1	11,0												
15	miernie	20-2	6,5			0,31	M	M	1,95	23,60	3,90	1,90	45—55	Jv/Ad	
	miernie	20-3	8,2												
16	miernie	21-1	9,5			0,68	K	K?	0,95	23,95	4,50	2,15	35—45	Inf. II/Jv	
	miernie	21-2	7,2												
17	miernie	22-1	5,1			0,37	M	K	0,80	23,20	4,75	2,10	30—40	Ad	
	miernie	22-2	8,3				?	?							
18	miernie	24	7,0			0,62	K	K?	0,75	22,90	4,90	2,10	25—35	Ad	
19	slabo	26	12,2	0,41	M	K?	1,95	21,60	3,60	2,00	50—60	Jv/Ad			
20	slabo	27	14,2	0,43	M	M	1,90	21,45	3,40	1,80	50—60	Ad?			
21	miernie	30	17,1	0,44	M	?	0,70	23,30	5,00	2,60	25—35	Inf. I.			
22	miernie	31	10,5	0,67	K	K?	1,10	22,90	4,00	2,00	45—55	Inf. II/Jv			
23	miernie	32	8,3	0,64	K	?	1,90	21,85	3,45	2,00	50—60	Inf. I.			
24	miernie	33	16,1	0,40	M	M	1,85	21,50	3,60	1,70	50—60	Jv			

Izotopy

Izotopy v přírodě



The Nuclei of the Three Isotopes of Hydrogen



$$\delta^{13}\text{C} = \left[\frac{(^{13}\text{C}/^{12}\text{C})_{\text{Sample}}}{(^{13}\text{C}/^{12}\text{C})_{\text{Standard}}} - 1 \right] \times 1000$$

$$\delta^{15}\text{N} = \left[\frac{(^{15}\text{N}/^{14}\text{N})_{\text{Sample}}}{(^{15}\text{N}/^{14}\text{N})_{\text{Standard}}} - 1 \right] \times 1000$$

Element	Stable Isotopes	Abundance (%)*
Hydrogen	¹ H (H)	99.985
	² H (D)**	0.015
Carbon	¹² C	98.892
	¹³ C	1.108
Nitrogen	¹⁴ N	99.635
	¹⁵ N	0.365
Oxygen	¹⁶ O	99.759
	¹⁷ O	0.037
	¹⁸ O	0.204
Sulfur	³² S	95.0
	³³ S	0.75
	³⁴ S	4.21
	³⁶ S	0.014

*Abundance does not sum to 100% because radioisotopes are omitted from this table

**D = deuterium, ²H:¹H is often given as D:H

Fotosyntéza

C3 rostliny

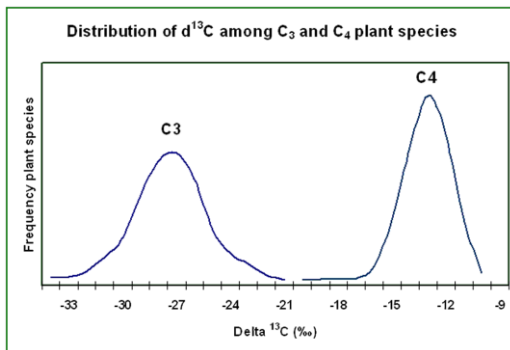
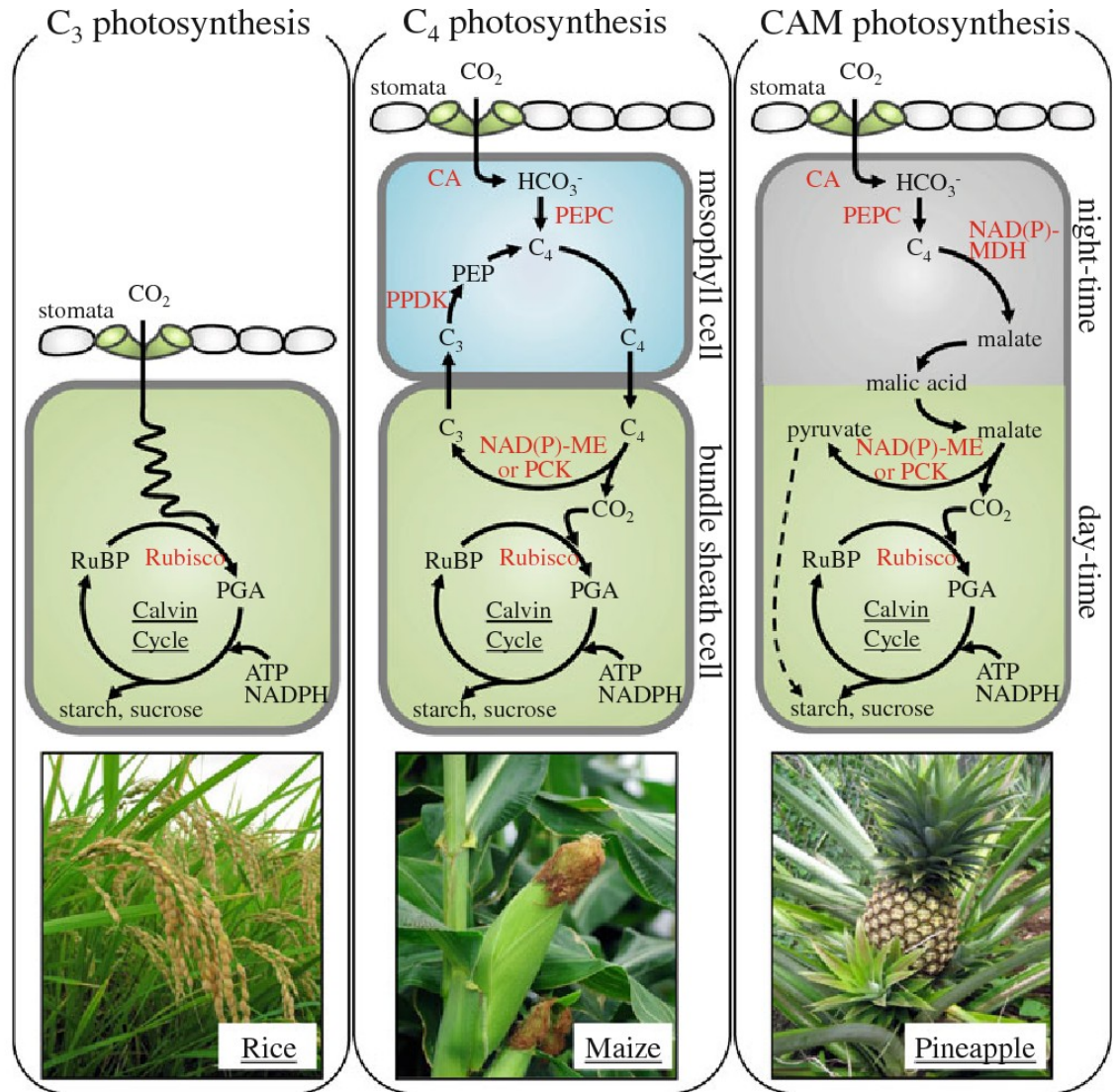
ječmen, pšenice,
brambory, cukrová řepa,

C4 rostliny

kukuřice, cukrová třtina

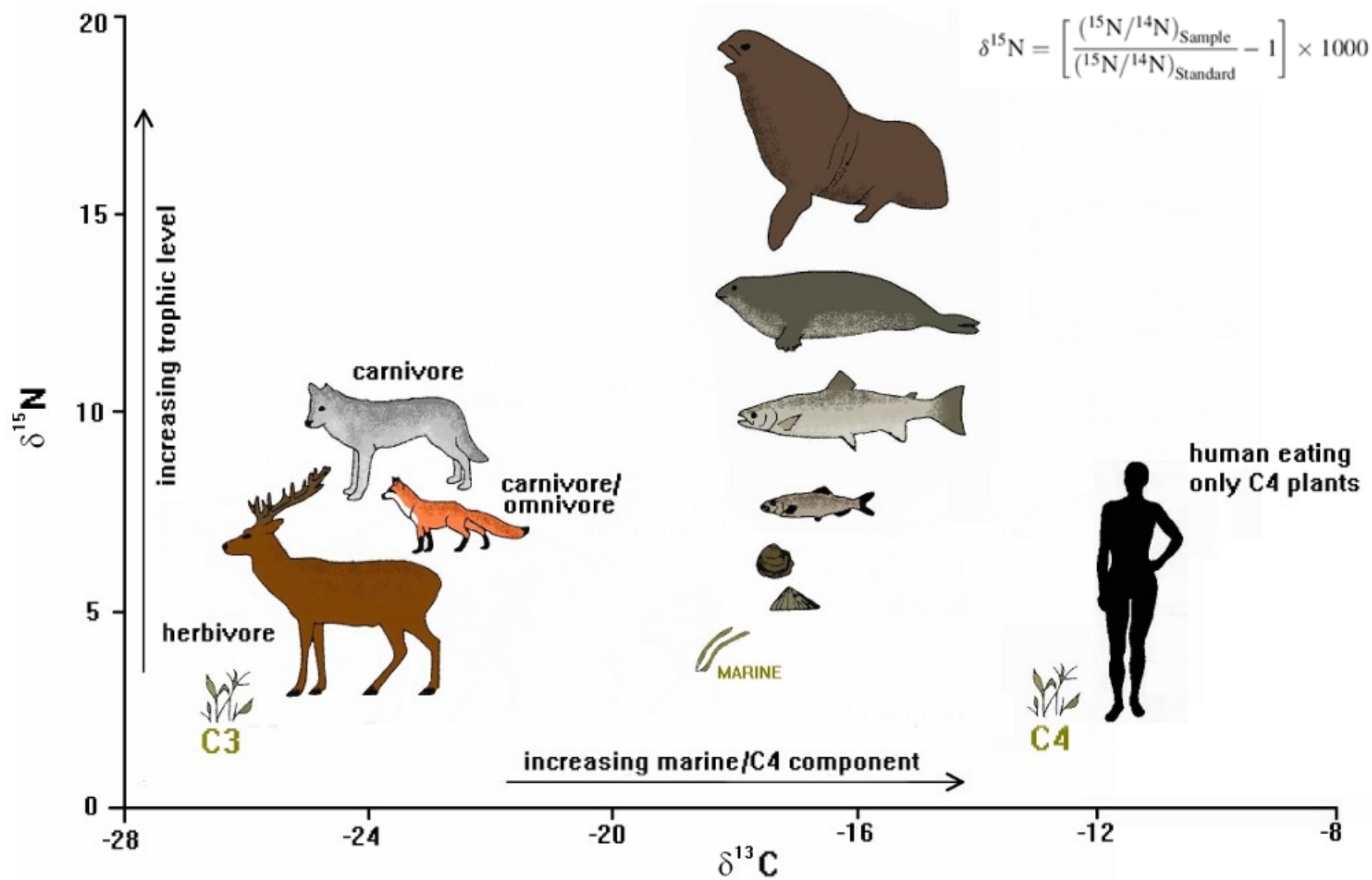
CAM rostliny

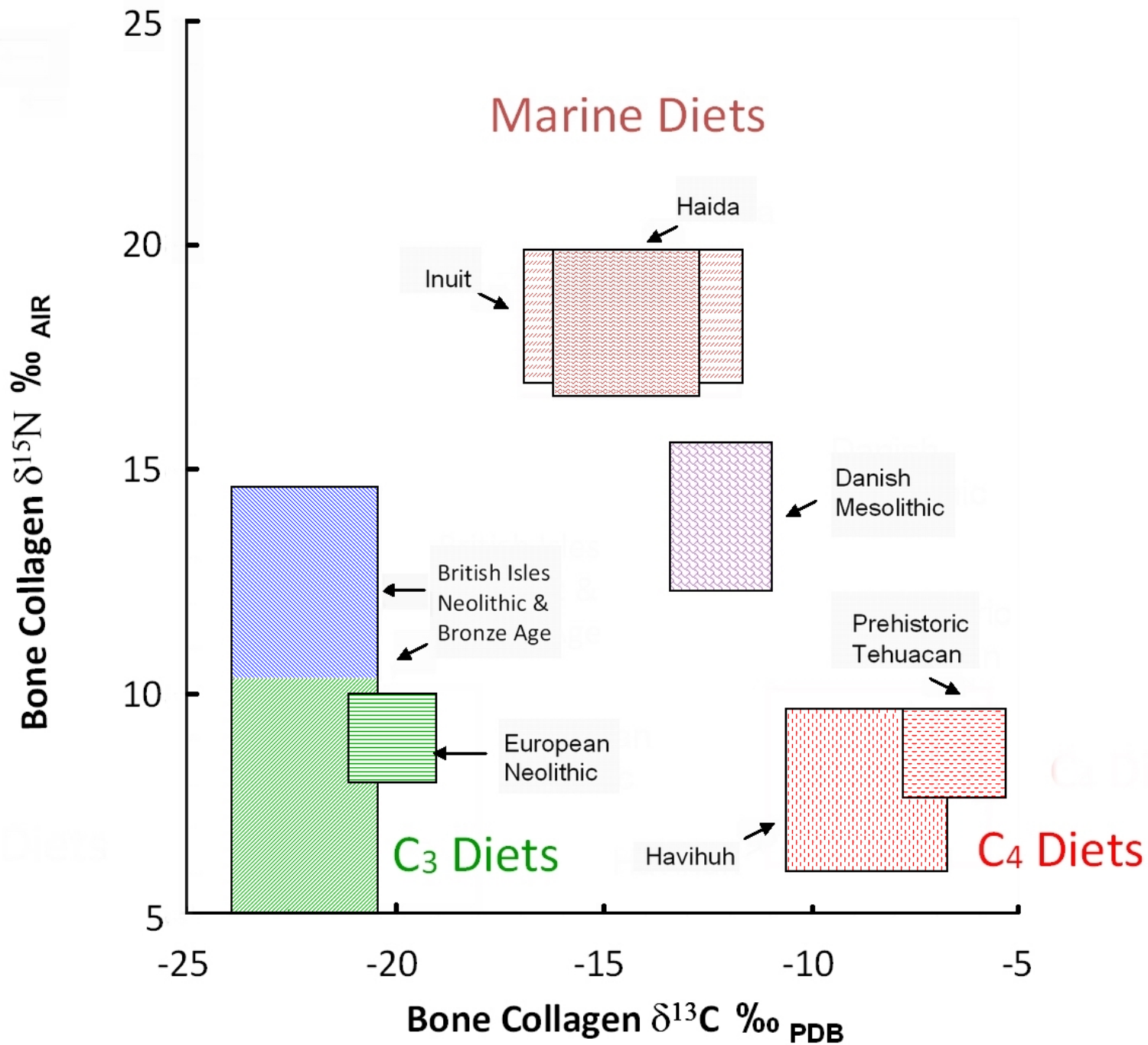
ananas, sukulenty

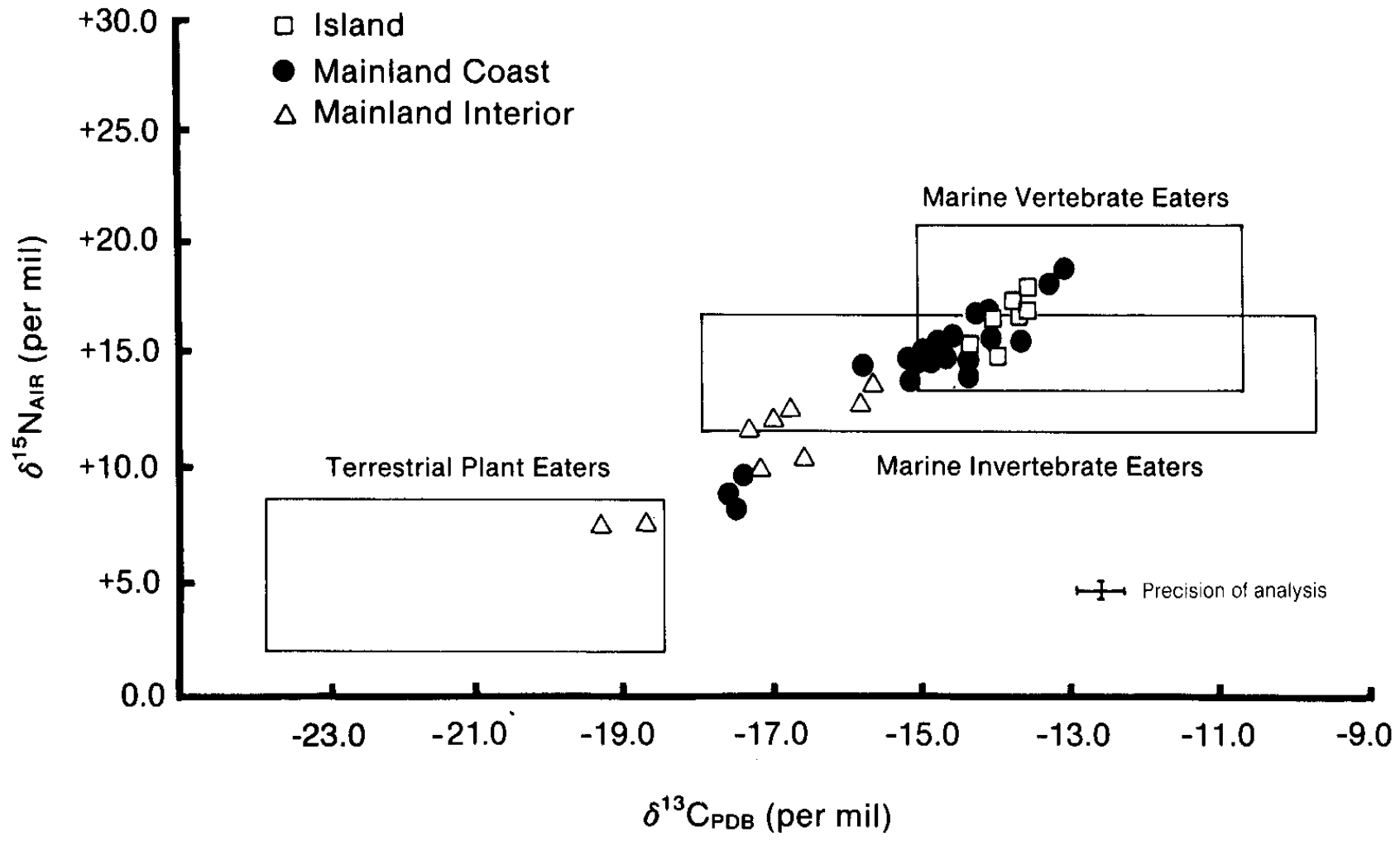


$$\delta^{13}\text{C} = \left[\frac{(^{13}\text{C}/^{12}\text{C})_{\text{Sample}}}{(^{13}\text{C}/^{12}\text{C})_{\text{Standard}}} - 1 \right] \times 1000$$

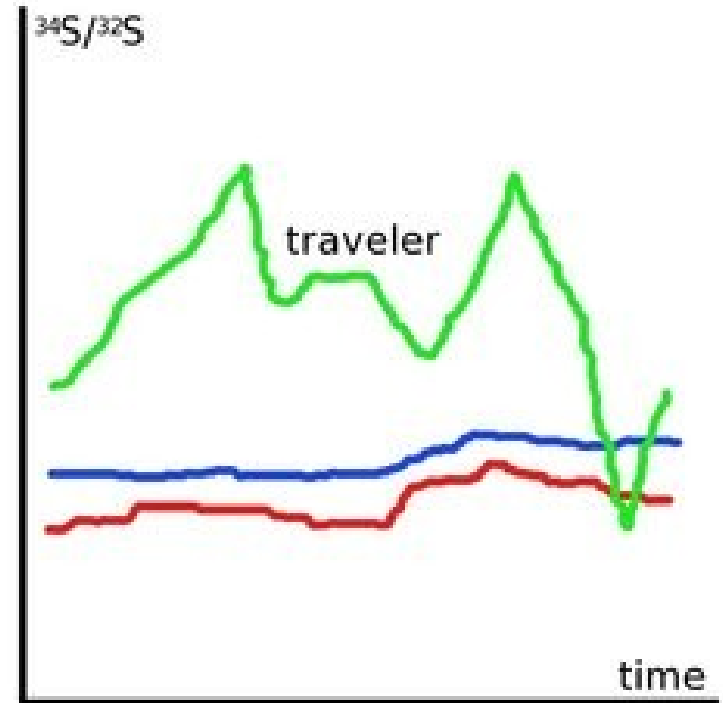
$$\delta^{15}\text{N} = \left[\frac{(^{15}\text{N}/^{14}\text{N})_{\text{Sample}}}{(^{15}\text{N}/^{14}\text{N})_{\text{Standard}}} - 1 \right] \times 1000$$





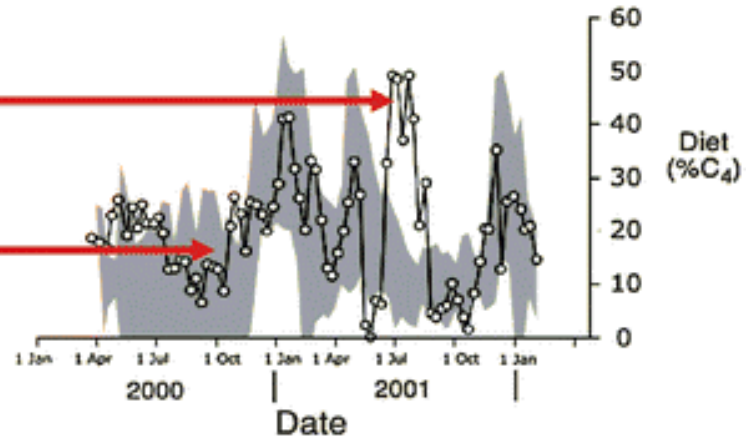
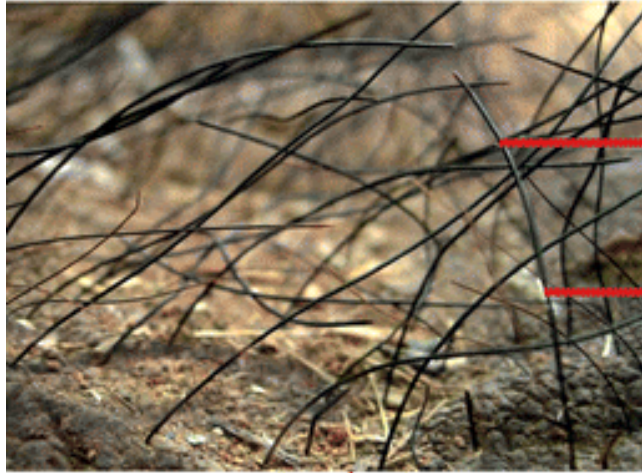


Keratin

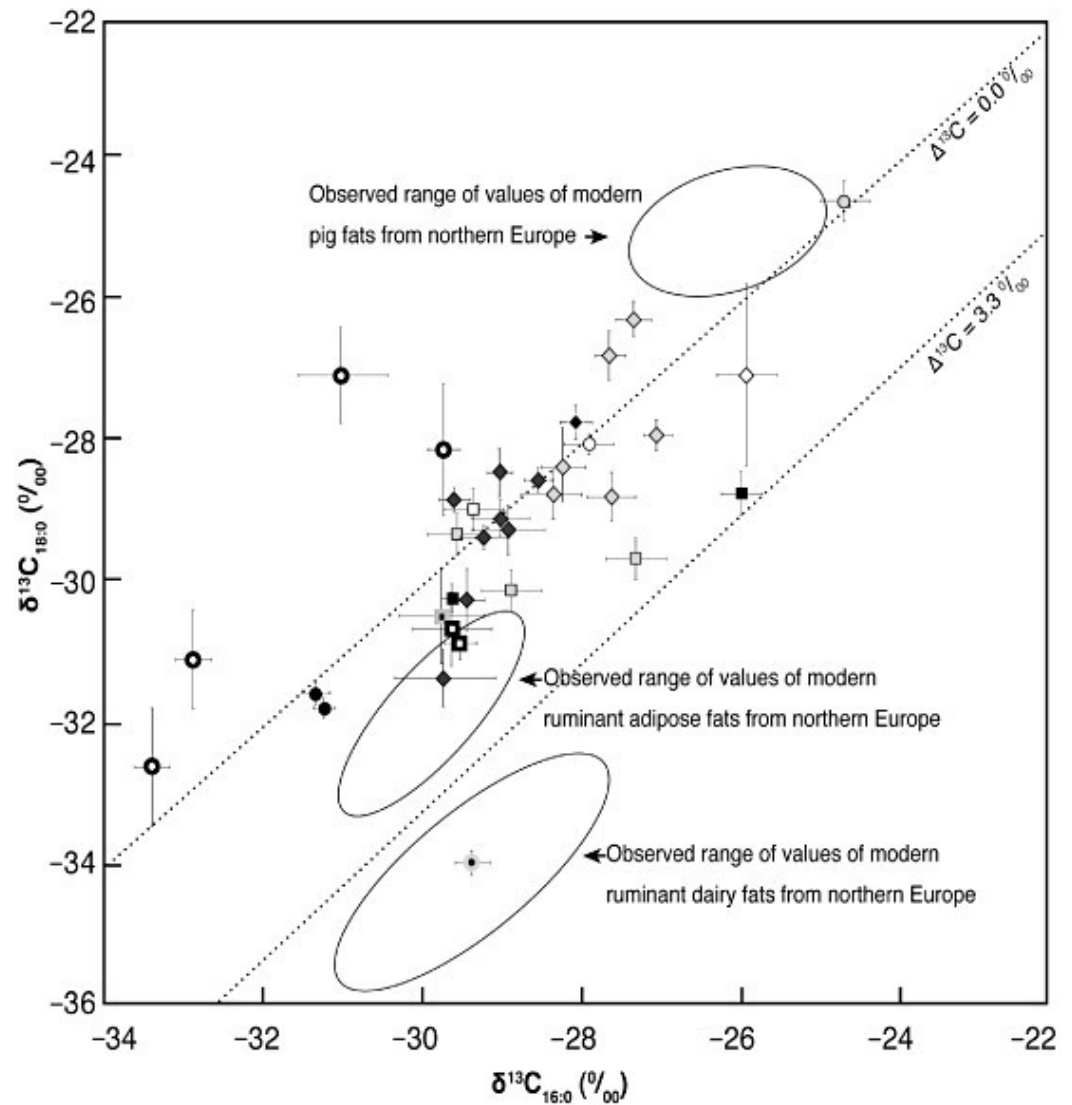
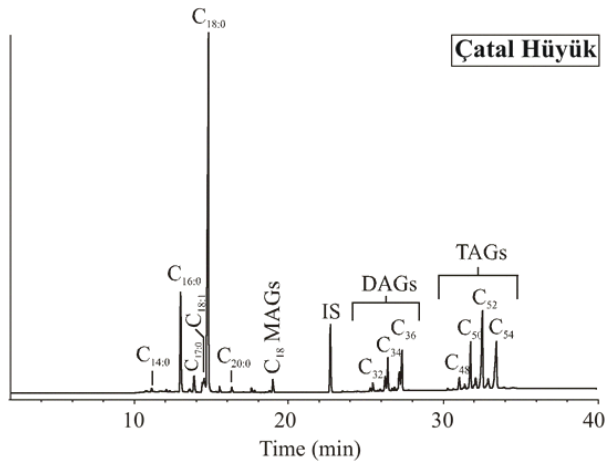


Indikace migrace na základě poměru izotopů síry ve vlasech

Keratin



Lipidy



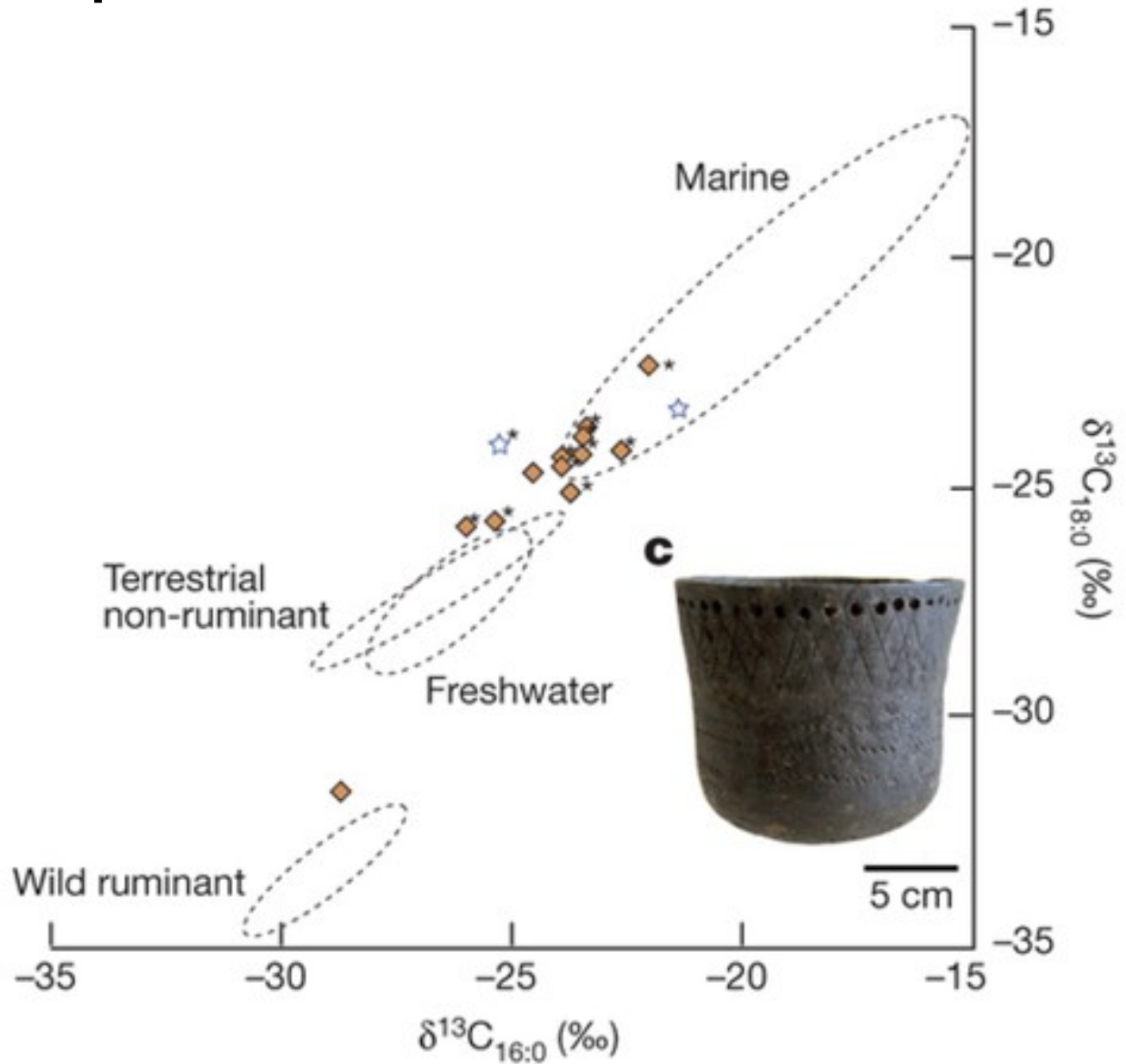
$\delta^{13}\text{C}$ values of potsherd extracts

- ◇ Abu Hureyra, Syria (6)
- ◇ Newe Yam, Israel (3)
- ◇ Çayonu, Turkey (1)
- ◇ Dalma Tepe, Iran (1)
- Hajji Firuz, Iran (2)
- ◆ Tepe Sarab, Iran (1)
- Ali Kosh, Iran (1)
- Toll-e Bashi, Iran (2)
- ◆ al-Basatin, Jordan (8)

$\delta^{13}\text{C}$ values of modern reference fats

- ◆ Sheep butter, Wadi Mujib, Jordan (1)
- Wild boar adipose, Wadi Qilt, Palestine (4)
- Goat adipose, Wadi Qilt, Palestine (2)
- Ethnographic pot, Kizilkaya, Turkey (1)
- Commercial sheep adipose, Israel (1)

Izotopy v lipidech



Mléko and mléčné produkty

Lipidy

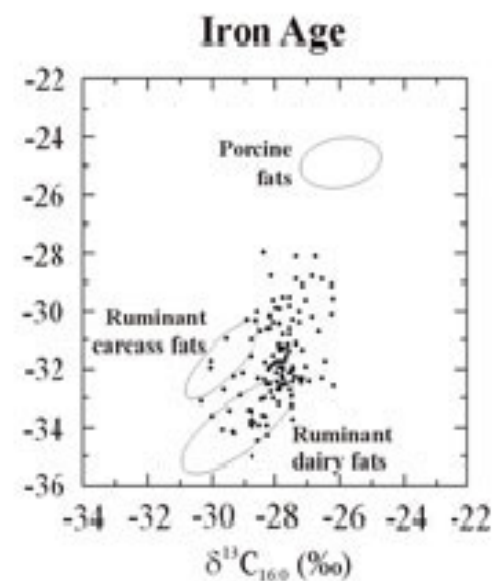
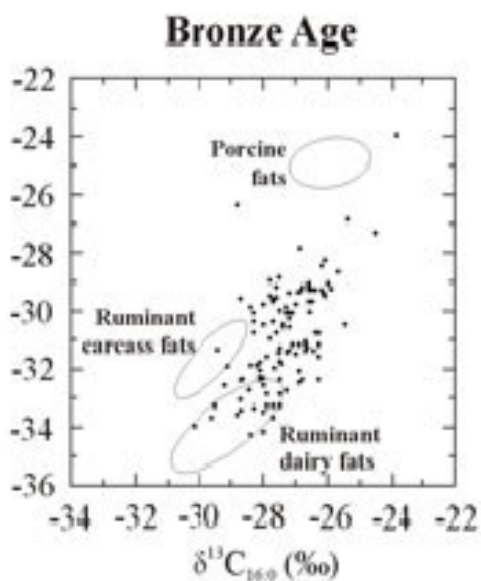
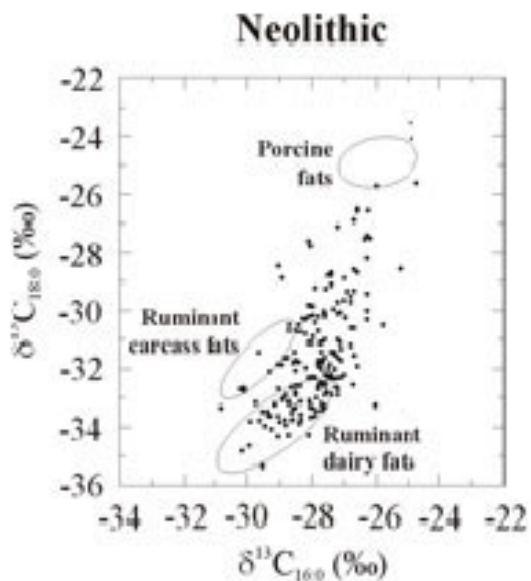
trans-mastné kyseliny (vyšší obsah v extrahovaném tuku)

Proteiny

kasein (termicky degradovaný) – druhově specifický

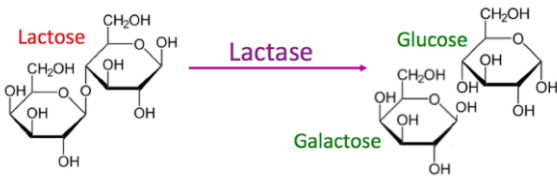


Keramika

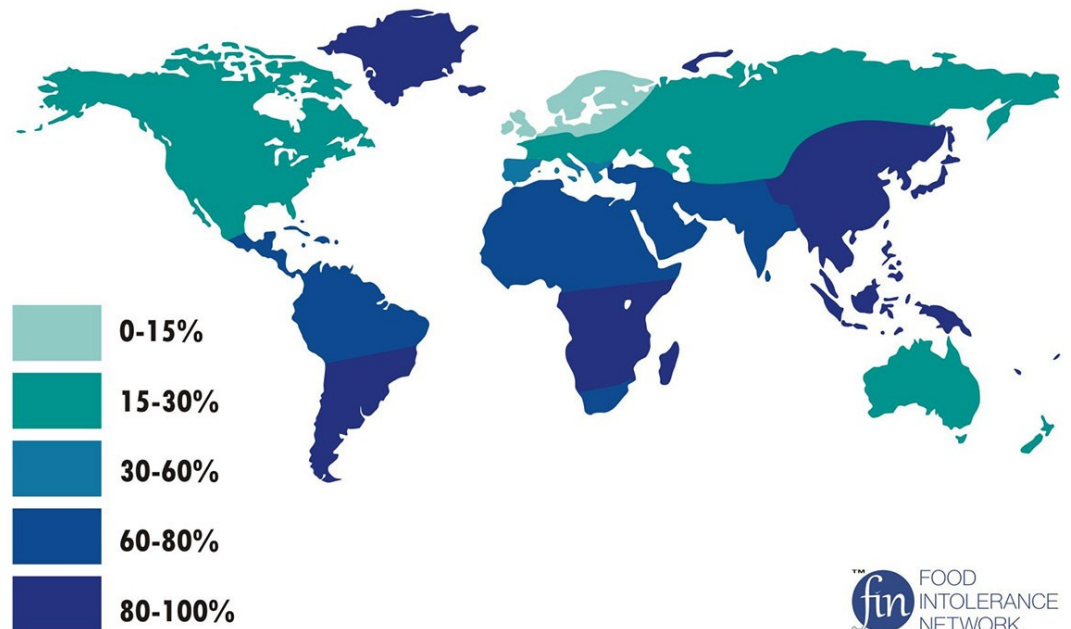
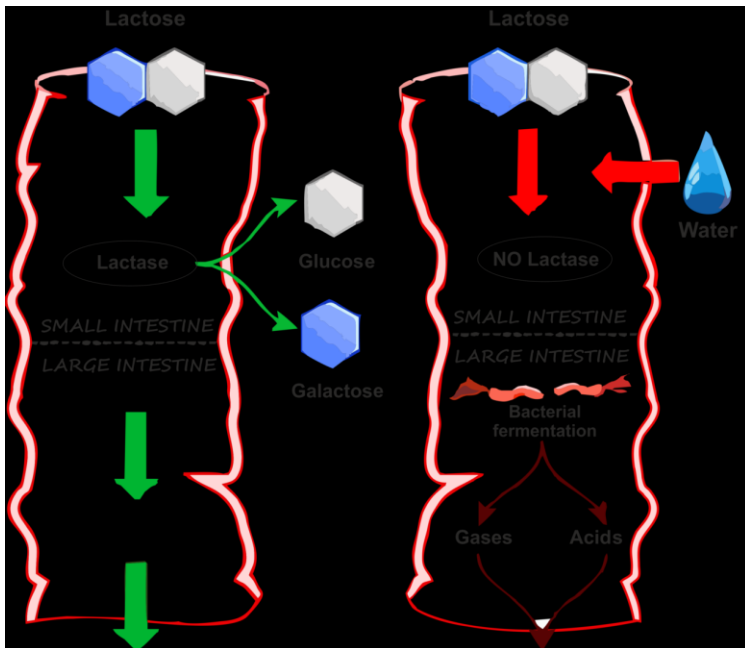


Intolerance laktózy

Intolerance laktózy je neschopnosť organizmu stráviť mliečny cukr. Je to prirodzený prvotný jav dospelého štádia ľudského života, pretože pôvodne sa mliekom živili iba kojenčatá. Kravské mlieko je pôvodom určené pre mláďatá kravy, ktorá túto intoleranciu nemávajú.



Worldwide prevalence of lactose intolerance in recent populations (schematic)

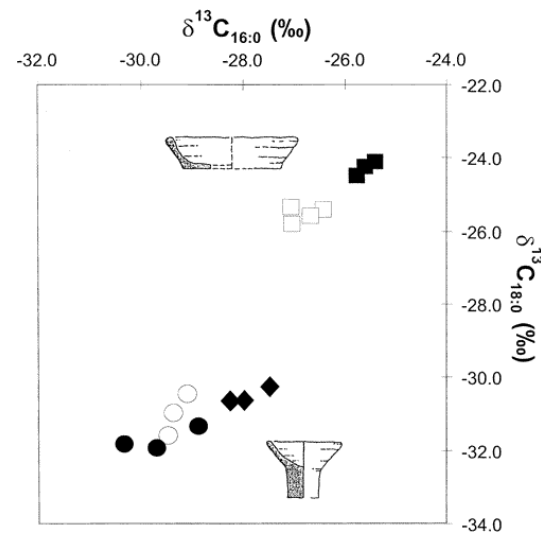


Maso

Keramika
Koprolity

Tuk (nespecifický)

Myoglobin (druhově specifický)



Midasova hrobka, Gordion

Na základě izotopů identifikováno umístění zcela rozložených pozůstatků nebožtíka.

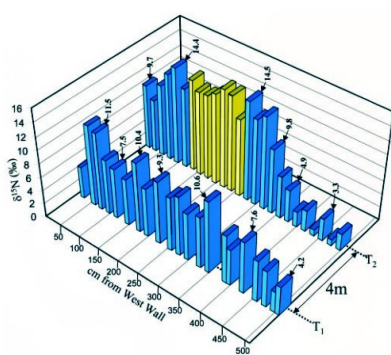


Fig. 3. Stable-N isotope analysis of transects T₁ and T₂ shown in perspective view. The yellow bars indicate position of the remains of the king within his coffin.

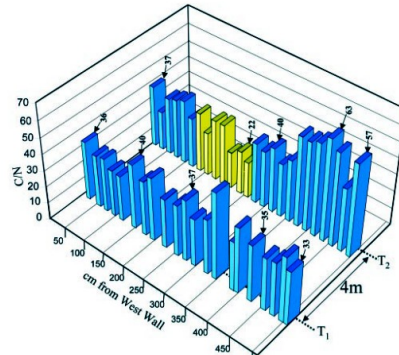


Fig. 4. Atomic C/N ratio of transects T₁ and T₂ are shown in perspective view. The yellow bars indicate position of the remains of the king within his coffin.

Table 1. Results from nitrogen elemental and stable isotope analysis of wooden artifacts from the MM tomb

Sample	Description	$\delta^{15}\text{N}$, %	C/N
A	Coffin support block interior: minimal degradation	-4.0	82.8
B	West ledge of coffin	13.6	12.2
C	Coffin under body remains	15.4	13.5
D	Coffin support block: significant degradation	14.2	17.4
E	Degraded table top 9	2.7	17.0
F	Degraded table top 5	2.5	18.8
G	Degraded table top 4	4.3	21.9
H	Degraded table top inlaid table	4.8	24.5
I	Degraded table top 7	16.2	14.8
J	Undegraded exterior SW wall	-1.7	113.1

Letter designations correspond to artifacts shown in Fig. 1.

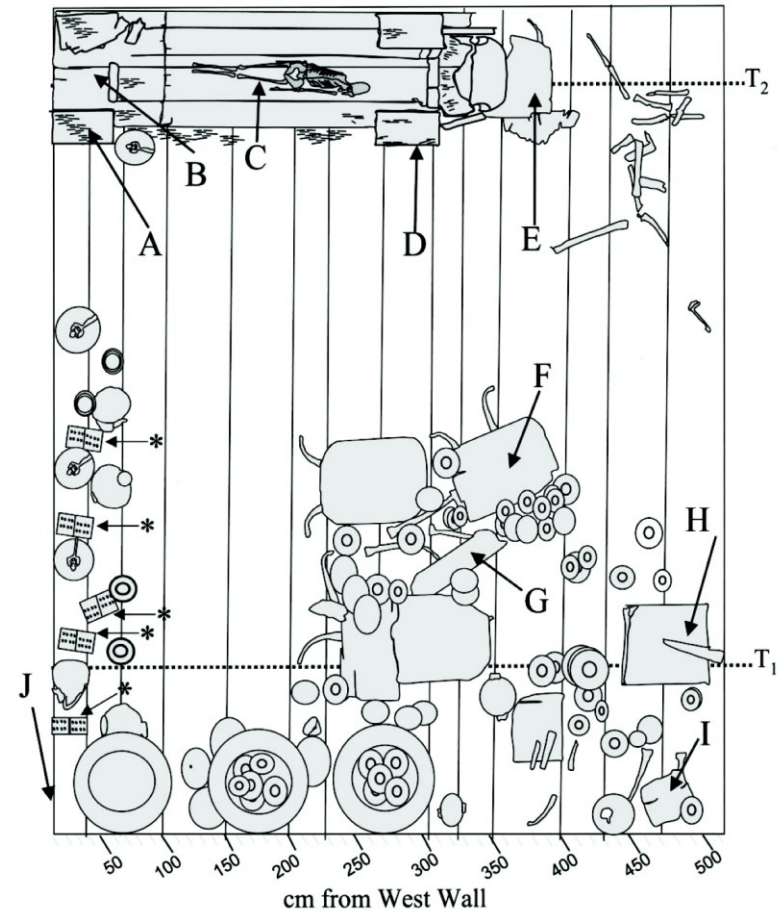
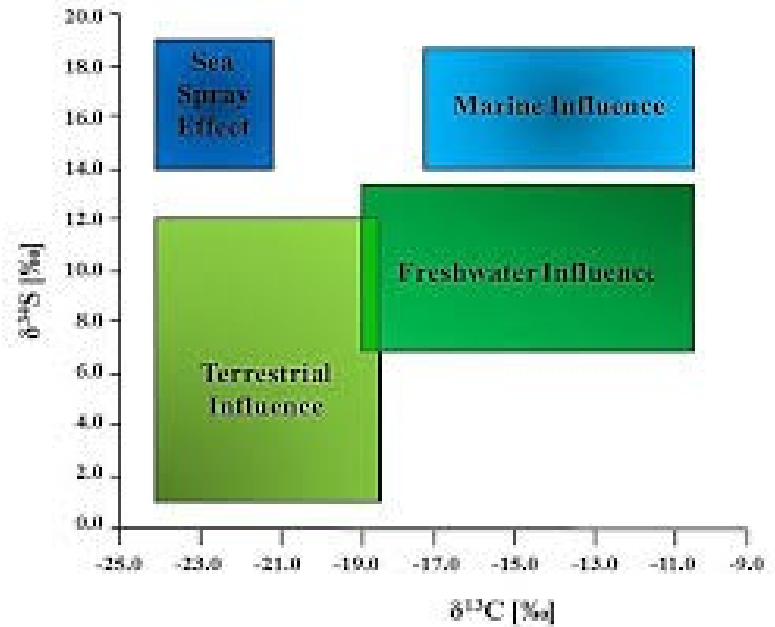
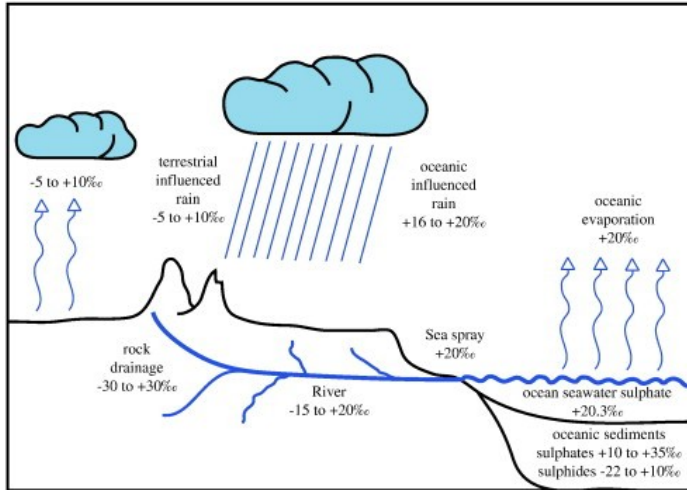


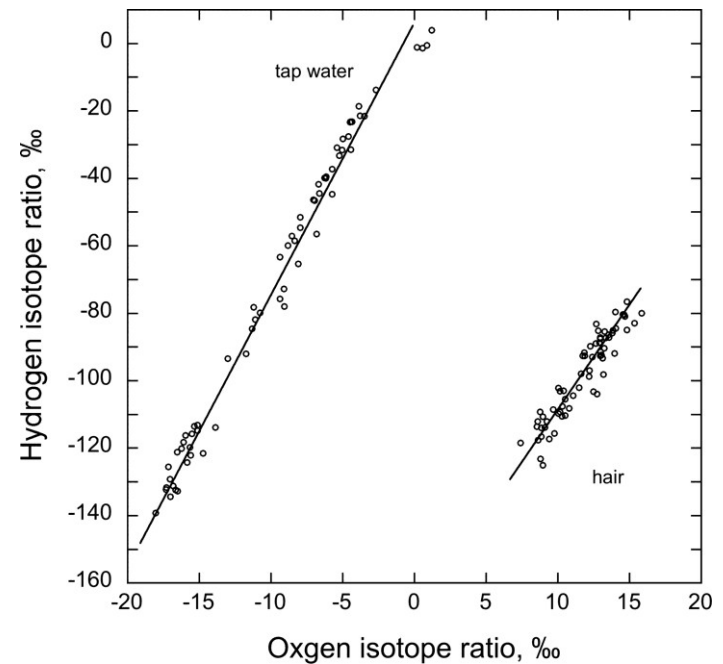
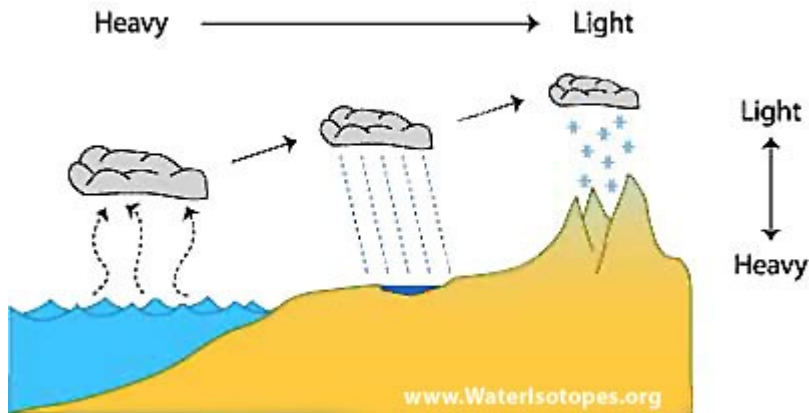
Fig. 2. Sketch plan of tomb with principal wooden and bronze artifacts drawn (redrawn from ref. 1). Letter designations correspond to items analyzed for their ¹⁵N content and atomic C/N ratio (see Table 1 for values). The transects T₁ and T₂ show regions from which floorboards were sampled for analyses after artifacts were removed from the tomb. Asterisks indicate the location of degraded leather belts.

Síra

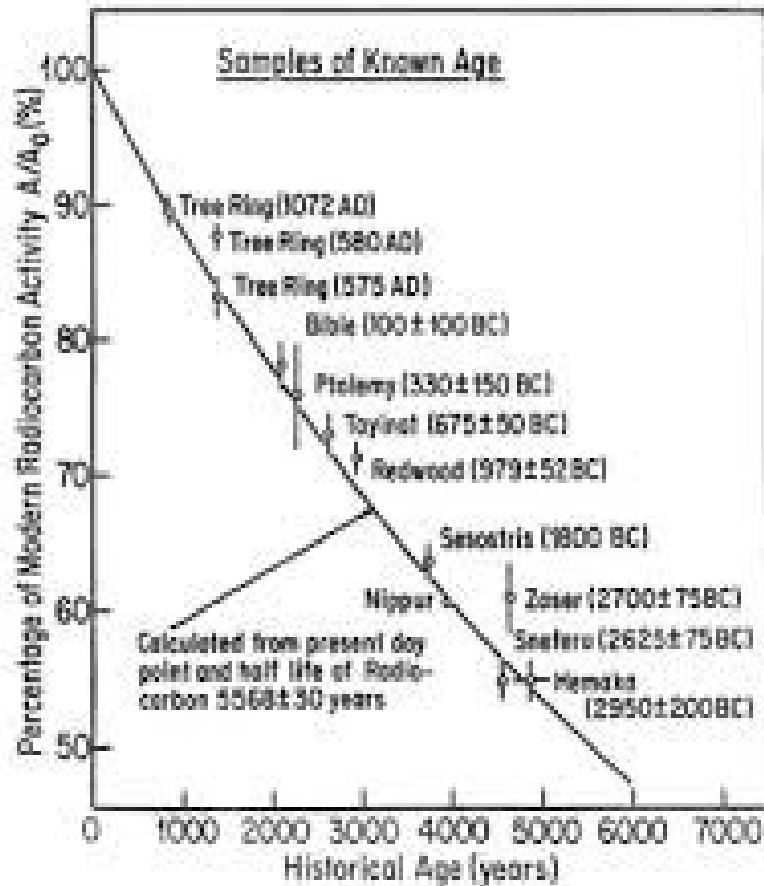


Kyslík a vodík

Partitioning of Isotopes in Vapor and Precipitation



Radiouhlíkové datování

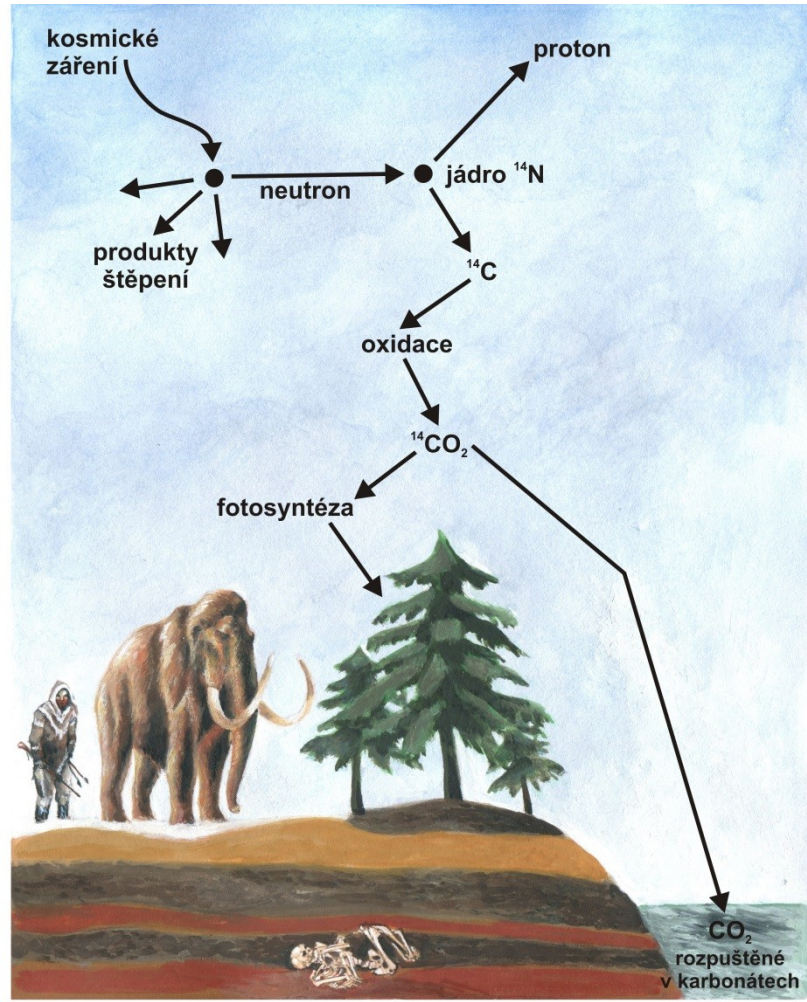


Willard Frank Libby

Alternativní chronologie: datování s využitím izotopu uhlíku ¹⁴C

Alternative chronology: dating utilizing carbon isotope ¹⁴C

PRODUKCE



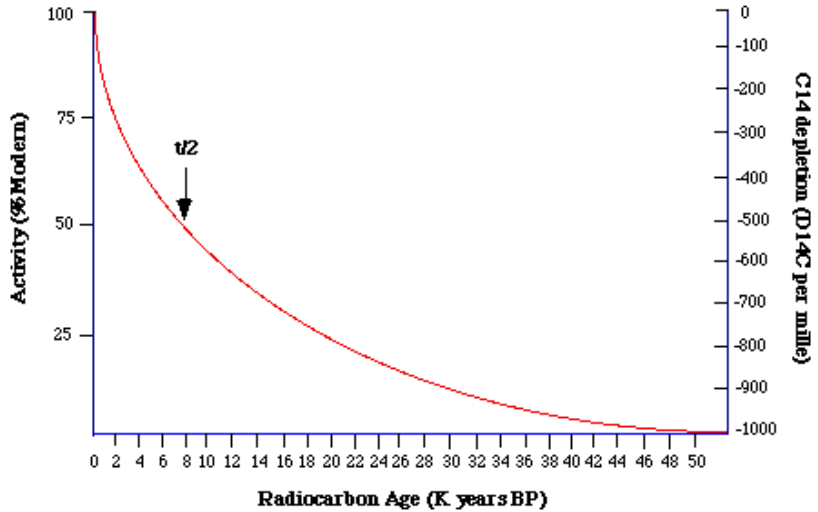
DISTRIBUCE

rovnovážná koncentrace: $\frac{^{14}\text{C}}{^{12}\text{C}} \approx 10^{-12}$
 rozpad: $^{14}\text{C} \rightarrow ^{14}\text{N} + e^- + \nu^-$
 poločas rozpadu: 5730 let
 1 gram \rightarrow ~10 rozpadů za minutu

ROZPAD

Fyzikální podstata:

Izotop ¹⁴C vzniká v horních vrstvách atmosféry;
 Odtud přechází do živých organismů a ukládá se v nich po dobu jejich života;
 Do flóry vlivem fotosyntézy, do fauny stravou;
 Po úmrtí organismu se v něm izotop ¹⁴C přestane ukládat a dochází k jeho pozvolnému rozpadu;

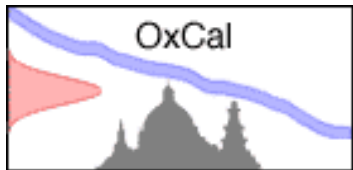
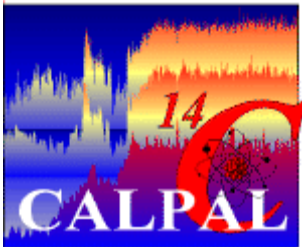


Výsledky měření a problematika kalibrace

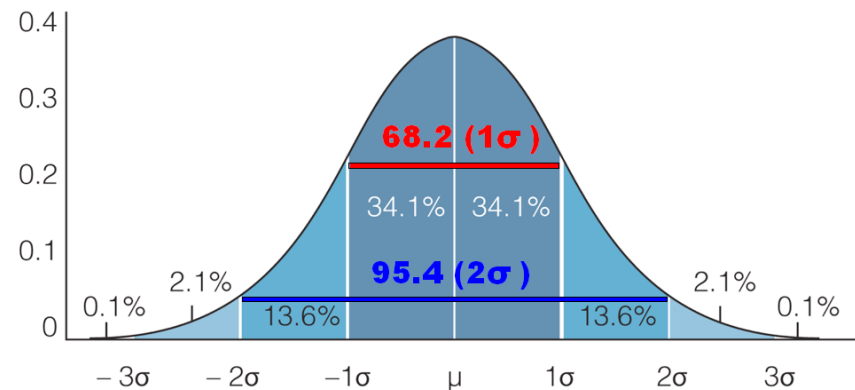
Results and calibration issue

Laboratorní výsledek je udáván ve formě **střední hodnota \pm směrodatná odchylka** (s předpokladem normálního rozdělení) v radiokarbonových letech (^{14}C BP nebo BC, vztažených k roku 1950);

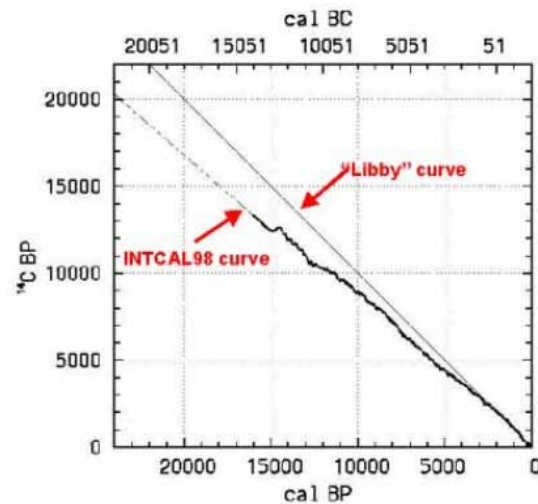
Jelikož radiokarbonové roky se liší od solárních let vlivem nehomogenní distribuce izotopu ^{14}C , je data třeba data kalibrovat. Používají se k tomu kalibrační softwary (CalPal, OxCal, Calib) a kalibrační sety (IntCal04, IntCal09). Pro období neolitu jsou základem kalibrace dendrodata. Výsledky jsou pak udávány v intervalech pravděpodobnosti 1σ (68,2 %) nebo 2σ (95,4 %).



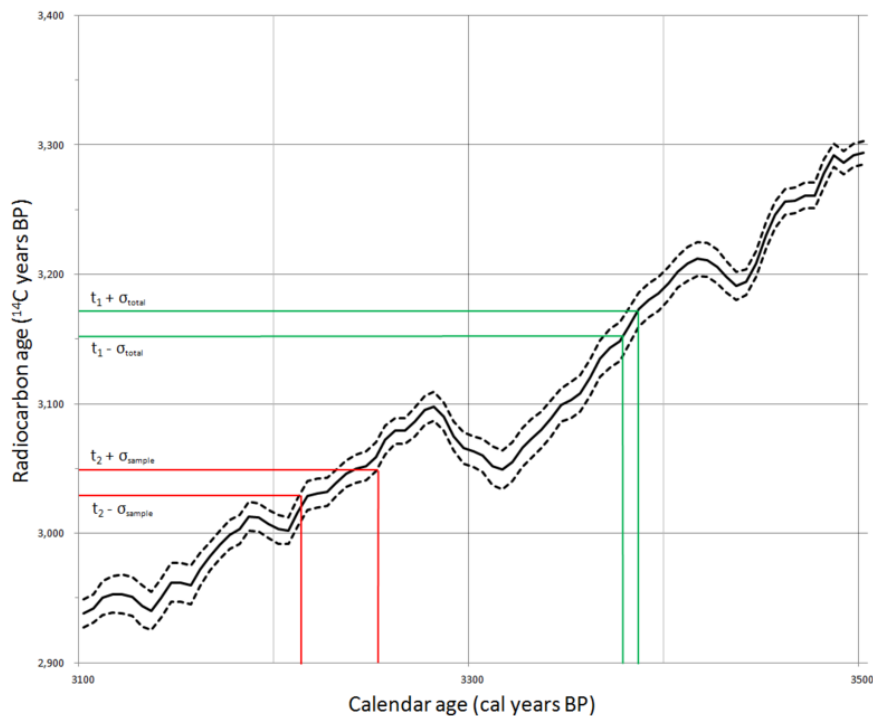
Gauss - Laplaceovo normální rozdělení
rozptyl pravděpodobnosti



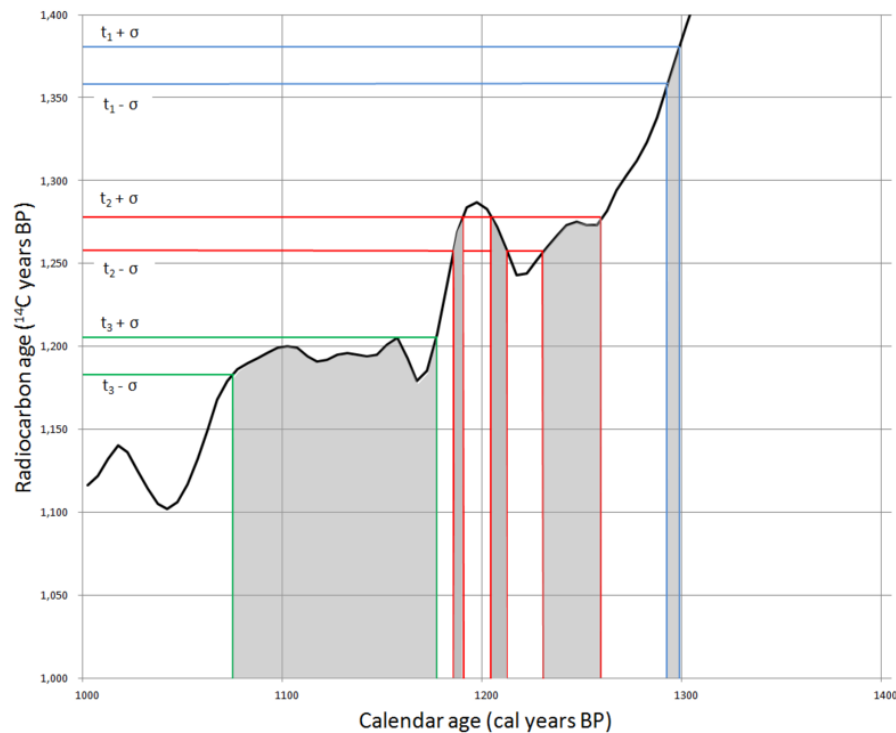
Kalibrace radiouhlíkových dat



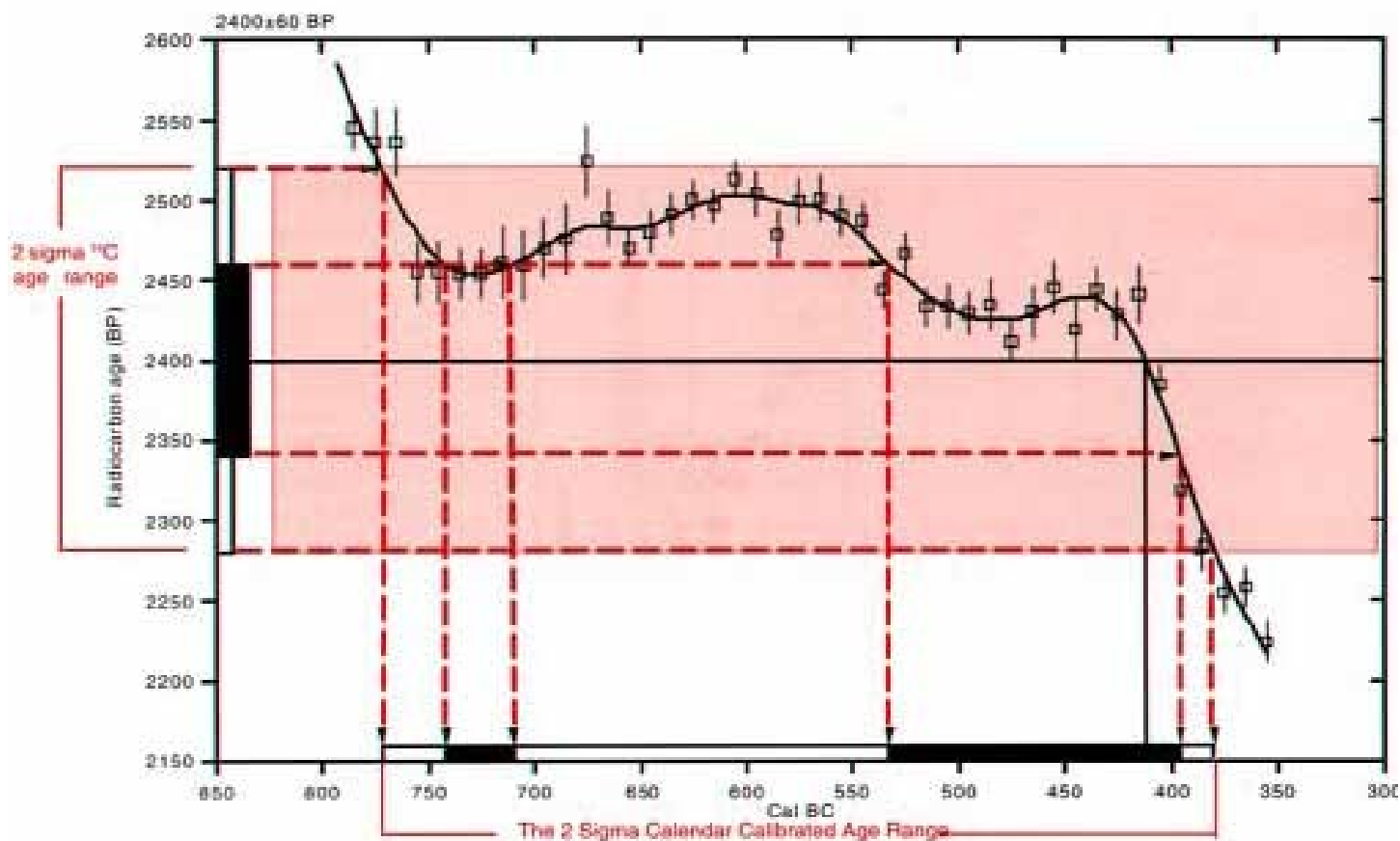
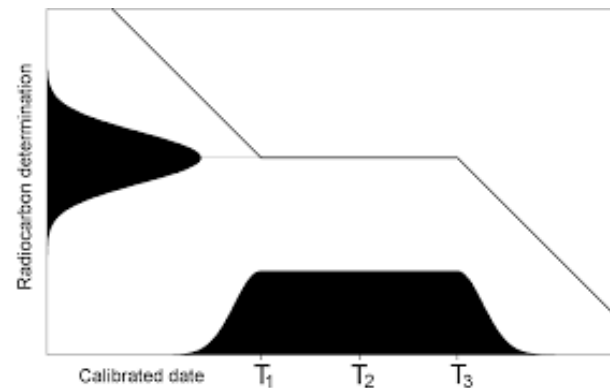
Calibration error and measurement error



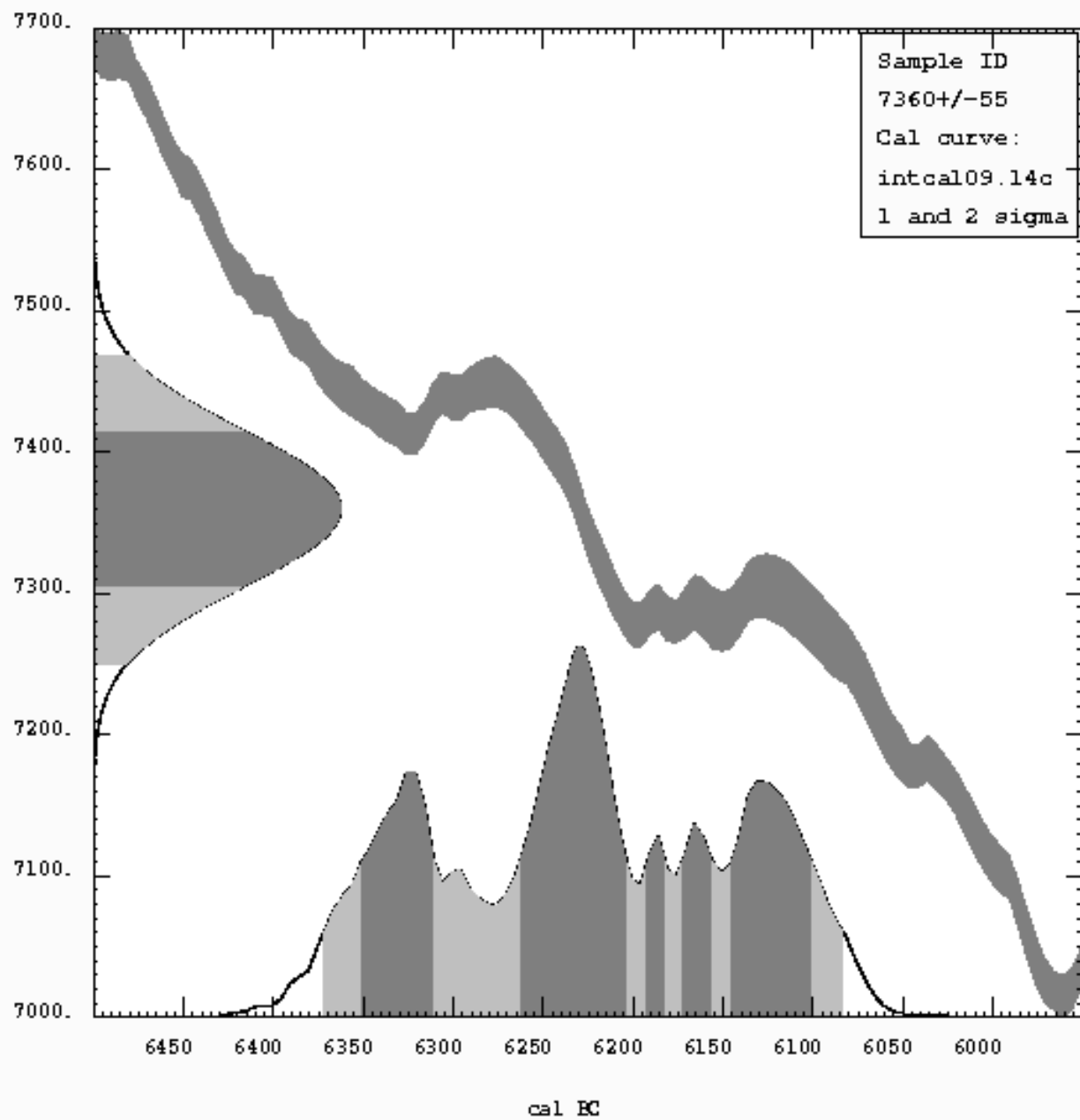
Variations in calibration results



Radiouhlíkové plató



Radiocarbon Age vs. Calibrated Age



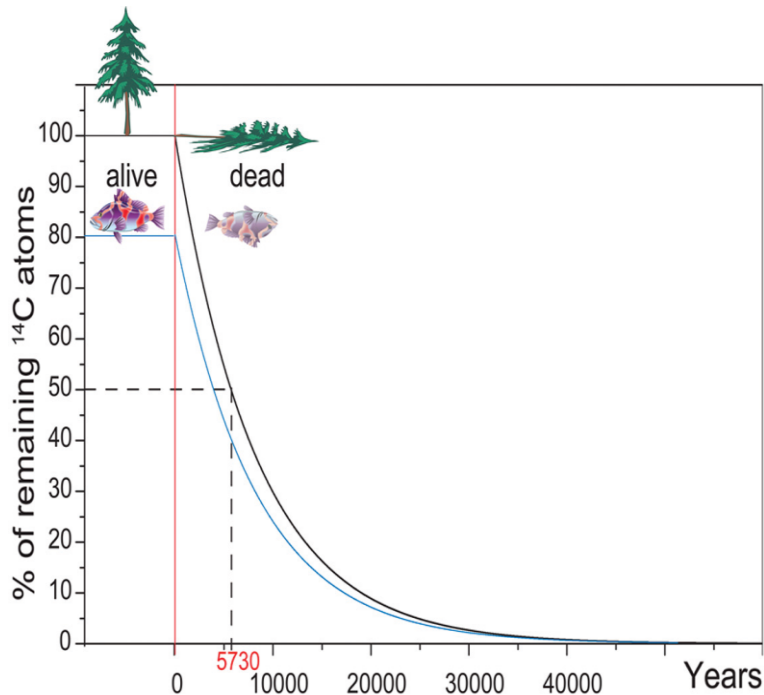
„Old wood“ problem

Materiál je mnohem starší než je doba jeho utilizace člověkem.

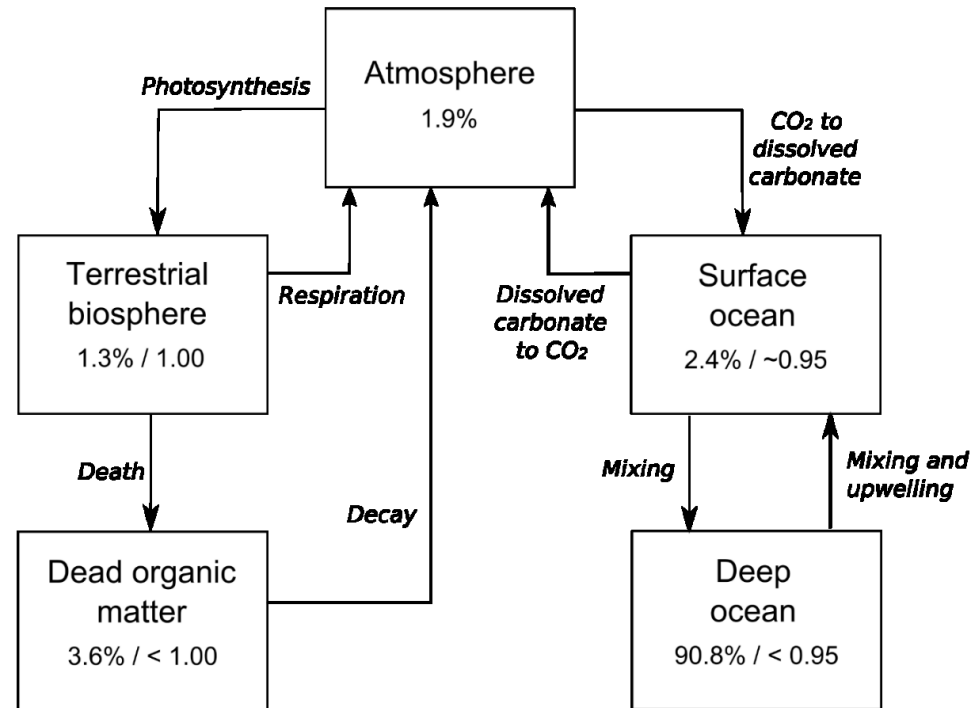


- dlouhověké dřeviny
- lidské pozůstatky
- lastury

Rezervoárový efekt



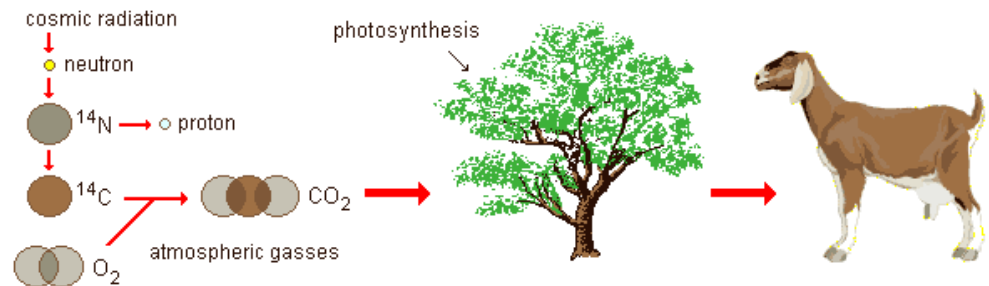
Carbon exchange reservoirs (simplified)

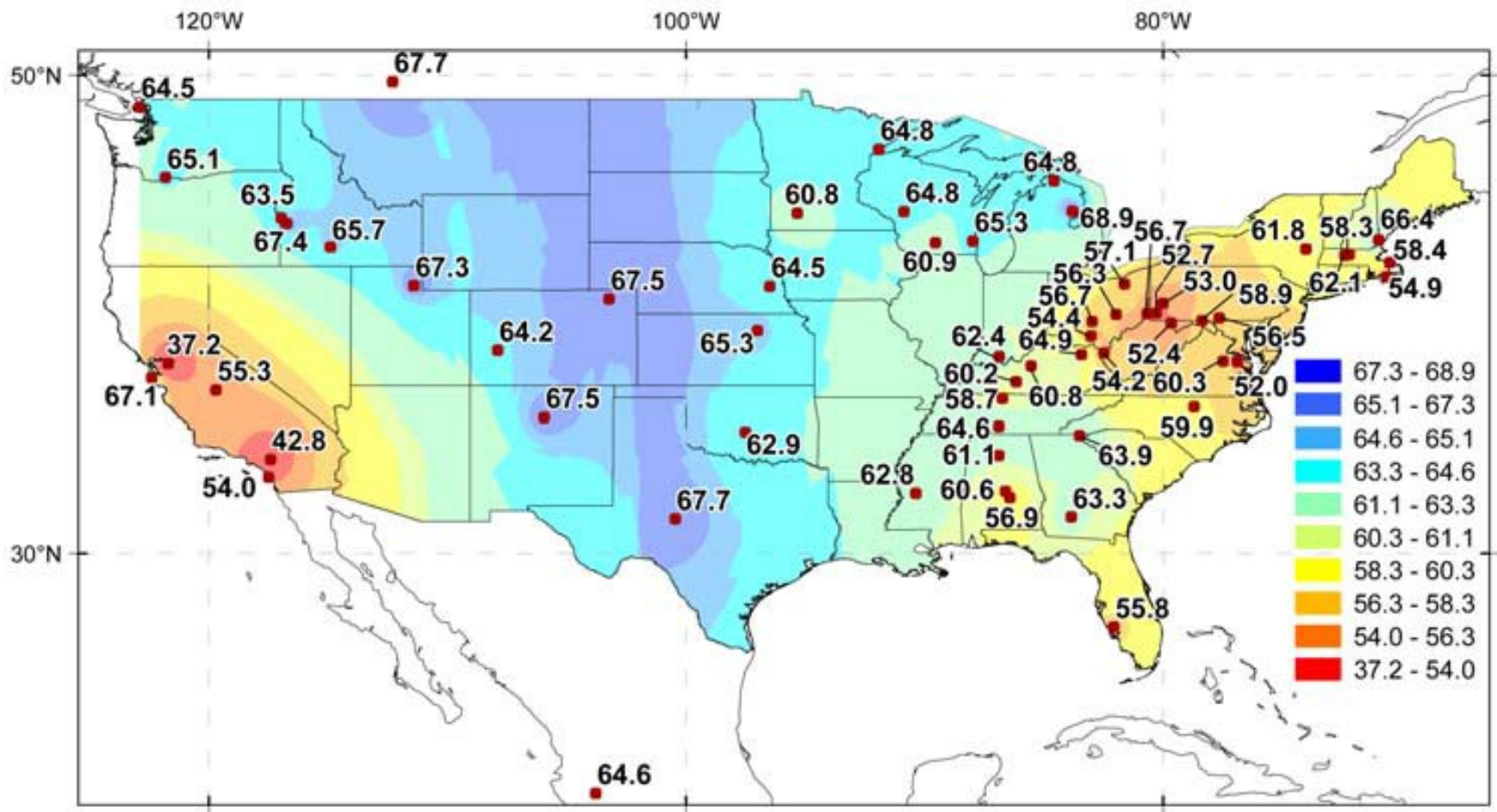


Percentages show the fraction of the total carbon reservoir of each type. Numbers after slash show ratio of ^{14}C to ^{12}C as fraction of atmospheric ratio.

Fosilní paliva

Fosilní paliva neobsahují žádný radiouhlík, exhalacemi CO₂ z jejich spalování dochází ke snižování relativního zastoupení radiouhlíku v atmosféře a vegetaci.

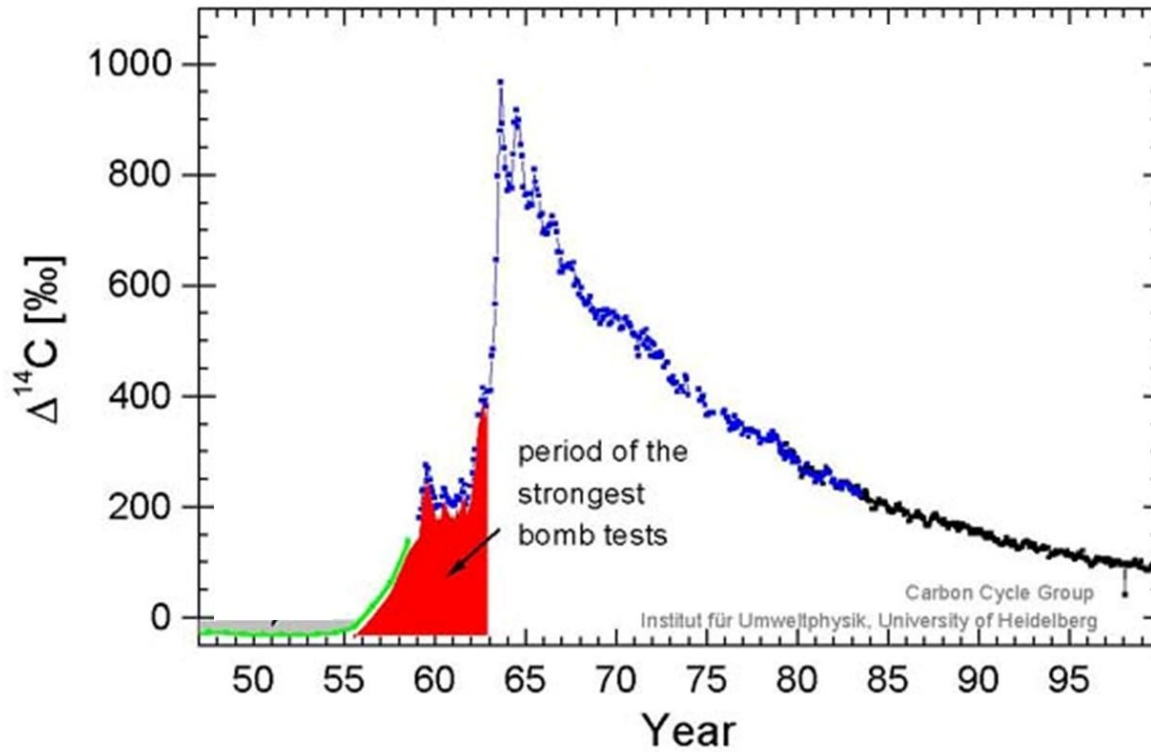




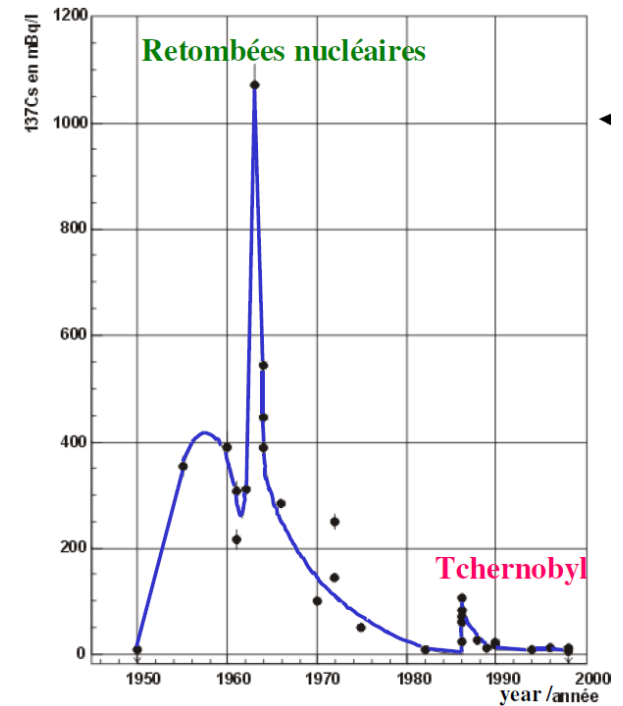
D14C measurements of corn (*Zea mays*) across North America during the summer of 2000. During this period, a decrease of 2.8% corresponded to approximately 1 ppm of added fossil fuel carbon.

Bomb peak (bomb spike)

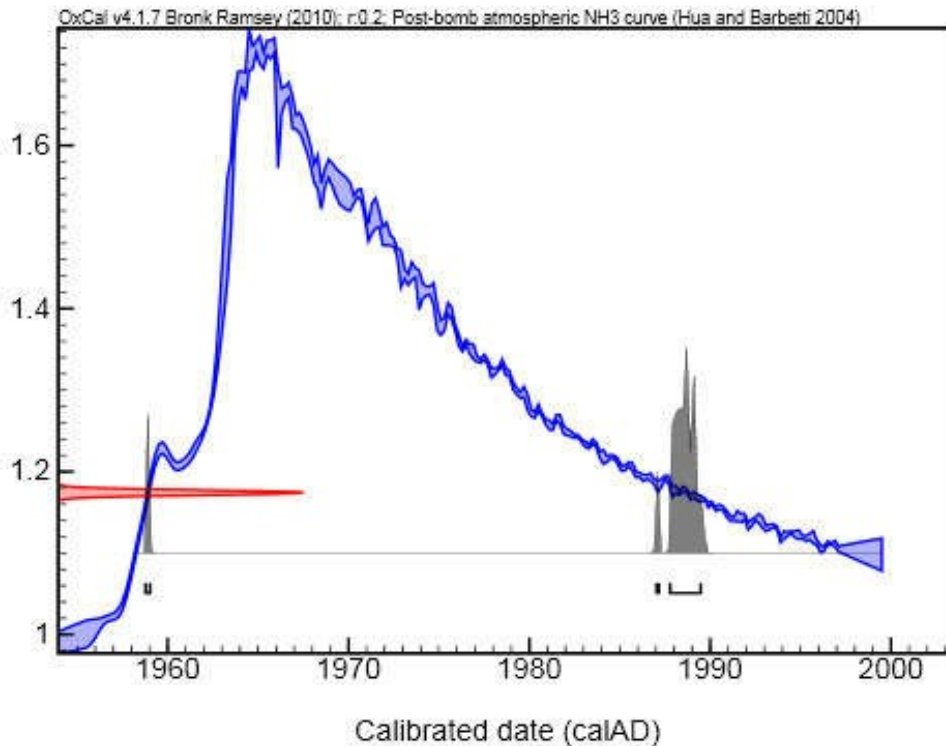
^{14}C in atmospheric CO_2



^{137}Cs



Bomb peak (Bomb spike)



Geschlecht	Alter in Jahren ^a	% C-14 über dem Rezentwert		Quotient $\text{Co}_3^{2-}/\text{Kollagen}$
		im CO_3^{2-}	im Kollagen	
w	20	$40,5 \pm 1,2$	$31,8 \pm 0,6$	1,3
gleiche Pers.	20	$39,5 \pm 1,2$	$26,8 \pm 0,6$	1,5
andere Probe	30	—	$17,3 \pm 0,6$	—
m	61	$22,6 \pm 1,3$	$11,8 \pm 0,5$	1,9
m	65	$21,0 \pm 0,7$	$6,6 \pm 0,4$	3,2
w	65	$27,6 \pm 1,7$	$15,3 \pm 0,6$	1,8
w	65	$31,0 \pm 1,6$	$18,4 \pm 0,6$	1,7
m	69	$27,1 \pm 0,9$	$10,7 \pm 0,4$	2,5
w	70	$28,6 \pm 0,8$	$14,2 \pm 0,6$	2,0
w	75	$29,4 \pm 2,0$	$23,6 \pm 0,4$	1,2
m	79	$19,0 \pm 1,0$	$8,0 \pm 0,6$	2,4
Mittelwert f. Alter	60—80 ^a	$25,6 \pm 1,7$	$13,6 \pm 2,0$	$2,1 \pm 0,2$

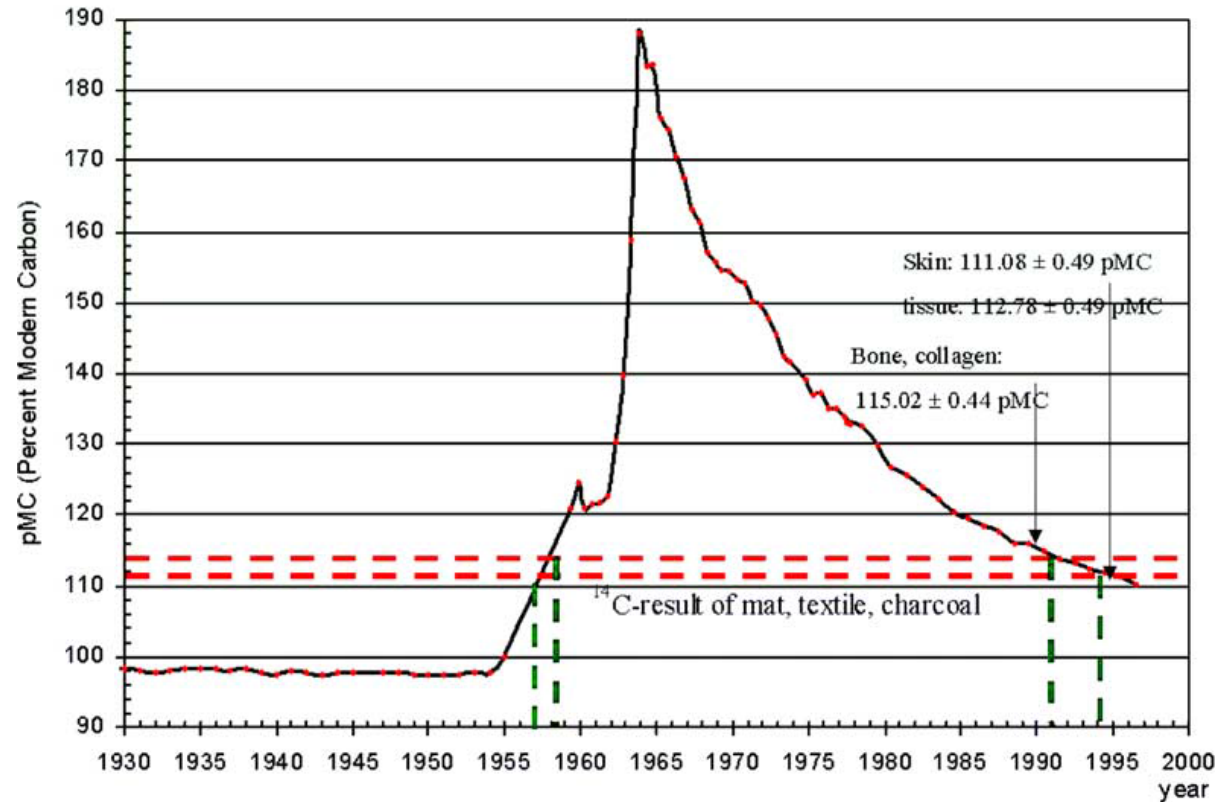
^a Beim Tod im September bis Oktober 1967.

Perská mumie



Konfiskována 2000 na černém trhu, podle nápisů by se mělo jednat o Ruduunu, dceru krále Xerxa (518-465 BC).

^{14}C bomb peak



Jedinec zemřel AD 1994–1996, mumie je podvrh.

Table 1 Summary of the selected samples.

Sample ID	Sample	Analyzed fraction
S1	Head hair	Hair keratin
S2	Mandibular right canine	Dental enamel
S3	Mandibular right second molar	Dental enamel
S4	Pubic symphysis	Trabecular bone
S5	Base of skull	Cortical bone

Male, 36 y
1973-2010

Table 2 Results of AMS ^{14}C dating analyses.

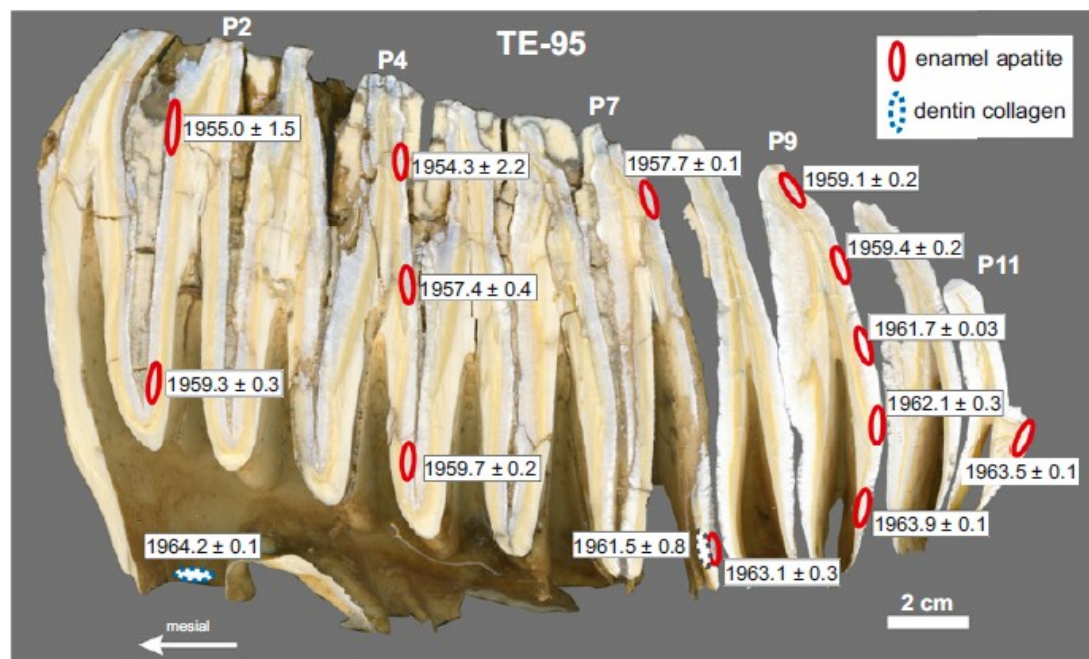
Sample ID	Fraction modern ($\pm 1\sigma$)	Calibrated ages (1σ ranges)	Dates yr AD (1σ)
S1	1.0493 ± 0.0056	2007–2011	2009.0 ± 2.0
S2	1.3632 ± 0.0079	1975.4 (May)–1976.7 (Sep)	1976.0 ± 0.7
S3	1.3182 ± 0.0063	1977.9 (Nov)–1979.3 (Apr)	1978.6 ± 0.7
S4	1.0674 ± 0.0044	2003 (Jan)–2006.7 (Sep)	2004.9 ± 1.9
S5	1.1463 ± 0.0044	1990.5 (Jun)–1992.8 (Oct)	1991.6 ± 1.1

Summary of the first radiocarbon results from collagen fractions extracted from human bone (30-year old man, deceased in 1995) with the soft chemical method displayed in Fig. 2

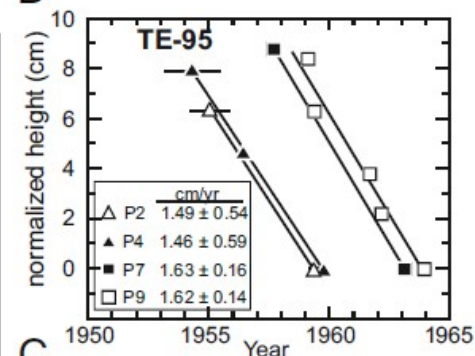
Sample name	Sample preparation method	$\delta^{13}\text{C}^{\text{a}}$ (‰)	^{14}C content ^a (pMC)	Calibrated age ^b (AD)
A	Collagen (insoluble fraction after EDTA treatment of bone powder)	-22.3 ± 0.7	126.2 ± 1.0	1958–1962 (0.23) 1980–1983 (0.77)
B	Insoluble collagen after pepsin digestion of sample A	$-22.8 \pm 0.7^{\text{c}}$	$123.3 \pm 0.6^{\text{c}}$	1958–1961 (0.51) 1982–1984 (0.49)
C	Soluble collagen fraction after pepsin digestion of sample A	-22.2 ± 1.5	125.1 ± 1.1	1958–1962 (0.36) 1980–1984 (0.64)
D	Collagen (method used in radiocarbon dating for the production of gelatin)	-16.1 ± 3.8	141.12 ± 1.20	1962 (0.04) 1973–1975 (0.96)
E	Long bone, lipid fraction	-22.0 ± 0.9	113.73 ± 0.55	1957–1958 (0.07) 1990–1994 (0.93)

	Raw ^{14}C data		Calibrated results (calendar year)				Police Invest.
	Lens	Nail	Lens	Nail	Span	Combined	
Baby #1	1.054(5)	1.078(4)	2006	2000–2004	2000	2003–2007	2004
Baby #2	1.165(5)	1.186(4)	1988–1990	1985–1988	1985–1990	1986–1988	1988
Baby #3	1.185(4)	1.194(4)	1986–1988	1985–1987	1985–1989	1985–1987	n.d.

A



B



C

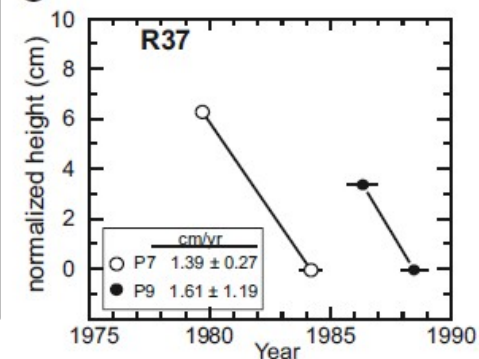
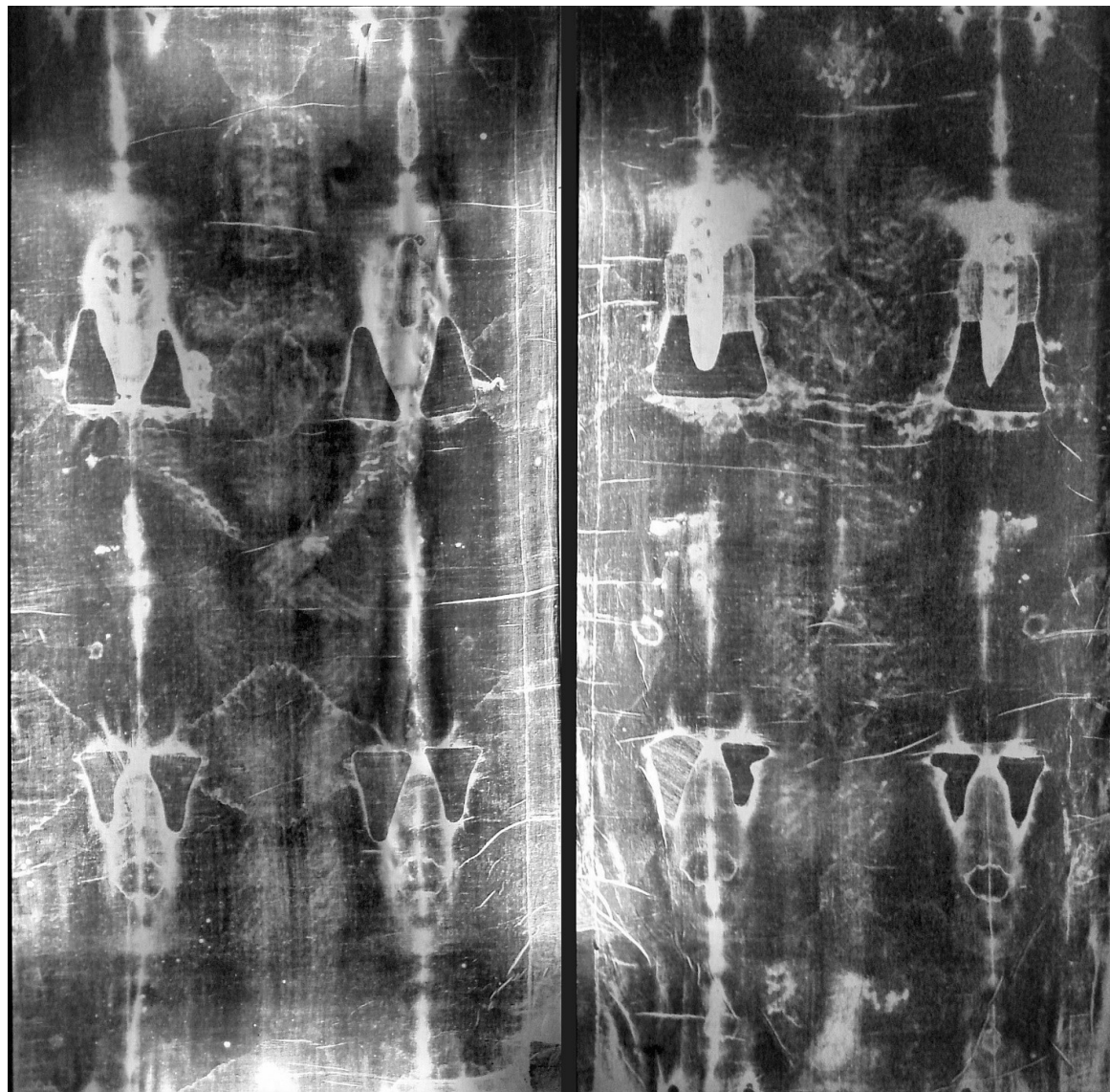


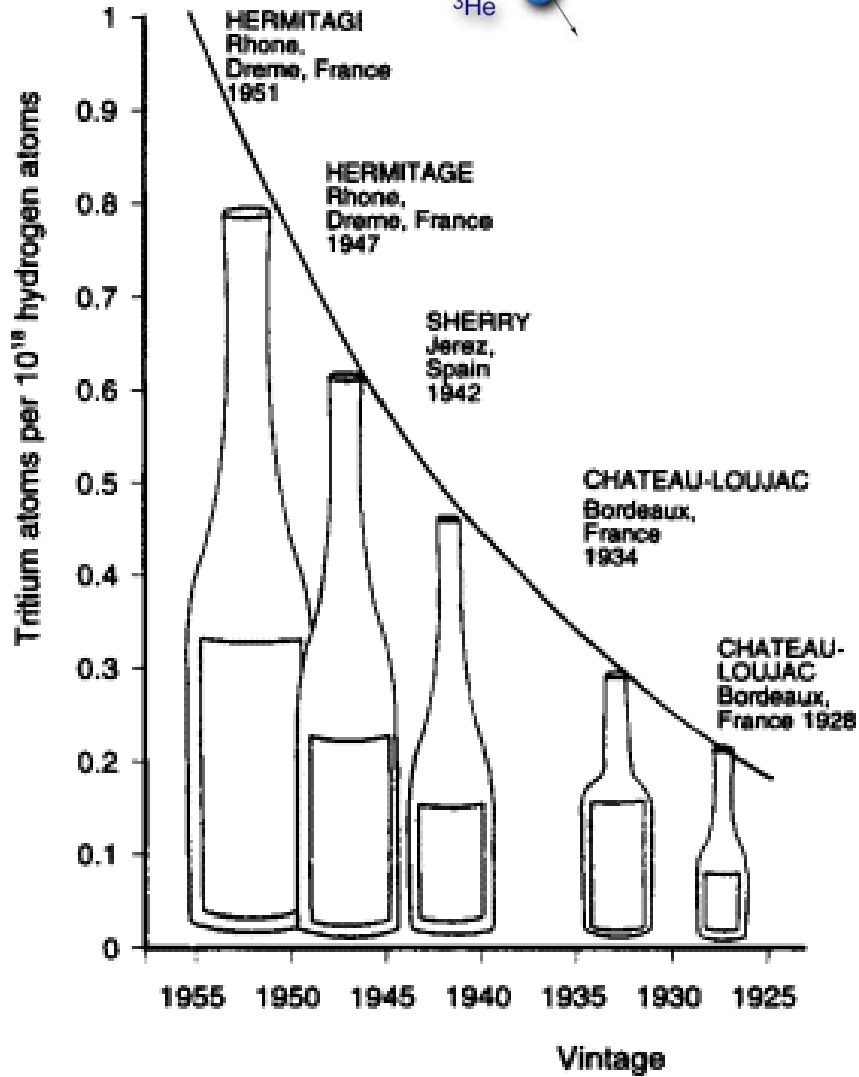
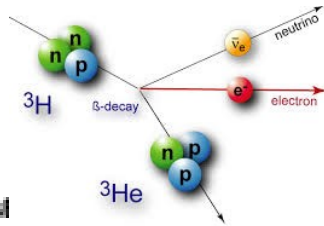
Fig. 3. (A) Longitudinally cut elephant molar (m3) from individual TE-95 showing calibrated ^{14}C ages ($\pm 2\sigma$) for 13 enamel apatite and 2 dentin collagen samples. Sample locations are outlined as ellipses. The molar consists of 11 enamel-covered plates (P1 to P11). (B) Vertical growth rates from four TE-95 molar plates shown in A are calculated from ^{14}C ages. (C) Vertical growth rates in two molar plates from a lower third molar belonging to R37 (see text). Growth rates ($\pm 2\sigma$) are calculated from slopes; height along a plate is normalized to the lowest sample location. Age uncertainty is 2σ and if not shown is smaller than the symbol.

Turínské plátno

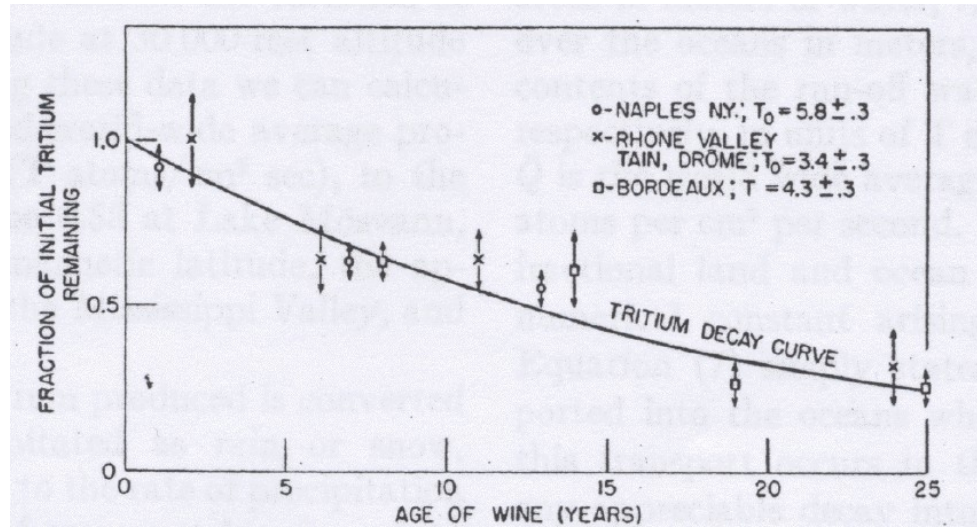
Datování pomocí
radiouhlíku
problematické



Tritium



Datování vína a koňaku.



Poločas rozpadu $T_{1/2} = 12.46$ roku