

Time-Resolved Fluorescence

Fluorescence methods in life sciences

Ctirad Hofr

Overview

- Definition of Time-Resolved (TR) fluorescence
- Types of TR fluorescence measurement
- Practical applications of TR fluorescence

Steady-state and Time-resolved fluorescence

- **Time-resolved fluorescence** is measured using excitation pulse (pulse length is usually shorter than the fluorescence decay of the sample) or phase-modulated excitation light and enables to analyze the time dependence of the measured parameters.
- **Steady-state fluorescence** is measured at excitation by continuous radiation and then we get a time average value of intensity or fluorescence polarization.

Why to measure time-resolved fluorescence?

- Describes about the decrease in fluorescence intensity in time
- Measurement is relative, does not depend on actual intensity value
- Depends on the characteristics of surroundings
- Informs about dynamics – rotation of molecules

How long the fluorescence lasts?

Random decay to the ground state:
each molecule emits 1 photon

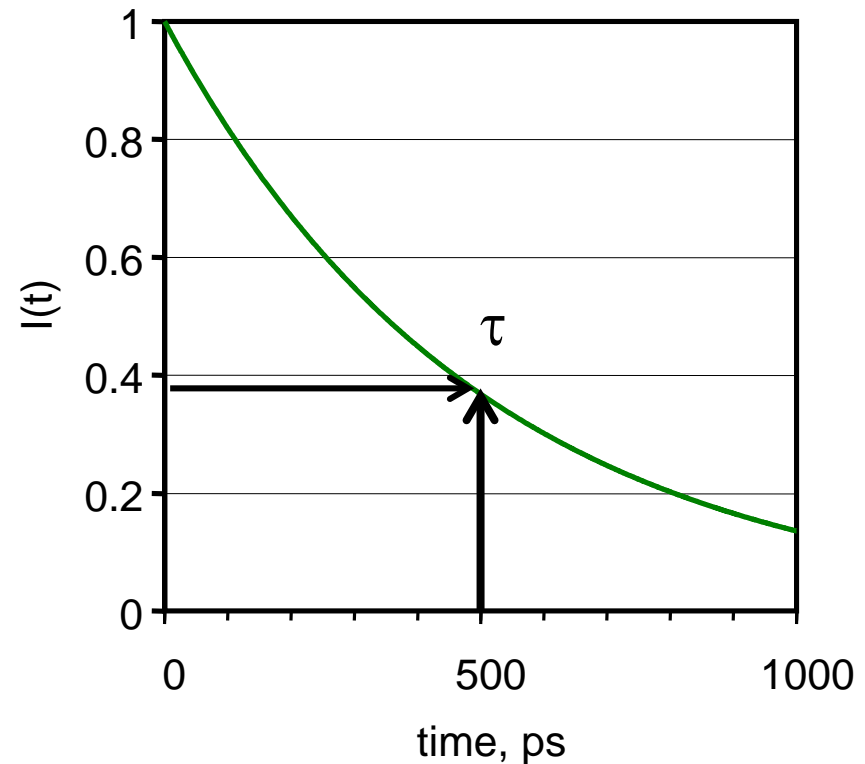
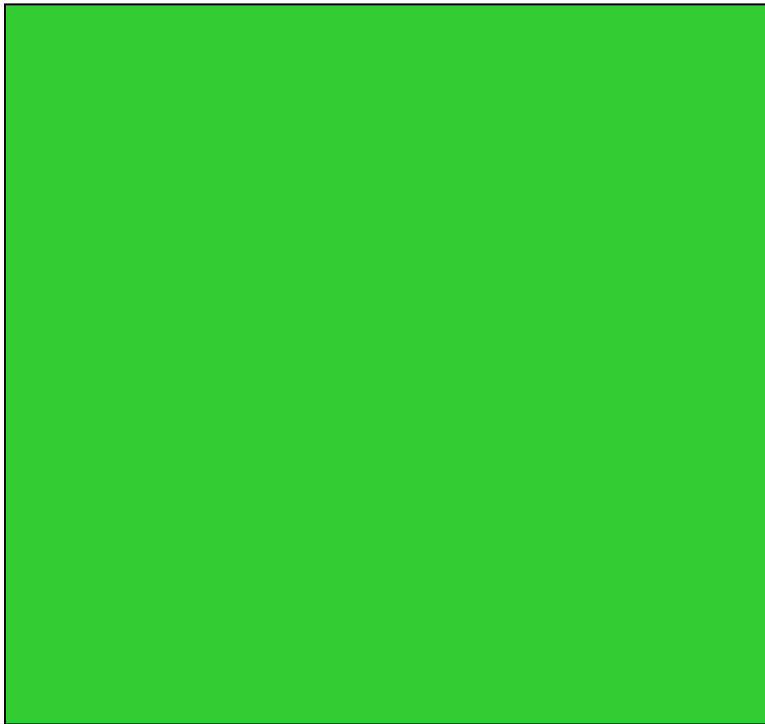

The population of the excited molecules by flash (pulse)

Time course of fluorescence

- The simplest is the exponential decline for spherical particles

$$I_{(t)} = I_0 e^{-t/\tau}$$

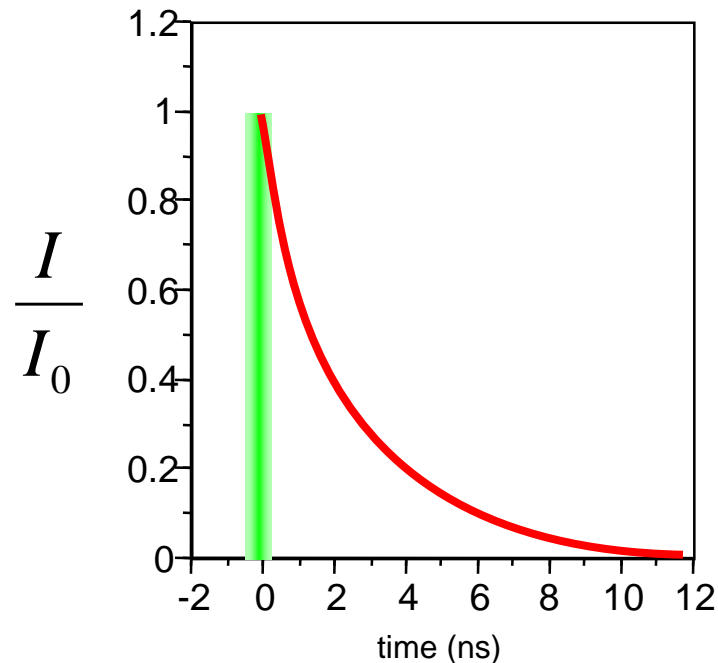

Fluorescence lifetime τ

- τ is mean time between excitation of the molecule (i.e. absorption of a photon) and emission of the light when returning molecules to the ground state

What is the fluorescence intensity in time τ after photon absorption?

$$I_{(t)} = I_0 e^{-t/\tau}$$

Lifetime $\tau = 2$ ns, then in this time $t = \tau$ fluorescence is 37% of the original intensity in time 0

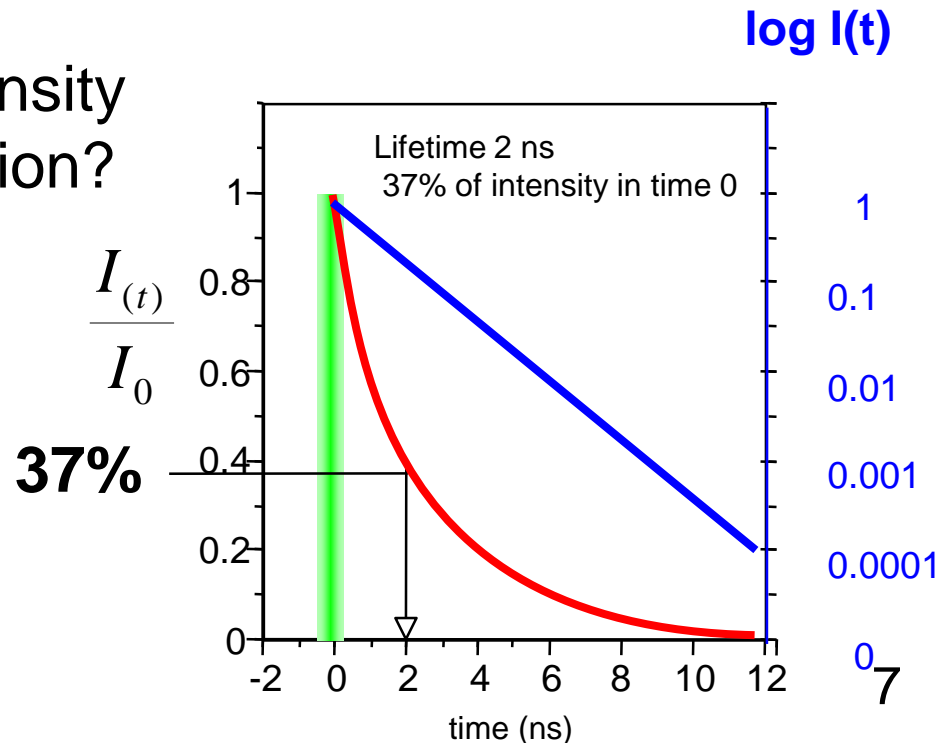

Why to measure fluorescence lifetime τ ?

- Absolute measurement – lifetime does not depend on the concentration of the sample
- The lifetime is dependent on the surrounding environment and can be used to determine its polarity, pH, temperature, ion concentrations, presence of quenchers
- Adds another dimension in fluorescence mapping - increases its selectivity
- Enables to measure rotational correlation time of molecules - rotational mobility

The main ways of measuring time-dependence of fluorescence

- **Pulse method (time-domain)** - source of excitation radiation is a short pulse
- **The method of phase-modulated excitation radiation (frequency domain)**
 - source of excitation radiation is sinusoidally modulated light

Pulse method

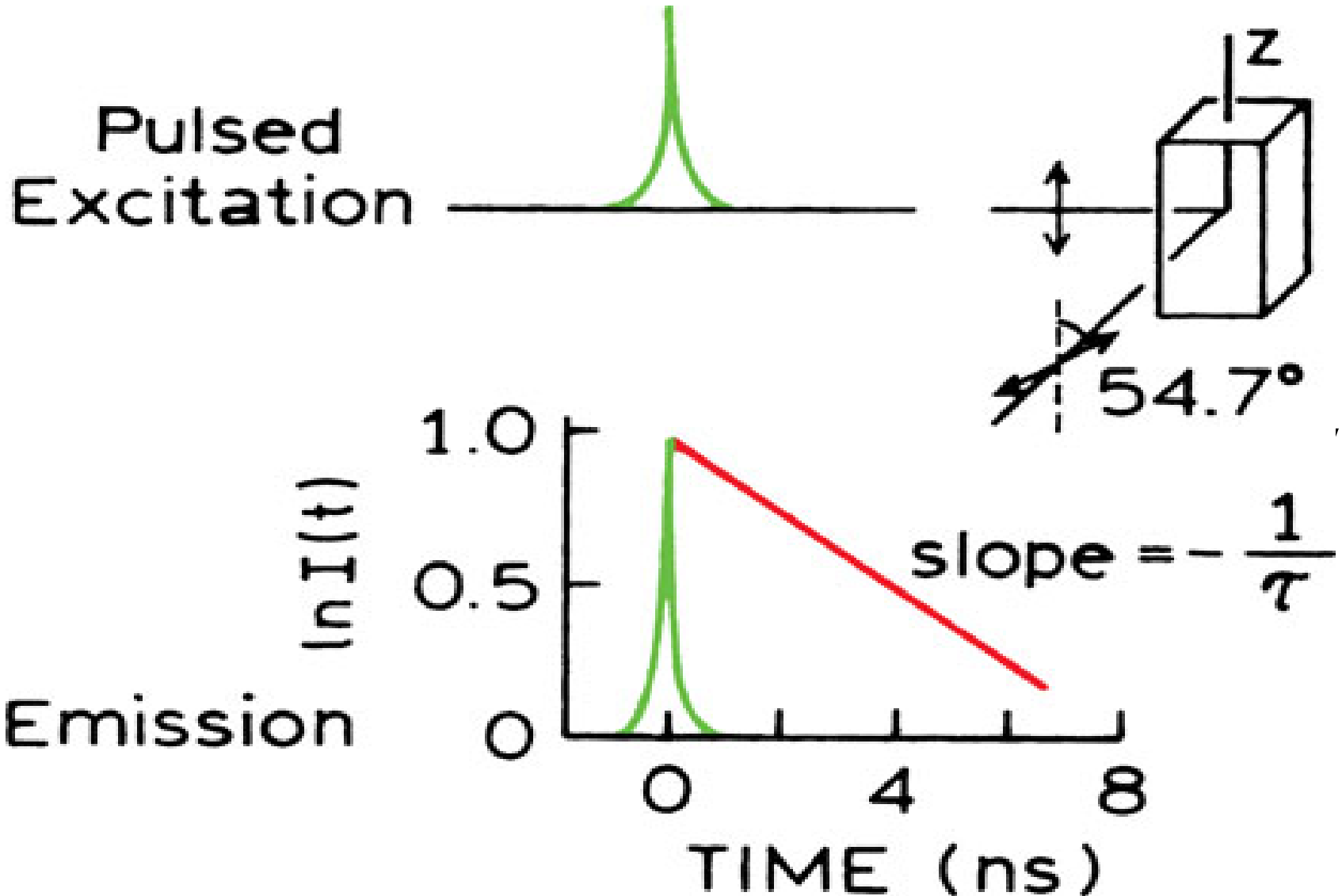

Counting of photons: Time-Correlated Single Photon Counting TCSPC

One emitted photon can be detected with each pulse of excitation light.

A typical arrangement is one photon per 100 excitation pulses.

Time between the excitation pulse and detected photon is measured.

Histogram which illustrates the temporal distribution of photons is created.

Is necessary to have a set of at least 4000 photons to evaluate a lifetime curve.

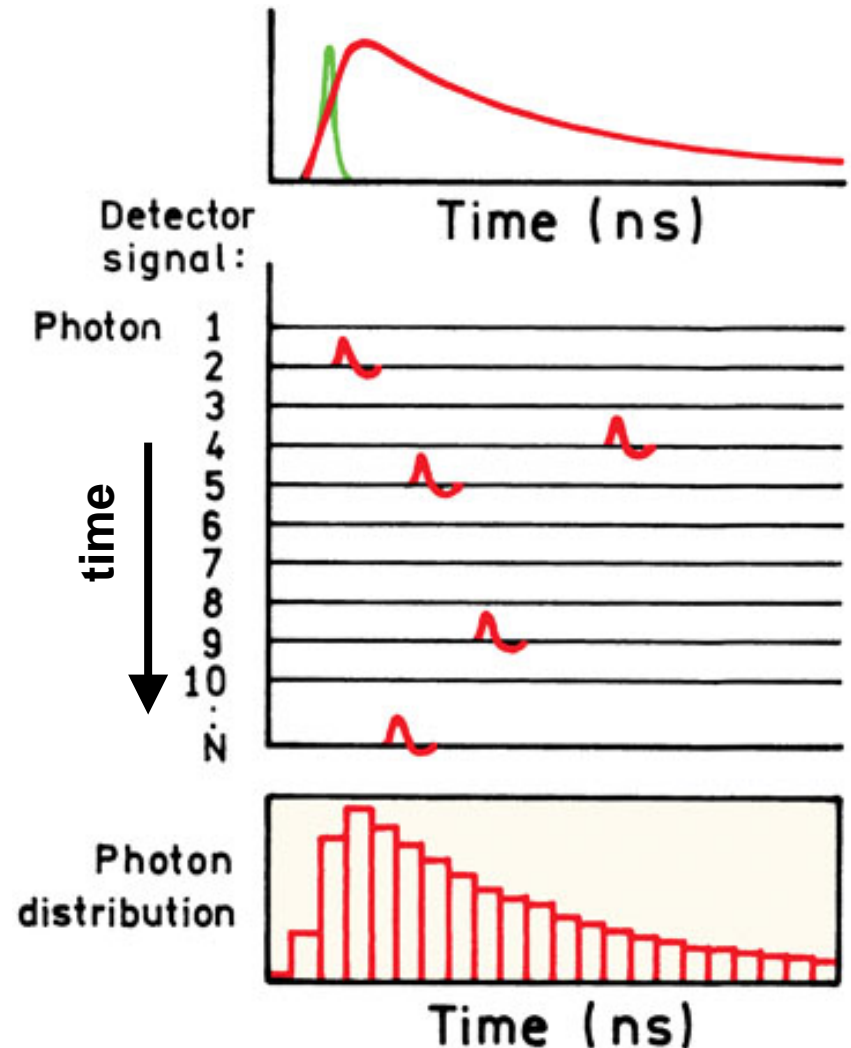

Sources for TCSPC

Laser diodes

Pulse width FWHM = 70 ps (full width at half of maximum)

Pulse repetition rate 40 MHz

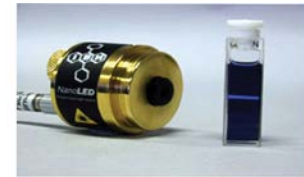
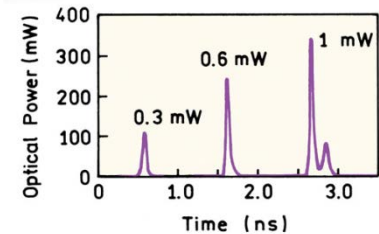

LED (Light Emitting Diode)

FWHM = 1,4 ns (full width at half of maximum)

Pulse repetition rate 40 MHz

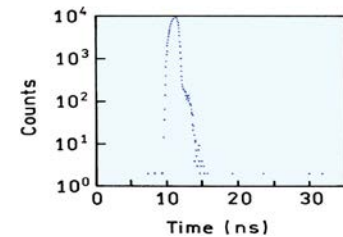

Detector - photomultiplier

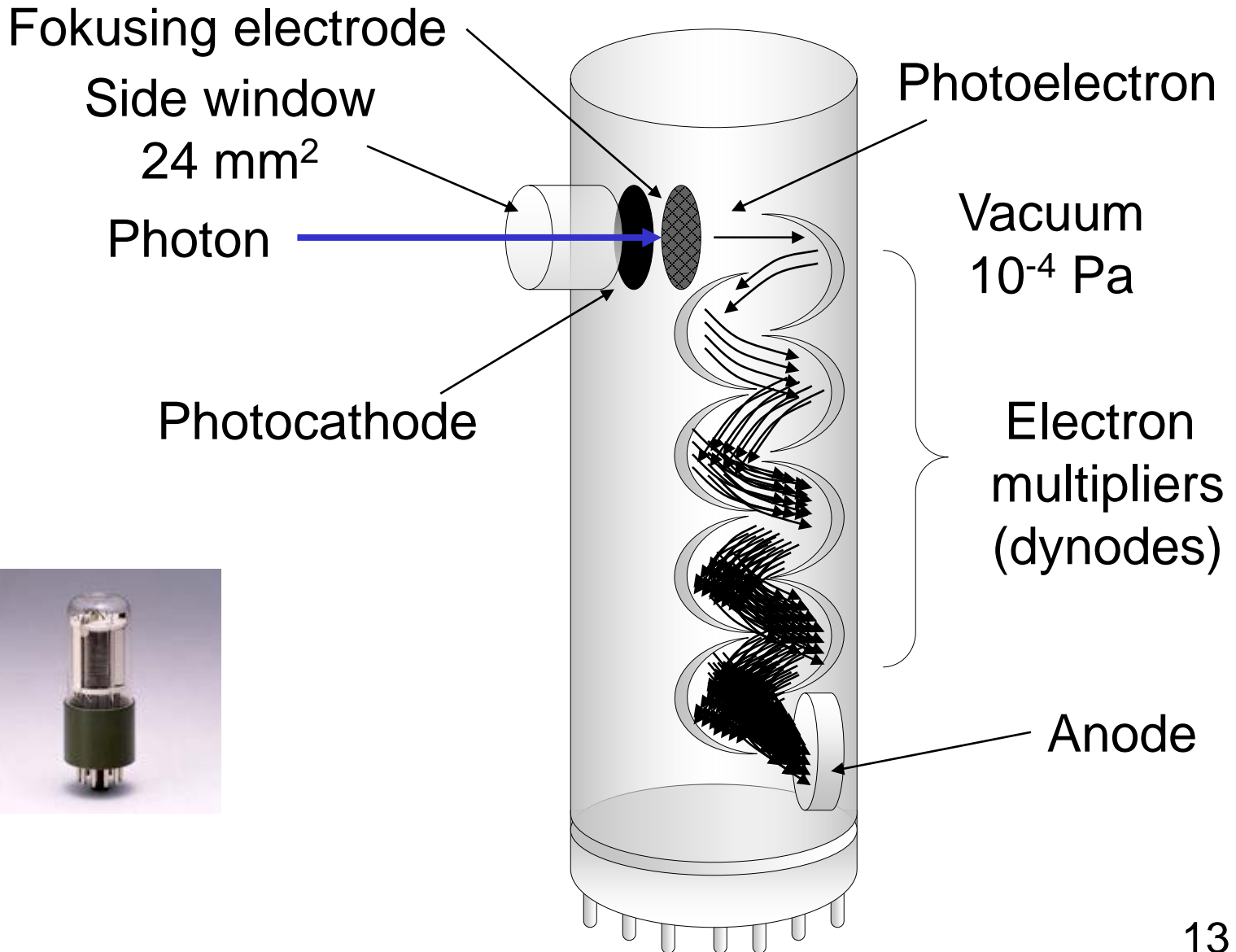

Fast detector (MCP PMT)

- It is the most important when monitoring the time dependence of the fluorescence
- Currently the fastest one are the microchannel plate photomultiplier (MicroChannel Plate PhotoMultiplier Tube)
- They have a quick response, the electron travels in a detector less than 1 ns. In comparison with the conventional photomultiplier the response is 10 times faster.

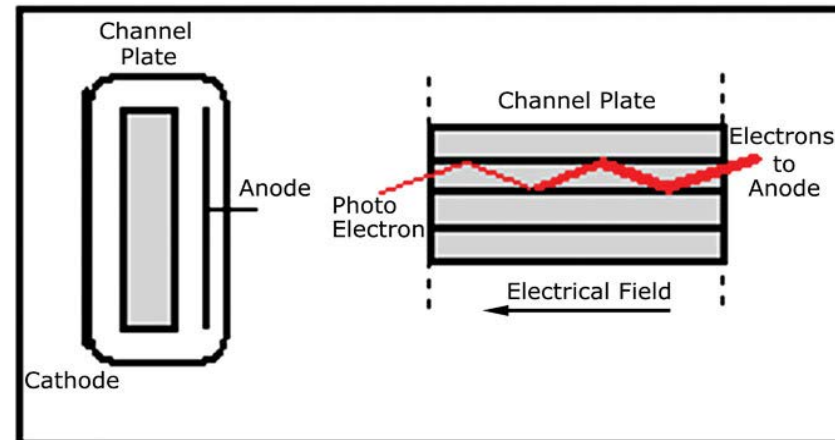
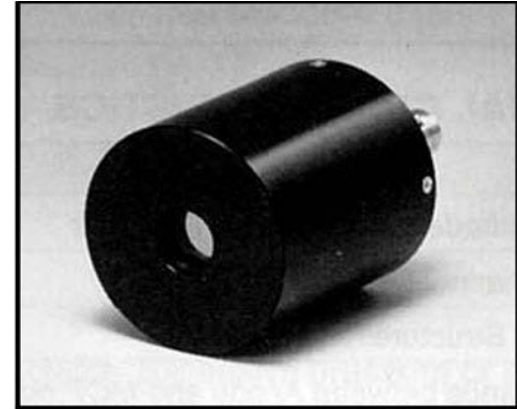

Principle of devices with TCSPC

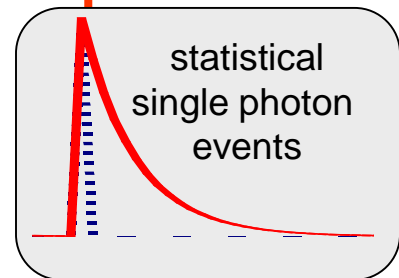
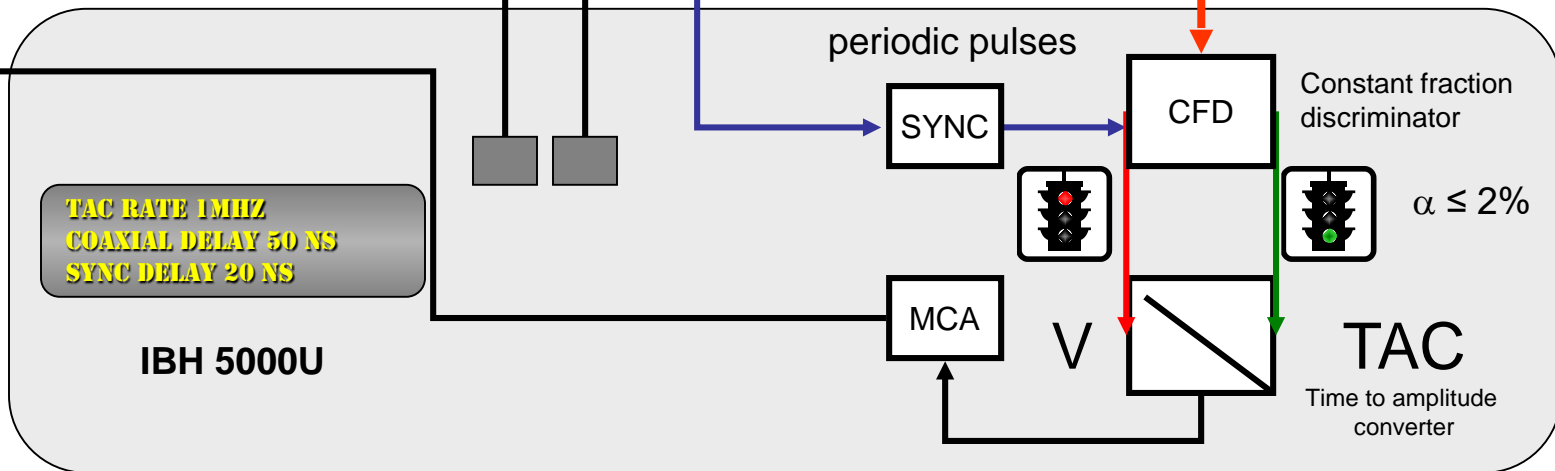
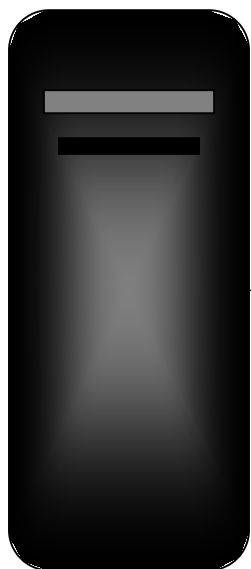
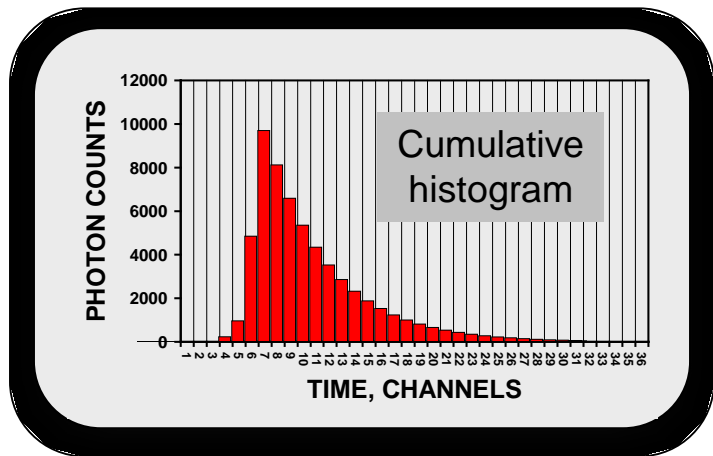

Practical determination of τ

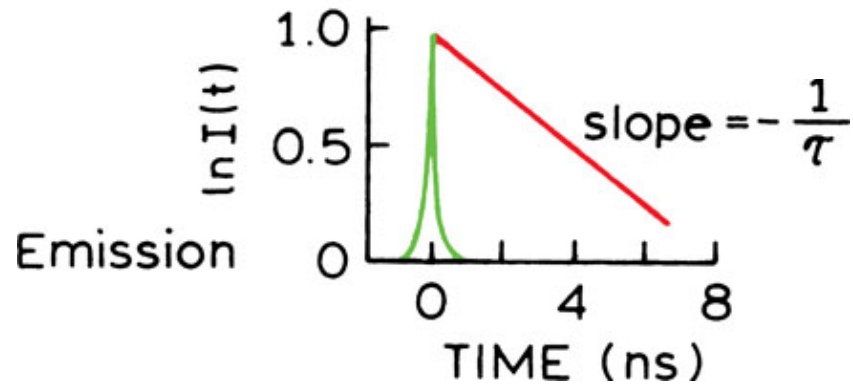

$$I_{(t)} = I_0 e^{-t/\tau}$$

$$I_{(\tau)} = I_0 e^{-1} = I_0 \cdot 0.37$$

Principle of composing (convolution) signals

Intensity is a function of time:
 $I(t) = \alpha \exp(-t/\tau)$

Intensity of the light source is also a function of time
 $L(t)$

Convolution of fluorescence:
 $F(t) = I(t) \otimes L(t)$

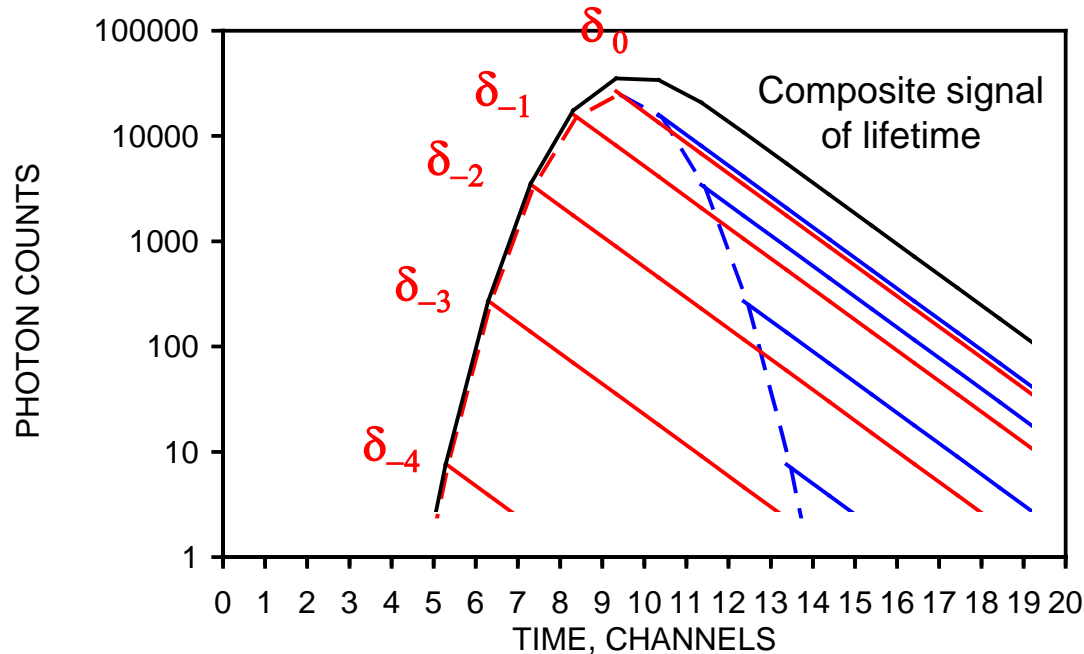
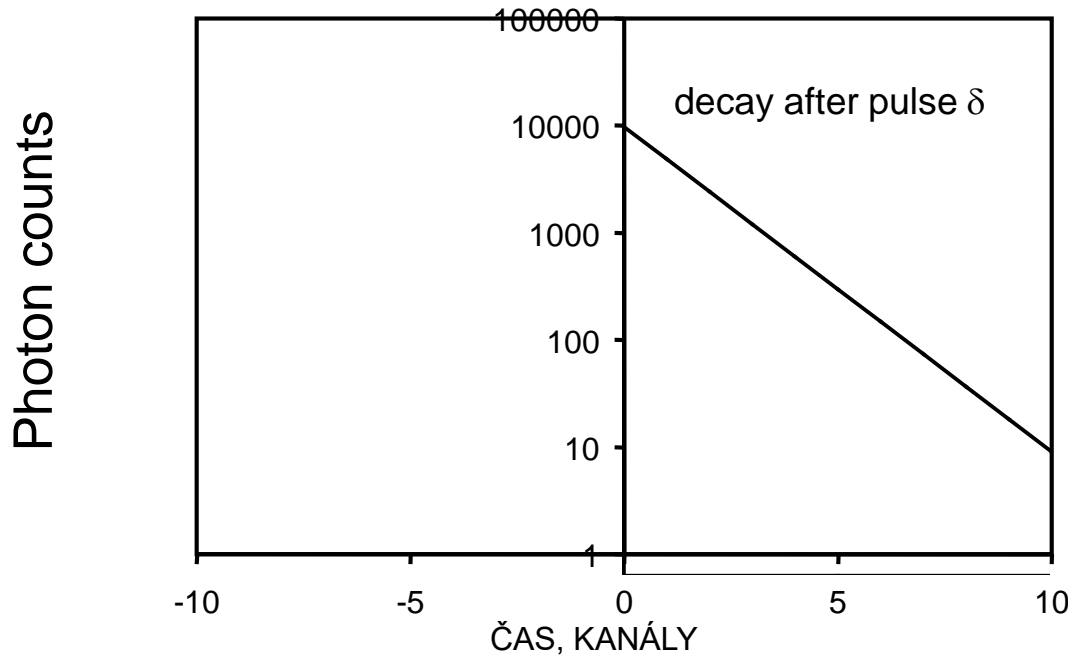

Time-resolved fluorescence of fluorescein

- Fluorescein in water at pH 9.0
- Excitation 450 nm
- Pulse LED with repetition rate 20 MHz

IRF Instrument Response Function
signal of the source and response
of the instrument

IRF is the curve corresponding to
the shortest possible lifetime,
which can be measured
on the instrument

IRF

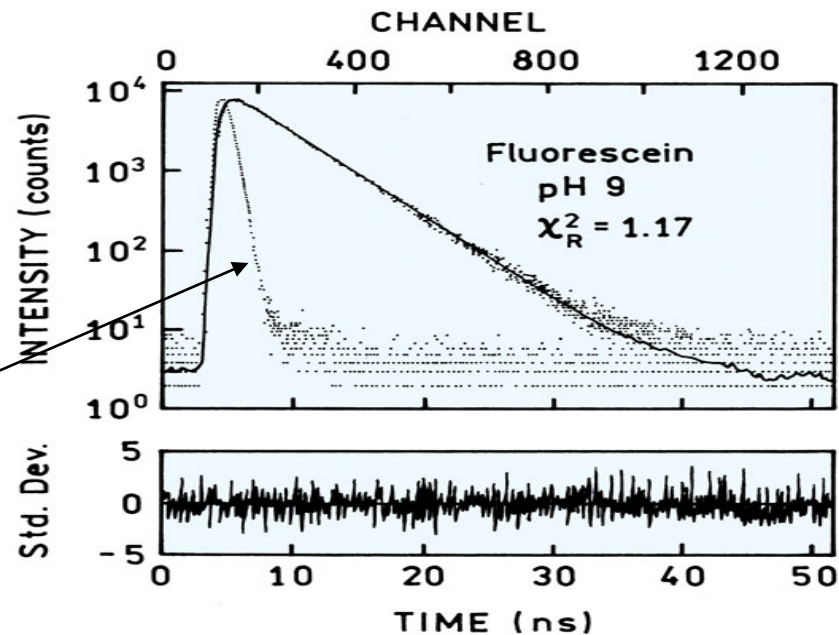

More fluorophores in the system: multi-exponential decay

$$I_{(t)} = \alpha_1 e^{-t/\tau_1} + \alpha_2 e^{-t/\tau_2} \dots + \alpha_N e^{-t/\tau_N}$$

$$I_{(t)} = \alpha_i \exp(-t/\tau_i)$$

- α_i proportional representation of fluorophore
- τ_i lifetime of given fluorophore
- The total intensity is the sum of (convolutions) contributions from each fluorophore
- In the analysis it is necessary to use deconvolution - signal decomposition on the contributions of individual fluorophores

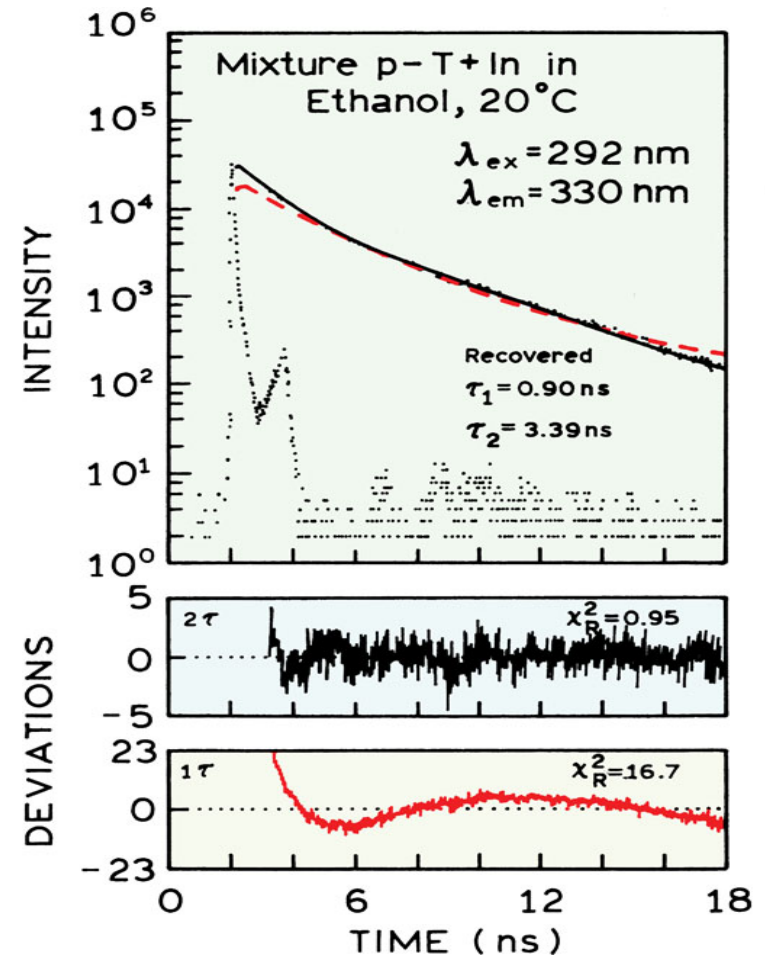

Resolution of composing signals from two fluorophores (deconvolution)

- In determining contributions from individual fluorophores, sometimes it is not possible to determine precisely α and τ , because their various combinations can be used for the same curve fitting
- Various pairs α_i and τ_i can give very similar shape of the decay curve

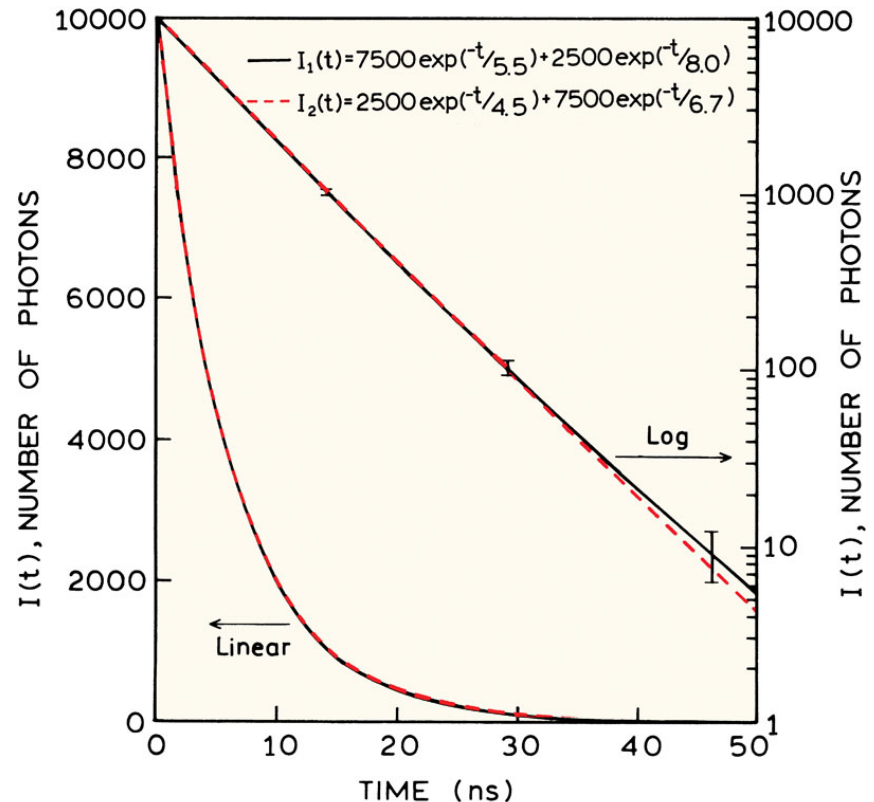

Time-resolved fluorescence of human serum albumin HSA

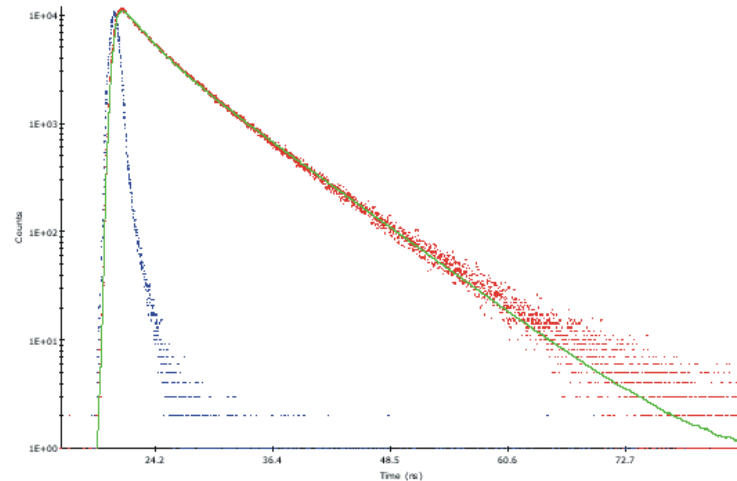
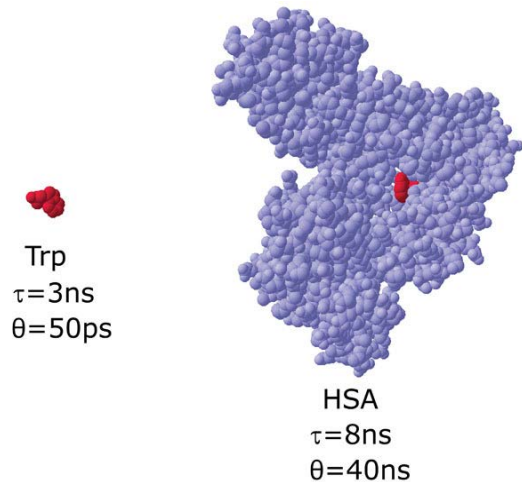

Fluorophore is tryptophan

There is only one tryptophan in the protein, nevertheless the time dependence of decay is multi-exponential.

It is caused by different conformations of the protein in solution.

Tryptophan is found in several different local environments.

Two-exponential fit residuals. Chisq 1.36

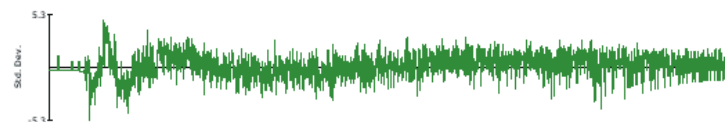

Three-exponential fit residuals. Chisq 1.04

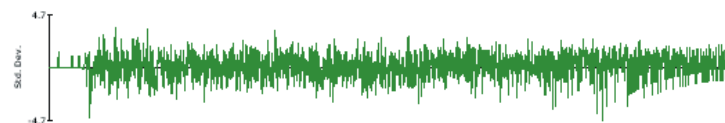

Method of phase-modulated excitation radiation

1. The sample is excited with sinusoidally modulated light with high frequency range comparable with reciprocal value of the lifetime
2. When the sample is excited by the modulated wavelength, emitted wavelength of fluorescence corresponds to the modulation frequency of the absorbed excitation light
3. Emission is time-delayed in comparison with the excitation light, resulting in a phase shift. Phase shift is used to calculate fluorescence lifetime τ

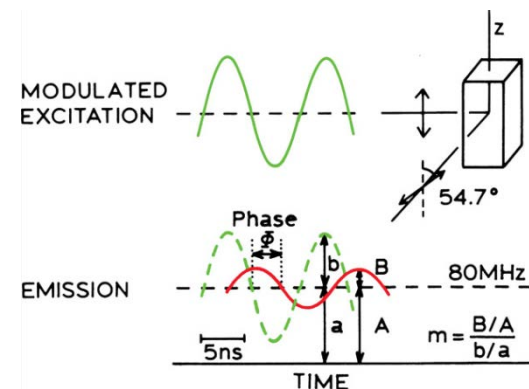

Determination of lifetime using method of phase-modulation

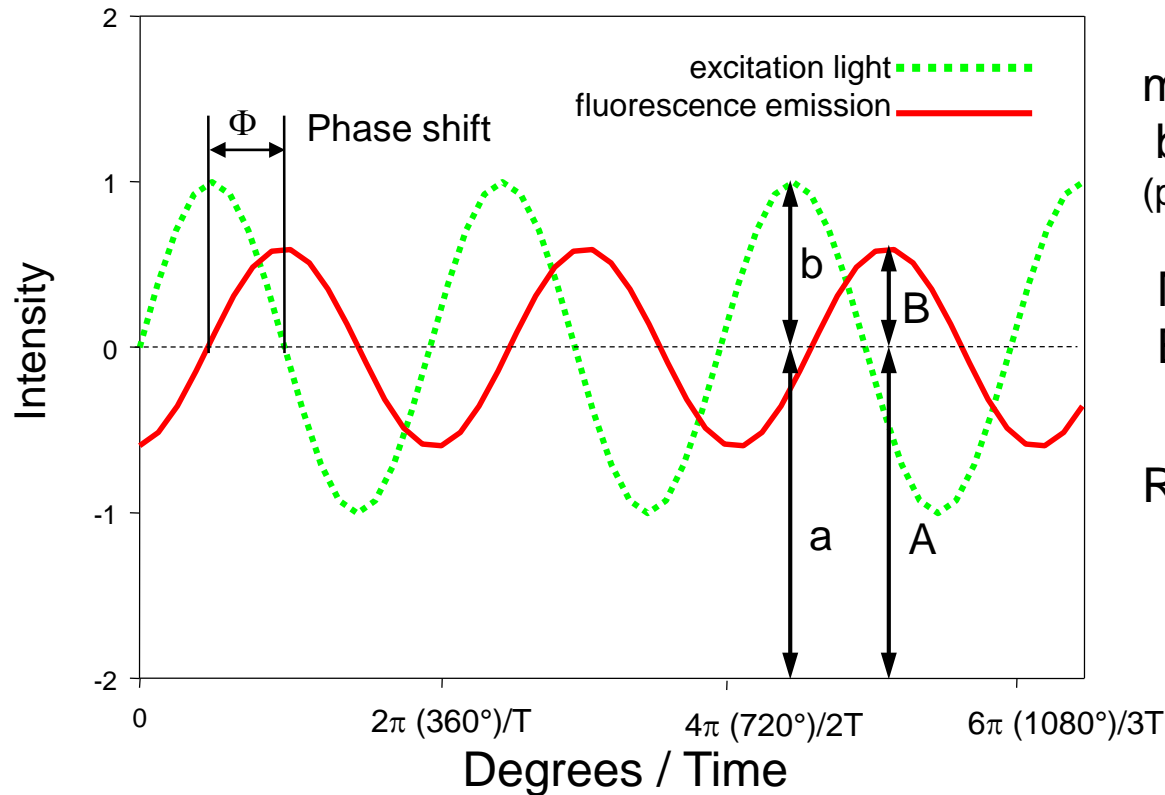

modulation of excitation
 b/a
 (peak height / middle intensity)

Modulation of emissions
 B/A

Relative modulation m

$$m = \frac{B / A}{b / a}$$

Determination of lifetime
 from phase shift Φ

$$\tan \Phi = \omega \tau_{\Phi}$$

Determination of lifetime
 from modulation m

$$m = \frac{1}{\sqrt{1 + \omega^2 \tau_m^2}}$$

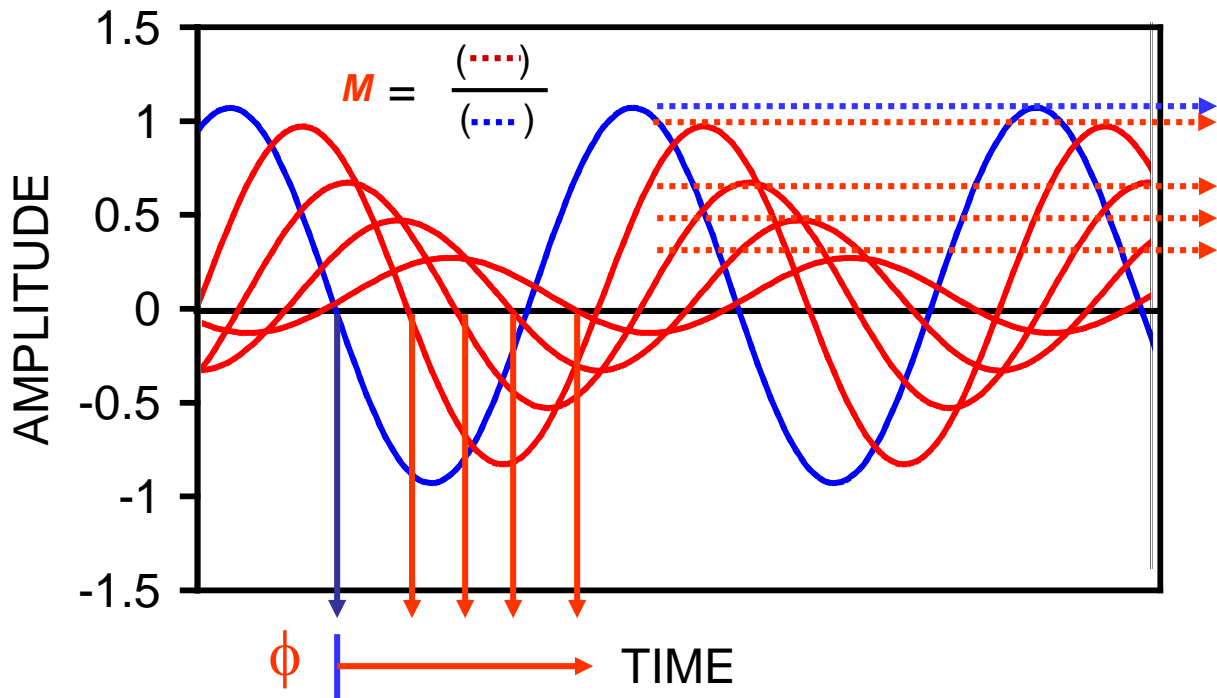

Principle of measurement using phase modulation

$$m = \frac{B/A}{b/a}$$

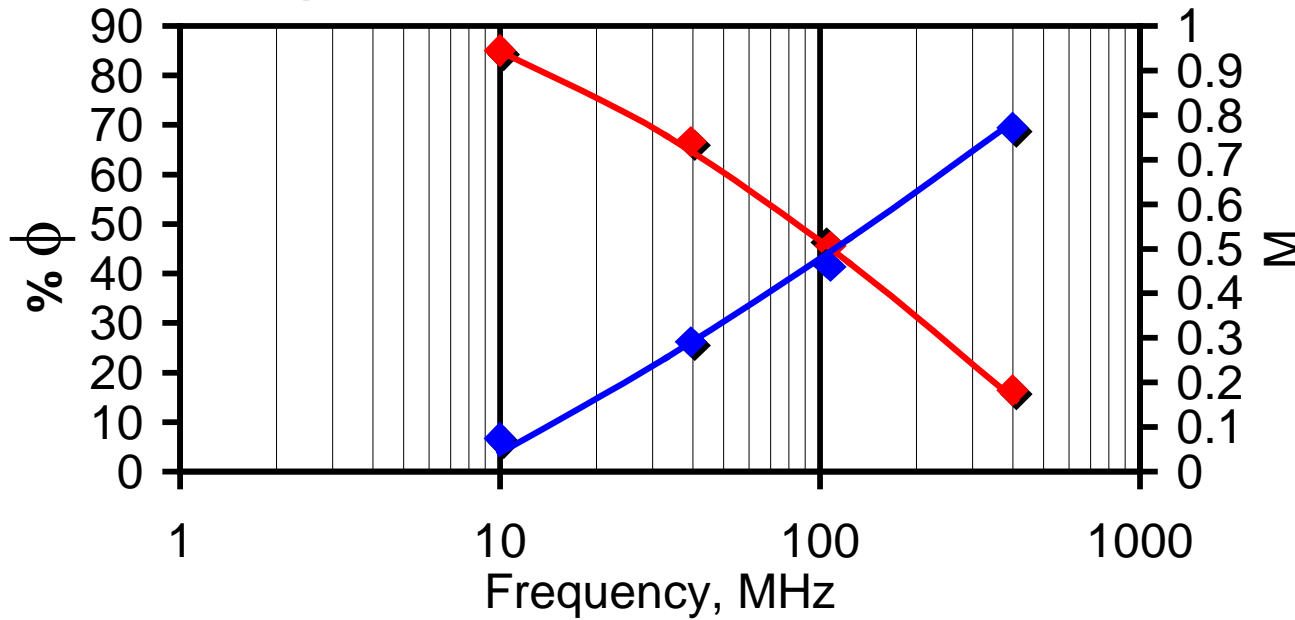

Example of calculation

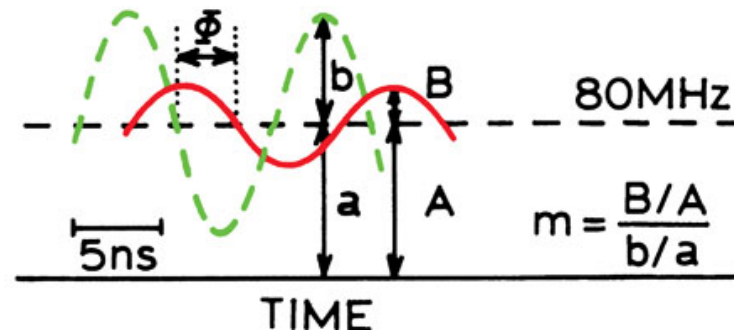

$$\Phi = 68^\circ$$

$$m = 0.4$$

$$\tan \Phi = \omega \tau_\Phi$$

$$m = \frac{1}{\sqrt{1 + \omega^2 \tau_m^2}}; \quad \omega = 2\pi \cdot f$$

$$\tau_\Phi = \frac{\tan \Phi}{\omega}$$

$$\tau_m = \sqrt{\frac{1}{\omega^2} \left[\frac{1}{m^2} - 1 \right]}$$

Dependence of parameters obtained by method of phase modulation on τ

- The shorter lifetime τ , the larger shift of intersection curves to higher frequencies
- For longer lifetime $\tau = 10 \mu\text{s}$ is necessary to use the modulation frequencies 10 kHz - 1 MHz
- For shorter lifetime $\tau = 100 \text{ ps}$ is necessary to use the modulation frequencies up to 2 GHz, thus 10,000-fold higher

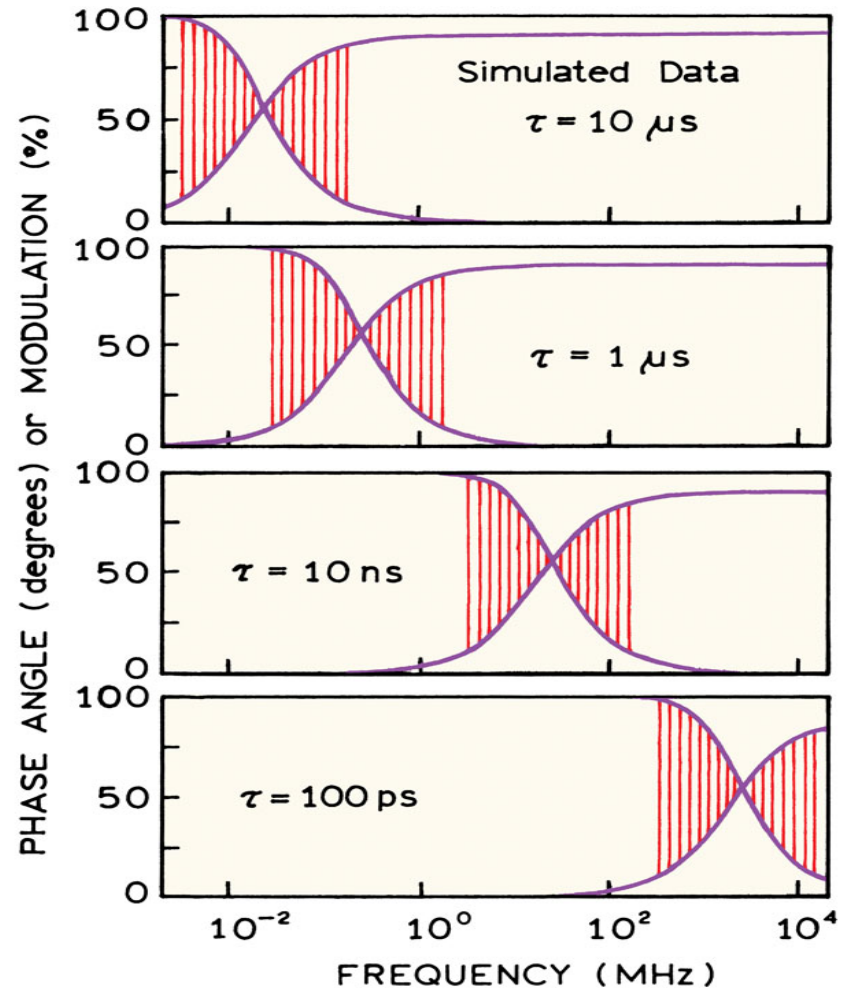

Time-resolved fluorescence of fluorophores in a different environment

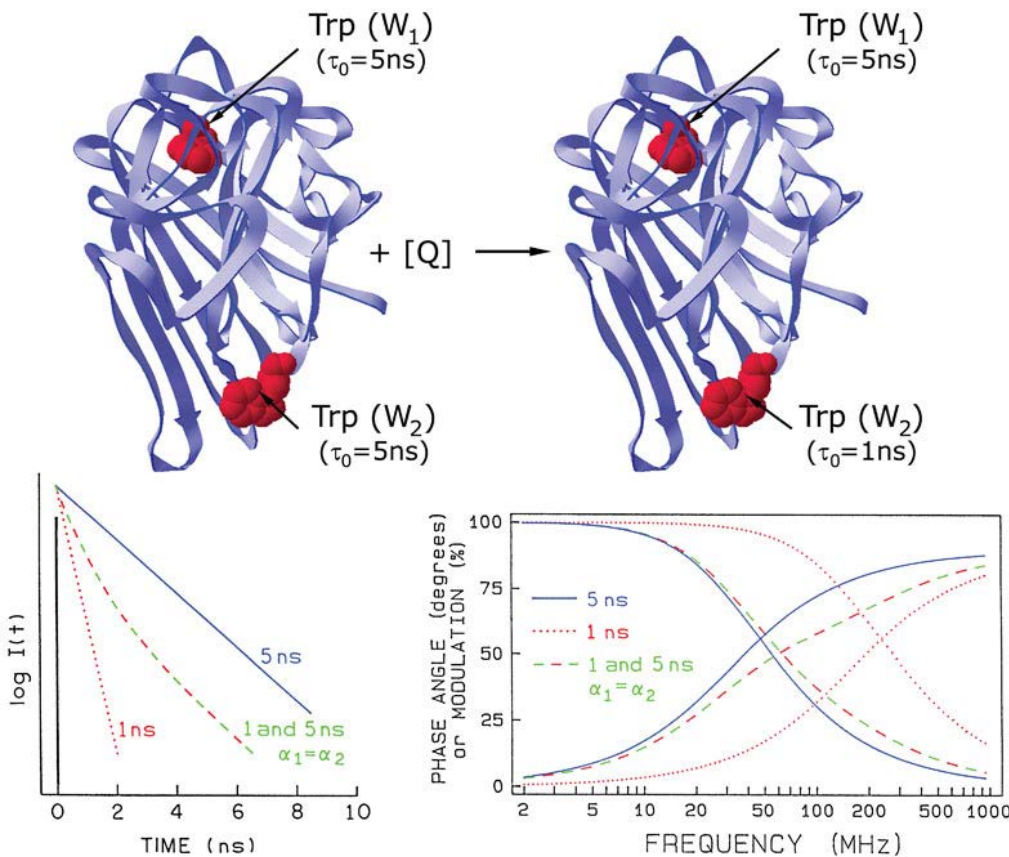

- Protein with two fluorophores - tryptophans

$$I_{(t)} = \alpha_1 e^{-t/\tau_1} + \alpha_2 e^{-t/\tau_2}$$

- Fluorophores have the same value τ in the same environment
- After adding of quencher the fluorescence lifetime is reduced for the fluorophore on the surface τ_2
- The result is "bent" curve
- The task of deconvolution is then to determine τ_1 , τ_2 and the relative contributions of fluorophores α_1, α_2

Change in rotational correlation time during the protein multimerization

- The time dependence of the polarized fluorescence can be used to monitor changes in the dynamics of molecules
- Observation of phosphofructokinase multimerization

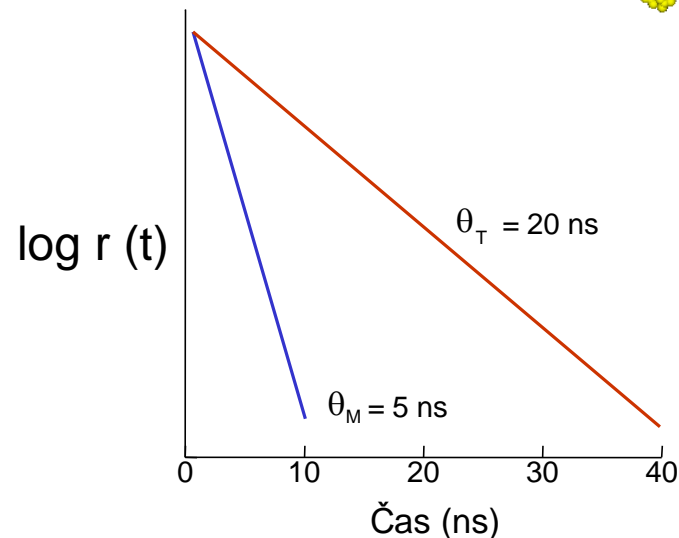
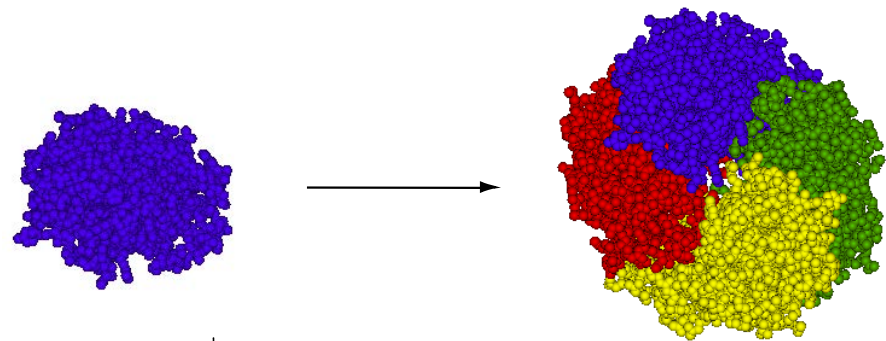

Fluorescence LifeTime Imaging Microscopy

FLIM



- Observation of time dependence of fluorescence in 2D space
- It enables to distinguish an environment in which the fluorophores are located
- It enables to observe quenching of fluorophores, either due to environmental influences, quenchers or interactions with other molecules

Using FLIM for monitoring protein interaction

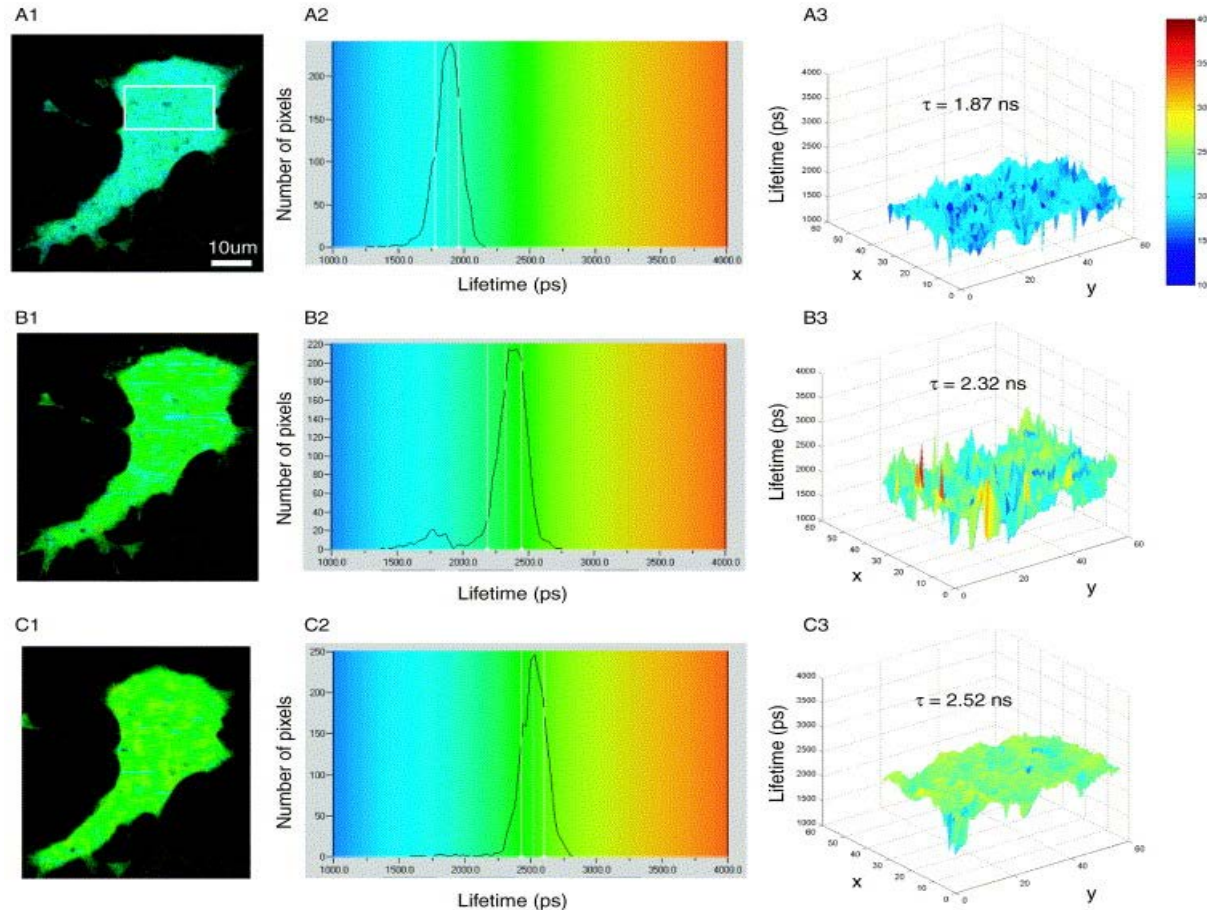

Faster decay in the presence of quenching protein

Normal - slow decay

Interaction or colocalization?

Example FRET-FLIM Colocalisation or Interaction?

B = donor (FITC)
A = acceptor (Cy3)
C = acceptor (Cy3)

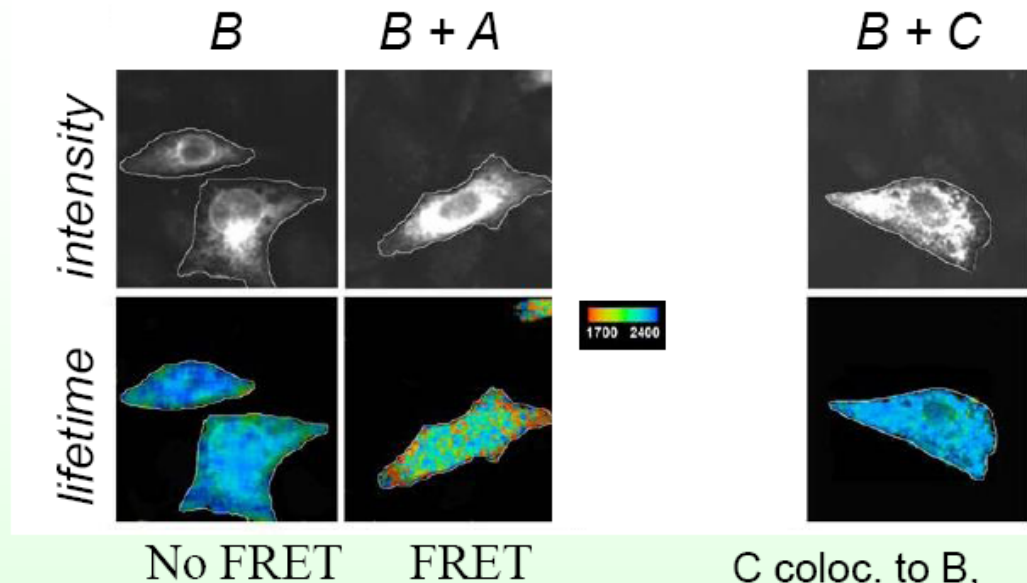

Conclusion:
A interacts with B (shift blue to red)

Example of detailed display of FLIM

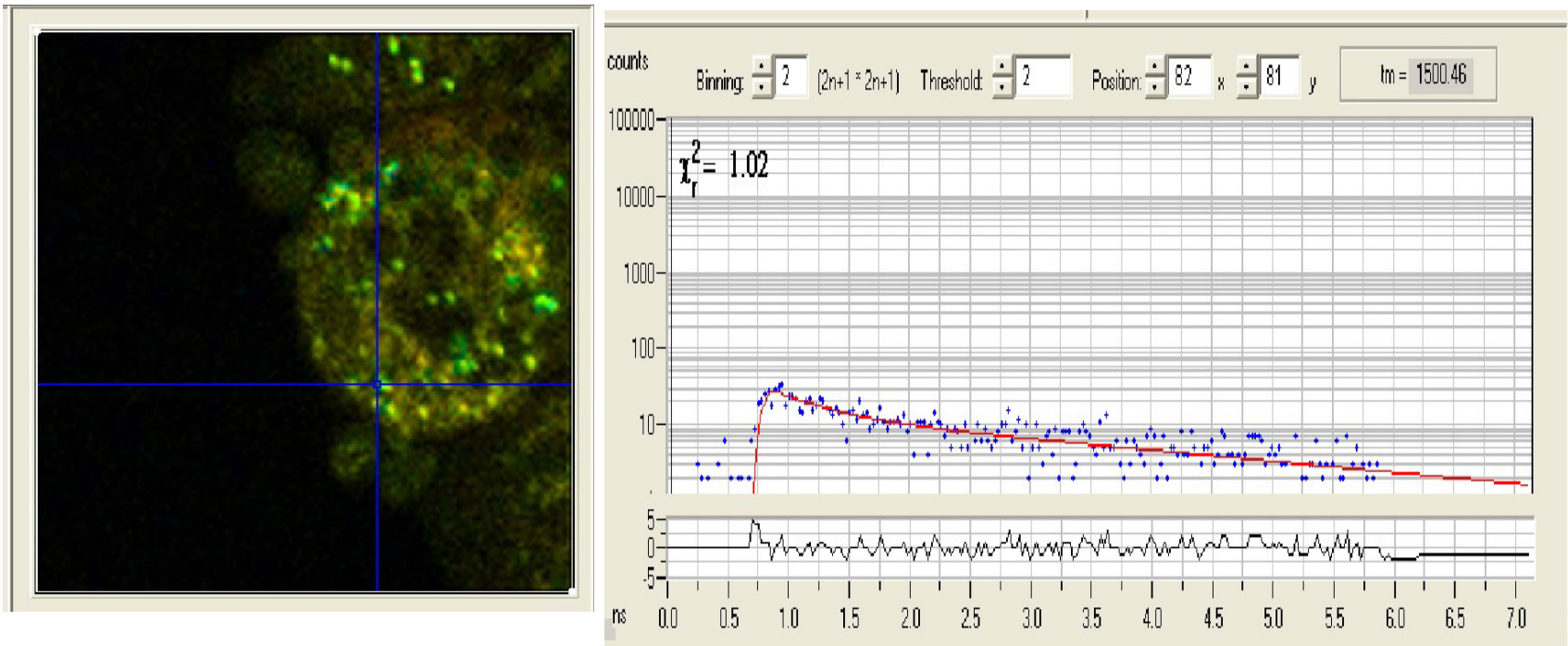

Dependence of fluorescence lifetime of NADH is a two-exponential with a value of 0.4 ns for free and 3 ns for bound NADH molecule.

Using of time-resolved fluorescence in proteomic analysis

Intensity

Time resolution

Gel stained with Sypro-Ruby

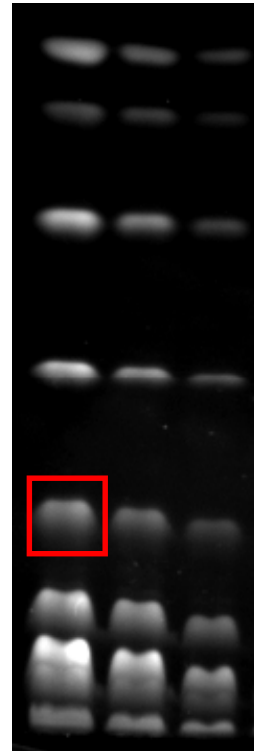

The intensity is supplemented with a pseudo-color time resolution to visualize both parameters at the same time.

Time-resolved fluorescence can help in the analysis of proteins in overlapping bands.

Literature

- Lakowicz J.R.: Principles of Fluorescence Spectroscopy. Third Edition, Springer + Business Media, New York, 2006.
- Fišar Z.: FLUORESCENČNÍ SPEKTROSKOPIE V NEUROVĚDÁCH
<http://www1.lf1.cuni.cz/~zfiisar/fluorescence/Default.htm>

Acknowledgment

Graphics from the book Principles of Fluorescence was for the purpose of this lecture kindly provided by Professor JR Lakowitzem.