

Trace element analysis of geological materials by ICP-MS I

DSP analytical geochemistry

C9067

Markéta Holá, MU Brno



EVROPSKÁ UNIE
Evropské strukturální a investiční fondy
Operační program Výzkum, vývoj a vzdělávání



MINISTERSTVO ŠKOLSTVÍ,
MLÁDEŽE A TĚLOVÝCHOVY

Tento učební materiál vznikl v rámci projektu Rozvoj doktorského studia chemie
č. CZ.02.2.69/0.0/0.0/16_018/0002593

Outline

1. Mass spectrometry. General introduction and history.
2. Ion sources for mass spectrometry. Inductively coupled plasma.
3. Interface. Ion optics. Mass discrimination. Vacuum system.
4. Spectral interferences. Resolution, ion resolution calculations.
5. Mass analyzers. Elimination of spectral interferences.
6. Non-spectral interference.
7. Detectors, expression of results.
8. Introduction of samples into plasma.
9. Laser ablation for ICP-MS.
10. Excursion in the laboratory.

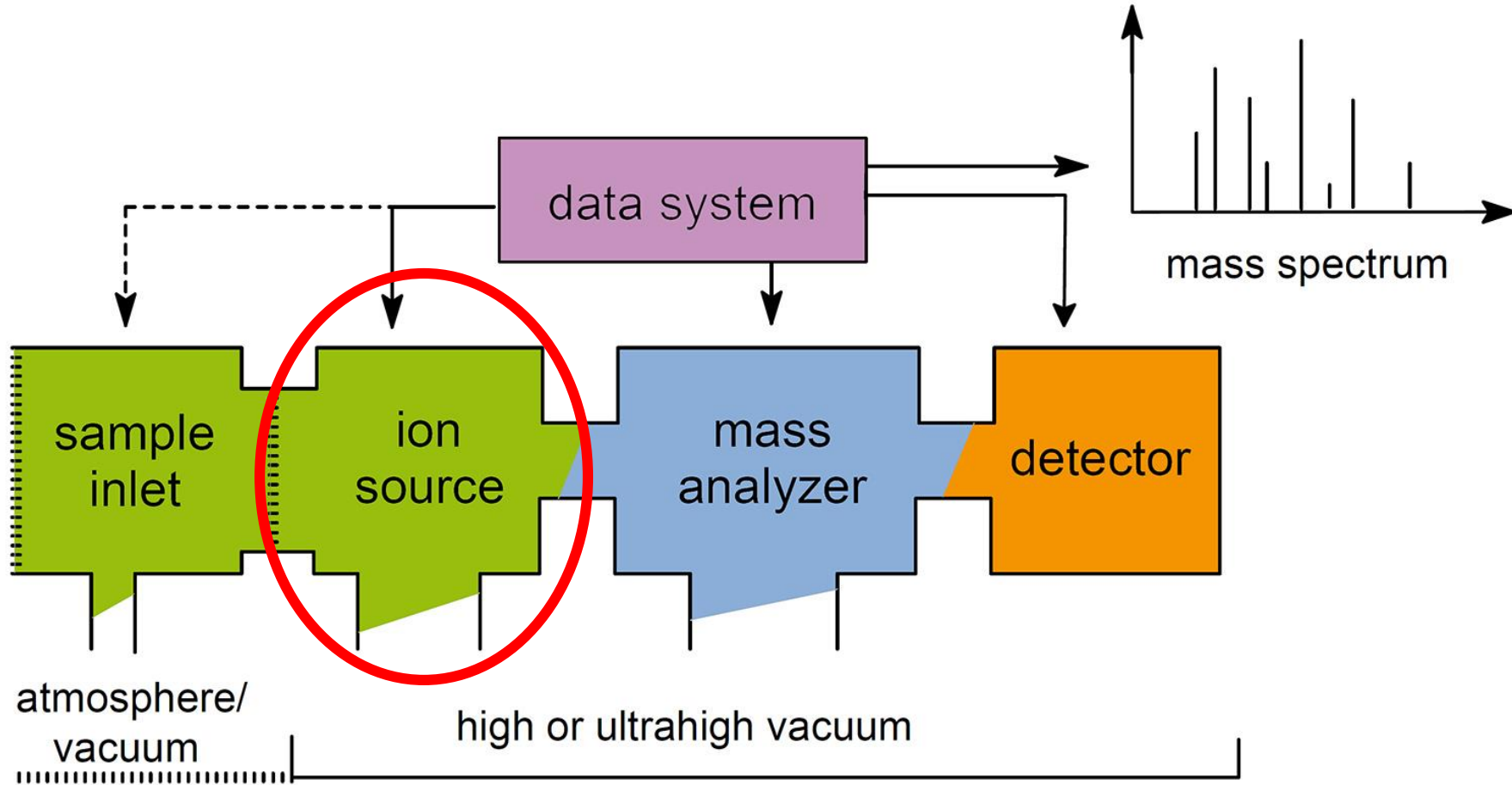

1000 mbar 10^{-5} to 10^{-6} mbar 10^{-6} to 10^{-9} mbar

Ion sources in mass spectrometry

in general

- Electron ionization (EI)
- Chemical ionization (CI)
- Matrix assisted laser desorption ionization (MALDI)
- Electrospray ionization (ESI)
- Inductively Coupled Plasma (ICP)
- Secondary ion mass spectrometry (SIMS)
- Glow discharge (GD)
- Plasma desorption (PD)
- Laser desorption (LD)



molecules



atoms

Electron ionization (EI)

electron impact, electron bombardment

- Electrons are emitted from glowing filament (tungsten, rhenium) by thermionic emission and accelerated by a potential of 70 V applied between the filament and anode



where M is the atom or molecule being ionized

- “Hard” ionization method – ionization and fragmentation occur simultaneously
- Incompatible with liquid streams
- Widely used with gas chromatography

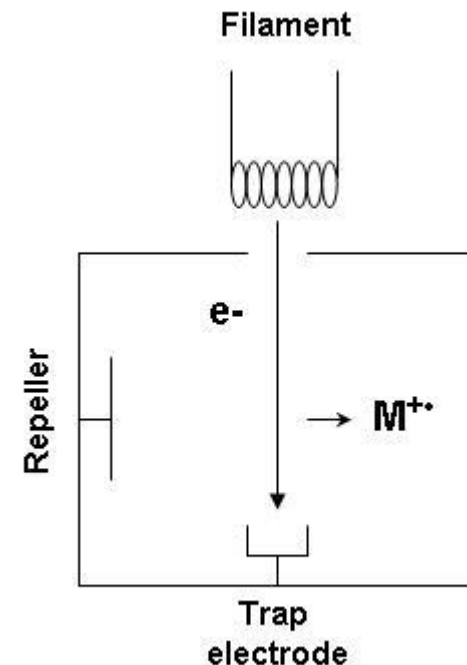

Chemical ionization (CI)

- Lower energy process than electron ionization because it involves ion/molecule reactions rather than electron removal.
- Similar to EI, but with reaction gas G (CH₄, butane, H₂, NH₃, etc.)
- „soft“ ionization technique



G⁺ production



Charge transfer

Matrix assisted laser desorption ionization (MALDI)

- UV (IR) absorbing matrix is energized by the laser matrix molecules desorbed from the surface carry analyte molecules into the gas phase proton transfer from matrix (acid) to analyte in the gas phase (UV (IR) lasers (N₂, Nd:YAG...))
- Energy of the laser is absorbed by the matrix
 - e (matrix) >> e (analyte), c (matrix) >> c (analyte)
 - Matrix **MH⁺, M⁺, M^{*}**, fragments, ion fragments
 - Analyte, dispersed in matrix, is vaporized with the matrix
- Matrix causes ionization of analyte (proton transfer)

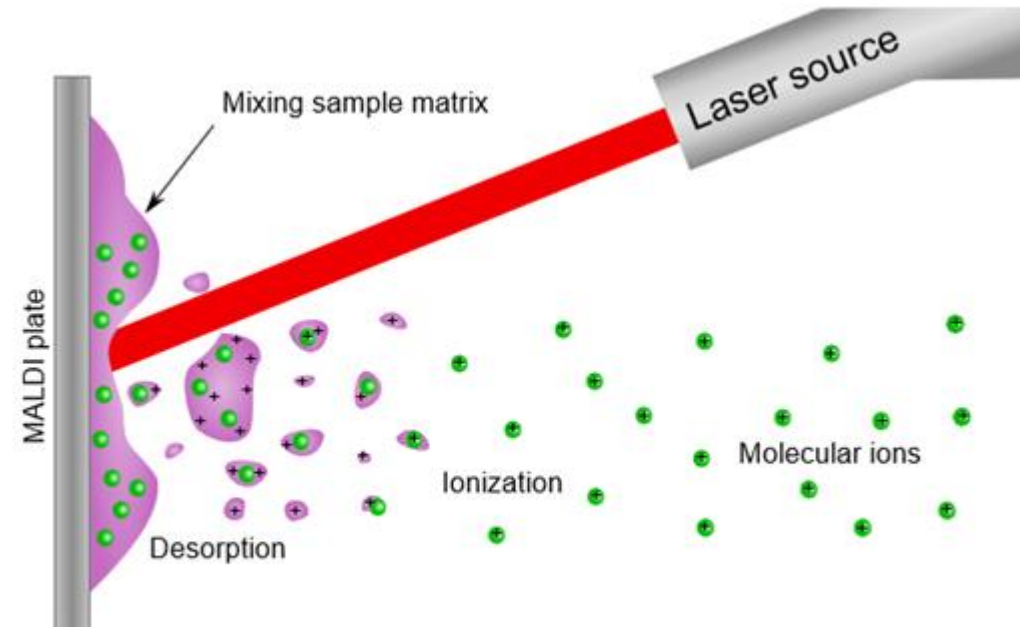
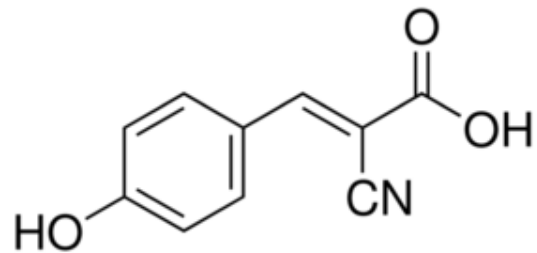

Figure from Wikimedia Commons

Matrix assisted laser desorption ionization (MALDI)

- Analyte samples are co-crystallized with matrix molecules
- Matrices – usually acids due to easy H⁺ transfer



α -cyano 4 hydroxycinnamic acid
(CHCA)

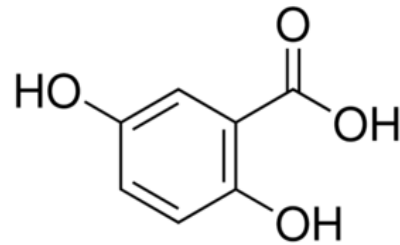

dihydroxy benzoic acid
(DHB)

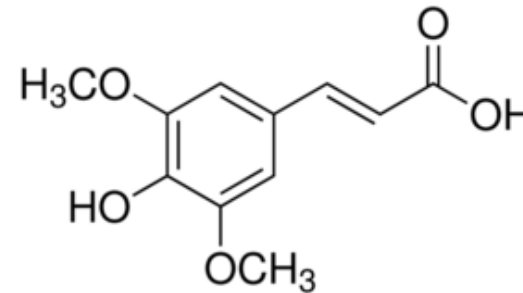

sinapic acid

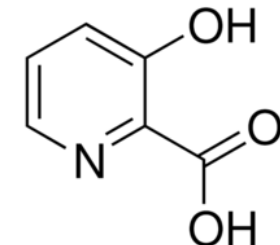

3-hydroxy picolinic acid
(3-HPA)

Electrospray ionization (ESI)

- Liquid is pushed through a very small, charged and usually metal capillary. This liquid contains the analyte, dissolved in a large amount of solvent, which is usually much more volatile than the analyte

- As the solvent evaporates, the analyte molecules are forced closer together, repel each other and break up the droplets (Coulombic fission)

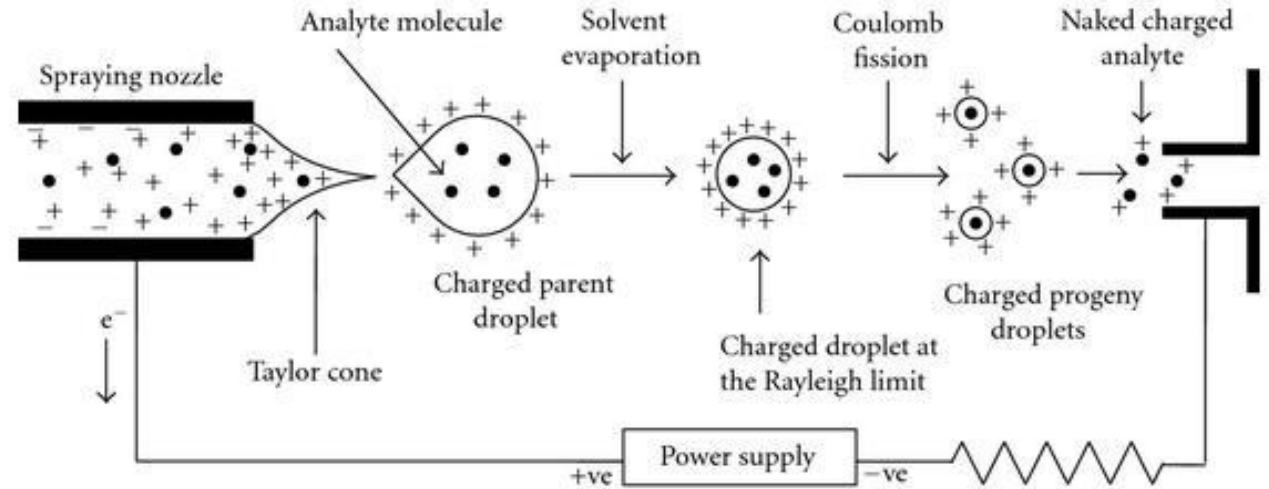

Secondary ions (SI)

- Used for Secondary Ion Mass Spectrometers (SIMS) – ion beam is focused to a selected sample domain. A small percentage of the material sputtered from the polished surface of the sample is ionized, and these ions are accelerated into a mass spectrometer.
- High sensitivity - the ability to count individual ions results in detection limits in the parts-per-billion range for many elements. Isotopic analyses of very small amount of the sample (200 pg).
- Primary ion beam – Cs^+ (probe size ~ 10 nm), O_2^+ , Ar^+ , Ga^+ (provided the smallest probe size ~ 50 nm)

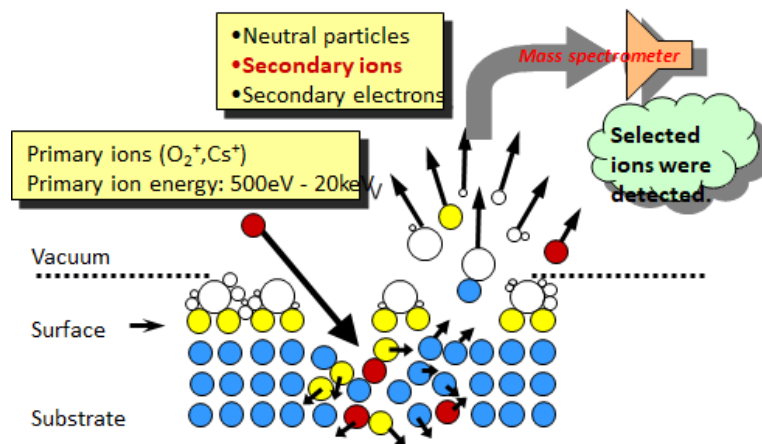

Thermal ionization (TI)

- Used for Thermal Ionization Mass Spectrometry (TIMS) – Ions are created by passing a current through a conducting metal filament, on which the sample is on, to temperatures often exceeding 1000°C under vacuum. Single or double heated filaments of varying materials can be used, dependent on the element to be isotopically analysed. The ions generated are accelerated under vacuum to a magnetic sector where the ions are separated according to their m/z ratio and a detection system.

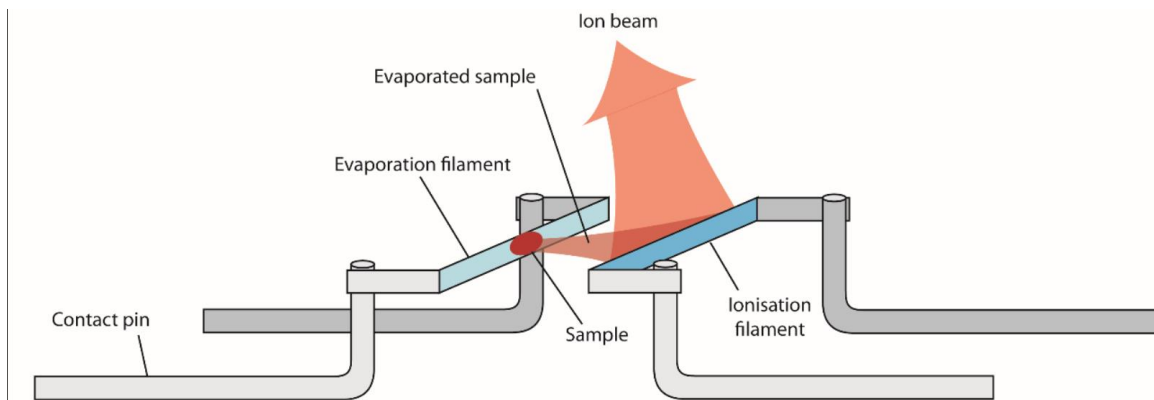

<https://www.nu-ins.com/>

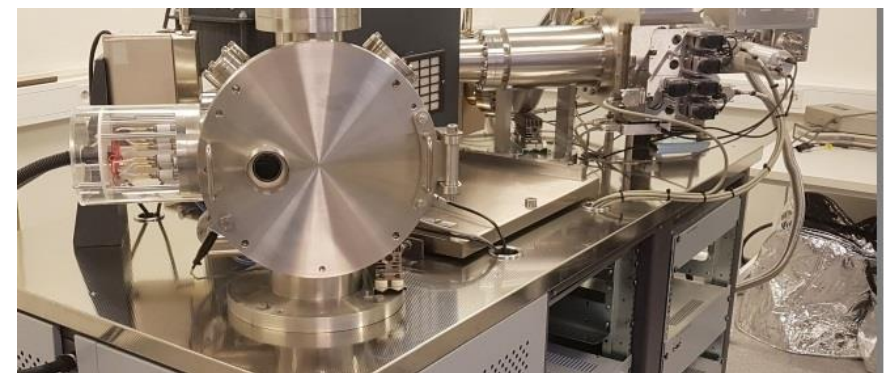

Photo: Lars Eivind Augland, UiO

Gas-discharge ion sources

Plasma source or electric discharge to create ions

- **Inductively-coupled plasma ICP** – energy is supplied by electrical current which is produced by electromagnetic induction (by time-varying magnetic field), 8000 K
- **Microwave-induced plasma MIP** - typically, a 2.45 GHz microwave generator (magnetron) produces a wave that travels through a cable and is focused via a tuning system where a torch sits creating a plasma. The carrier gas continues to flow through the torch and the plasma is self-sustaining. The plasma has a high electron density, 1000 K
- **Glow discharge GD** - a plasma formed by the passage of electric current through a low-pressure gas. It is created by applying a voltage between two metal electrodes in an evacuated chamber containing gas, < 1000 K

Plasma

physical properties

- is one of the four fundamental states of matter, and was first described by chemist Irving Langmuir in the 1920s.
- plasma contains free electric charges, so it is electrically conductive. Thanks to the electrical conductivity, a strong magnetic field also acts on the plasma. With increasing concentration of charged particles, the coefficients of thermal conductivity and dynamic viscosity of the ionized gas change.
- Plasma is mostly quasineutral - the density of positive and negative charges equalizes

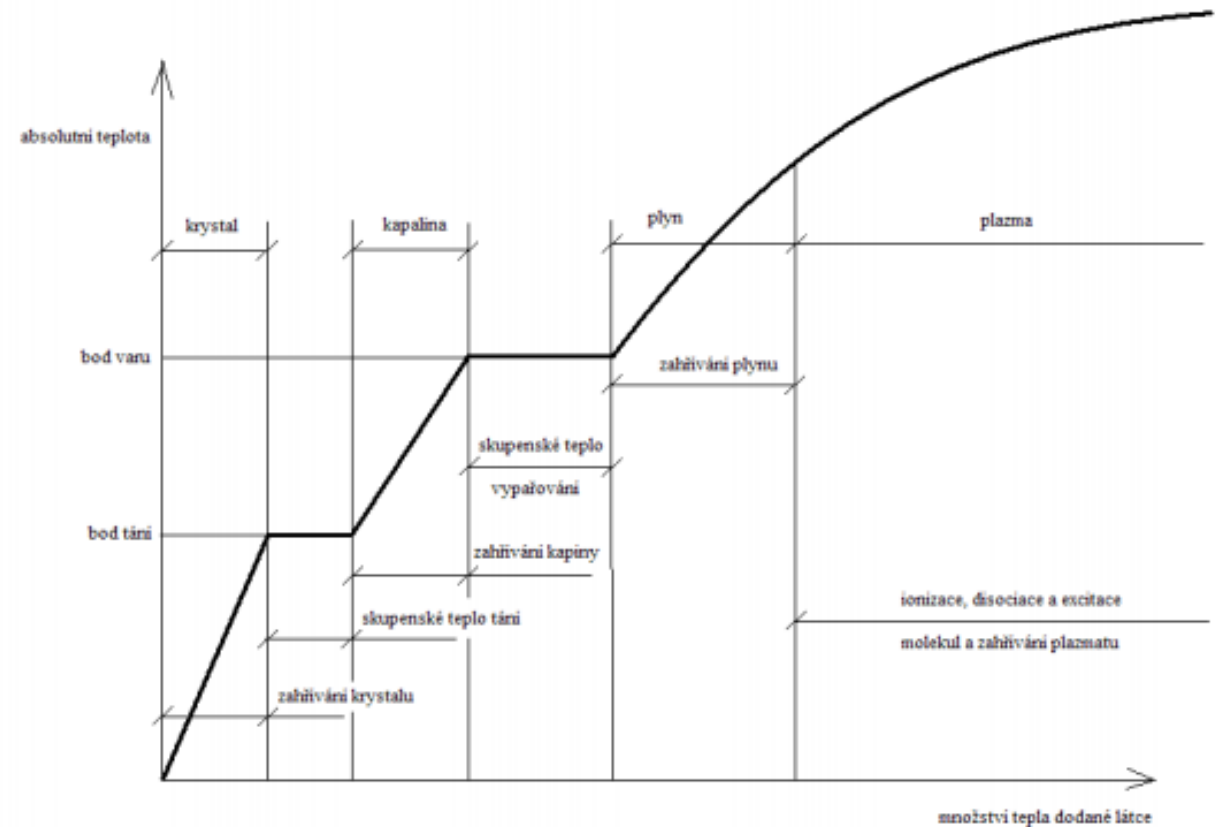

Simplified diagram of the dependence of temperature and state of a chemically pure substance on the supplied thermal energy. (Krejčí, 1974)

Plasma

physical properties

- **solid** – the atoms are tightly bound
- **liquid** – loss of regular arrangement in the grid
- **gas** – molecules move freely
- **plasma** - the molecular gas gradually becomes an atomic gas. Atoms begin to divide - ionize - into free electrons and positively charged residues - ions. Free-moving electrons and ions can carry an electric current, and the substance changes from a gaseous state to a plasma state.

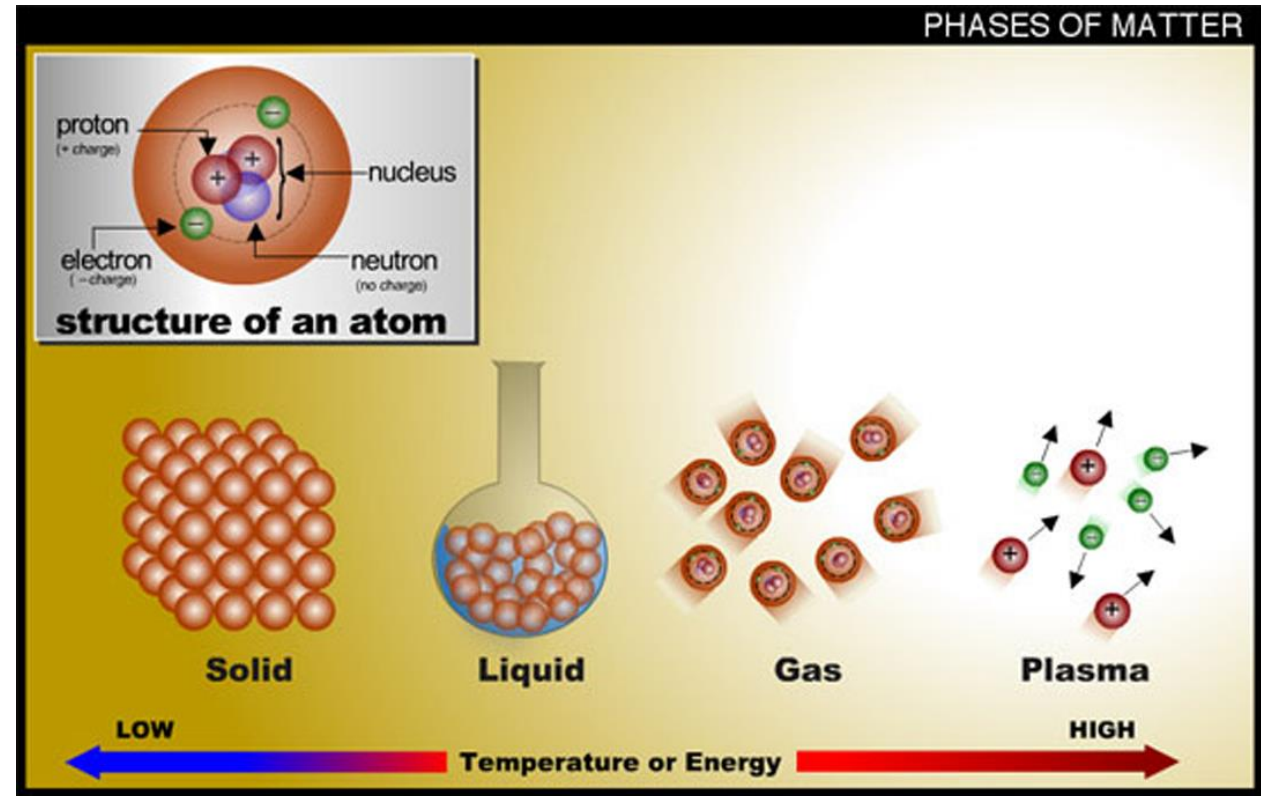

Plasma

physical properties

- 99% of the mass in space is in the plasma state, ie in the form of an electrically conductive gas with atoms dissociated into positive particles and electrons
- the interior and atmosphere of the stars, the solar wind, most of the interstellar hydrogen and gas nebulae are plasma



we live in 1% of the universe, where plasma does not occur naturally

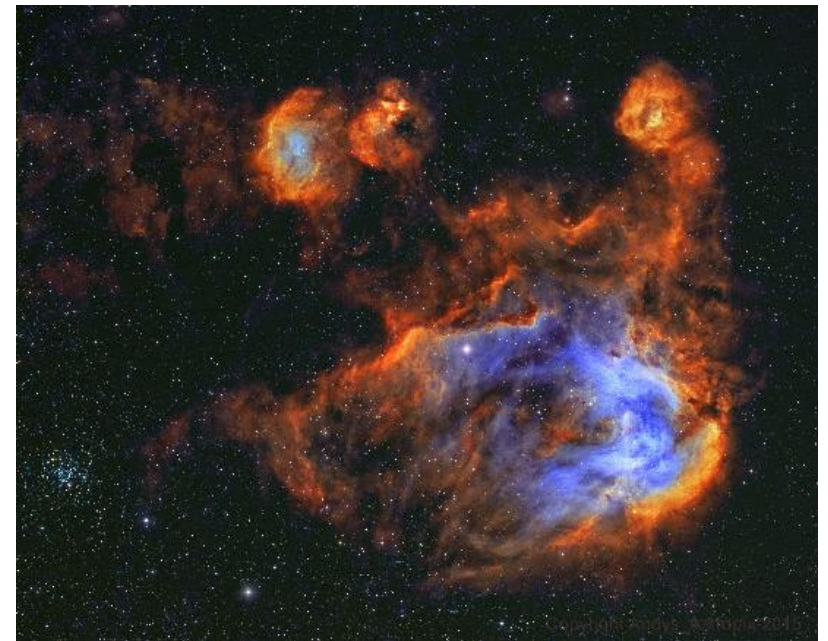
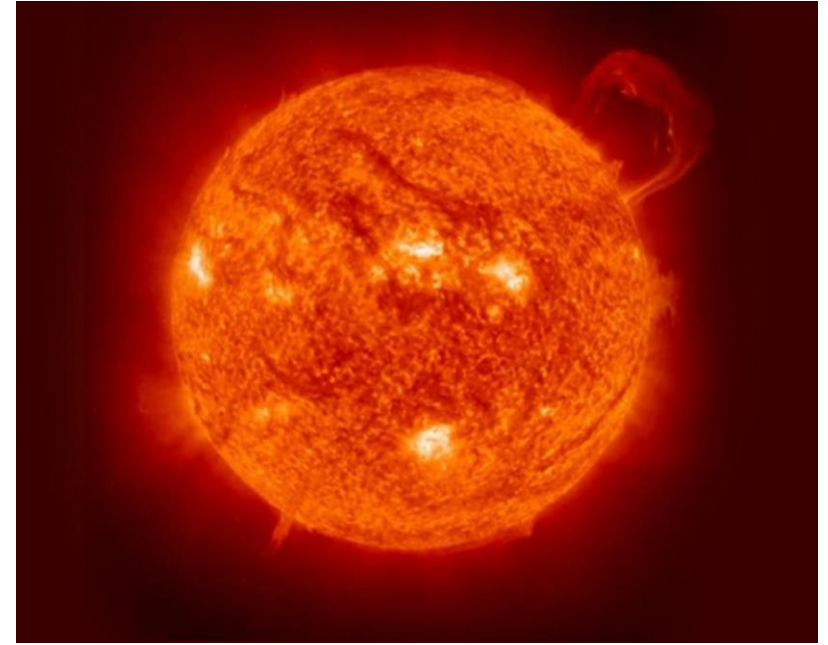

Plasma

occurrence on earth

Naturally: flash, solar wind, aurora

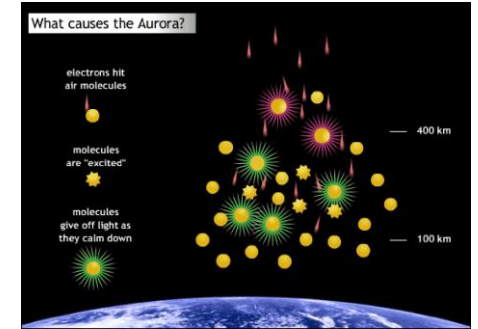
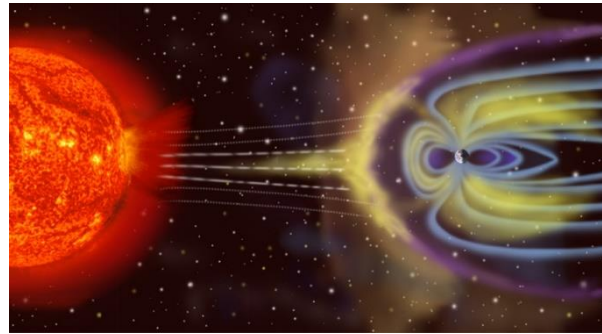

Artificially: light source - discharge lamp, laboratory use

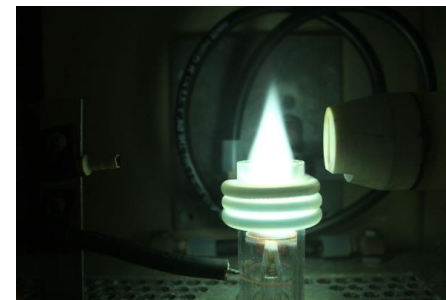

Inductively Coupled Plasma

ion source for mass spectrometry

Is a type of plasma source in which the energy is supplied by electric currents which are produced by electromagnetic induction, that is, by time-varying magnetic fields.

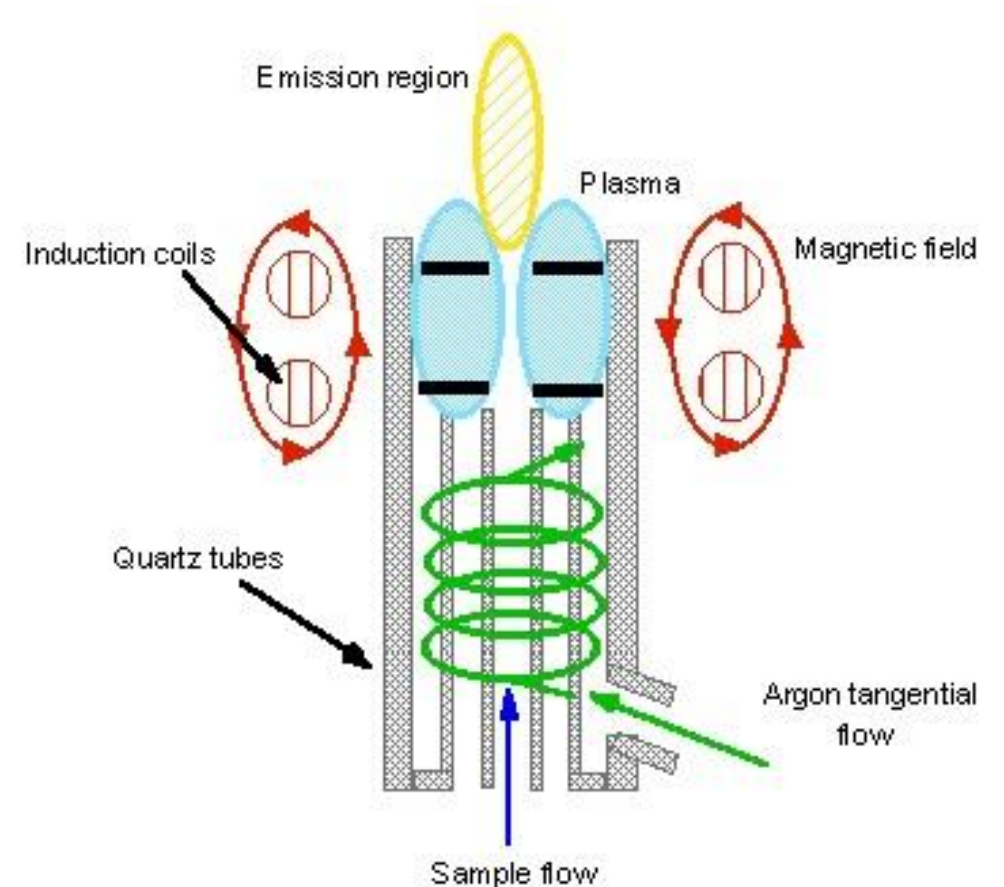
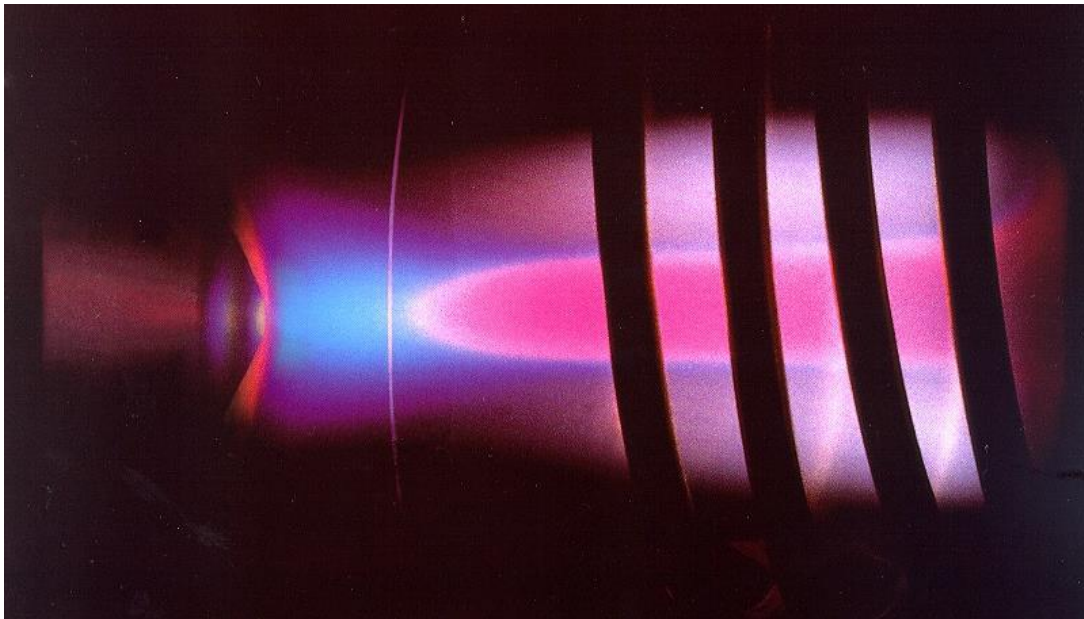

Inductively Coupled Plasma

ion source for mass spectrometry

In ICP-MS, a plasma or gas consisting of ions, electrons and neutral particles, is formed from Argon gas, which is then utilized to atomize and ionize the elements in the sample matrix. These resulting ions are then passed through a series of cones into a high vacuum mass analyzer where the isotopes of the elements are identified by their mass-to-charge ratio. The intensity of a specific peak in the mass spectrum is proportional to the amount of the elemental isotope from the original sample.

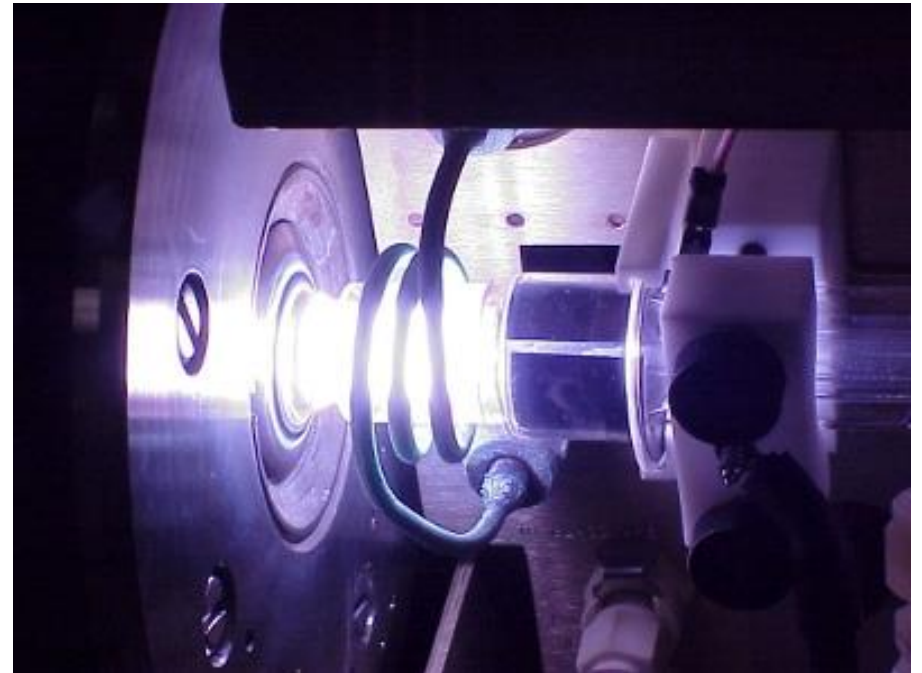

Inductively Coupled Plasma

ion source for mass spectrometry

Energy of processes in plasma maintained by high-frequency electromagnetic field, it is not burning = oxidation processes (therefore it is not possible to call plasma torch ICP burner), it is primarily the kinetic energy of electrons and Ar ions accelerated by hf field



Inductively Coupled Plasma

plasma torch

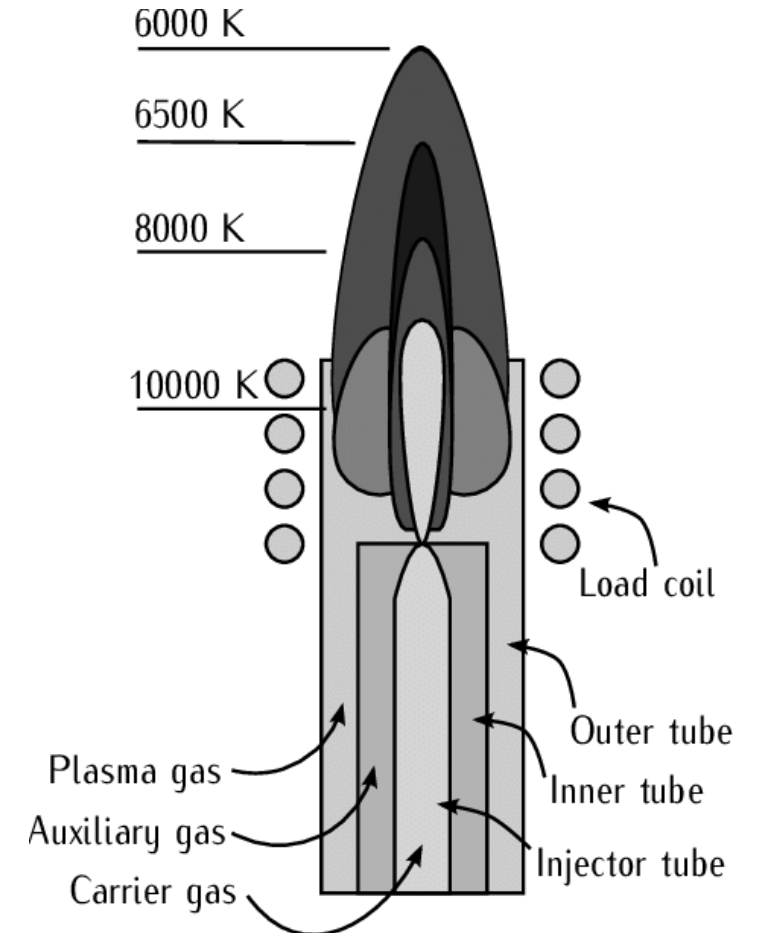
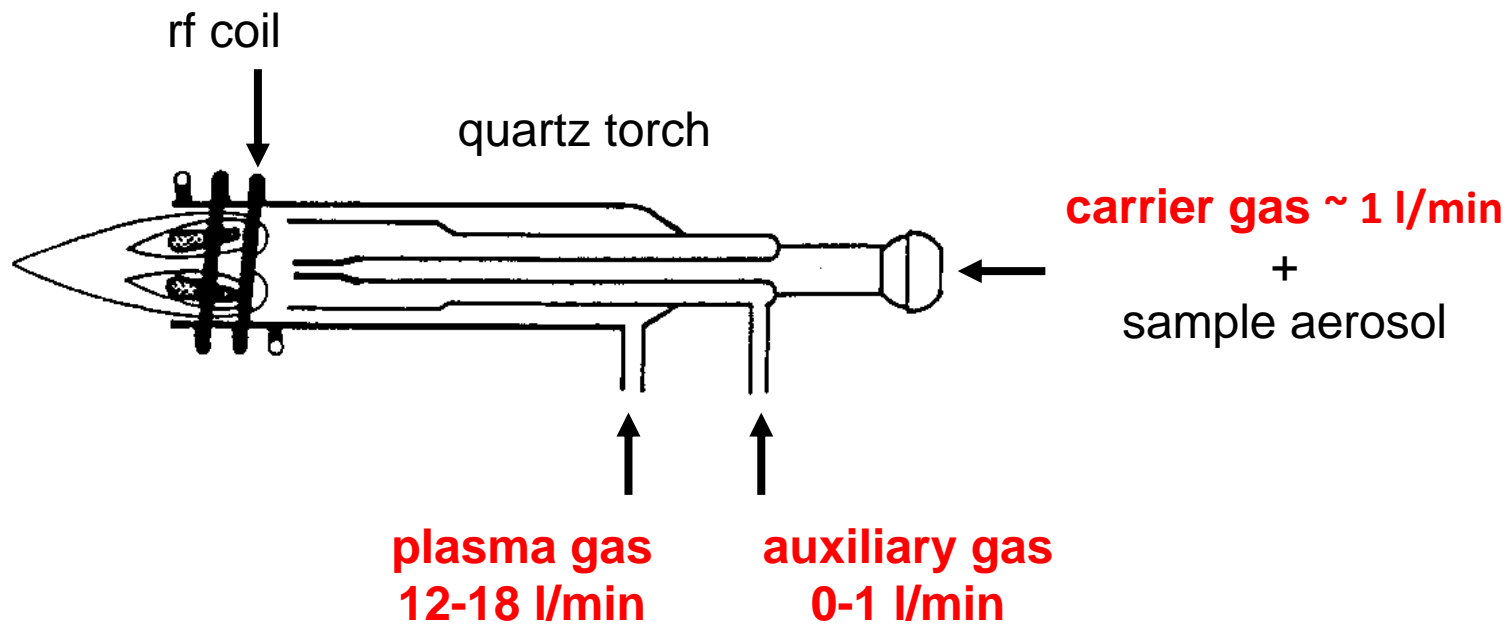

Inductively Coupled Plasma

plasma torch

The plasma torch is designed in such a manner that the sample is then injected directly into the heart of the plasma. The injected sample consists of a fine aerosol, which can be derived from, but not limited to, nebulized liquids and ablated solids. As this aerosol sample passes through the plasma, it collides with free electrons, argon cations, and neutral argon atoms, causing any molecules initially present in the aerosol to be quickly and completely broken down into charged atoms. Some of these charged atoms will recombine with other species in the plasma to create both stable and meta-stable molecular species, which will then be transmitted into the mass analyzer along with the charged atoms. At this point, a special set of metal cones and ion-focusing elements are used to extract the charged atoms from the plasma into the mass analyzer.

Inductively Coupled Plasma

plasma torch

- Presence of charged particles
energy supply via induction
- Annular plasma (cf. Donut shape!)
Plasma is punctured by central gas flow
- Rf frequency
27.12 MHz quartz-controlled oscillator
(Free-running generator 40.68 MHz)

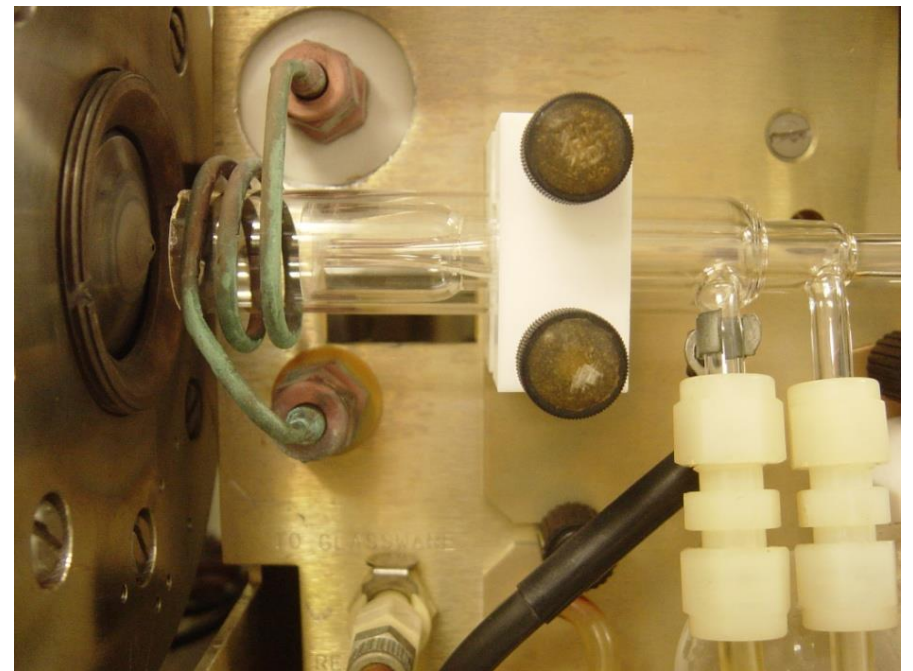
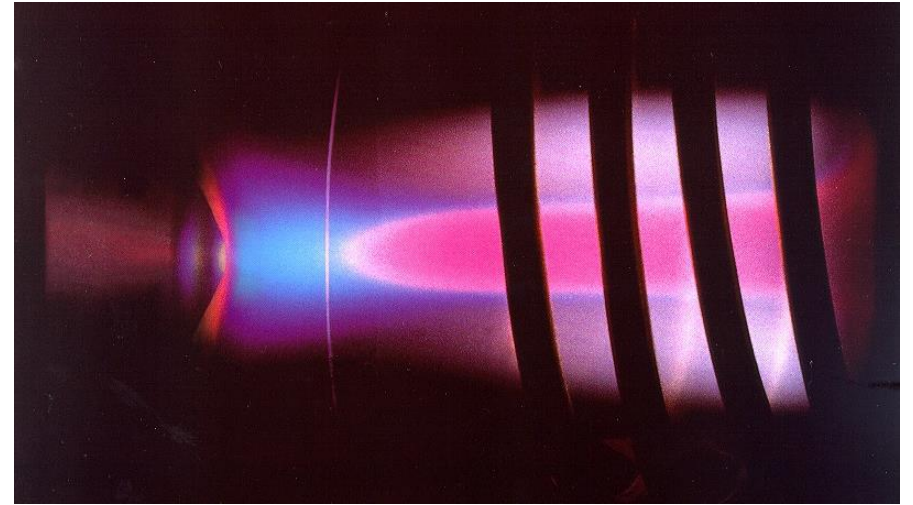
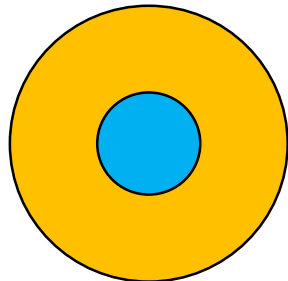

Inductively Coupled Plasma

plasma torch

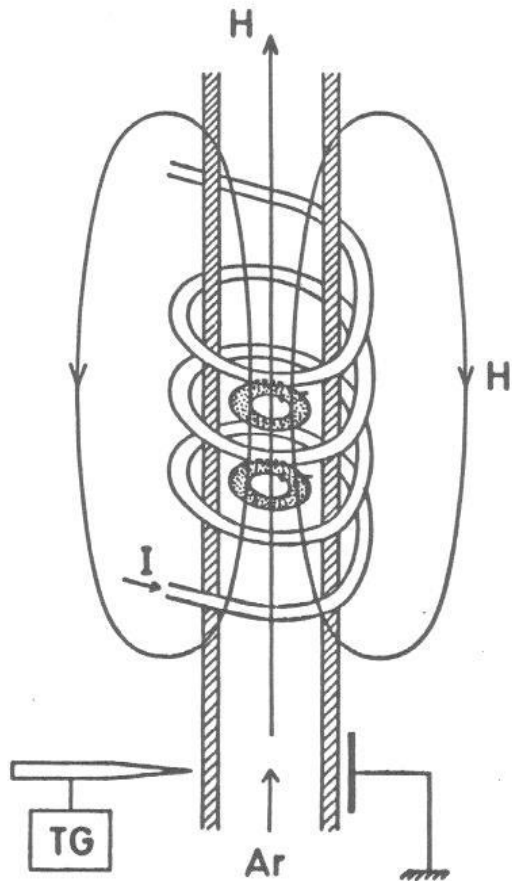

- rf current through coil
- time-dependent magnetic field
- electrons accelerated in circular paths
- collision with Ar atoms: ionization
- seed electrons: spark (Tesla-generator)

analyte ionization

electron impact $e^- + M \rightarrow M^+ + 2 e^-$

Penning ionization $Ar^* + M \rightarrow M^+ + e^-$

charge transfer $Ar^+ + M \rightarrow M^{+*} \pm \Delta E$

Inductively Coupled Plasma

formation of ICP

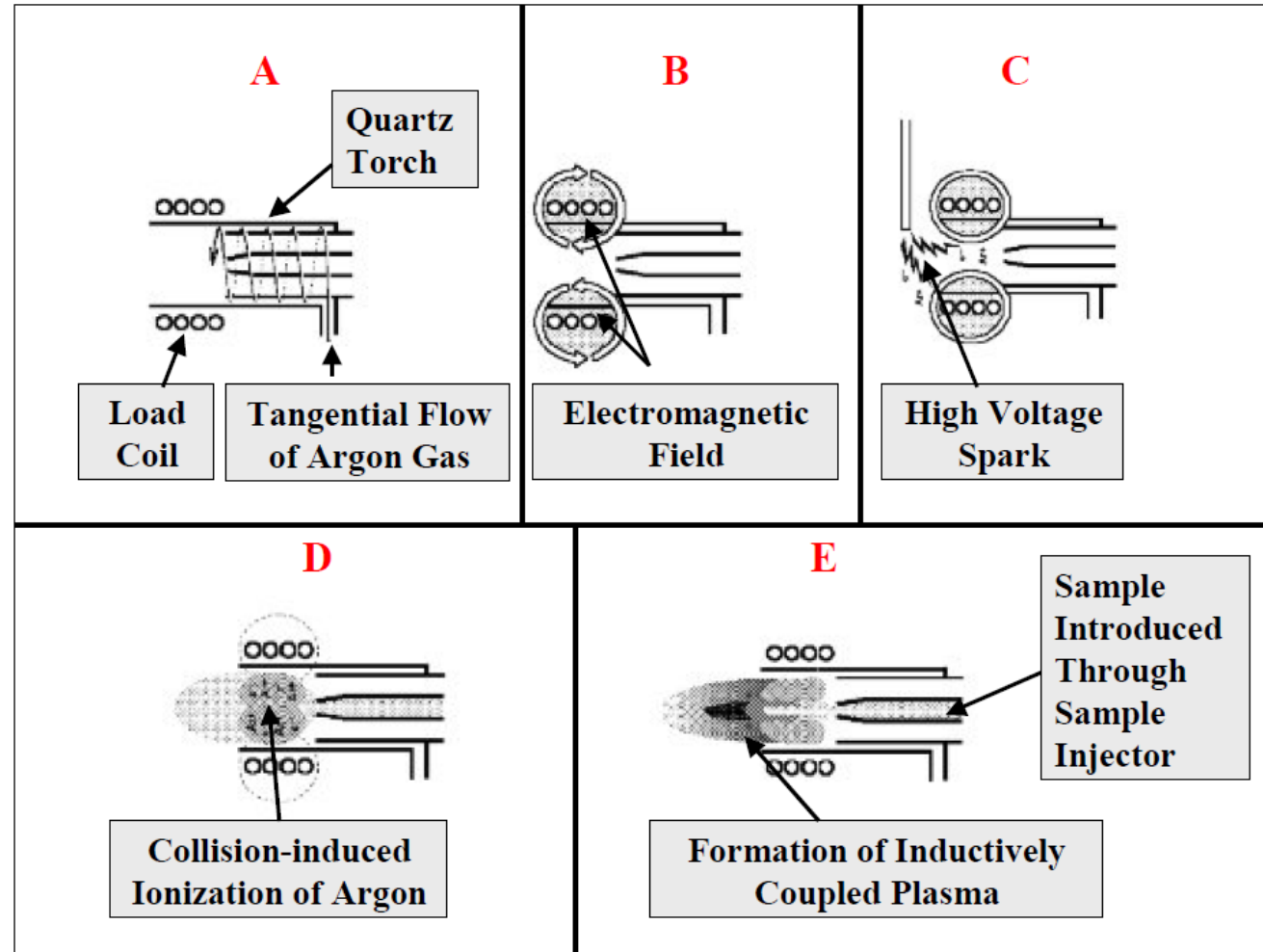

Inductively Coupled Plasma

analyte ionization

Residence time of analyte in ICP: ~ ms

- desolvation
- dissociation
- atomization
- excitation
- ionization

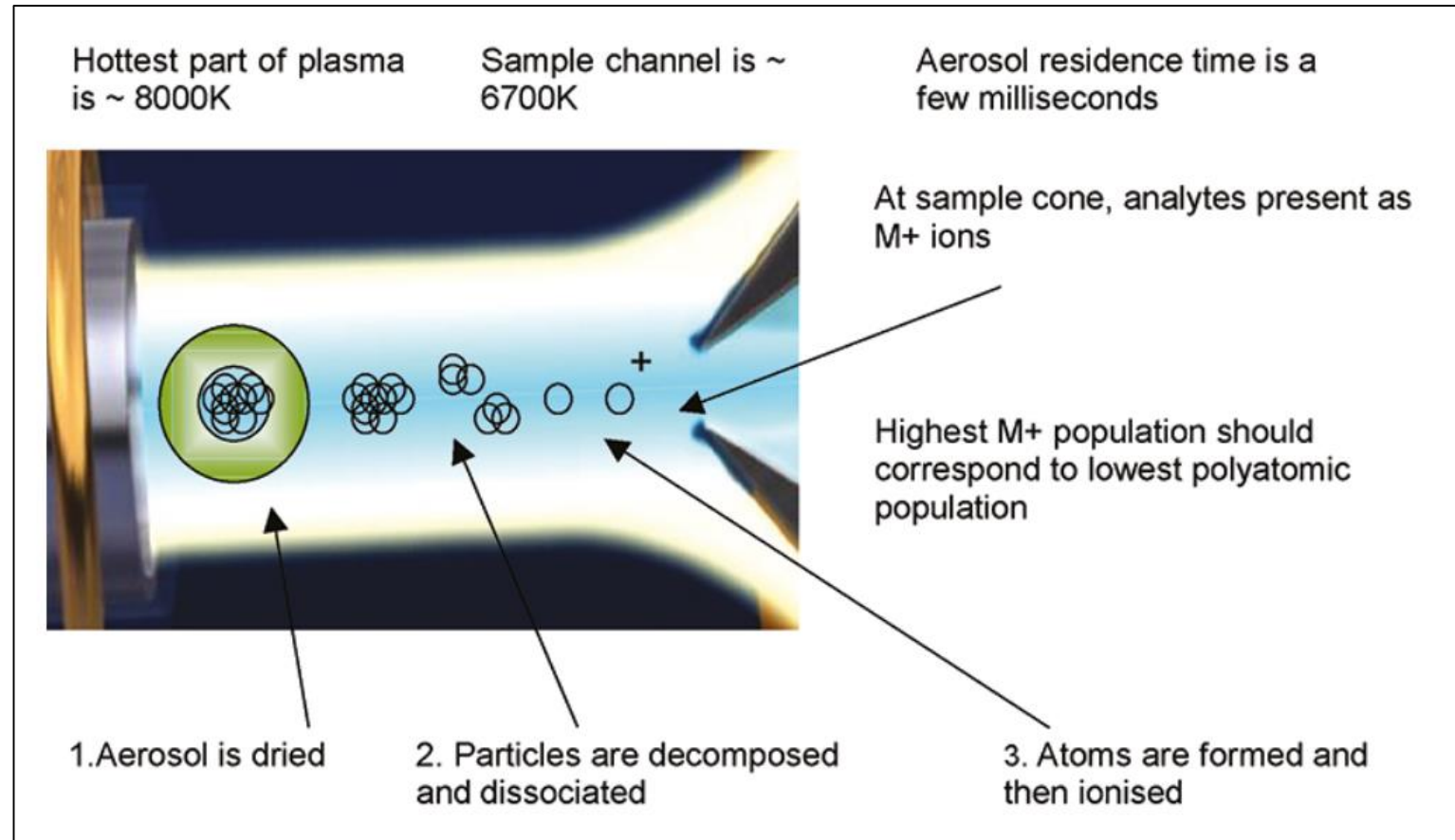

Inductively Coupled Plasma

analyte ionization

Energy achieved by the Ar ICP is sufficient to cause the majority of sample atoms passing through it to exceed their first, but not second, ionization potentials. The significance of this is two-fold: (1) elements from most of the periodic table will be ionized to a +1 state, and (2) because the ions generated will principally differ by mass, not charge, they can be focused and separated on the basis of their inertial masses within an electrostatic field.

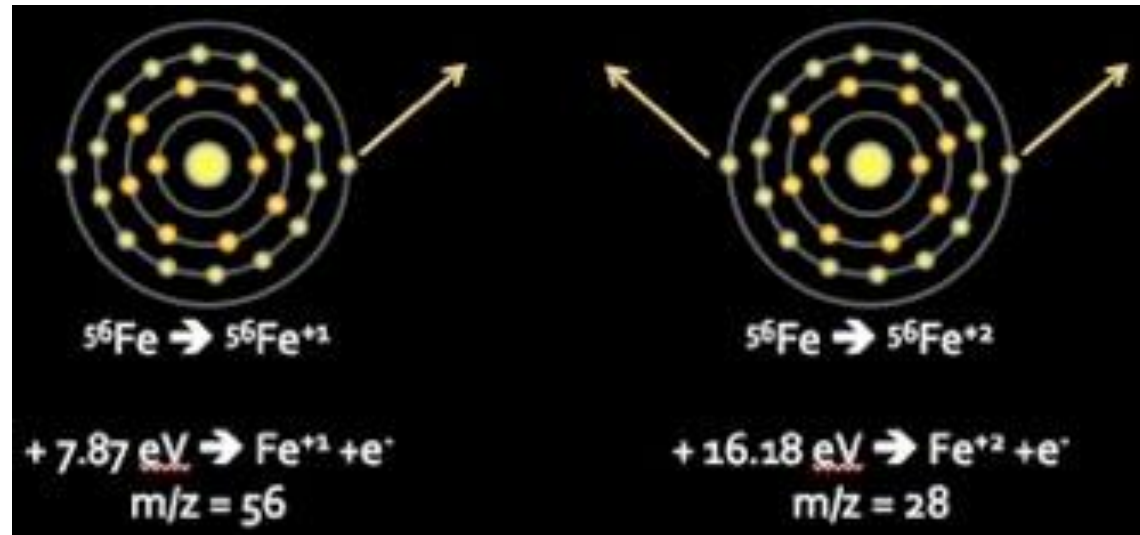

Energetics of progressive ionization of ^{56}Fe . The Ar plasma temperature is sufficient to convert the vast majority of iron atoms into singly charged species (remove a single outer shell electron), with negligible production of doubly charged species (remove two outer shell electrons).

Inductively Coupled Plasma

analyte ionization

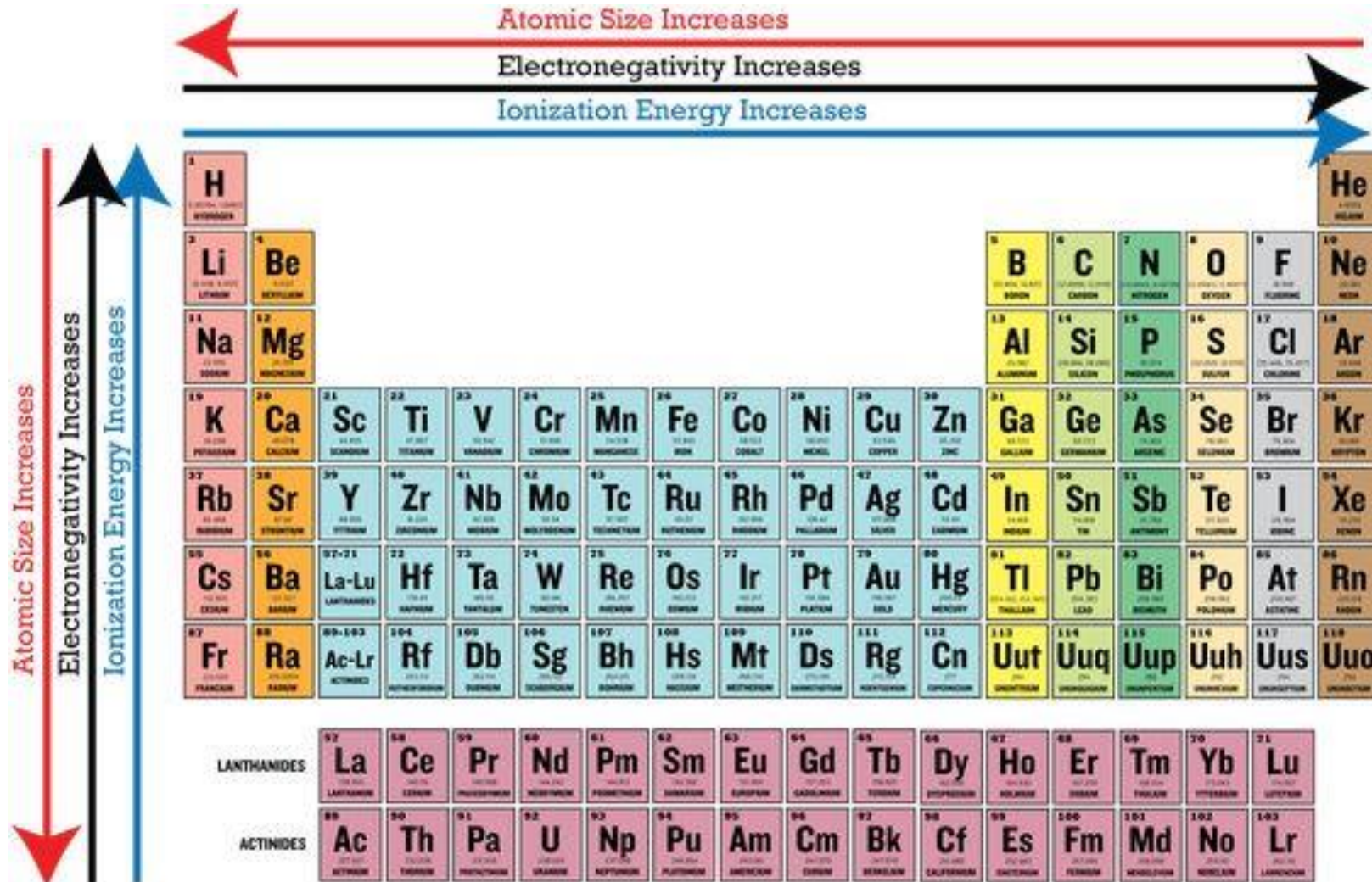

Inductively Coupled Plasma

analyte ionization

Ionization energy: the energy required to remove an electron from a neutral atom.

Electronegativity: the ability of an atom in a molecule to draw bonding electrons to itself. Higher values of electronegativity have those elements that reach the electronic configuration of the following noble gas by forming an anion. Such elements are referred to as electronegative elements.

Atomic size: the atomic radius increases with each filled shell of electrons. For any column in the periodic table, the size increases down a column. The attraction between the positively charged protons and the negatively charged electrons causes a contraction, or a decrease in size as the number of protons increases. In any row, increasing the number of protons decreases the size of the atom even though the number of protons always equals the number of electrons.

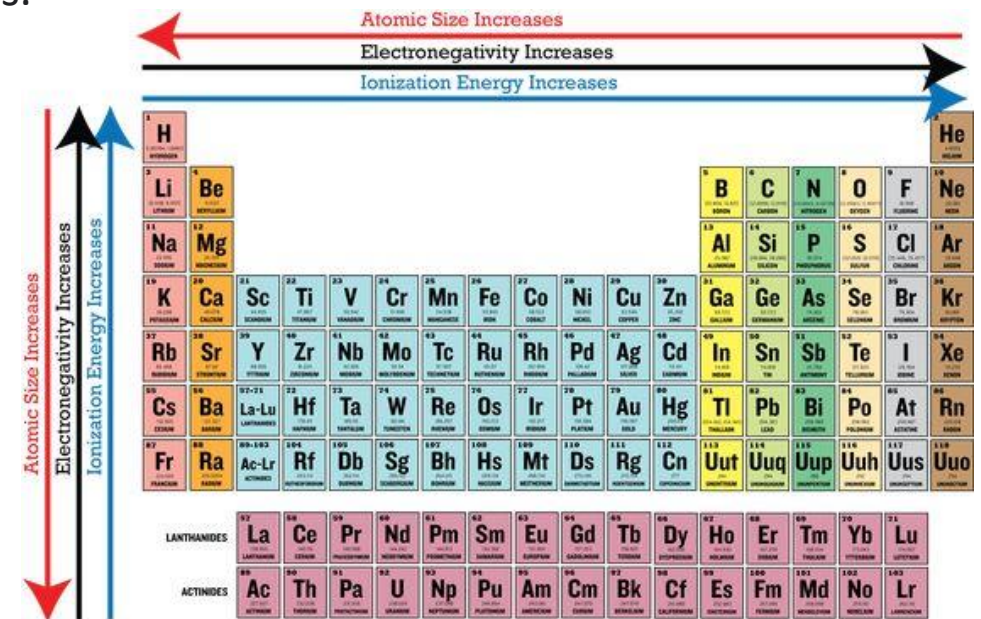

Inductively Coupled Plasma

analyte ionization

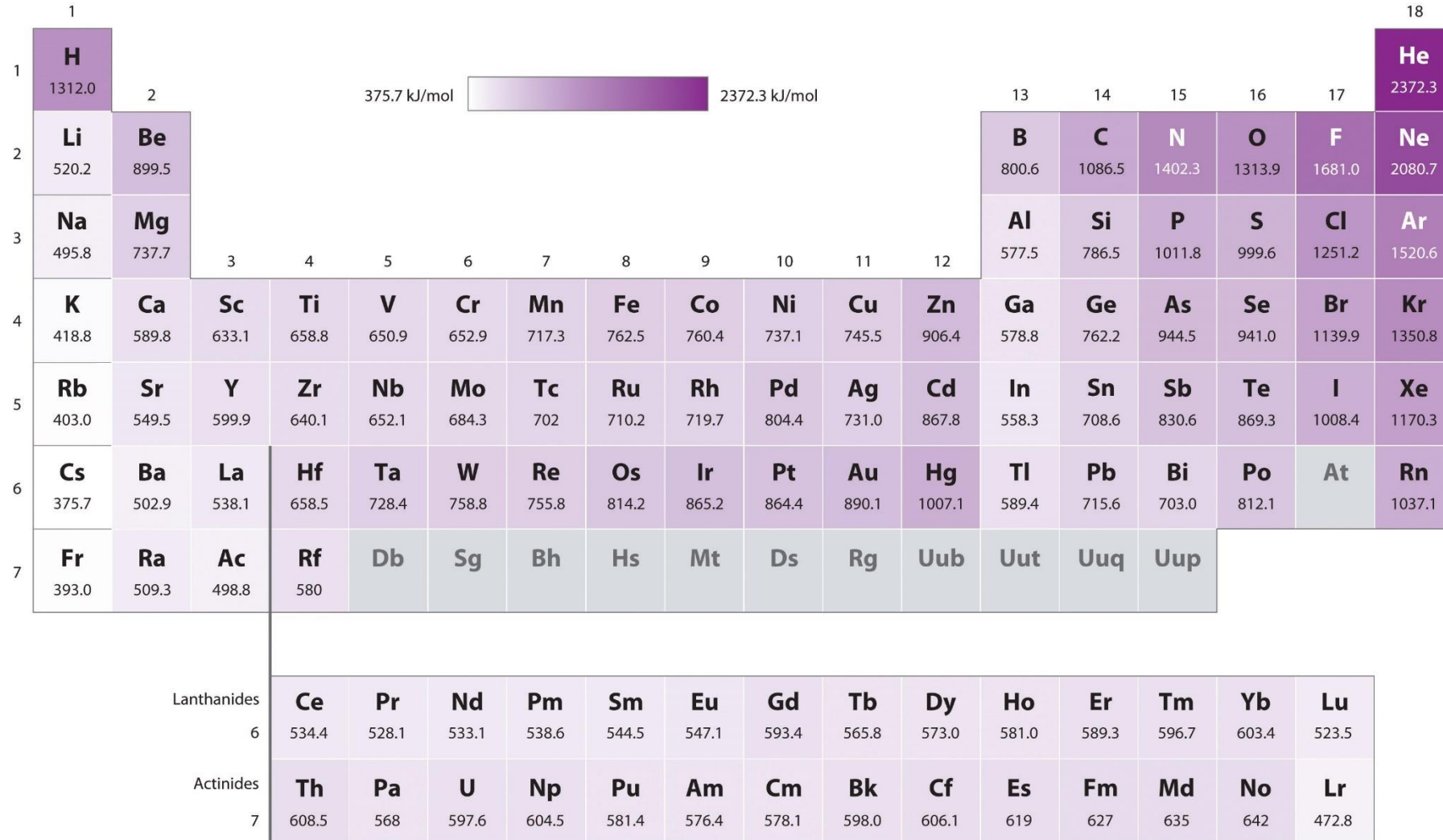

Inductively Coupled Plasma

analyte ionization

Ionization energy (kJ/mol) SI ~ Ionization potential (eV) non-SI (It corresponds to the kinetic energy obtained by an electron accelerated in a vacuum with a voltage of one volt)

$$1 \text{ eV} = 1.602\,176\,634 \times 10^{-19} \text{ J}$$

Ar: 1520.6 kJ/mol vs. 15.76 eV

Inductively Coupled Plasma

analyte ionization

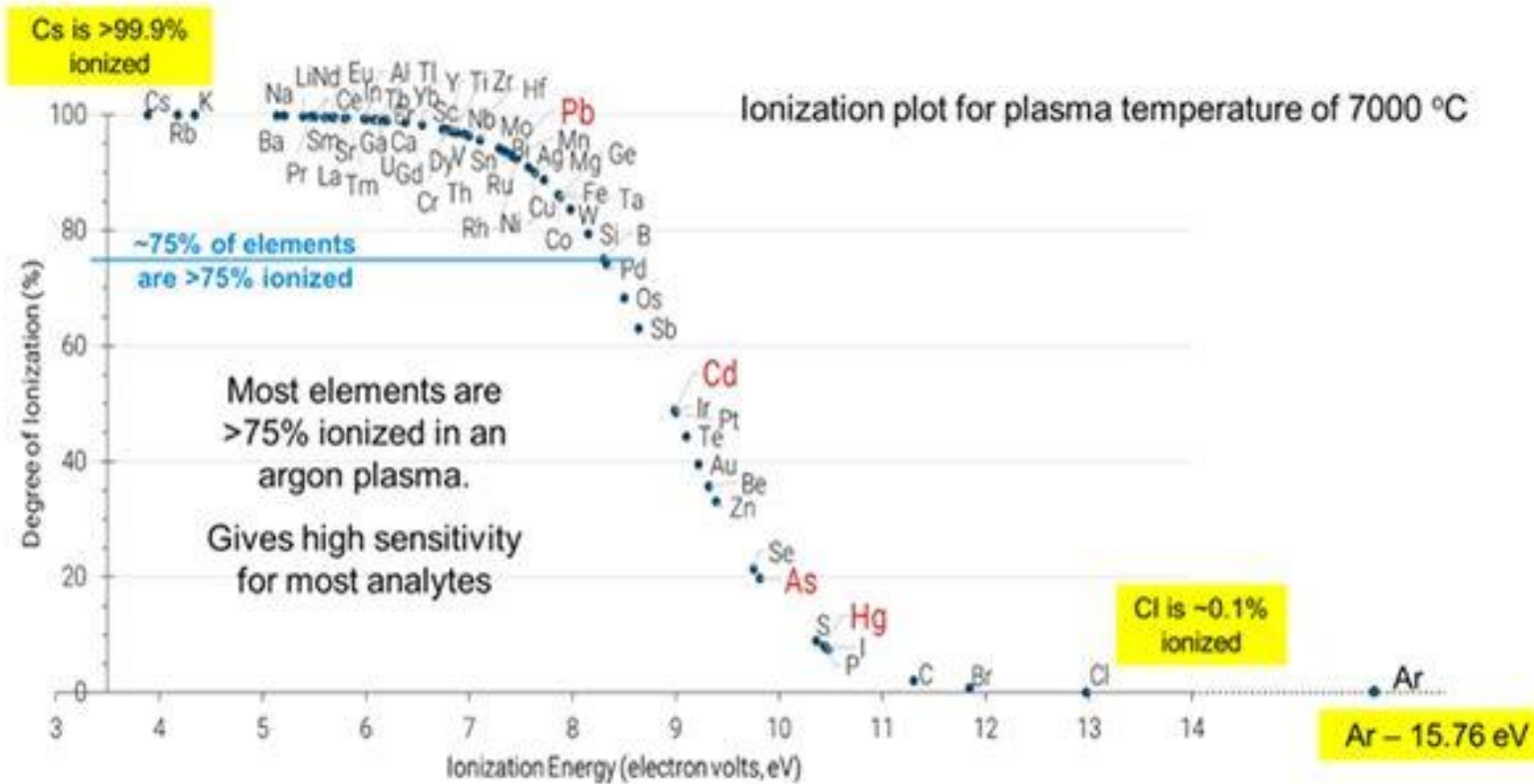

Degree of ionization vs. Ionization energy for singly charged ions in ICP.

Inductively Coupled Plasma

analyte ionization

It is important to realize that although most elements are substantially ionized in the high temperature Ar plasma (Houk 1986; Douglas and Tanner, 1998), some elements having first ionization potentials approaching or exceeding that of Ar (15.76 eV) can have much lower ionization efficiencies. Quantitative ion measurements require both consistent +1 ionization and adequate sensitivity. Arsenic (9.81 eV), selenium (9.75 eV), and phosphorous (10.49 eV), for example, have fairly low first ionization efficiencies on the order of 52, 33 and 33%, respectively, which are still sufficient for robust quantitative determinations. By comparison, sulfur (10.36 eV) and fluorine (17.42 eV) have respective first ionization efficiencies of only 14% and 0.00091%, for which quantitative determinations are impractical or impossible. With well-optimized plasma conditions, doubly charged ions for most elements occur in negligible amounts, with worst case maxima typically on the order of 1-3% for elements having lowest second ionization potentials (e.g., Ba²⁺).

Inductively Coupled Plasma

analyte ionization



Elemental first ionization efficiencies (as percents) calculated for 7500°K and electron density of 1 x 10¹⁵/cm³.

Inductively Coupled Plasma

analyte ionization

Ion population as a function of plasma temperature and ionization potential, calculated using Saha equation.

$$K_M = \frac{n_i n_e}{n_a} = \left(\frac{2\pi m_e k T_{\text{ion}}}{h^3} \right)^{3/2} 2 \frac{Z_i}{Z_a} \exp\left(-\frac{E_i}{k T_{\text{ion}}} \right)$$

Ed McCurdy and Don Potter, Spectroscopy Europe, 13/3, 2001

Element	Ip (eV)	Plasma temperature			
		5000 K	6000 K	7000 K	8000 K
Cs	3.89	99.4%	99.9%	100.0%	100.0%
Na	5.14	90.0%	98.9%	99.8%	99.9%
Ba	5.21	88.4%	98.7%	99.8%	99.9%
Li	5.39	83.4%	98.2%	99.7%	99.9%
Sr	5.69	71.5%	96.8%	99.5%	99.9%
Al	5.98	56.2%	94.5%	99.1%	99.8%
Pb	7.42	4.3%	51.2%	91.1%	98.3%
Mg	7.64	2.6%	40.7%	87.7%	97.7%
Co	7.86	1.6%	31.0%	83.2%	96.9%
Sb	8.64	0.3%	9.0%	57.6%	90.9%
Cd	8.99	0.1%	4.8%	43.2%	85.7%
Be	9.32	0.1%	2.6%	30.6%	78.8%
Se	9.75	0.0%	1.1%	17.8%	66.6%
As	9.81	0.0%	1.0%	16.4%	64.6%
Hg	10.43	0.0%	0.3%	6.5%	42.6%

