

RNA DEGRADATION AND QUALITY CONTROL

RNA metabolism 21st November 2023



LECTURE CONTENTS

RNA degradation

- general principles
- RNA degradation machines

RNA surveillance

- noncoding RNAs
- coding RNAs (mRNAs)

(m)RNA Turnover: Why Should We Care?

1. Control of Gene Expression
2. Quality Control of RNA Biogenesis

RNA degradation in development

Some examples

Gene expression during preimplantation embryo development

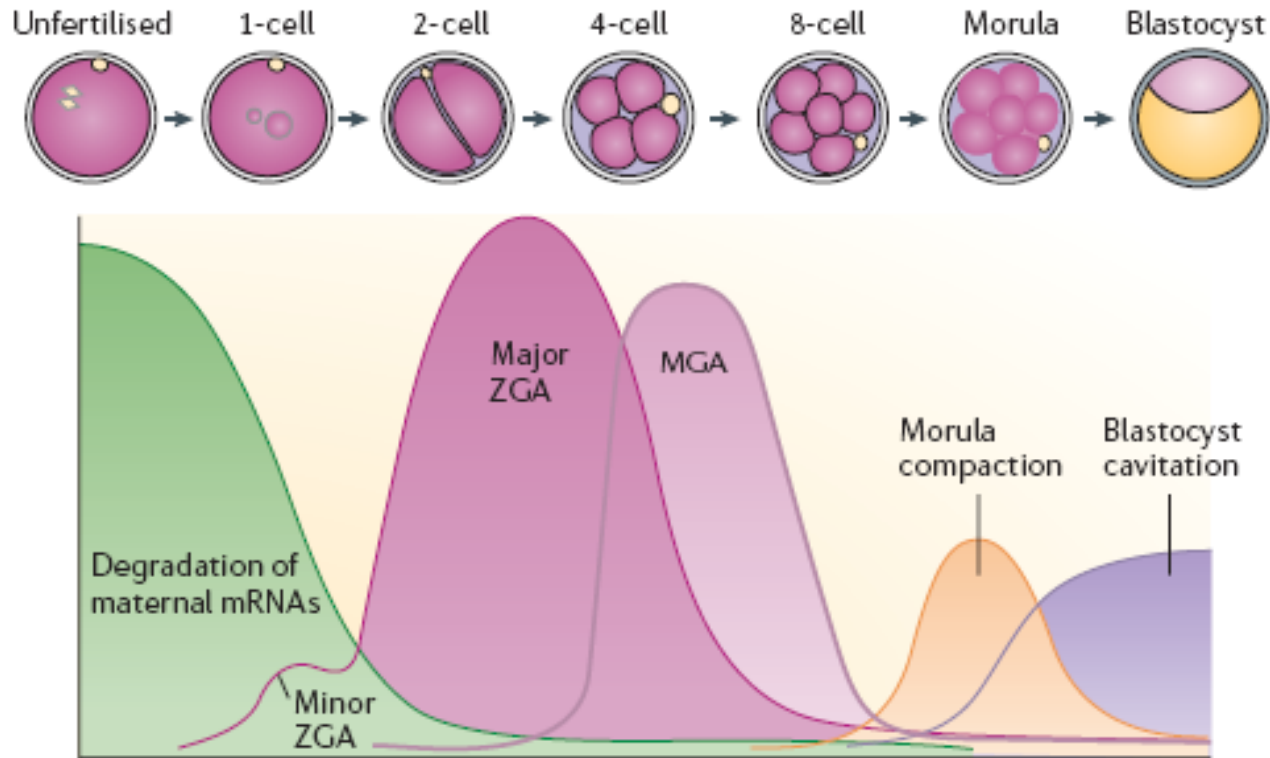

Wang et al. Nature Reviews Genetics 7, 185–199 (March 2006) | doi:10.1038/nrg1808

RNA metabolism 2023

All steps of mRNA production are controlled

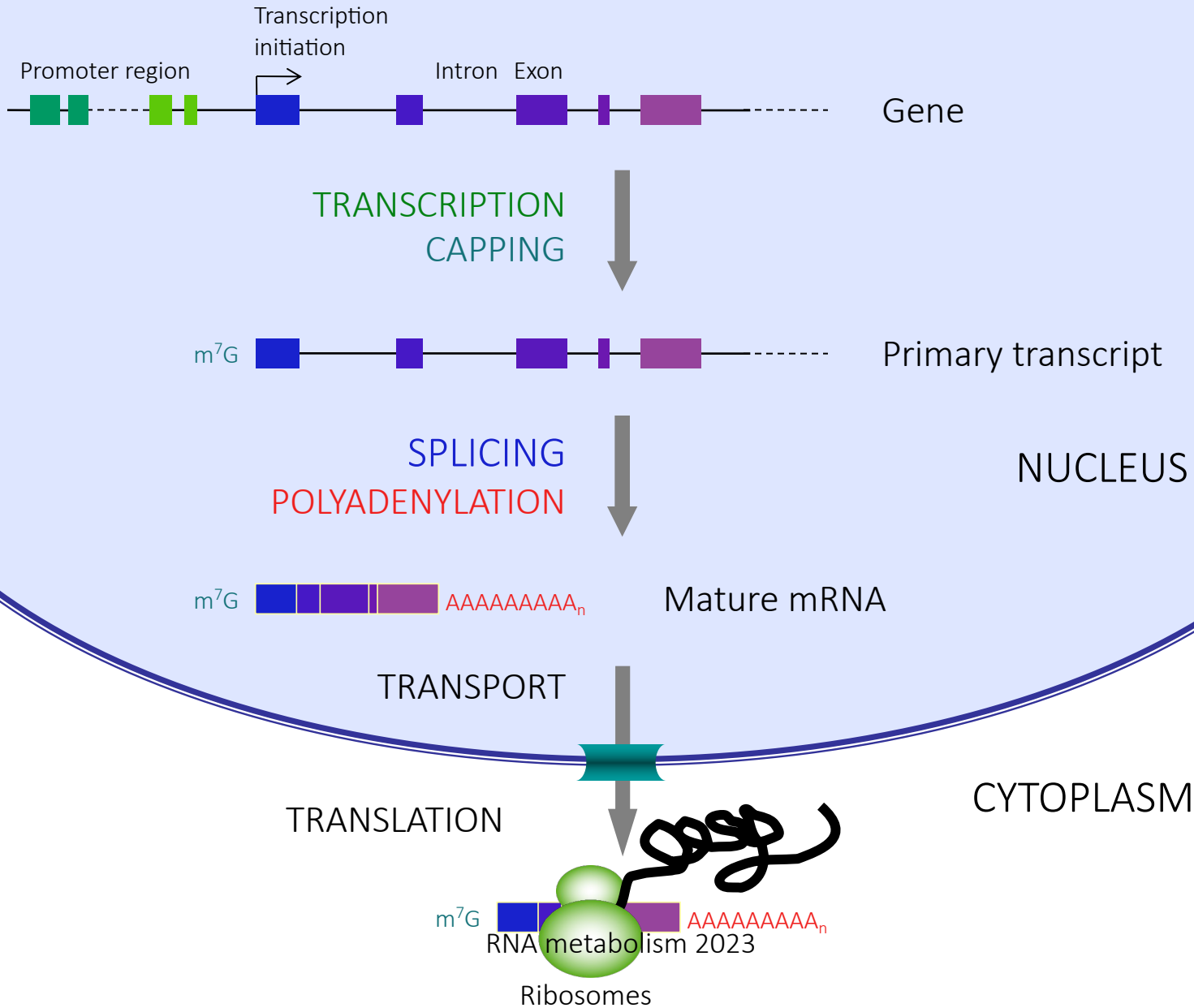

Ribosomal RNA maturation is one of the most complex RNA linked processes in the cell and must be tightly controlled.

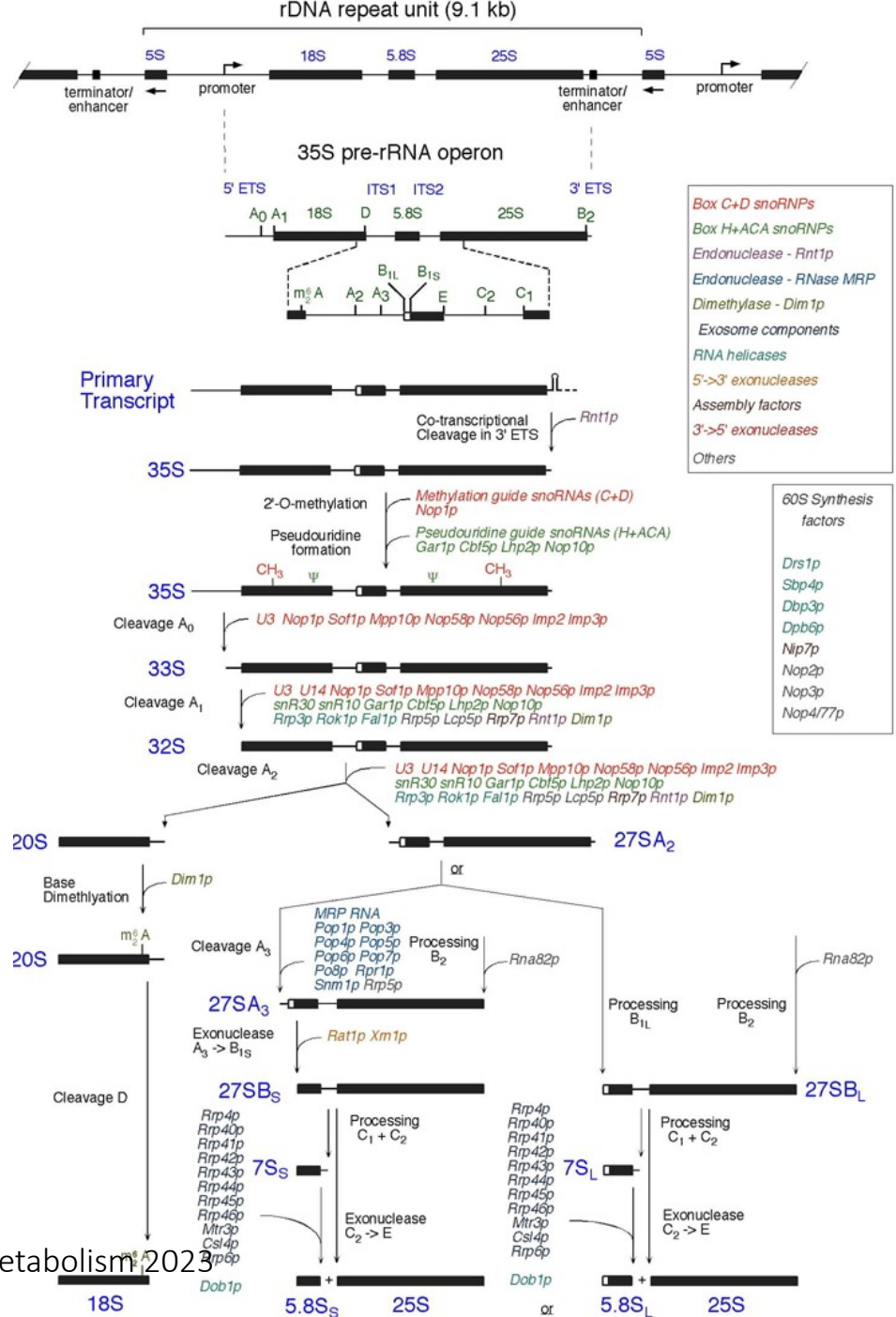

rRNA production is highly complex and energetically expensive

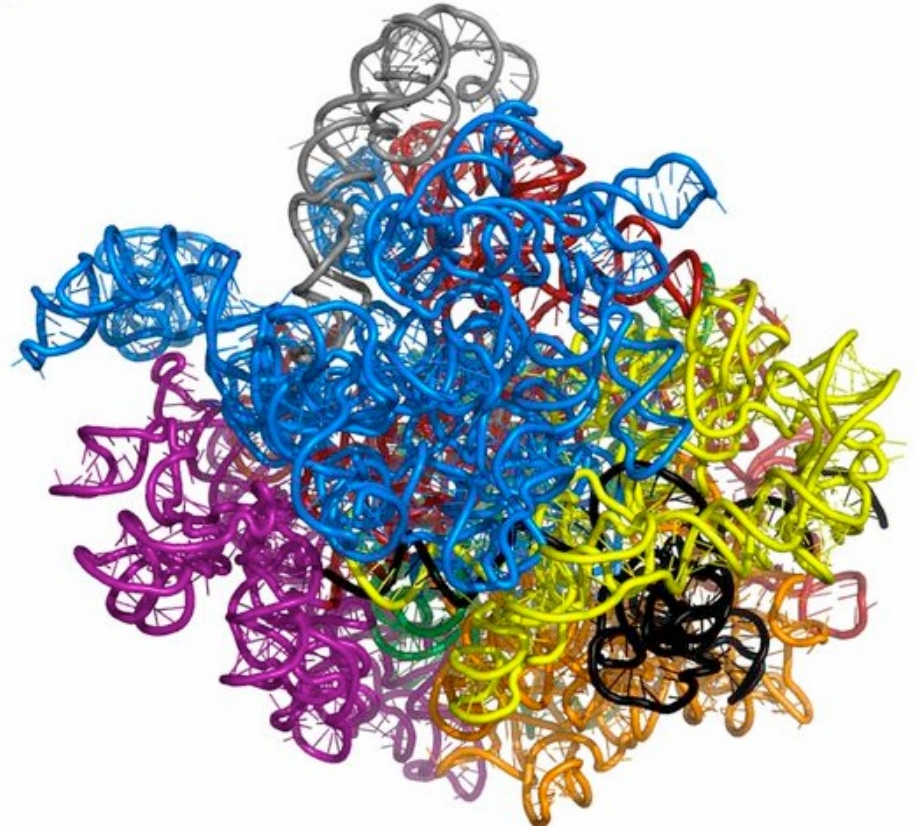
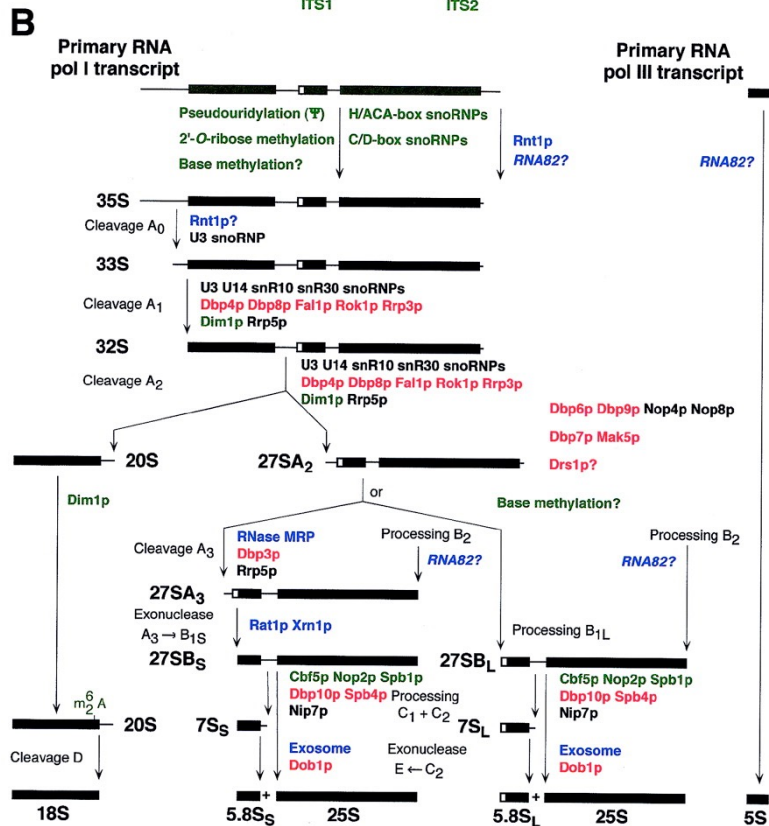
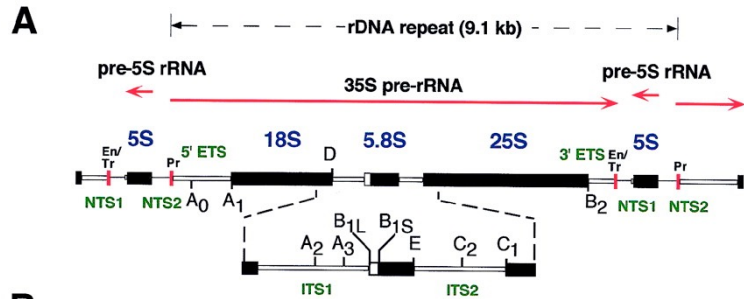

When the removal of decay products goes wrong



AVERAGE mRNA HALF LIFE

AVERAGE mRNA HALF LIFE

E. coli: 4 min (2-10 min)

Yeast: 22 min (4-40 min)

Humans: 10 hours (0.5-24 hours)

RNA degradation: → typical mRNAs in a somatic cell last from minutes to hours and this is a function of the balance between synthesis and degradation

mRNA stability and turnover

- The concentration of mRNA is a function of both the rate of mRNA synthesis and the rate of mRNA degradation
- The stability of mRNA also determines how rapidly synthesis of the encoded protein can be shut down → e.g. for a stable mRNA, protein synthesis can persist long after transcription of the gene is repressed → mRNA half life of most multicellular eukaryotic cells is many hours (compared to just a few minutes for bacteria)
- Some proteins in eukaryotic cells are required for very short periods of time and are expressed in bursts (e.g. many signaling molecules like cytokines or cell cycle regulated transcription factors, such as c-fos)
- Regulating the stability of mRNA is one way of ensuring that proteins are present for only short bursts or for longer periods of time, as is needed

RNA degradation mechanisms

RNA is prone to nucleolysis

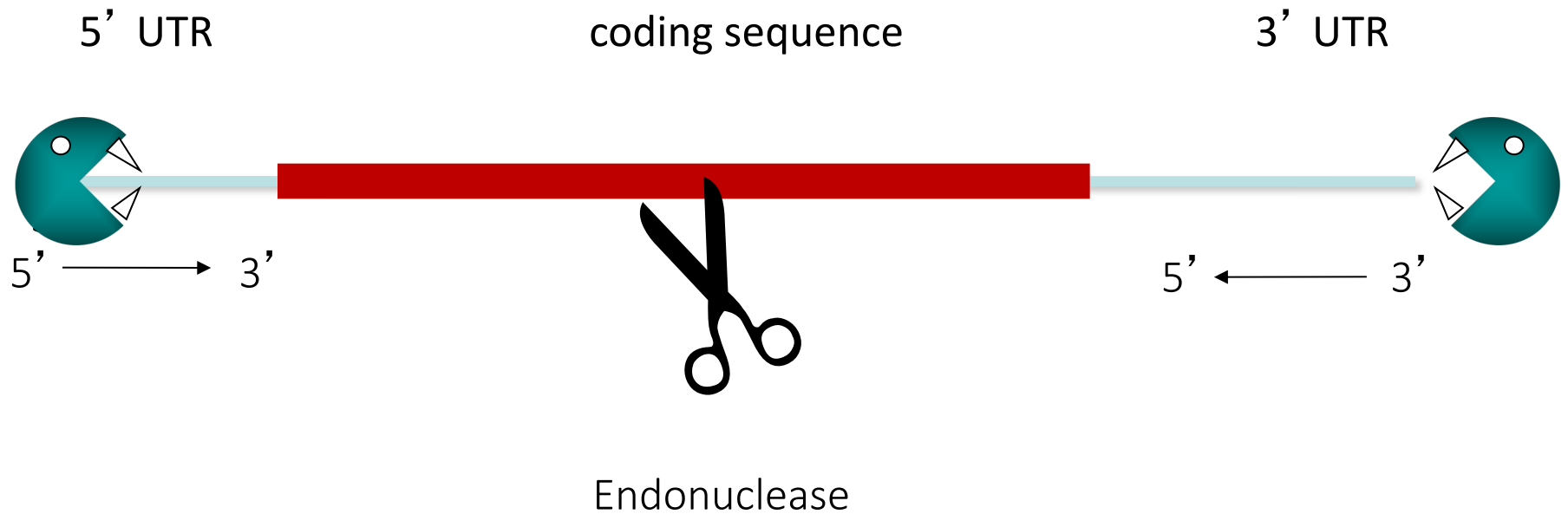

RNA degradation by nucleases

RNA ENDONUCLEASE

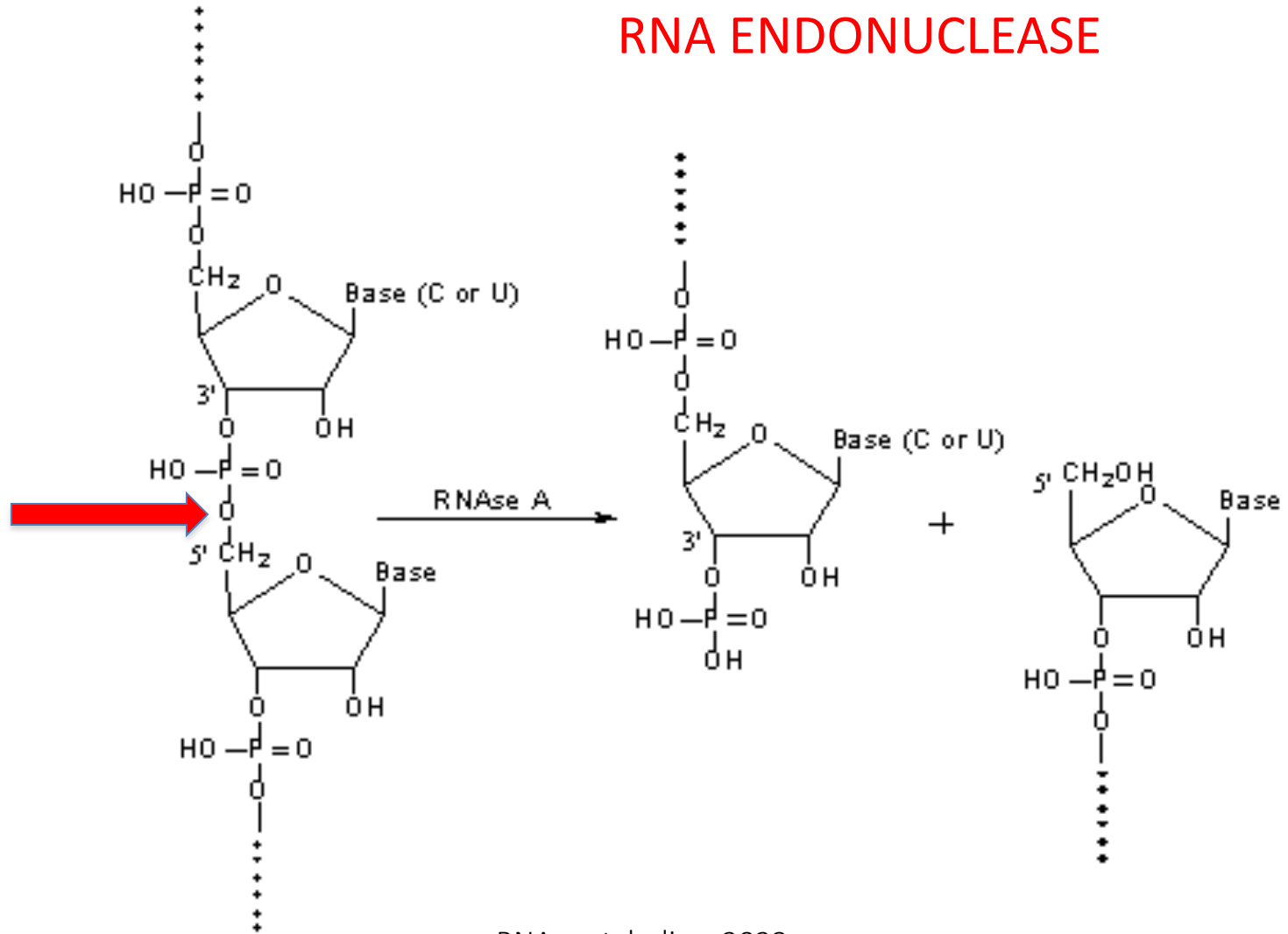

RNA degradation by nucleases

RNaseA

pankreatic endoribonuclease

Highly stable,

Heat resistant

Small – hard to remove

Monomer, 14 kDa

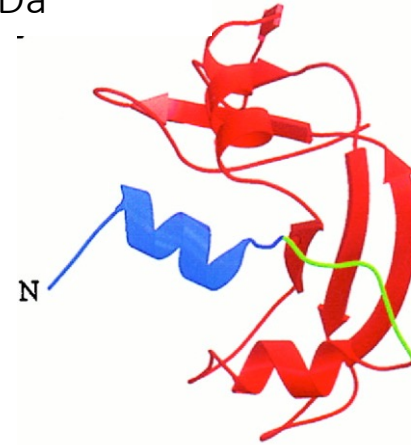

Dimer

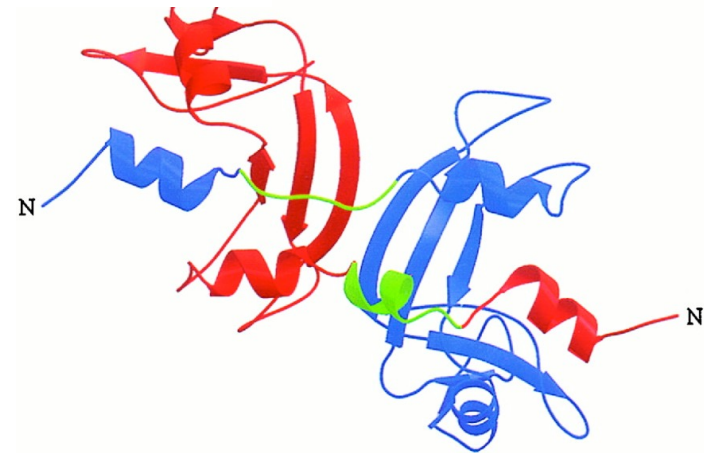

Liu et al., PNAS 1998

RNA degradation by nucleases

RNA ENDONUCLEASE

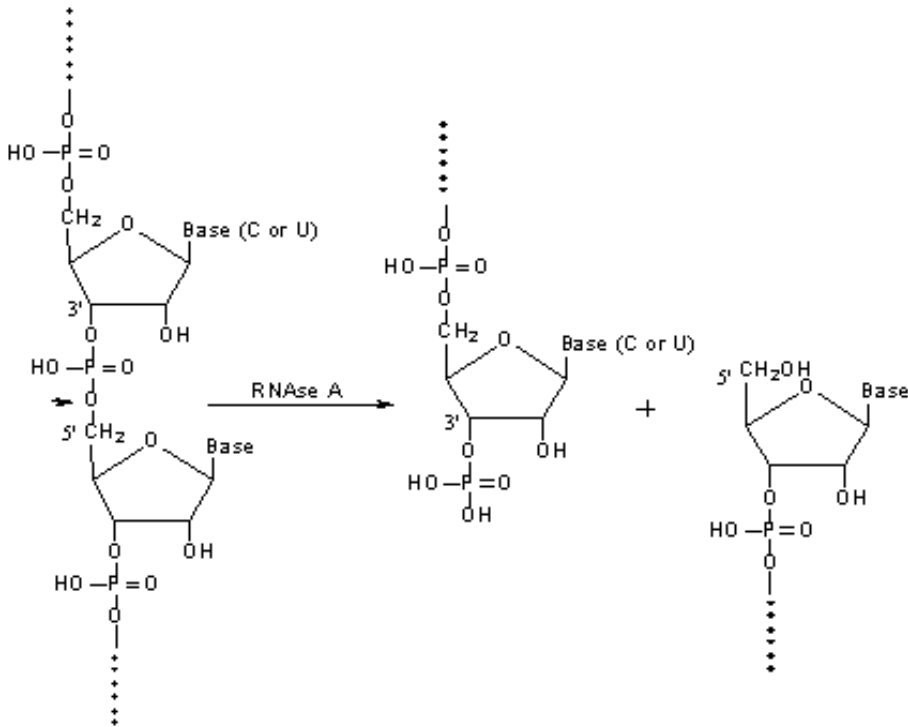

cleaves 3' of

RNase A

C,U

RNase T1

G

RNase T2

GACU

RNase U2

A in ssRNA

RNase I

GACU in ssRNA

RNase III

GACU in dsRNA

RNase H

RNA:DNA hybrid

(often used to remove specific parts of RNA)

RNAse protection assay

A

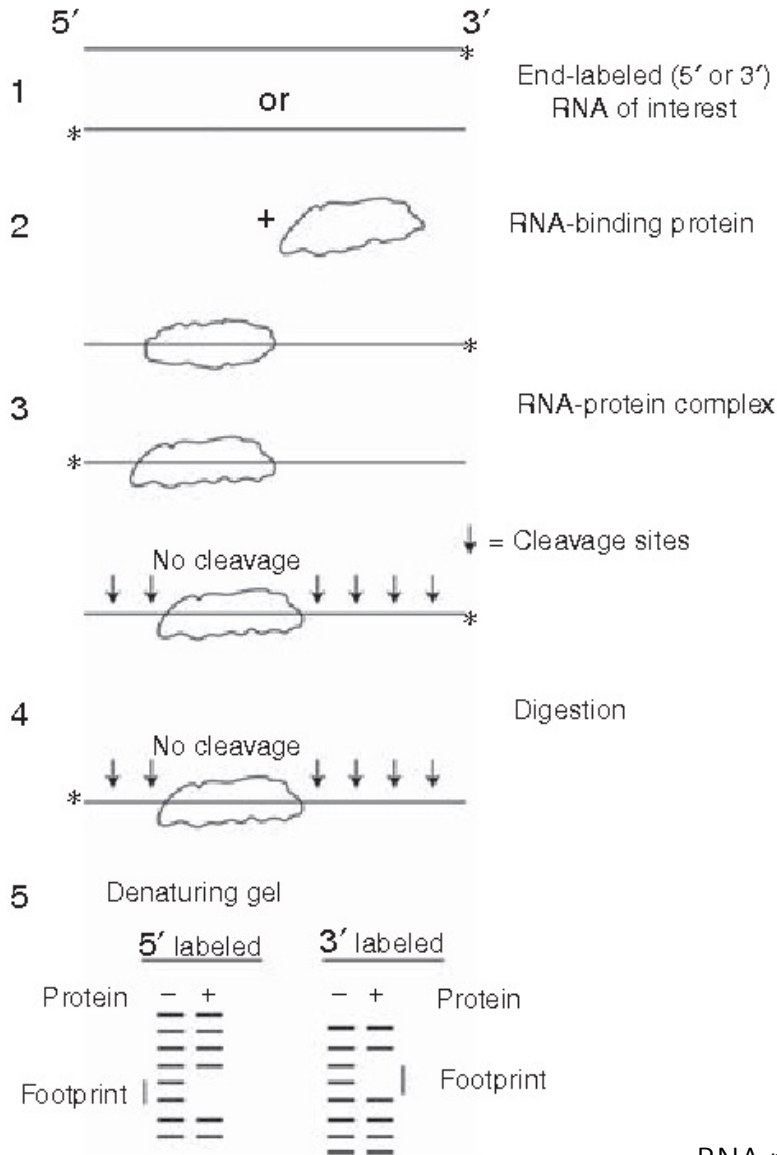

B

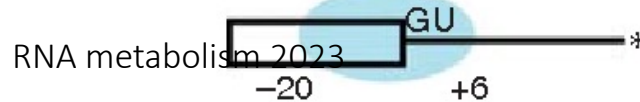
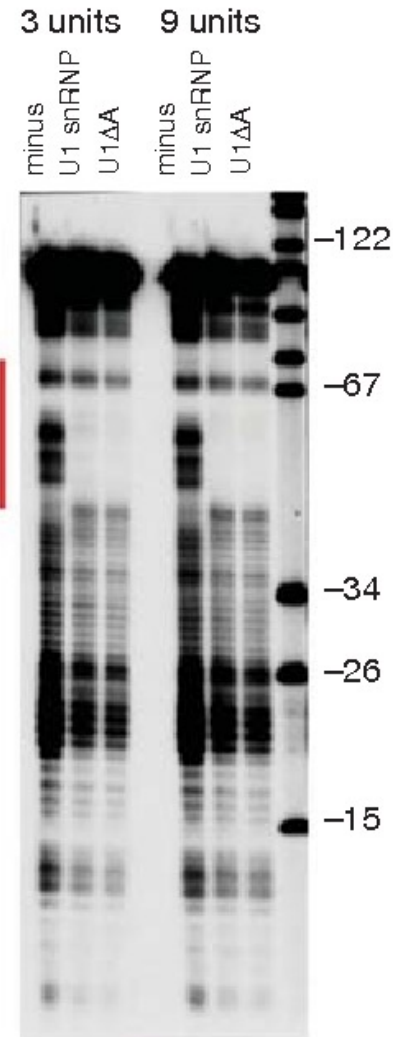

Ribosome footprinting analysis

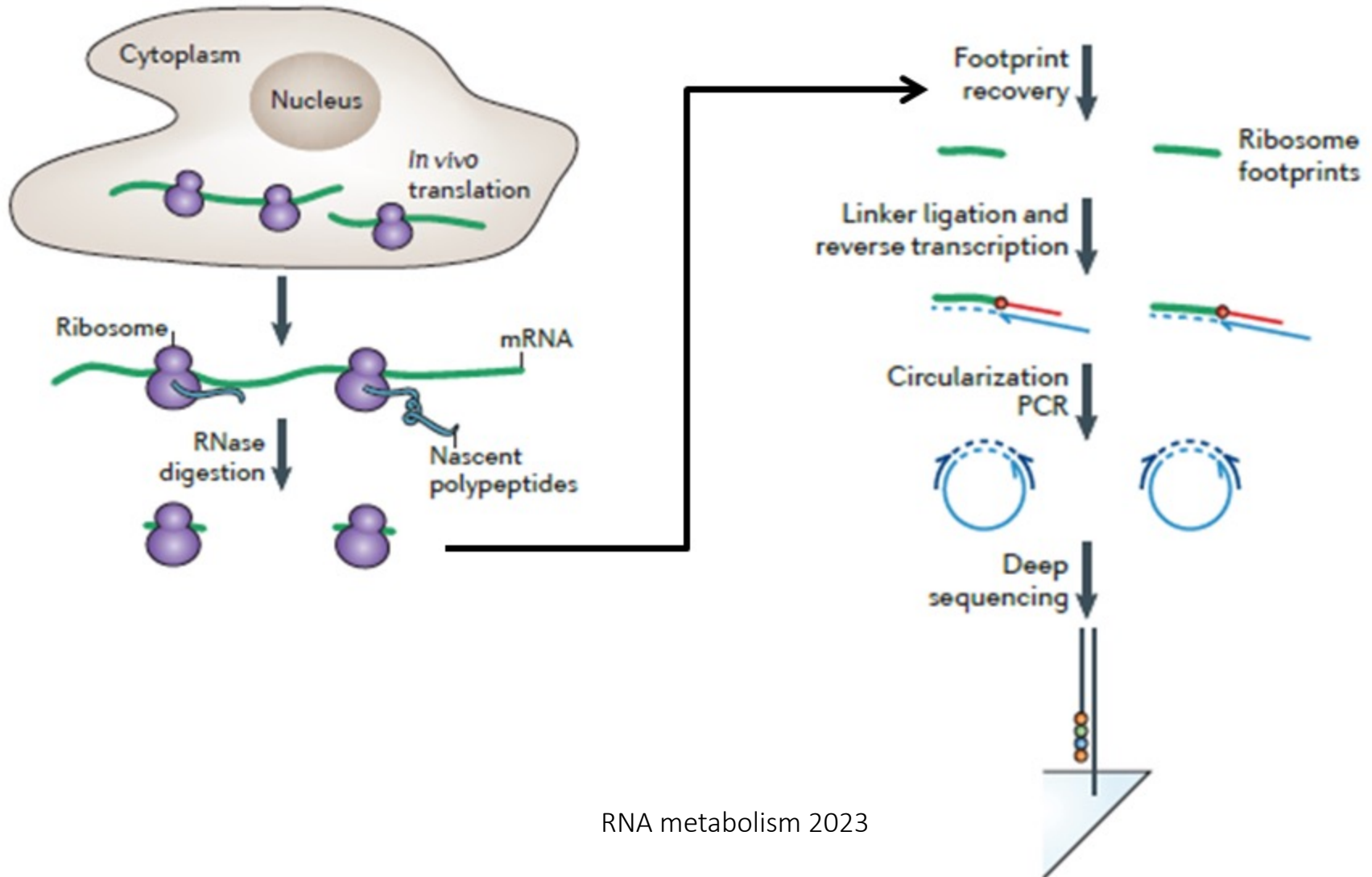

3' to 5' RNA exonuclease

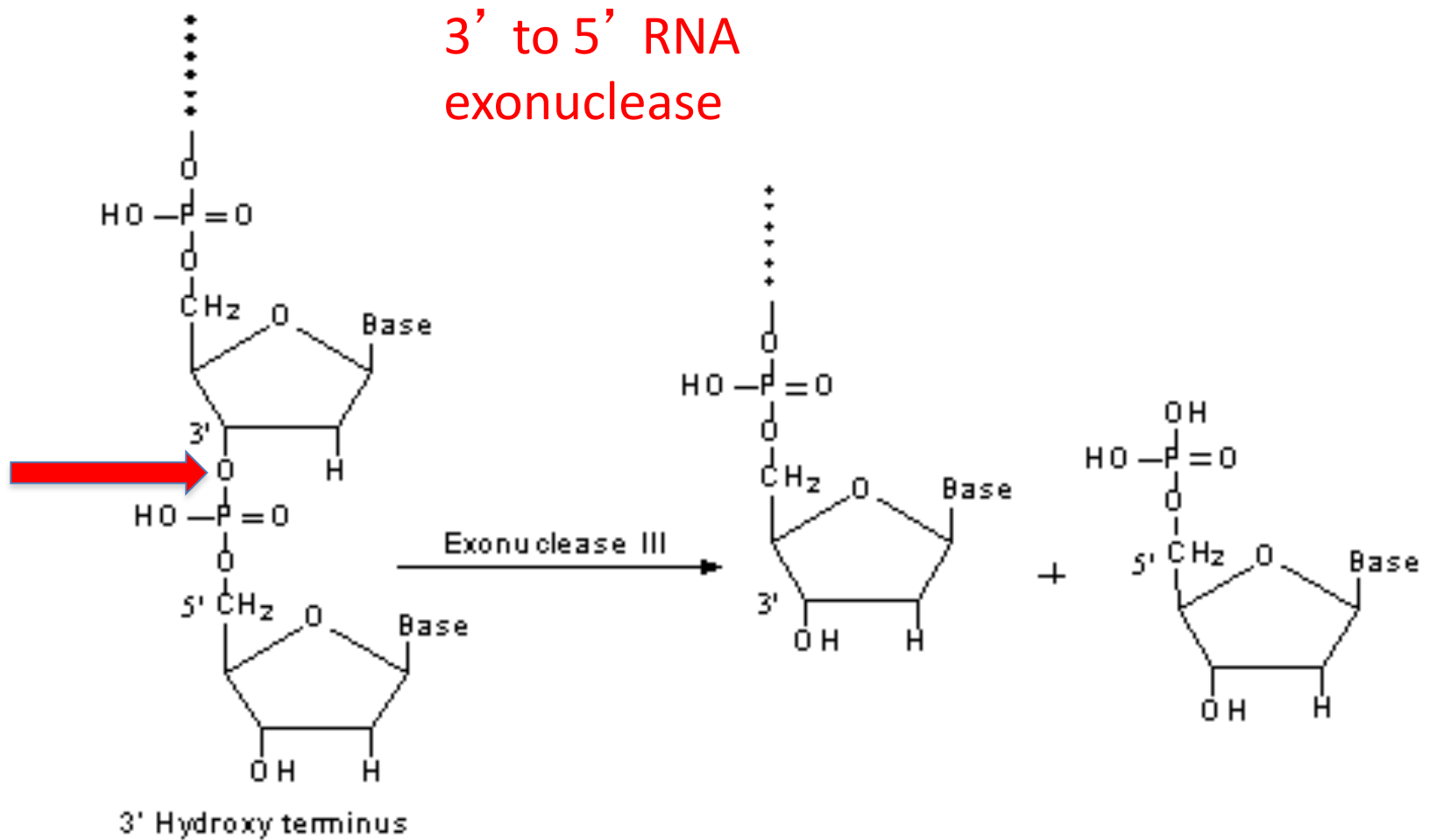

RNA degradation by hydrolysis!!

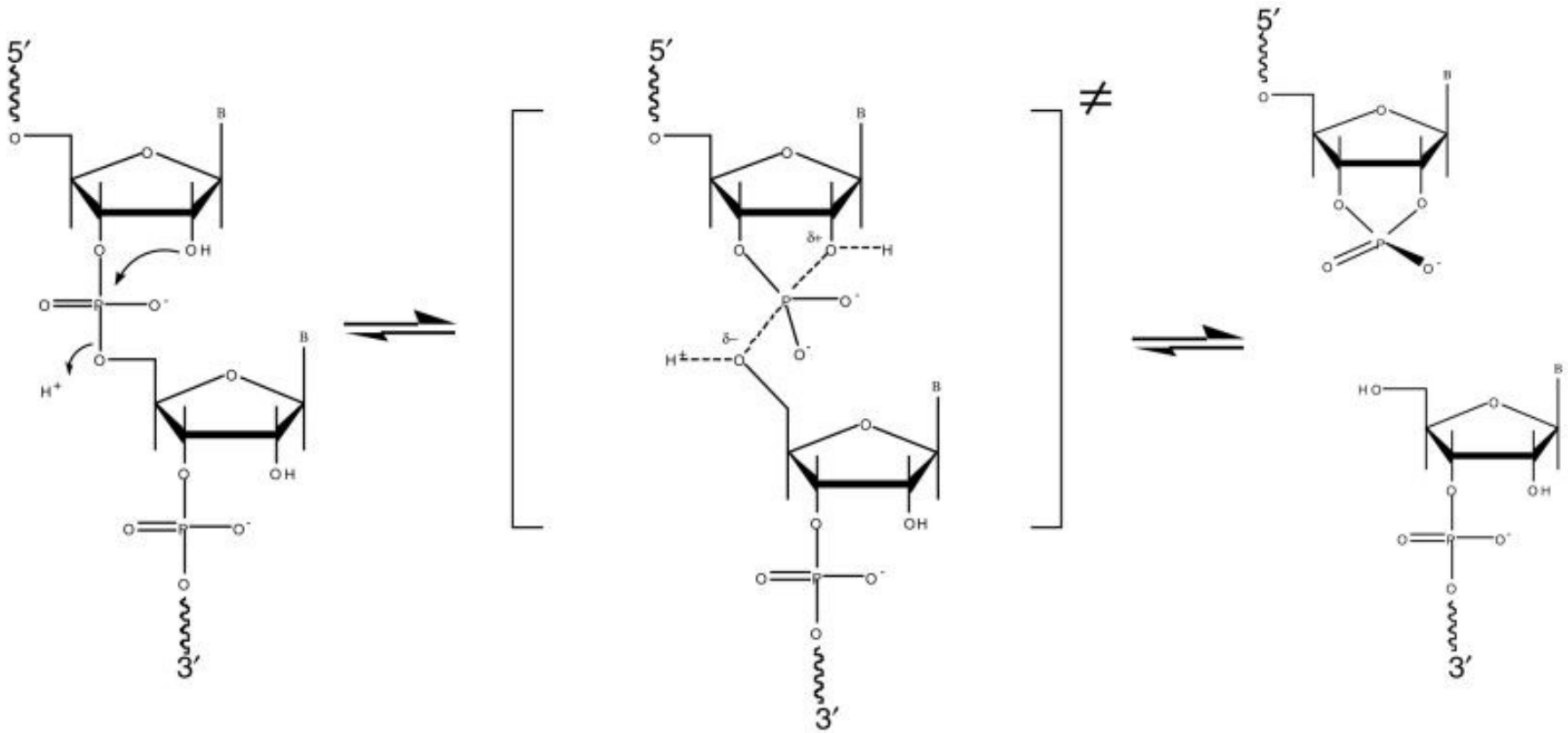

mRNA DEGRADATION

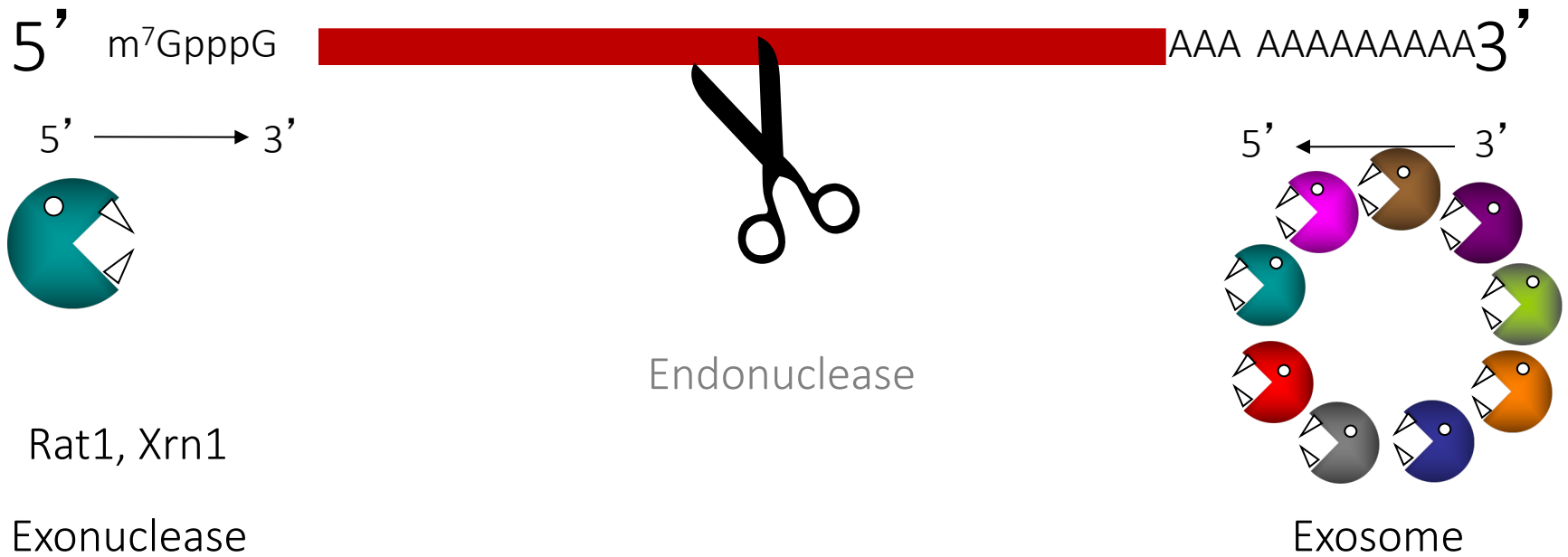

The degradation must be closely regulated in order to prevent wholesale elimination of all transcripts.

RNA DECAY

- Is mainly exonucleolytic – RNAs can escape the decay by simply protecting their ends with proteins and/or by structural elements.

Examples:

mRNA:

5' 7mGpppG cap plus cap-binding proteins

3' poly(A) tail with poly(A) binding proteins bound

tRNA, rRNA, snRNA, snoRNA:

complex secondary and tertiary structures

Base modifications

mRNA stabilizing and destabilizing features

- Protein binding elements
- RNA binding sequence elements
- Structural elements



Translation initiation complex

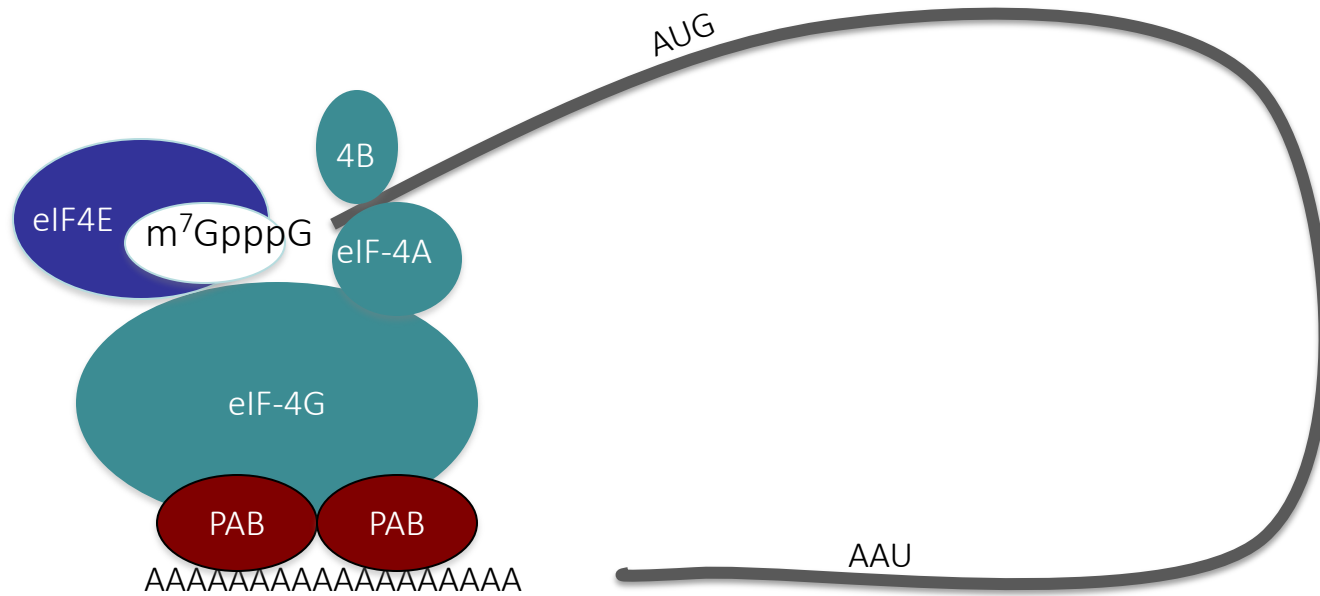

'Normal' mRNA degradation is initiated by deadenylation

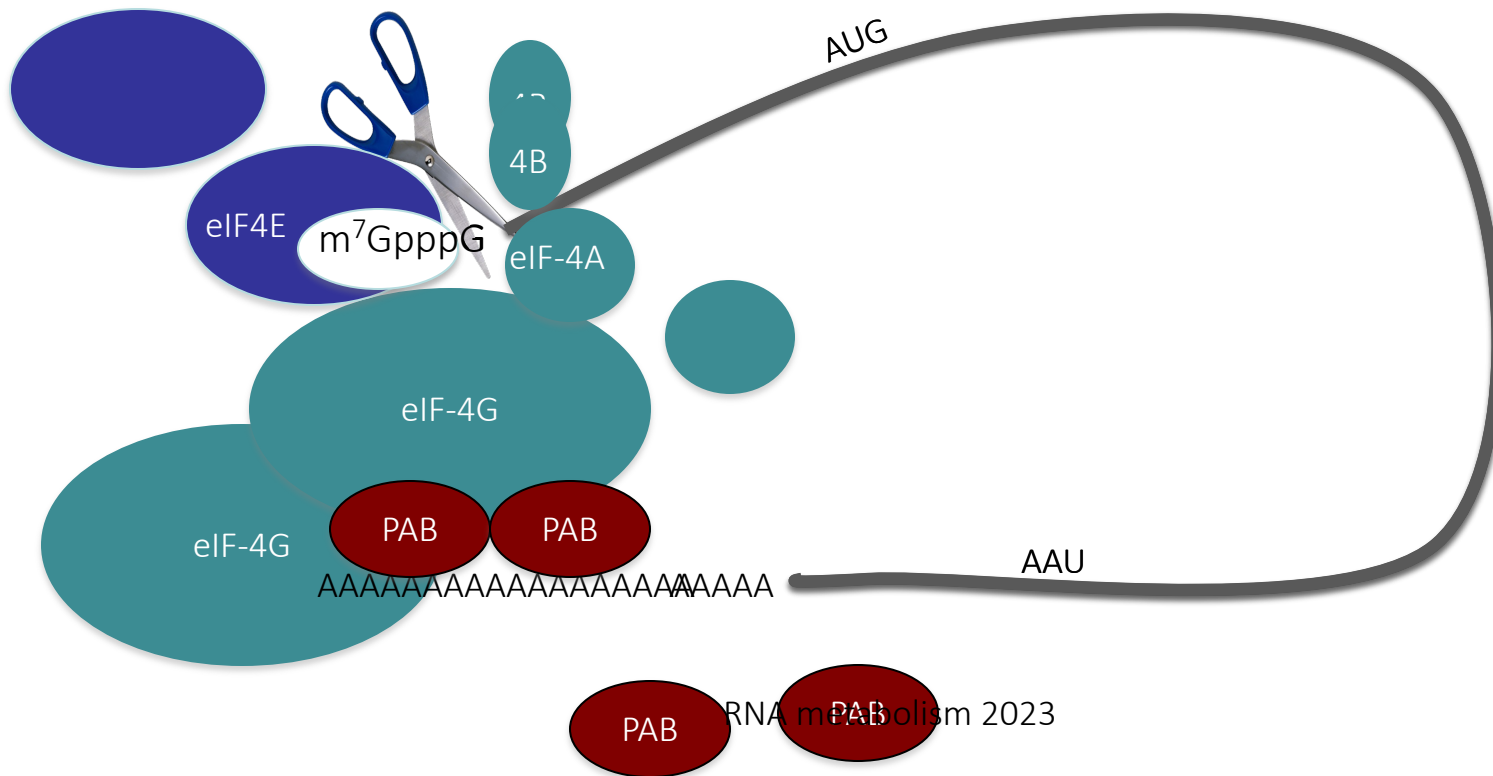

Deadenylation-dependent mRNA decay (in yeast)

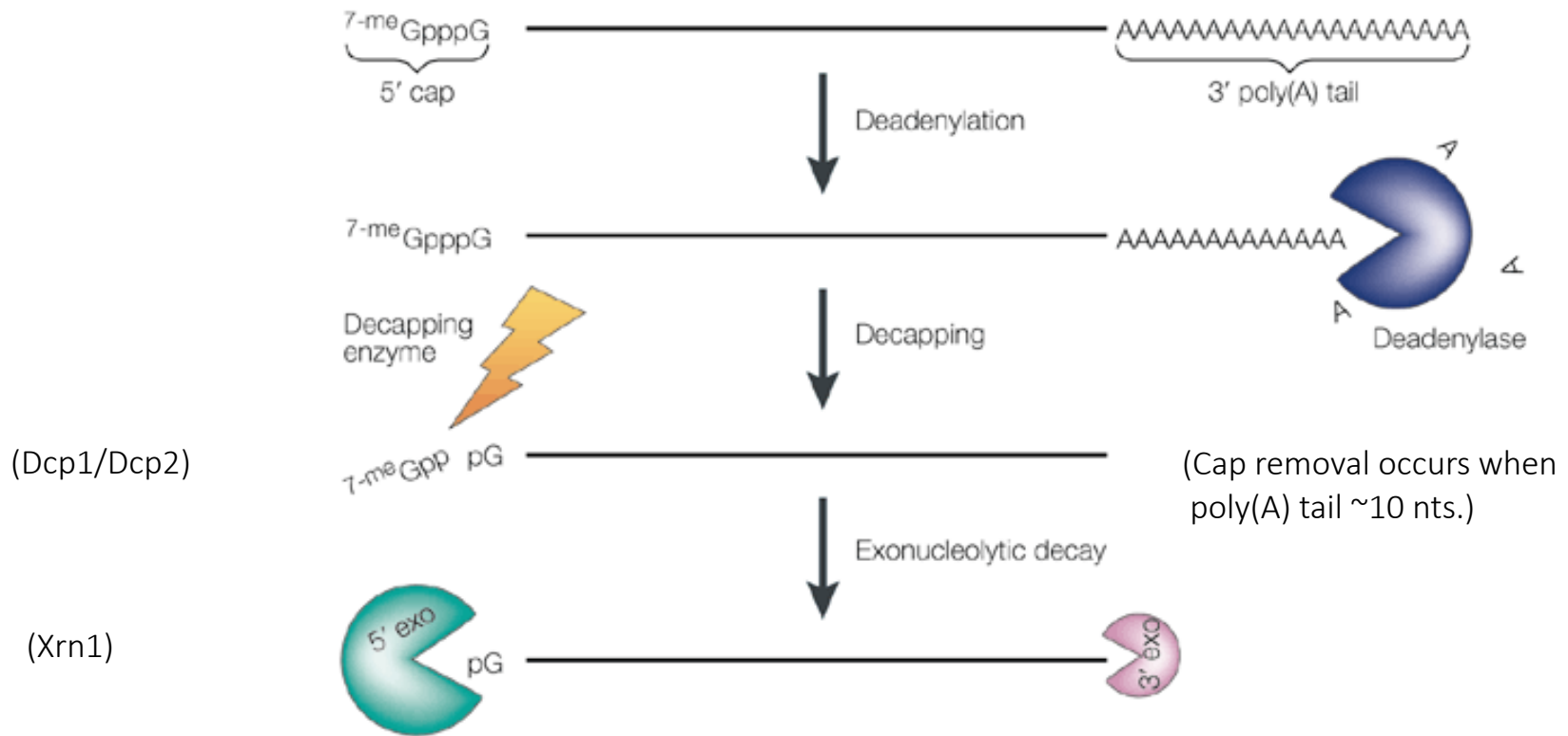

Molecular machines in mRNA degradation

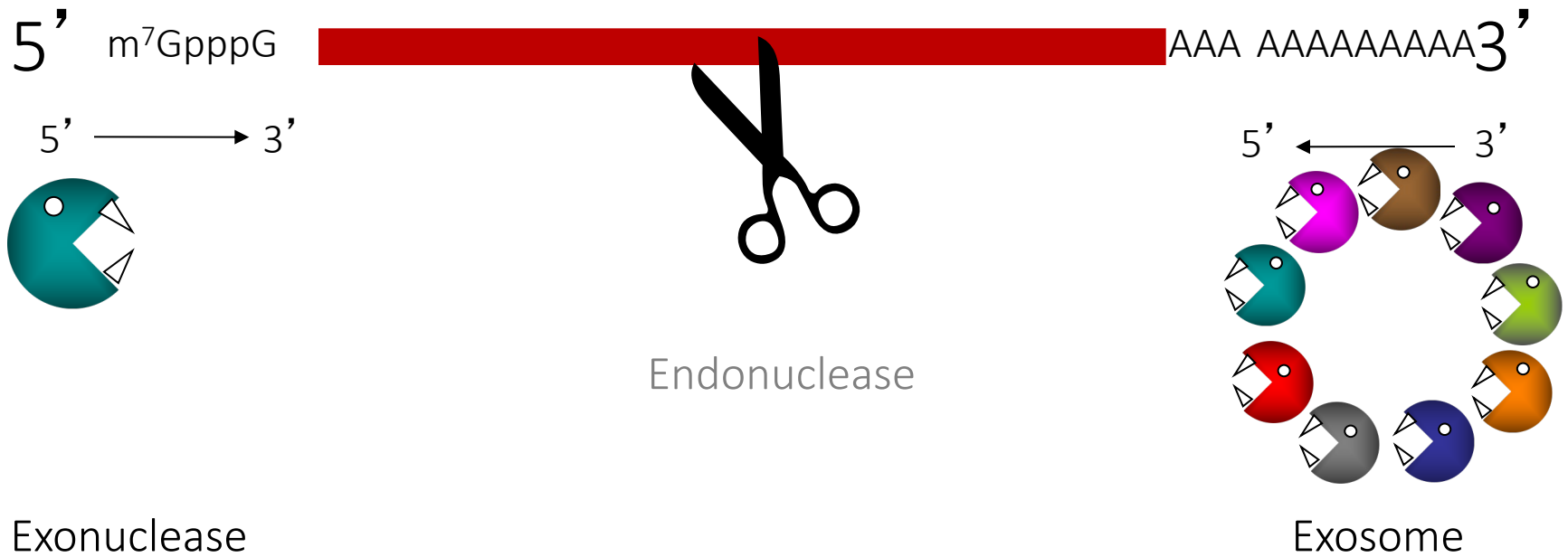

Rat1, Xrn1

Monomer, very potent, highly processive

needs cofactors and activation

The exosome

Associates with specific co-factors depending on localization

2 forms: nuclear and cytoplasmic

Exosome is poorly active in vitro and needs cofactors for activation

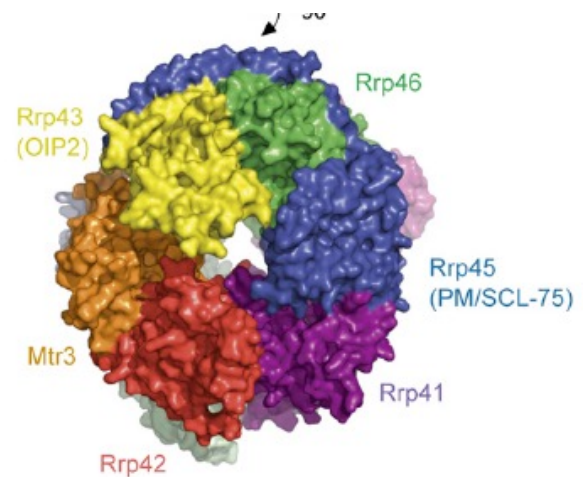

The RNA exosome and proteasome: common principles of degradation control

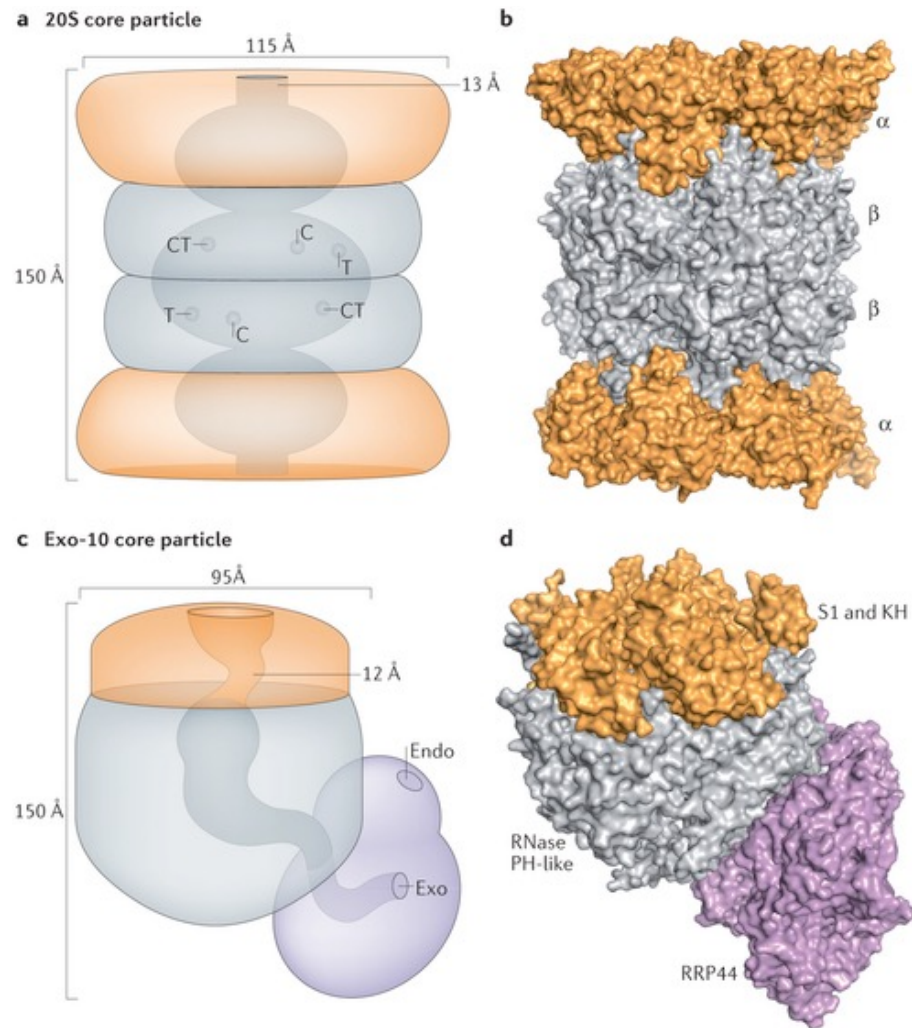

The RNA exosome and proteasome: common principles of degradation control

a Core complexes bound to ATP-dependent regulators

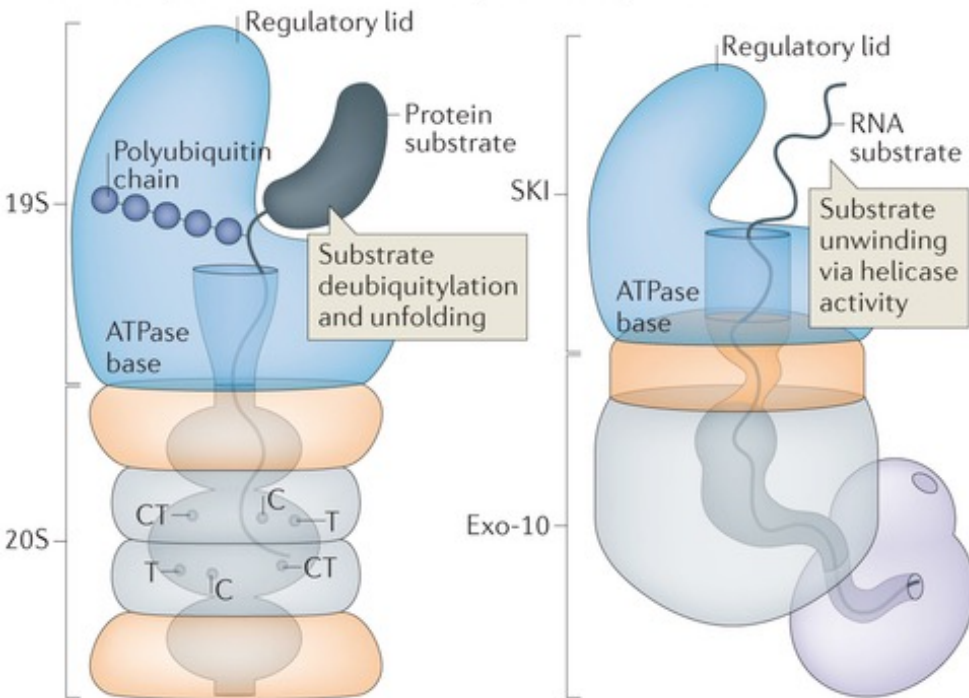

b Core complexes bound to ATP-independent regulators

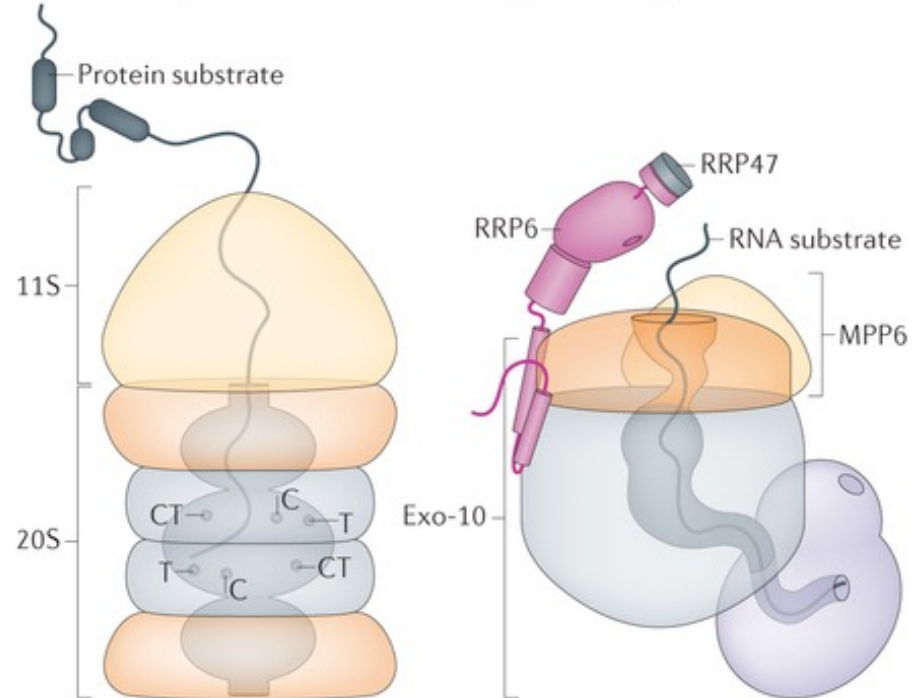

Nature Reviews | Molecular Cell Biology

RNA is fed through the barrel

A

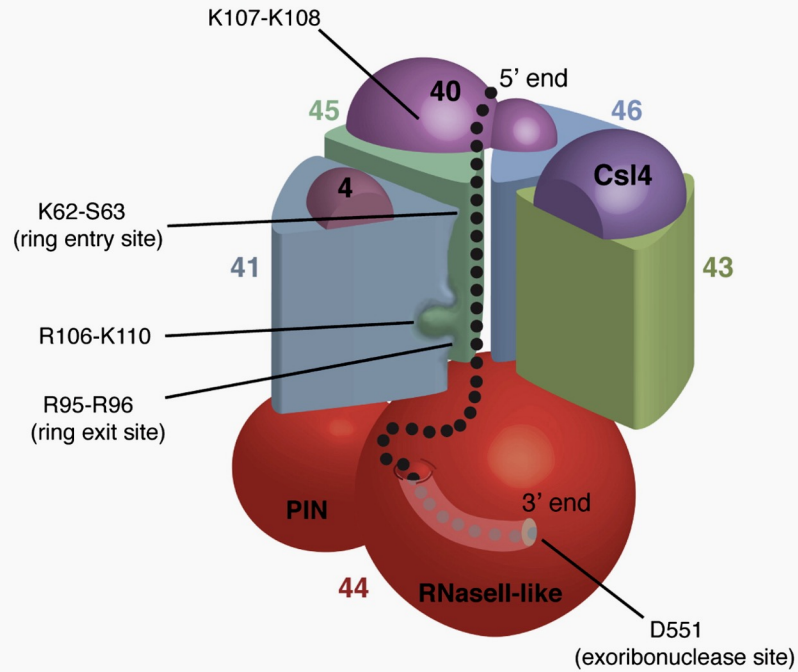

C

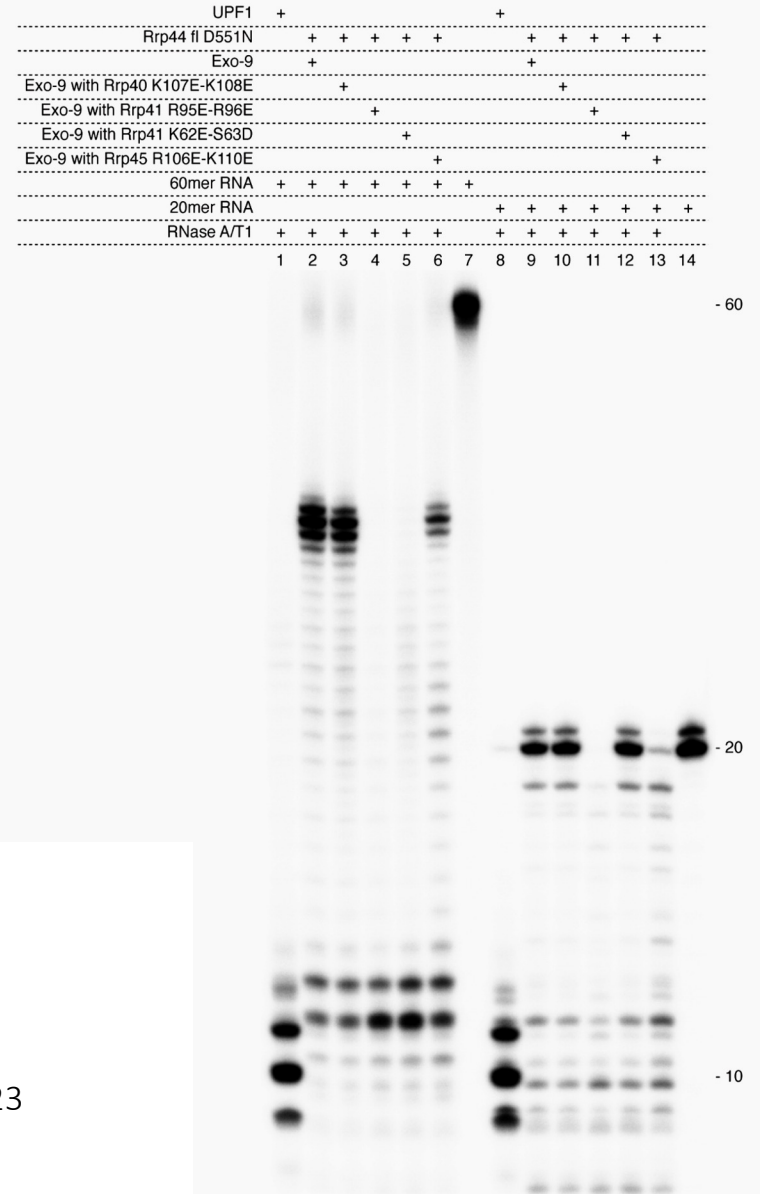

Endoribonucleolytic decay

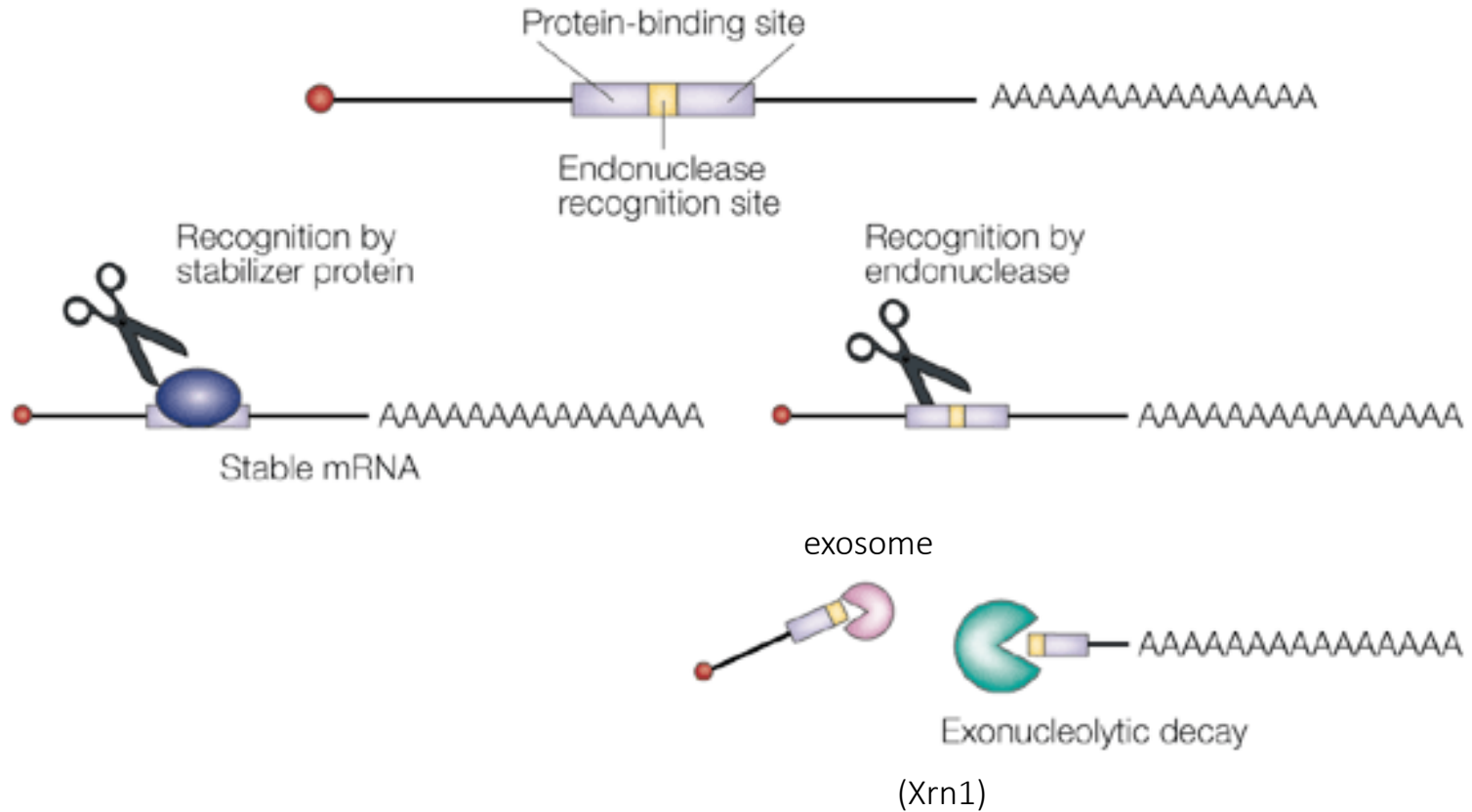

Uridylation marks mRNA for decay

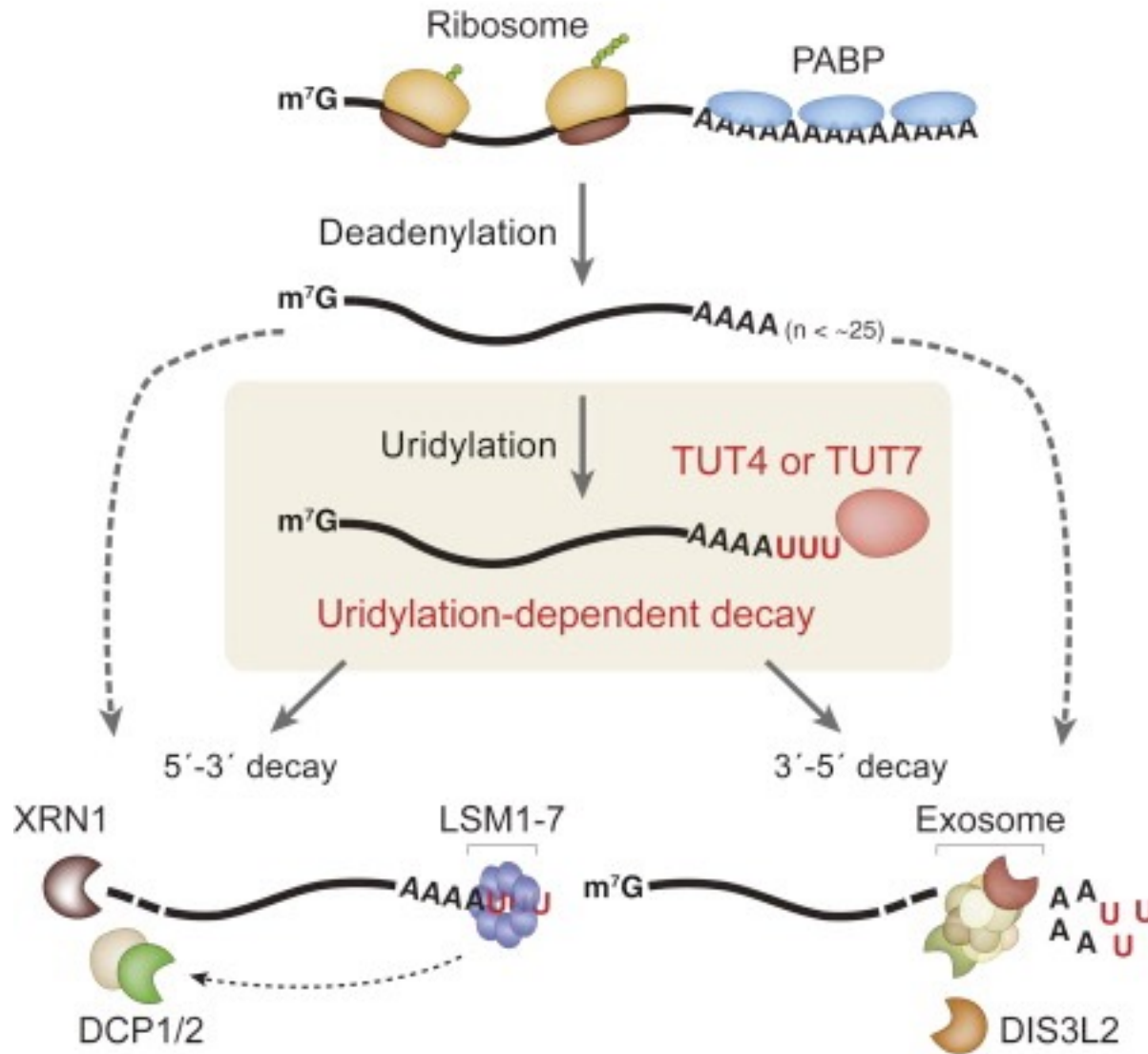

Lim et al. Cell 2014

Deadenylation dependent mRNA degradation

- The poly(A) tail is progressively shortened by a deadenylase enzyme until it reaches ~20 A residues or less
- The PABPI becomes destabilized and weakening its interaction with the 5' cap and translation initiation factors and also leads to an exposed 5' cap
- Some mRNAs are cleaved internally by endonucleases (e.g. the miRISC) before they are further degraded by 3' -5' exonucleases
- 5' caps can then be removed by decapping enzymes and unprotected 5' end is degraded by 5' -3' exonucleases
- The shortened poly(A) tail is also susceptible to 3' -5' exonucleases
- Oligouridylation of short poly(A) tail recruits Lsm complex, which in turn recruits decapping apparatus and induces degradation at the 5' end
- 5' decapping and subsequent degradation (from the 5' end) can occur independently of deadenylation

Regulatory sequence elements in mRNAs

Encoded:

- **AU rich elements** (ARE) in 3' UTRs – binding of specific proteins that recruit the exosome
- **Iron-responsive element** (IRE) and iron regulatory protein (IRP)
- Cell cycle-regulated histone mRNA **stem-loop** determinant (SL/SLBP)
- **Cytoplasmic polyadenylation element** (CPE).....

Specialized mRNA turnover pathways

- ARE-mediated mRNA decay

Regulatory sequences in mammalian mRNAs

ARE-binding proteins affect mRNA stability, translation and subcellular localization.

- ARE's (adenylate- uridylate-rich instability elements) in mRNA's enhance deadenylation and decay rates (but some ARE's can stabilize mRNA's);
- ARE's are bound by factors (e.g., HuR/HuA, AUF1/hnRNP D) that modulate stability of ARE-containing mRNA's; mechanism of action not clear

Other elements found in the 5' UTR and coding regions also modulate transcript stability.

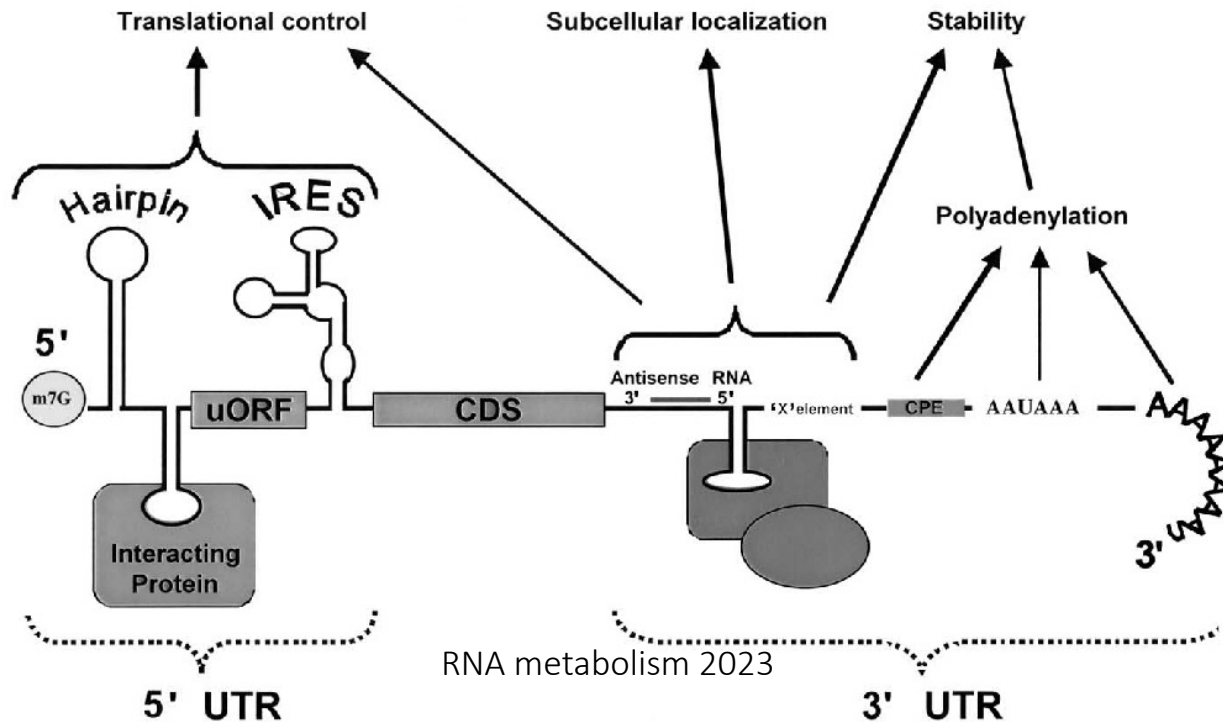

ARE-Mediated mRNA Turnover

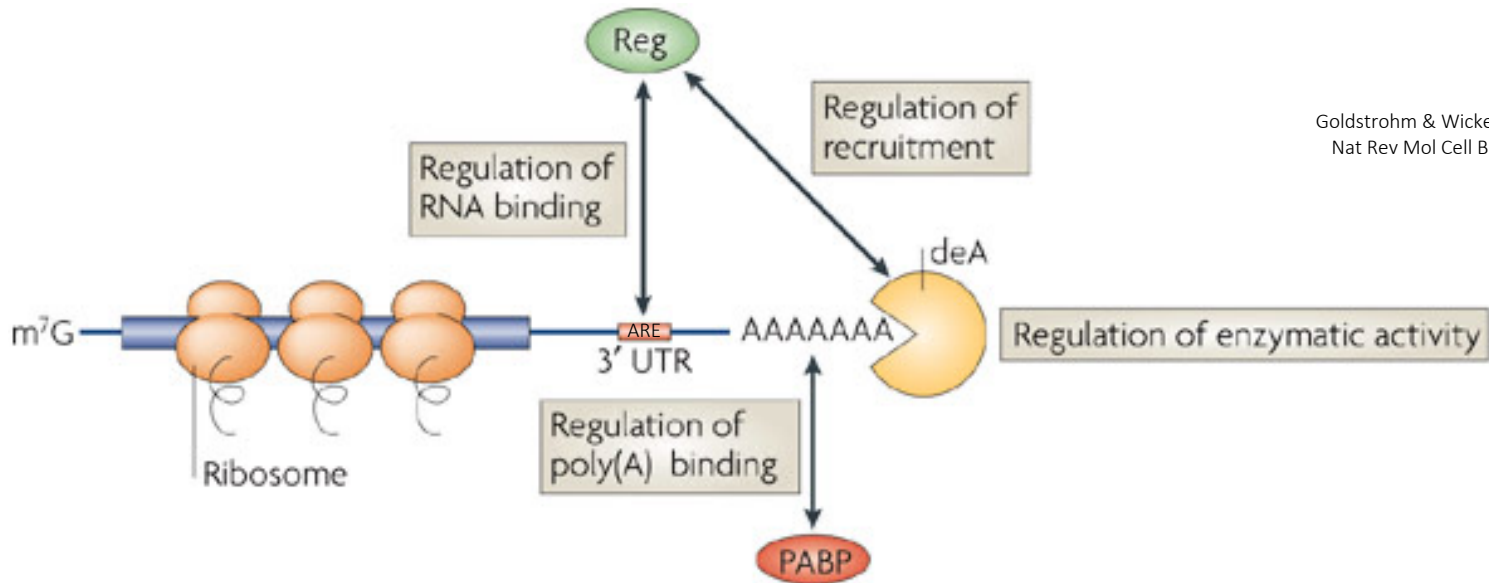

Goldstrohm & Wickens (2008)
Nat Rev Mol Cell Biol 9:337

- AU rich elements (50-150nts)
AUUUA; UUAUUUA(U/A)(U/A); or U-rich
- cis-acting element located in 3' UTRs of mRNAs
- transcripts that encode proteins that require rapid changes in response to stimuli such changes in the cell cycle, growth factors, response to microorganisms, inflammatory stimuli, and environmental factors
- 10% of mammalian mRNAs contain AREs

- A diverse set of trans-acting proteins bind to AREs. These proteins can mediate other protein interactions that modulate mRNA stability. Various ARE-associated proteins can promote rapid mRNA turnover by promoting enhanced decapping, deadenylation, exosome recruitment, endonucleolytic cleavage or combinations of these. Alternatively, some proteins that bind to AREs can stabilize the mRNA.

Example of ARE-mediated change in mRNA Levels before and after the DNA damage response

(a) ARE-mediated destabilization prior to the DDR

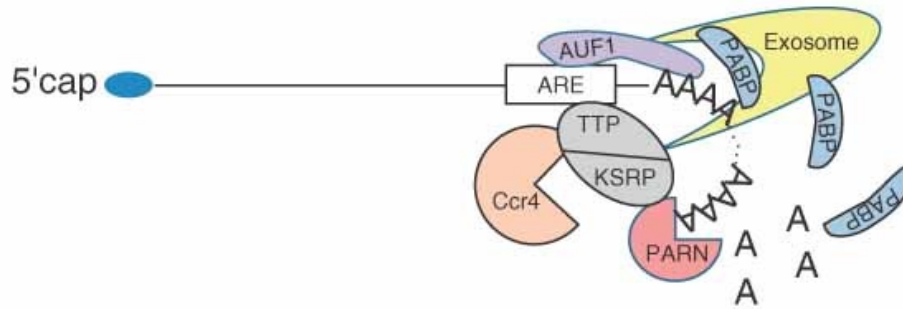

Under non-damage conditions:

- AUF1 competes with the PABP for poly(A) tail binding, exposing it to PARN; TTP (tristetraproline) and KSRP (KH-type splicing regulatory protein) recruit PARN and CCR4 to deadenylate prior to degradation by the exosome.

(b) ARE-mediated stabilization during the DDR

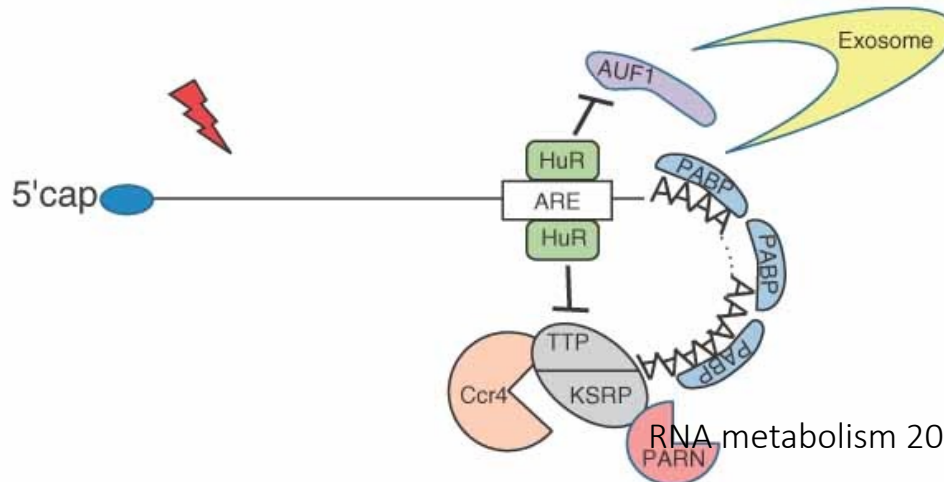

Under DNA damage conditions:

- Genes involved in the DNA damage response pathway are up-regulated. HuR is up-regulated and competes with AUF1 for binding to the same ARE region. Loss of AUF1 binding stabilizes PABP association with the poly(A) tail. HuR also competes with TTP and KSRP to prevent recruitment of the deadenylases and exosome.

Extremely long lived mRNAs in humans?

MINIREVIEW

Regulation of α -Globin mRNA Stability

SHELLY A. WAGGONER AND STEPHEN A. LIEBHABER¹

*Department of Genetics and Medicine, University of Pennsylvania School of Medicine,
Philadelphia, Pennsylvania 19104*

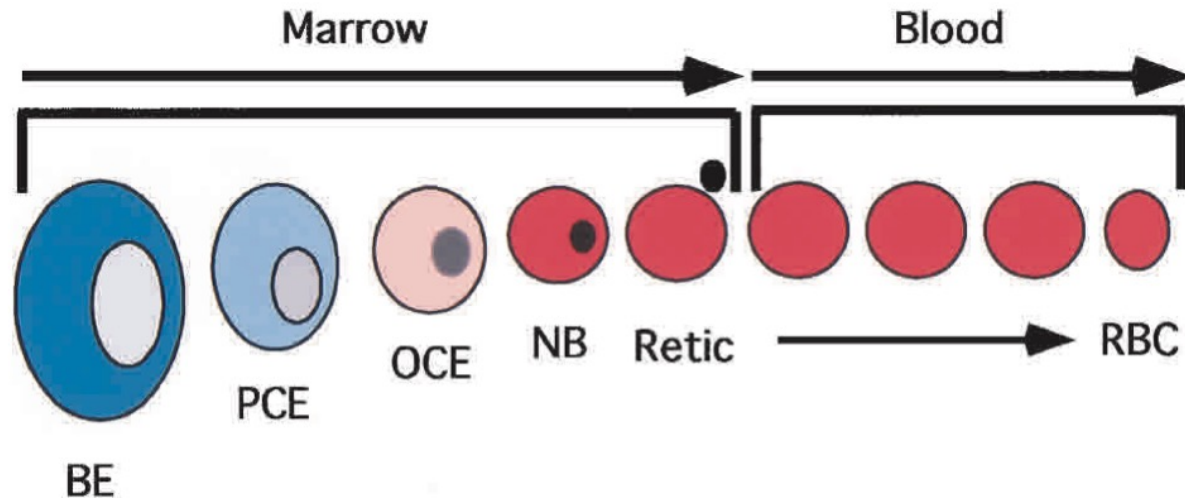

Figure 2. Stages of erythropoiesis. The name of each cell type is indicated by its abbreviation (see text for full names). The nucleus is shown as progressively darkened and condensed and is eventually extruded from the cell during the transition to the reticulocyte (retic) stage. The colors of the cells are shown as visualized by Wright/Giemsa staining.

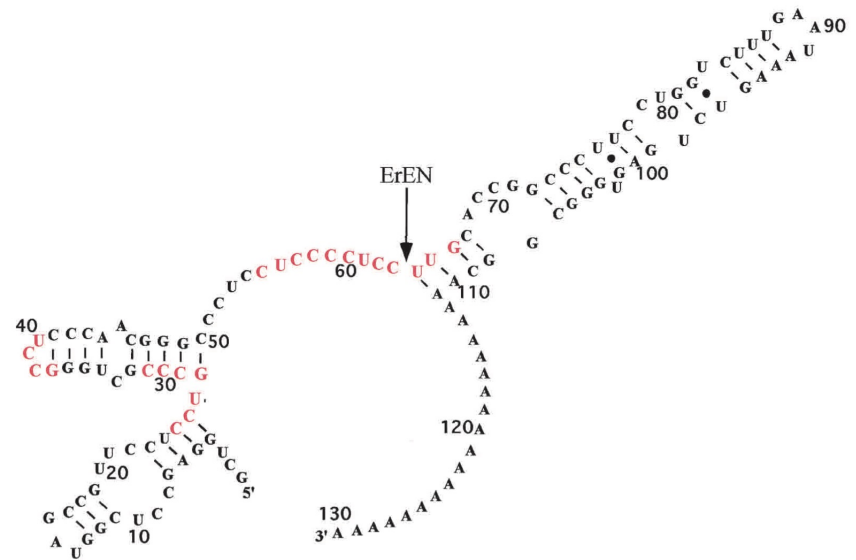
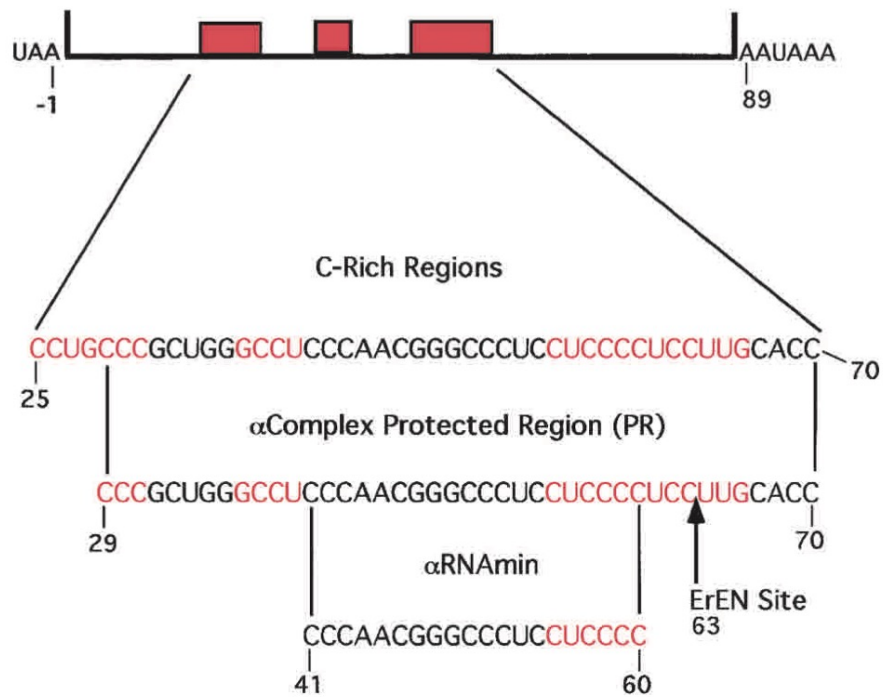
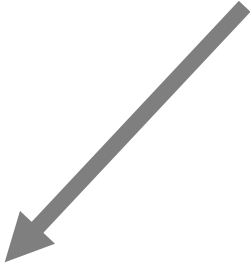
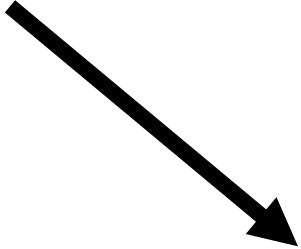

Figure 3. Important sequence determinants in the α -globin 3'-UTR. A segment of the α -globin 3'-UTR is illustrated, with the translational stop codon (UAA) and cleavage and polyadenylation signal (AAUAAA) indicated. The nucleotides are numbered in this and the following figures such that the first nucleotide 3' to the stop codon is nucleotide 1. The red boxes and red sequences represent the C-rich regions that comprise the stability determinant. Also shown are the sequences of the α -complex protected region (PR) that contains the ErEN Site and the minimal α -complex binding site (α RNAmin).

mRNA DEGRADATION



mRNA DECAY



QUALITY CONTROL

mRNA quality control

RNA quality control and degradation in the cytoplasm

Aim: To prevent translation of mRNAs that would generate aberrant proteins

-targets mainly mRNAs

- Almost 20% of mRNAs in humans have a premature stop codon. All of these are degraded by NMD. Where do you think all these mistakes are coming from? That is, which process in the biogenesis of an mRNA molecule is the most prone to errors?

Alternative pre-mRNA splicing can create enormous diversity

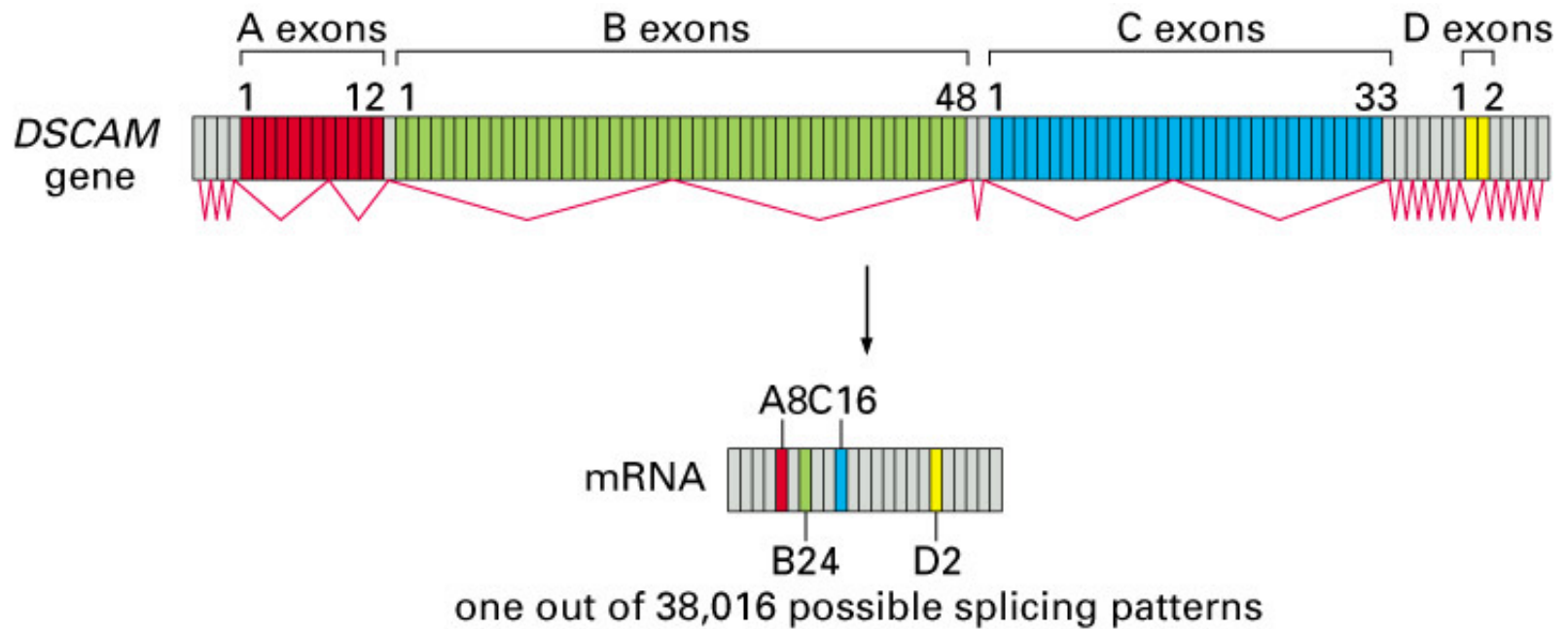
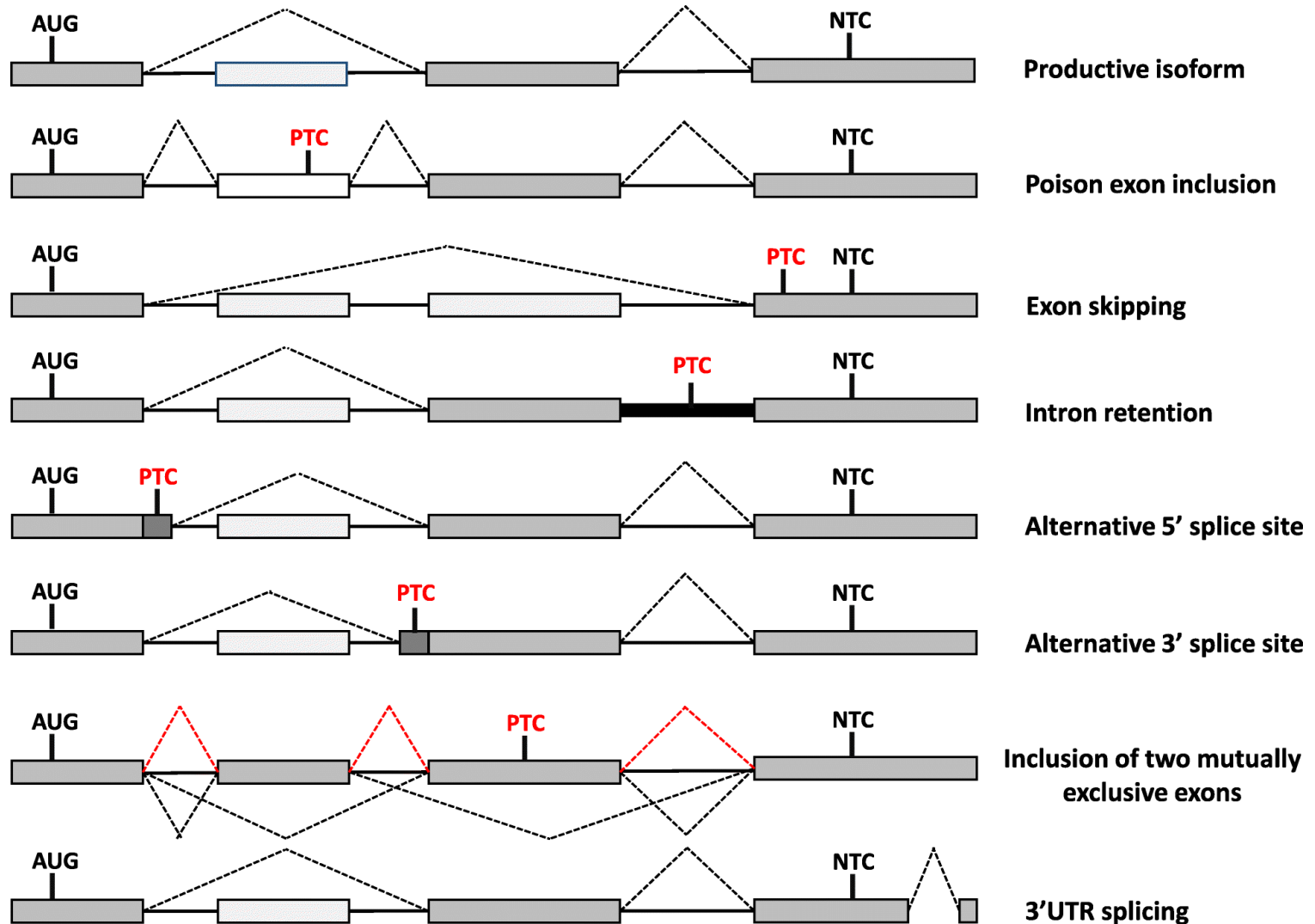
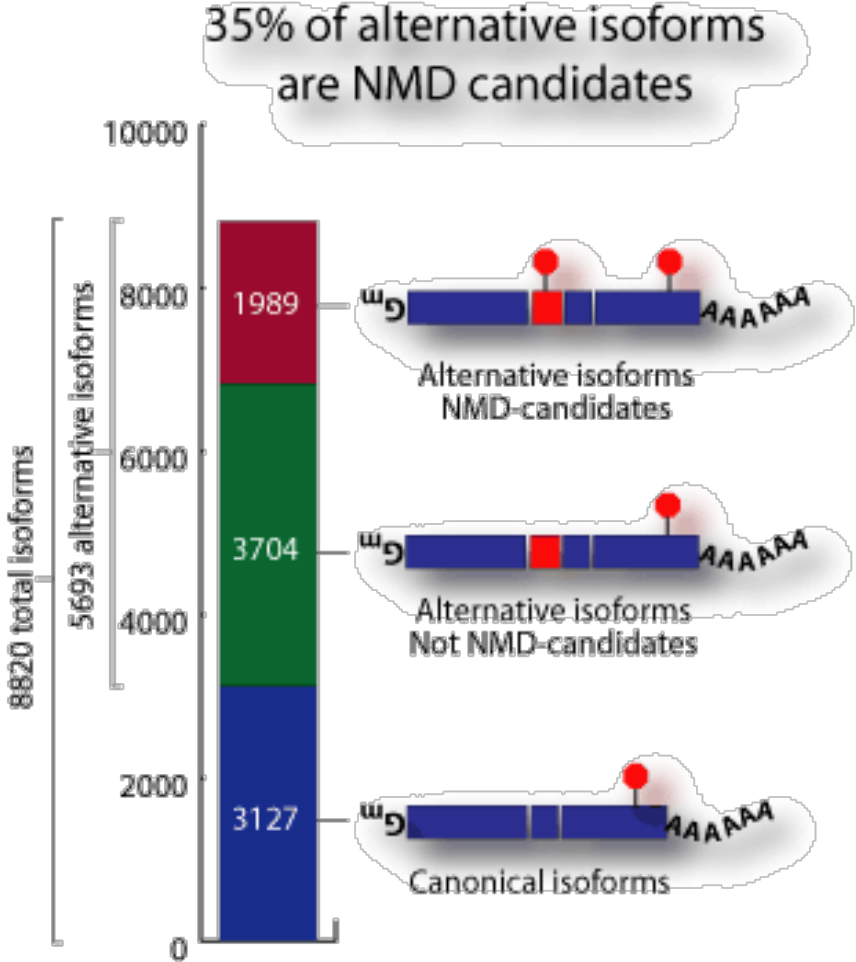

Figure 7-89. Molecular Biology of the Cell, 4th Edition.

Schematic representation of alternative splicing (AS) patterns inducing nonsense-mediated mRNA decay (NMD)-sensitive mRNA isoforms



RNA quality control in the cytoplasm: NMD



NMD regulates the expression of transcripts associated with diverse cellular processes.

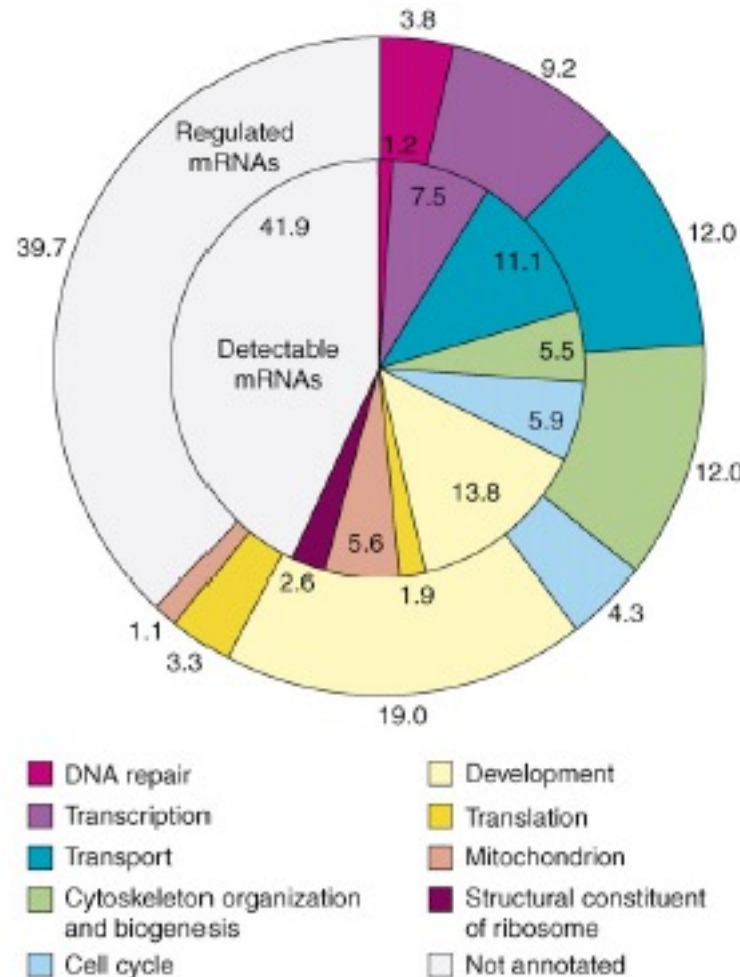

Aberrant mRNA Decay Pathways

A. Nonsense-mediated mRNA decay (NMD)

- Degrades mRNAs with premature stop codons

B. Nonstop mRNA decay (NSD)

- Degrades mRNAs without a stop codon

C. No-go mRNA decay (NGD)

- Degrades mRNAs that have a stalled ribosome

D. Ribosome extension-mediated decay (REMD)

- Degrades mRNAs where ribosome translates past the stop codon and into the 3' UTR

RNA quality control in the cytoplasm

Nonsense mutations in the coding regions of mRNAs can lead to:

1. Generation of a premature termination codon (PTC) → shorter protein product

NONSENSE MEDIATED DECAY = NMD, SMD

2. Loss of the termination codon- nonstop message → longer protein product

NONSTOP DECAY = NSD

Both these surveillance pathways depend on a ‘test’ round of translation that can detect the presence of stop codons.

RNA quality control in the cytoplasm: NMD

NMD = Nonsense-Mediated Decay

Is initiated when mRNA contains:

- a premature stop codon
- an in-frame stop codon within a retained intron
- an extended 3' UTR due to improper polyadenylation site use
- an ORF in their 5' UTR

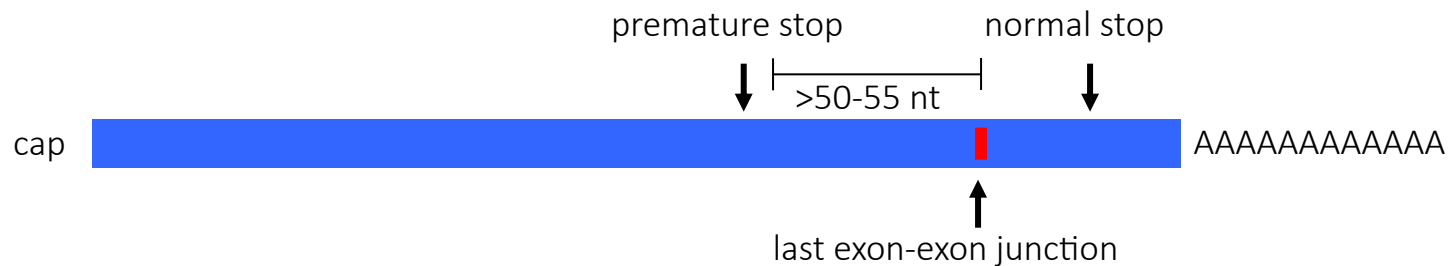

It has been estimated that 30% of inherited genetic disorders in humans result from nonsense mutations or frameshift mutations, which generate PTCs

Yet, most of these diseases are recessive (i.e. the truncated protein is not made and thus cannot interfere with the function of the wild type protein)

Nonsense-Mediated mRNA Decay

- Specialized pathway that degrades mRNAs that contain premature translation termination signals



Czaplinski et al. (1999)
Bioessay 21:685

- Protects the cell from translating mRNAs that might produce truncated peptides that could lead to harmful dominant negative effects
- Occurs in all eukaryotes.
- 30% of disease-generating mutations result in premature stop codons
- Up to 10-20% of the transcriptome is regulated by NMD
- PTC-containing transcripts caused by point mutations, frameshift mutations, mRNAs with faulty alternative splicing, pre-mRNAs that escape nuclear retention, mRNAs that contain upstream open reading frames, mRNAs that carry introns in 3' untranslated regions, or mRNAs with long 3' untranslated regions

NMD = Nonsense-Mediated Decay

Two main steps:

1. PTC recognition
2. Initiation of mRNA degradation

Rules for eliciting NMD according to the two models of NMD activation in human cells.

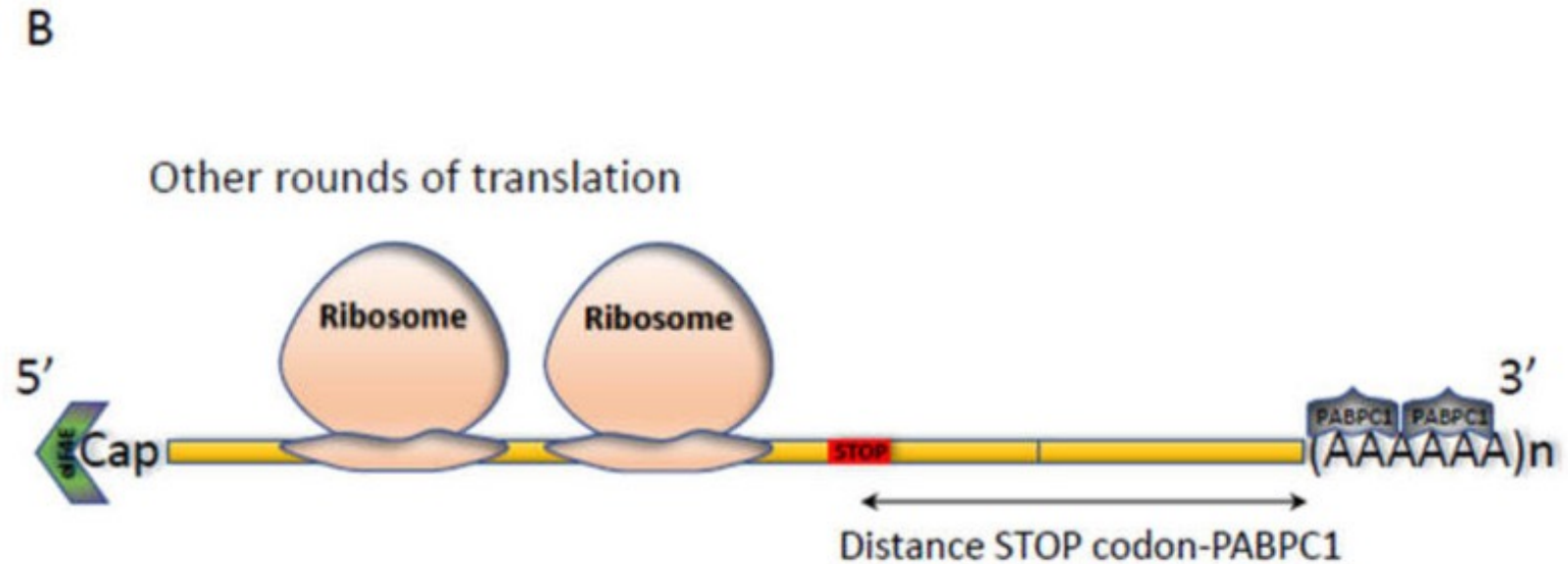
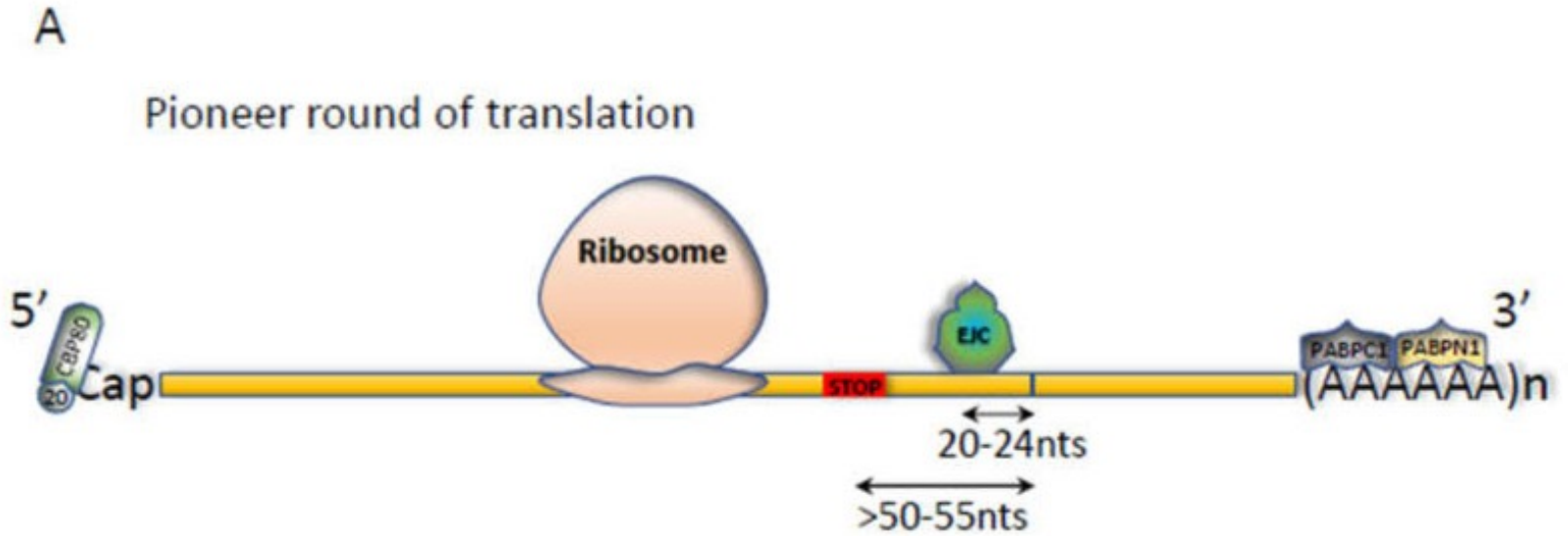

Examples of natural NMD substrates

short ORF in the 5'UTR

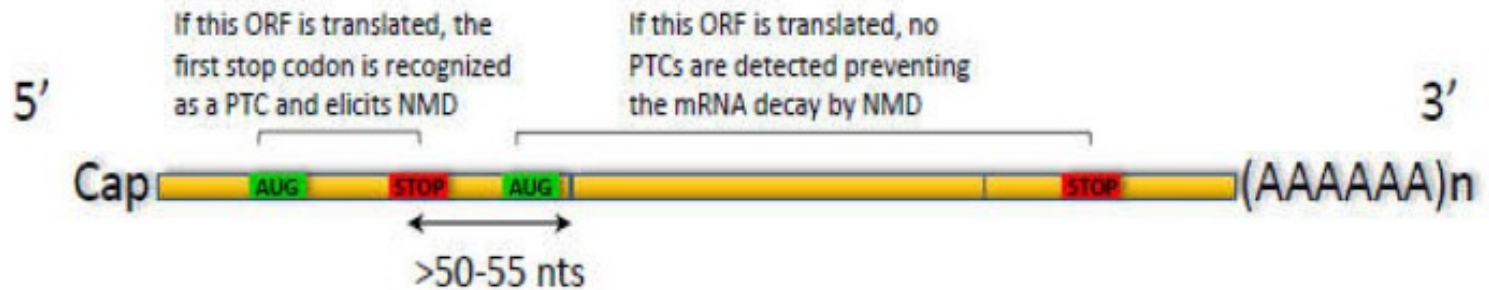

Splicing event in the 3'UTR at more than 50-55 nucleotides downstream of the physiological STOP codon



Intron retention

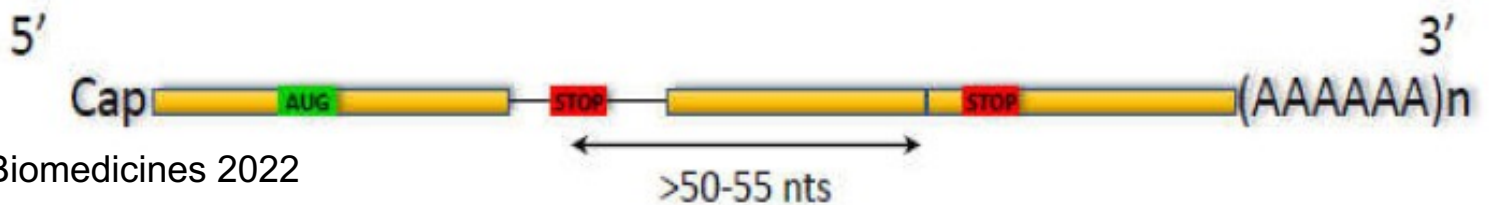

Examples of natural NMD substrates

mRNA with a long 3'UTR

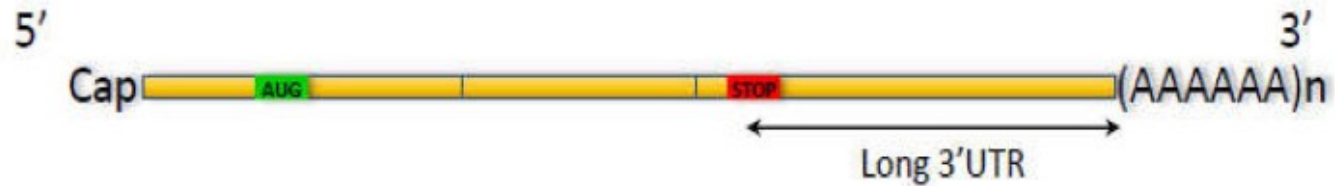

mRNA encoding for a selenoprotein

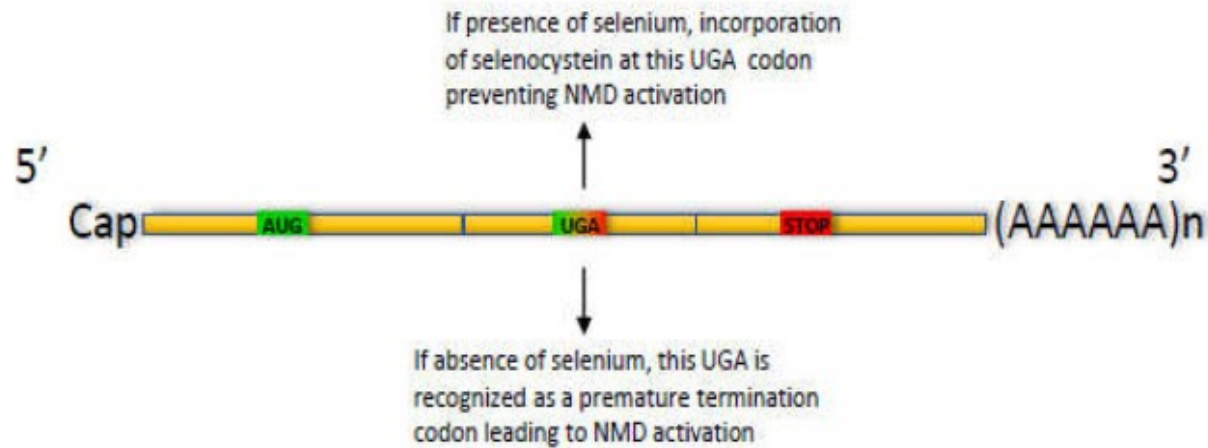

PTC recognition

Yeast

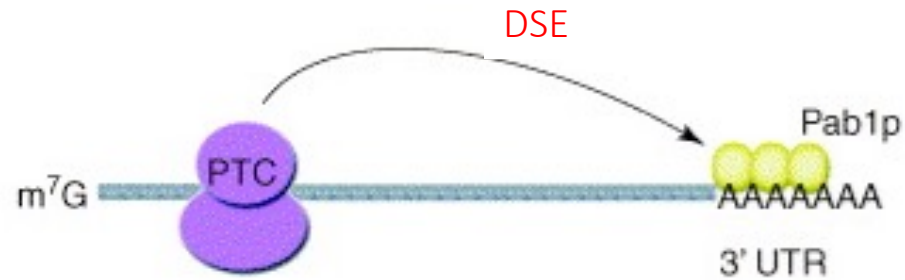
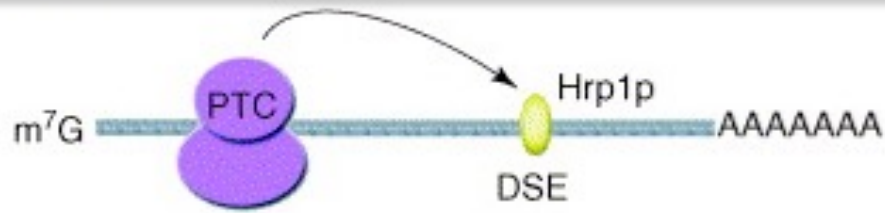

Mammals

Mammals

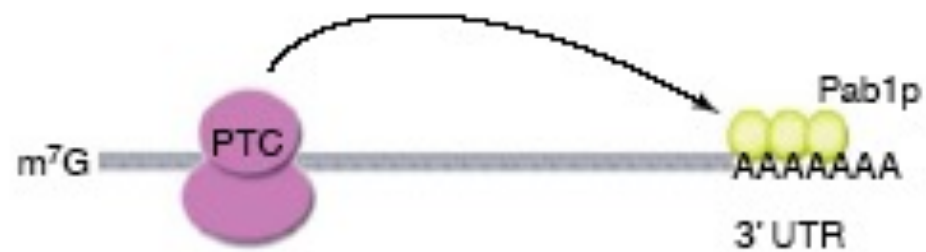
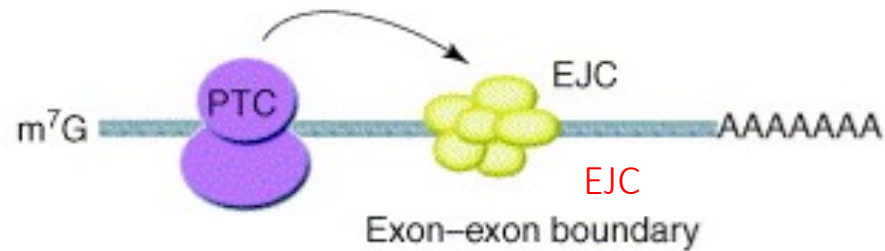

SMD in mammals

SMD = Staufen1 (Stau1) mediated decay.

Independent of EJC. Doesn't require splicing.

Involves Stau1, Upf1.

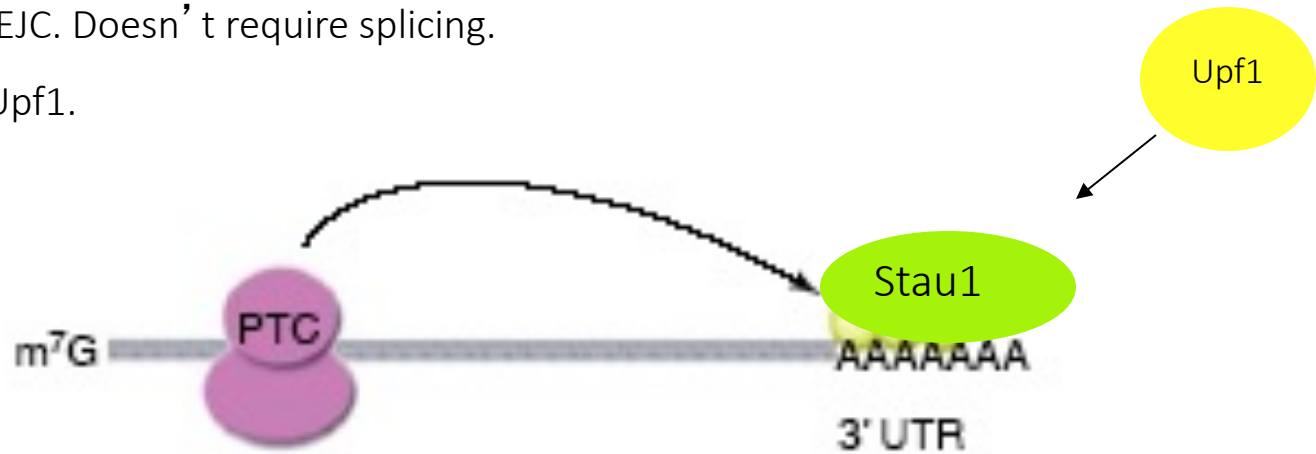

Stau1 binds to the 3' UTR of a subset of particular mRNAs

NMD versus Staufen1 decay pathways

PTC recognition

Mechanism by which a stop codon is defined premature and the targeted mRNA is degraded differ across species: but in all depends on a test round of translation

1. Mammals

- Cross-talk between terminating ribosome and downstream EJC (exon-junction complex)
- Premature Stop Codons (PTC) defined as premature if they are located >50 nt upstream of an exon-junction complex
- Mammals: PTC recognition relies on splicing or on Staufen protein (SMD)
- depends on a ‘test’ round of translation that can detect the presence of stop codons.

2. Yeast and invertebrates

- PTC recognition doesn't depend on splicing, intronless mRNAs subjected to NMD
- depends on loosely defined sequence elements, and/or on the interaction with other proteins bound downstream on the mRNA
- stop codon has to be in the “appropriate context”

Decay of NMD targets

Yeast and mammals

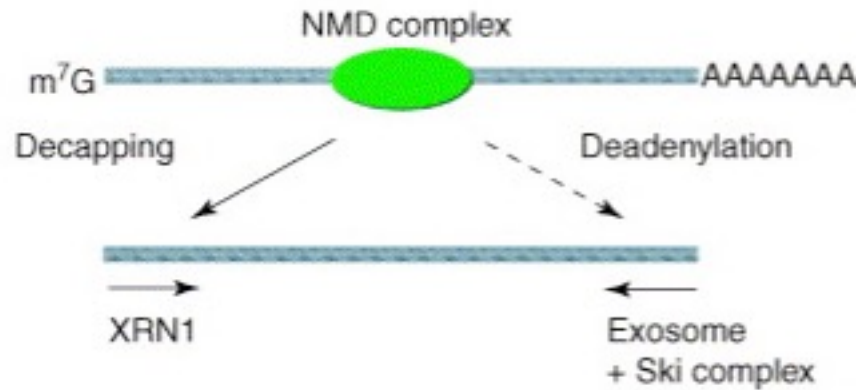

Drosophila

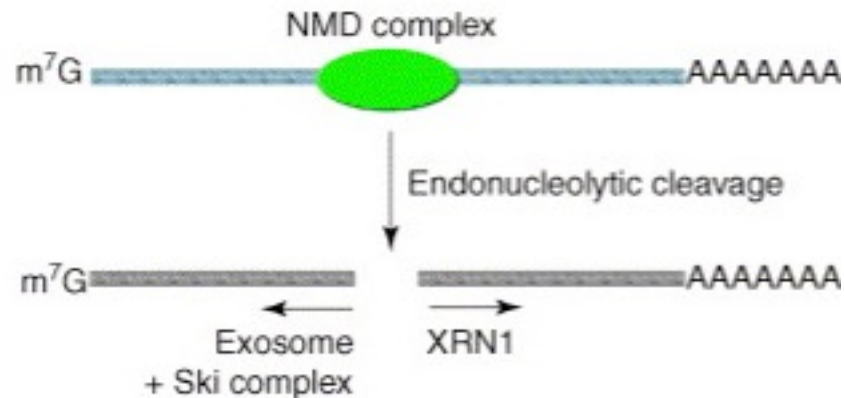

NMD substrates are targeted for degradation via interaction with Upf proteins

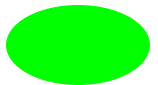

NMD Factors Associate With the EJC

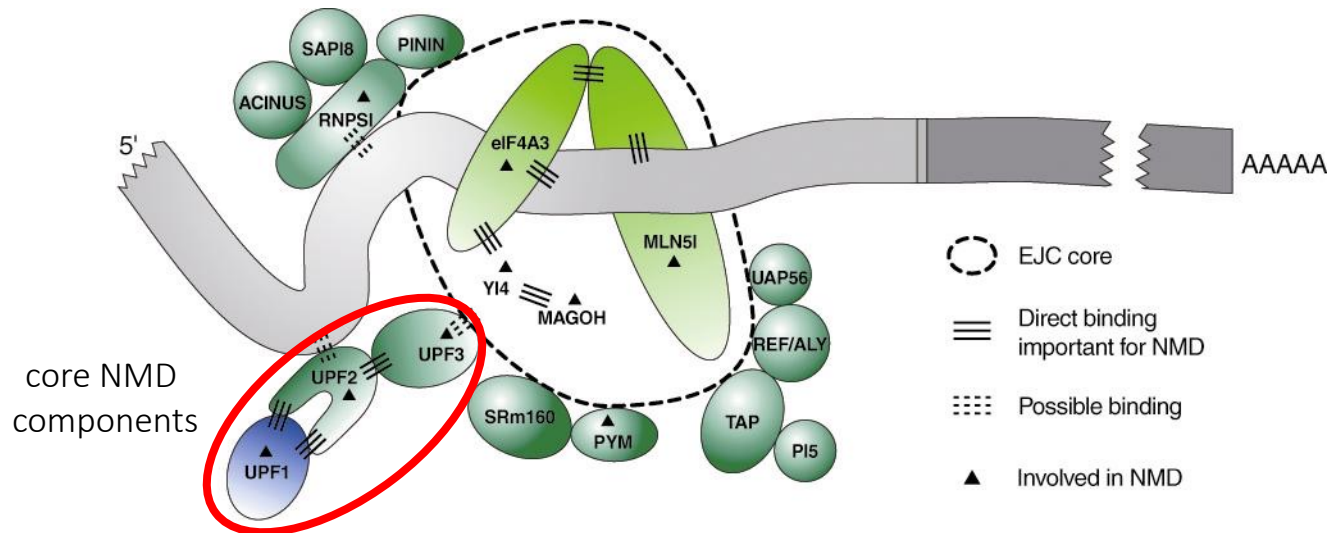

 Chang Y-F, et al. 2007.
Annu. Rev. Biochem. 76:51–74

Core NMD Components:

UPF3: associates with the EJC in the nucleus

UPF2: perinuclear and binds to Upf3 as the mRNA is exported

UPF1: associates at the stop codons in mRNAs during translation

Simplified representation of the nonsense-mediated mRNA decay (NMD) model in mammalian cells

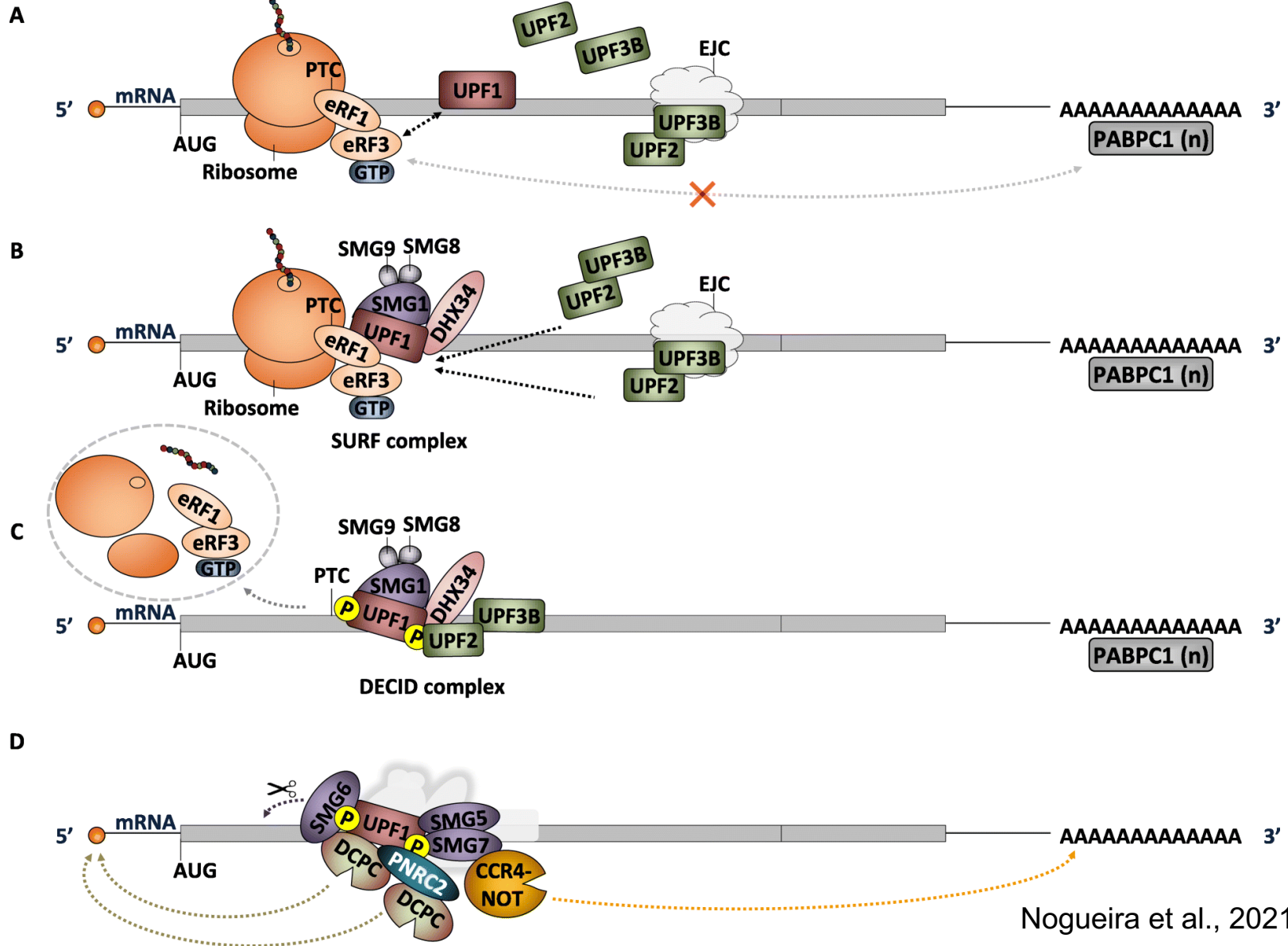

Initiation of mRNA degradation

Major role of 3 conserved proteins UPF1,2,3 (Up-Frameshift):

UPF3 - nuclear protein, associates with EJC of spliced mRNAs (positioned 20-24 nt upstream of exon-exon boundary)

has an RBD that contacts UPF2

UPF2 - perinuclear, associates with Upf3, UPF2/3 dimer binds mRNA via UPF2 surface, it can also interact with UPF1

UPF1 - cytoplasmic, RNA helicase, key component of NMD

associates with eRF1 and eRF3

binds to Upf2/3 dimer

regulated by phosphorylation in multicellular organisms - role for SMG1-7 proteins

Recognition of PTC recruits UPF1 binding that can then interact with downstream UPF2/3 forming surveillance complex

NMD effectors and phenotypes across species

Organism	Effectors	Phenotype
Yeast: <i>S. cerevisiae</i>	Upf1 Upf2 (Nmd2) Upf3	Not essential
Worm: <i>C. elegans</i>	SMG-2 (UPF1) SMG-3 (UPF2) SMG-4 (UPF3) SMG-1 SMG-5 SMG-6 SMG-7	Viable worms with morphological effects on genitalia
Fruitfly: <i>D. melanogaster</i>	UPF1 UPF2 UPF3 SMG1 SMG5 SMG6	Required for cell-cycle progression and proliferation
Mammals: <i>Mus musculus</i>	Upf1 (Rent1) Upf1 KO: embryonic lethal; Upf2 Upf3 Smg1 Smg5 Smg6 Smg7	required for cell cycle progression Upf2 KD: no effect on cell viability

Nonsense-mediated RNA decay and its bipolar function in cancer

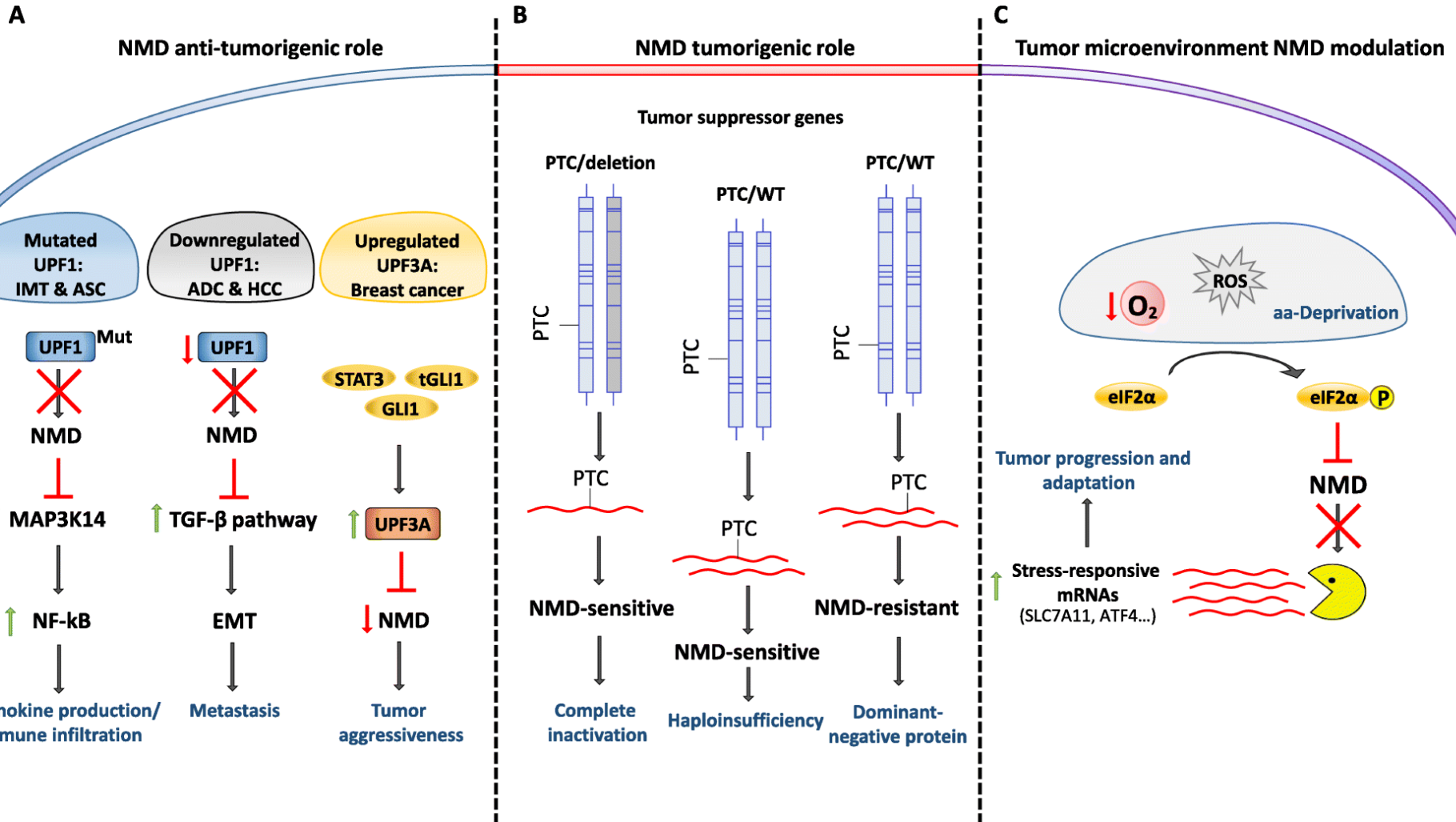

Nogueira et al., 2021

Summary of nonsense-mediated mRNA decay (NMD) inhibition/escaping and activation strategies for cancer treatment

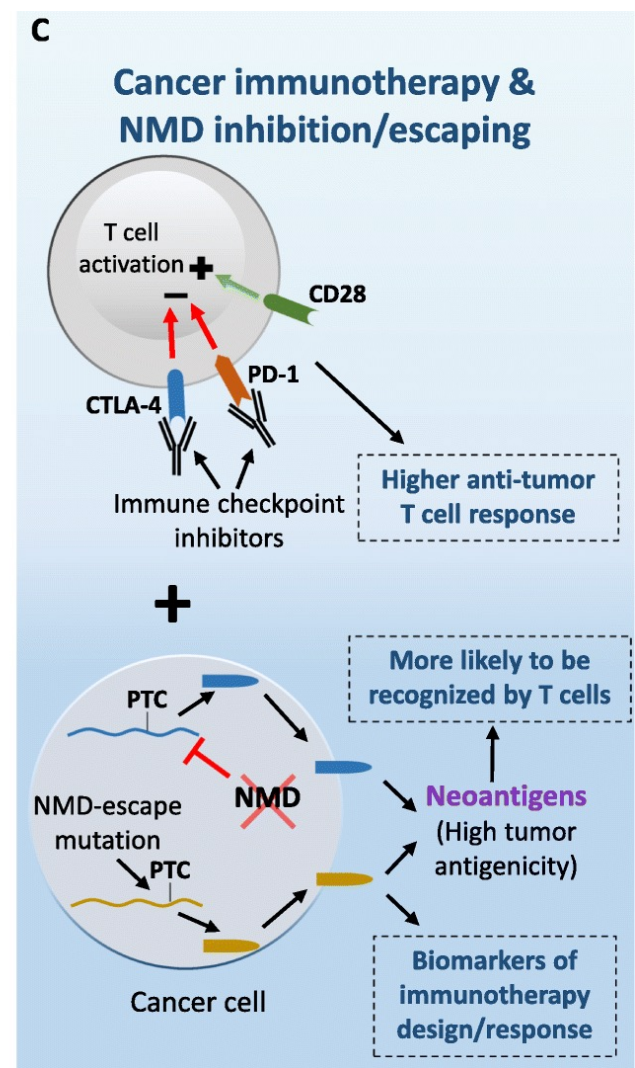
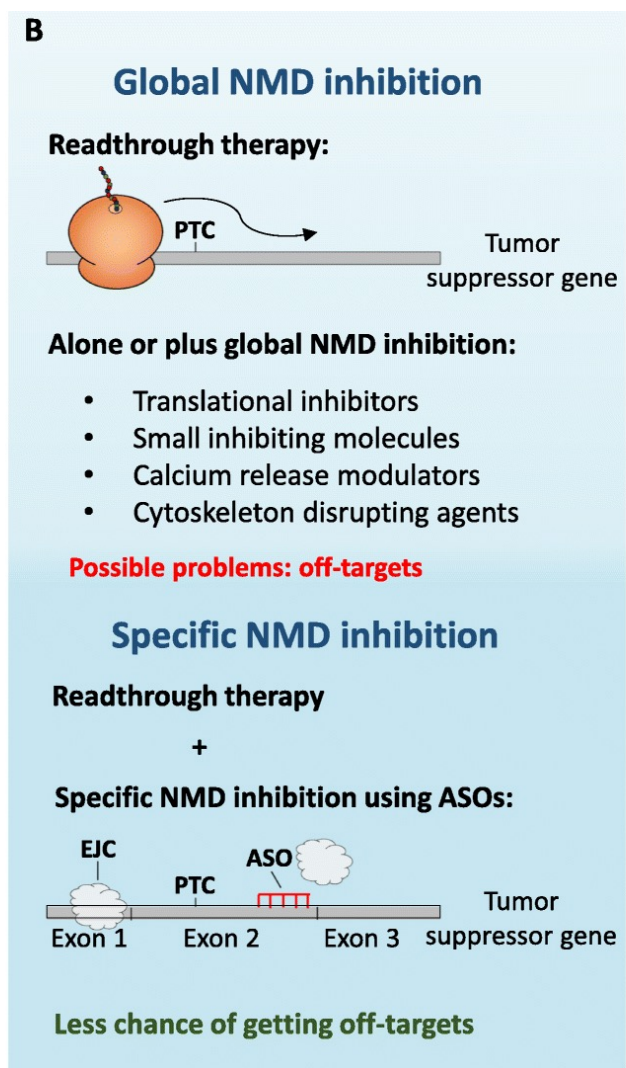
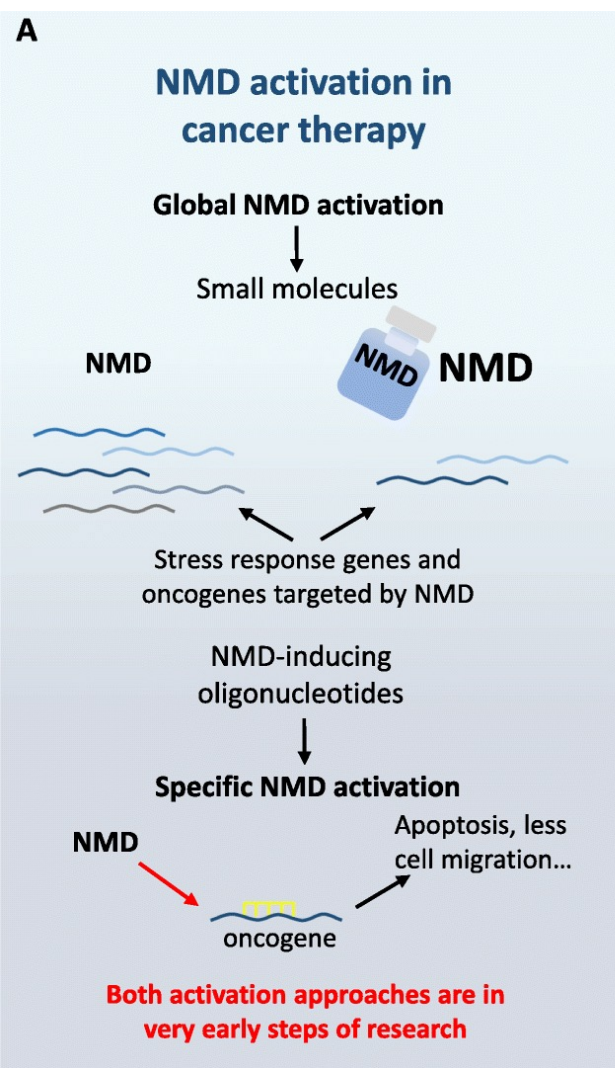

RNA quality control in the cytoplasm: ND

Nonstop decay

Nonstop decay (ND) targets mRNAs lacking an in-frame termination codon

Occurs by different mechanism than NMD, but is also translation dependent

ND requires the cytoplasmic exosome and the associated Ski complex

Independent of the decapping and deadenylation factors

Ski7 C-terminal domain binds to free A-site of ribosome, and recruits the exosome and the Ski complex

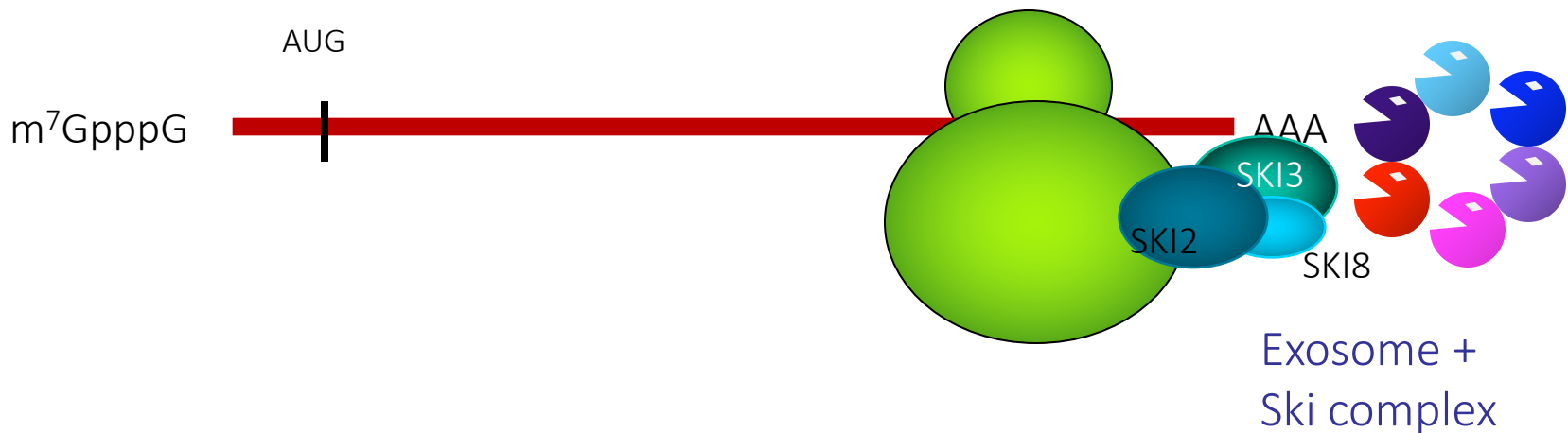

RNA quality control in the cytoplasm: NoGo

NoGo decay

What happens when ribosomes are stalled on mRNAs due to mRNA defects, or defects in ribosomes?

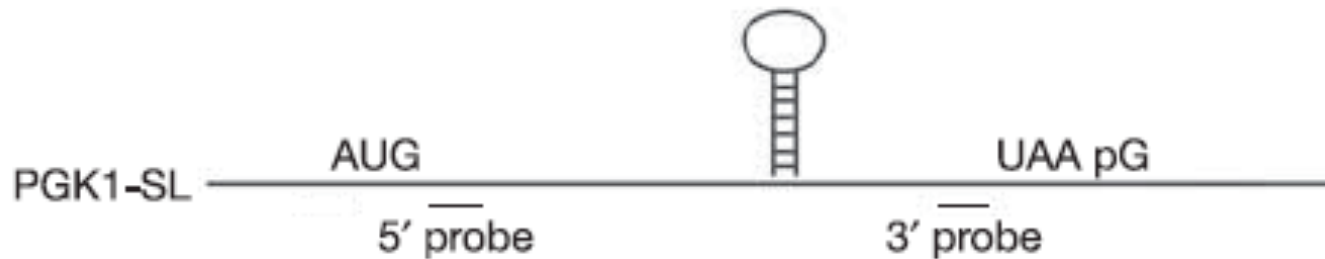

Doma & Parker, 2006

NoGo decay

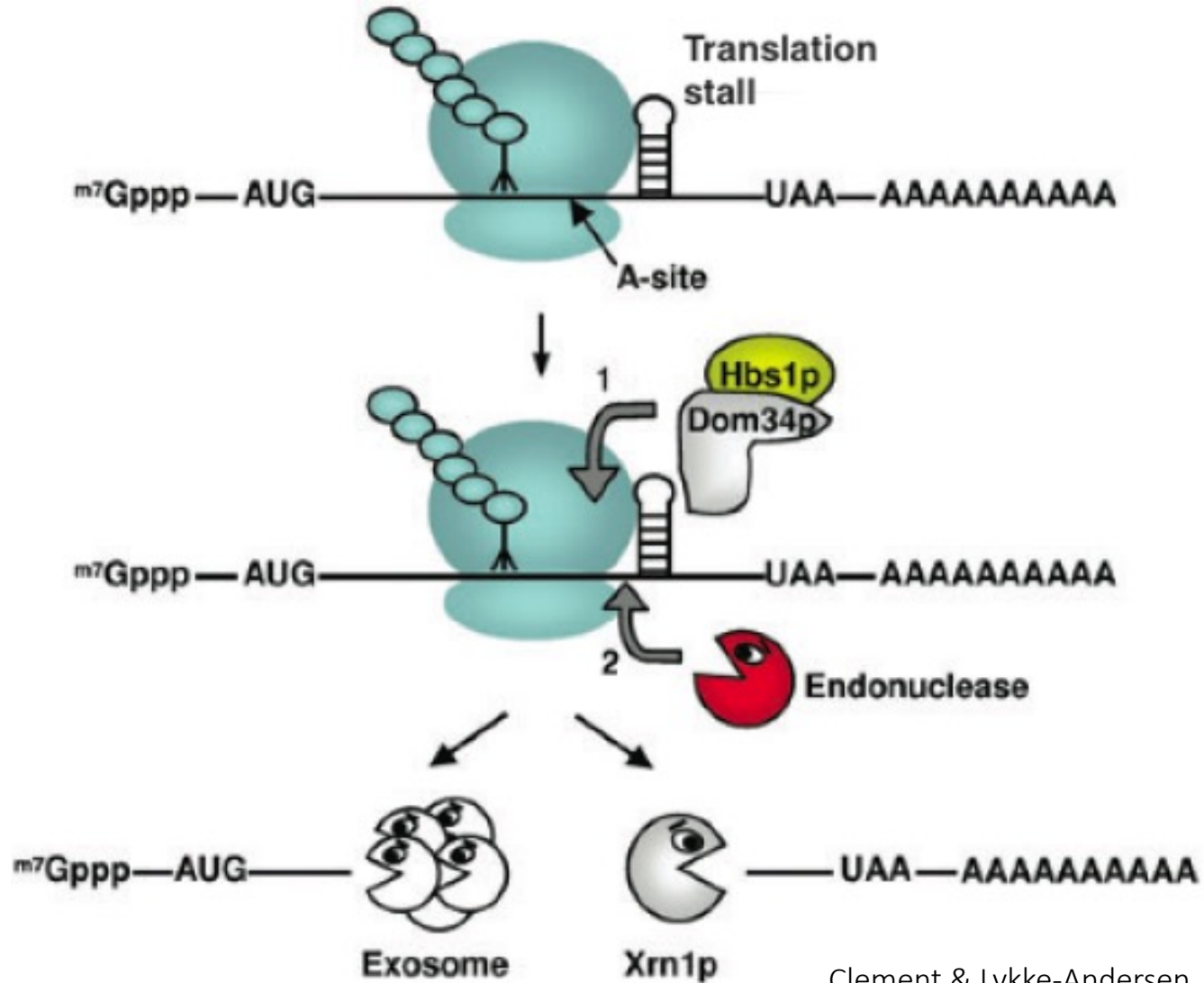

Clement & Lykke-Andersen, 2006

Doma & Parker, 2006

Summary of mRNA surveillance pathways in the cytoplasm

NMD

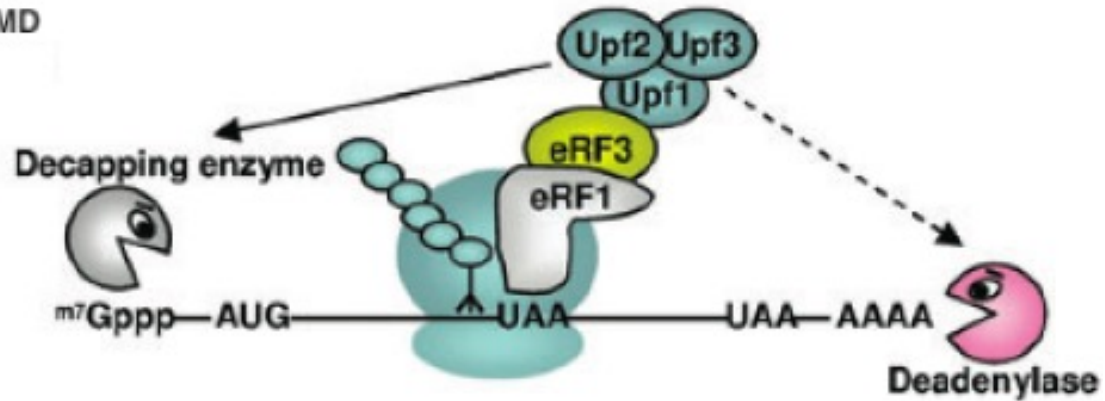

NSD

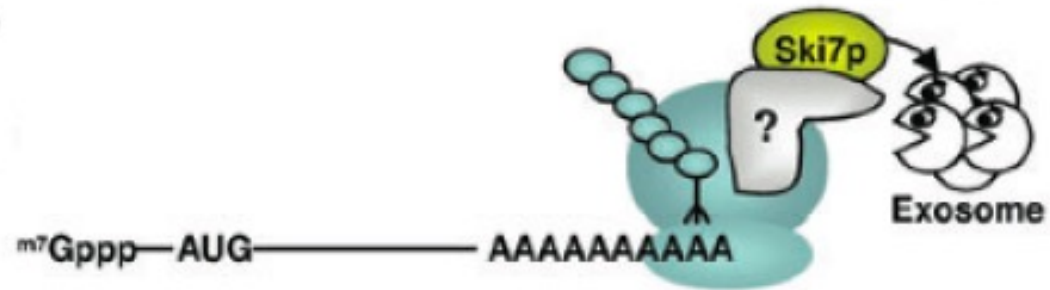

NGD

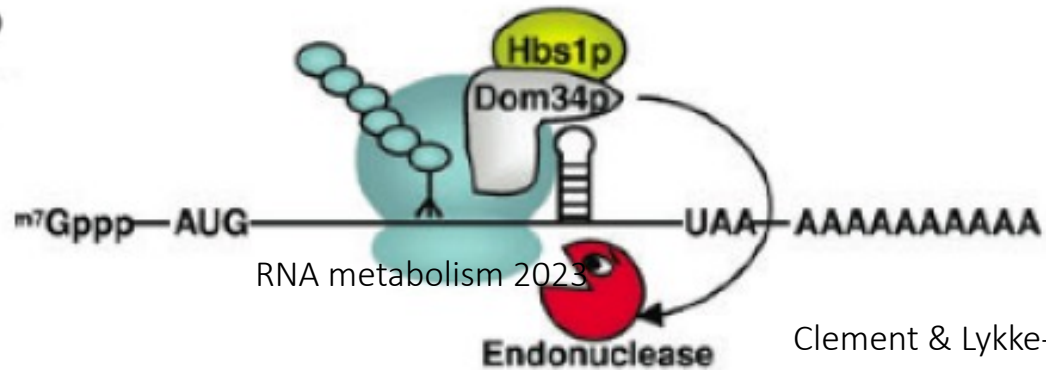

Summary of mRNA Surveillance Pathways

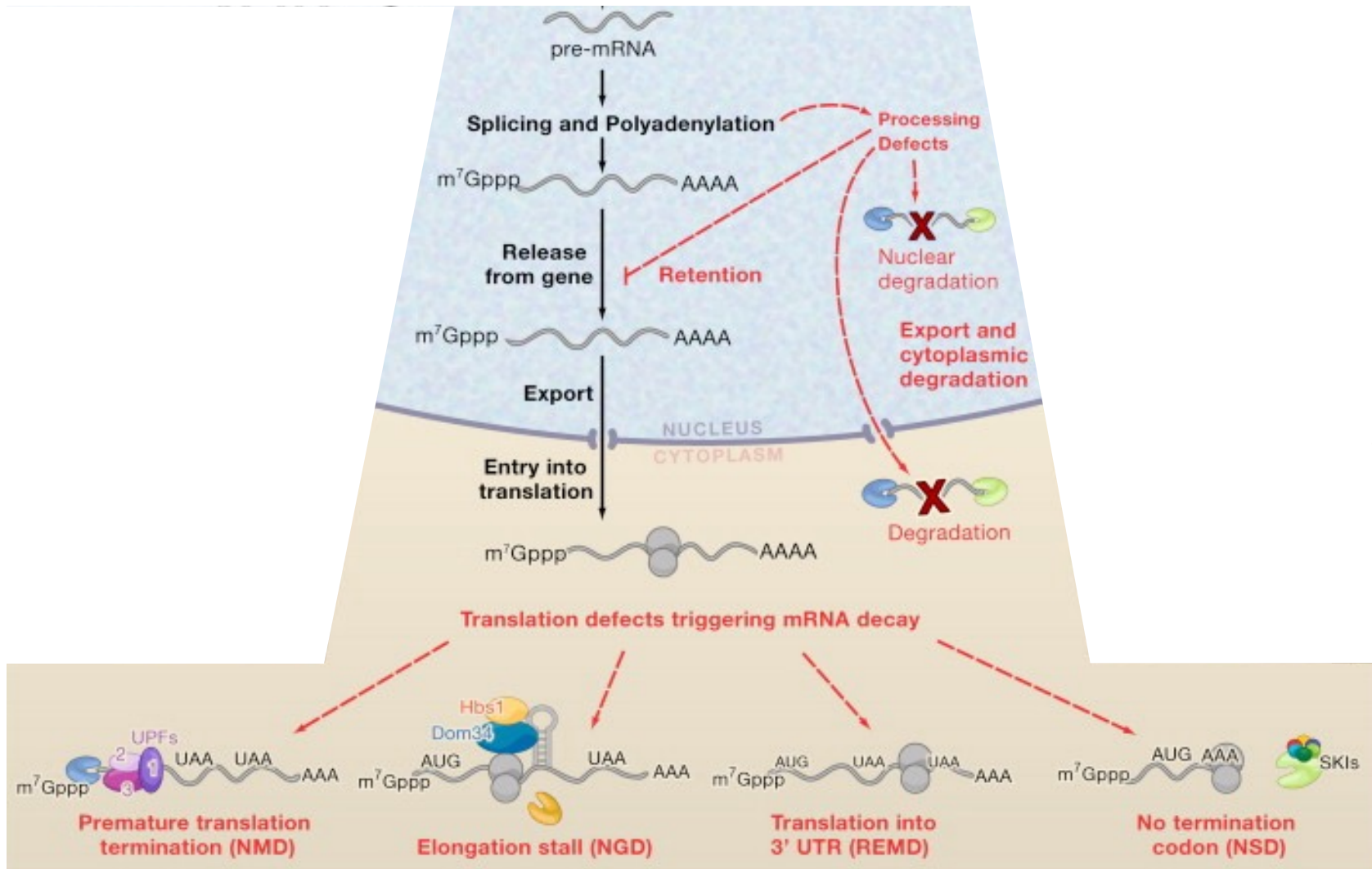

RNA quality control of noncoding RNAs

Nuclear RNA surveillance of noncoding RNAs

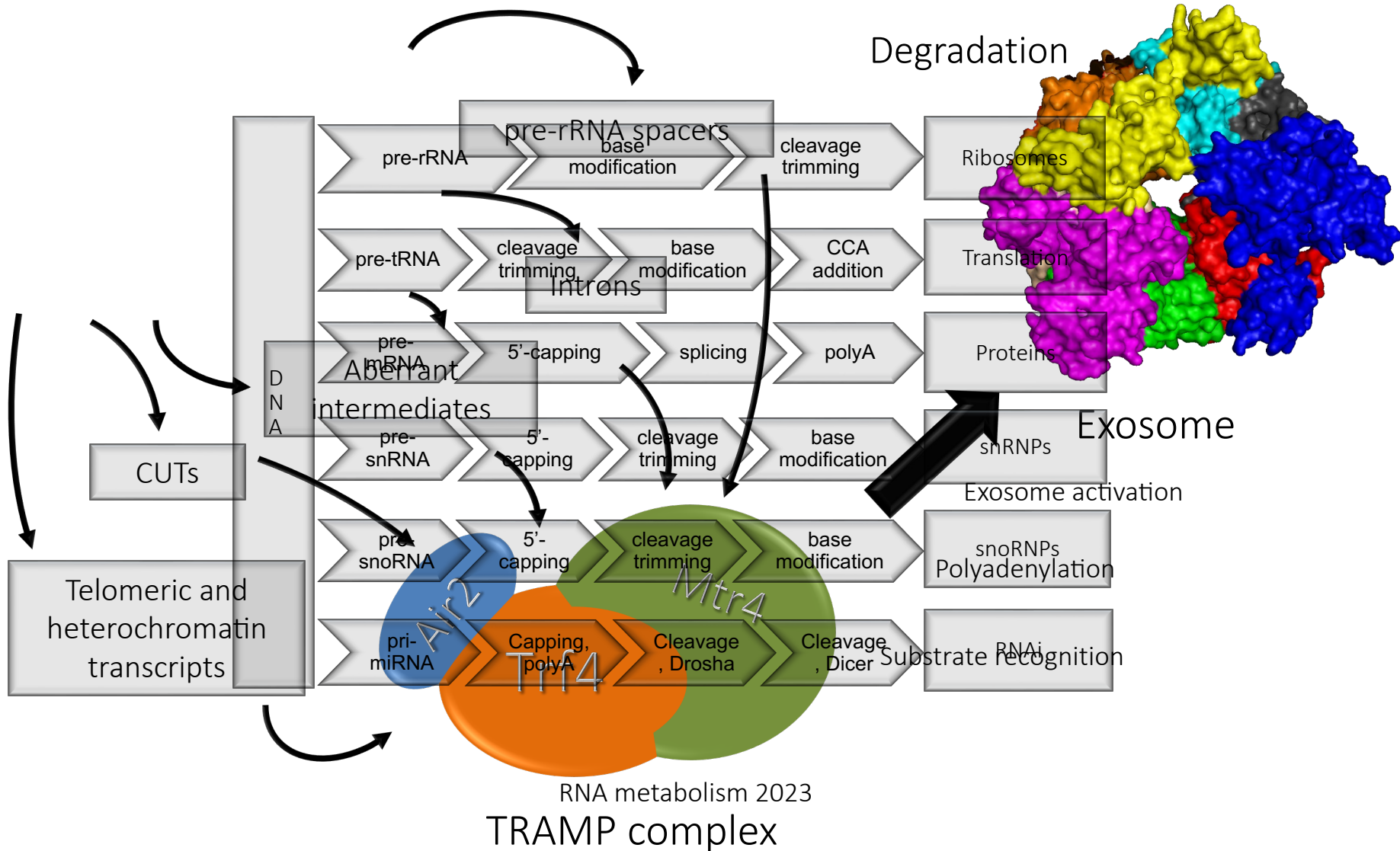

Polyadenylation mediates surveillance of ncRNAs in the nucleus

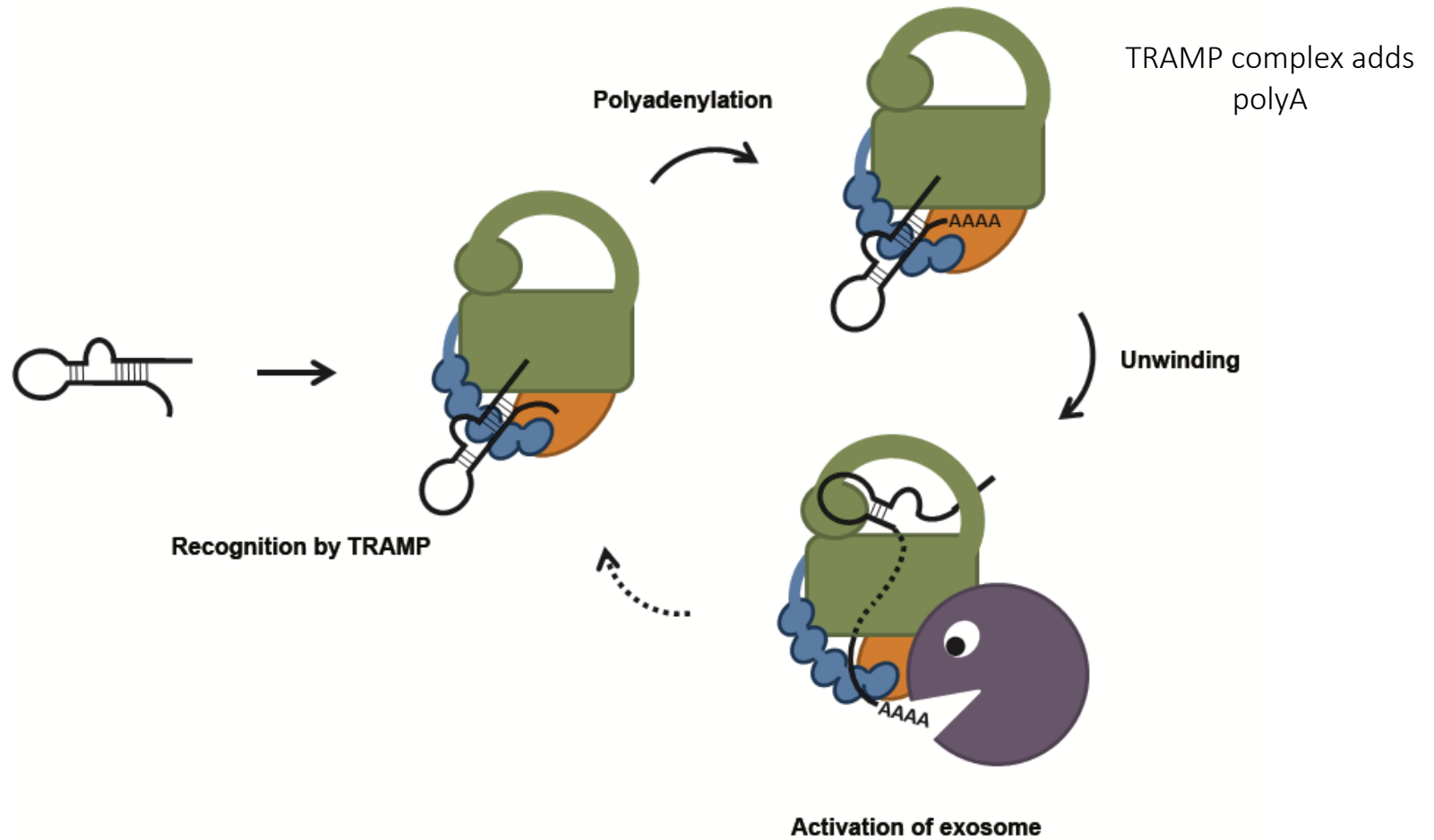

RNA tagging for degradation

NUCLEUS

CYTOPLASM

Polyadenylation-mediated RNA degradation

Uridylation-mediated RNA degradation

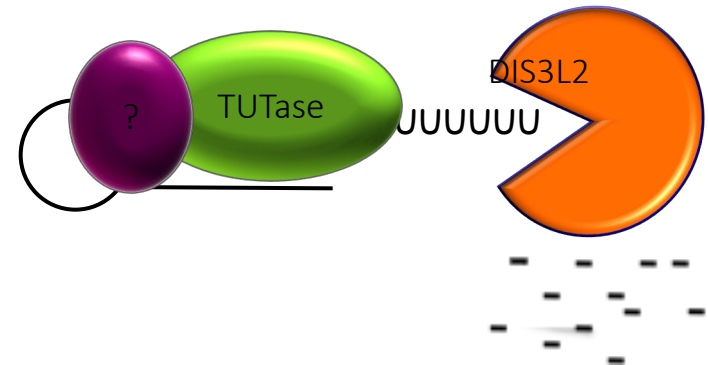
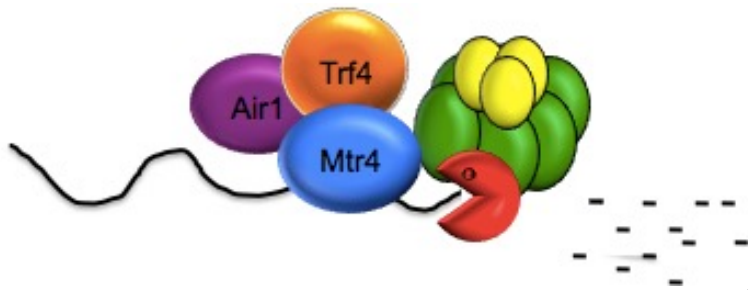

TRAMP + DIS3-EXOSOME

TUTase + DIS3L2

RNA surveillance of noncoding RNAs in the cytoplasm

The domain organization of DIS3 proteins

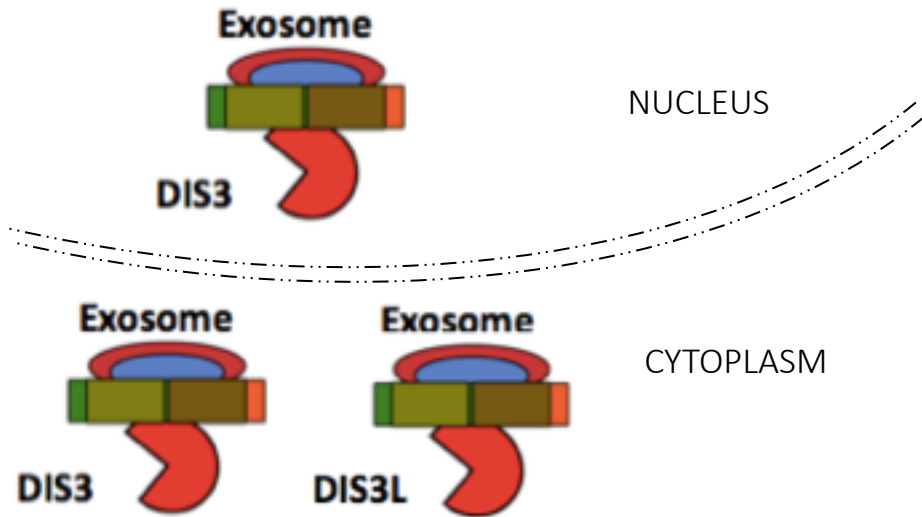
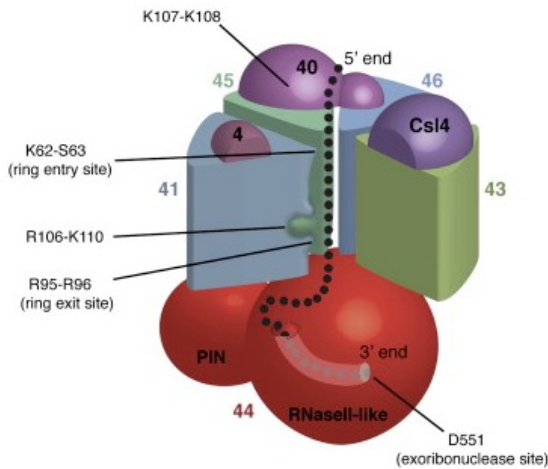
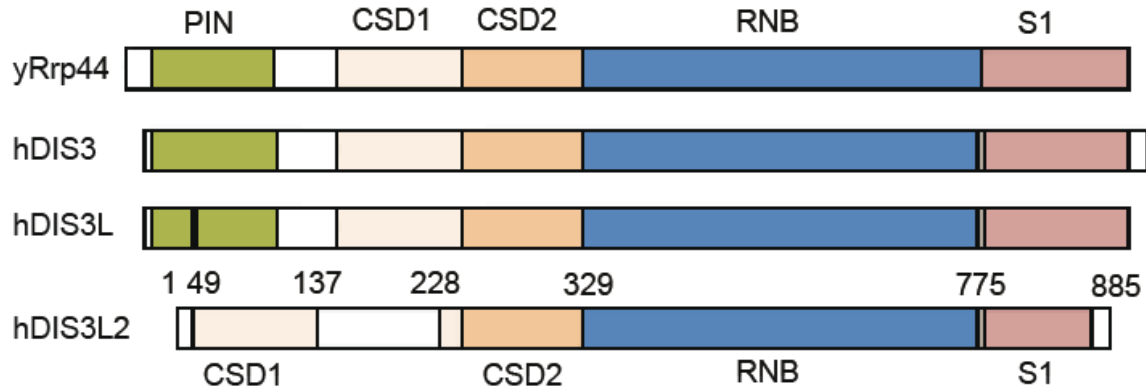

DIS3L2 degrades uridylated RNAs

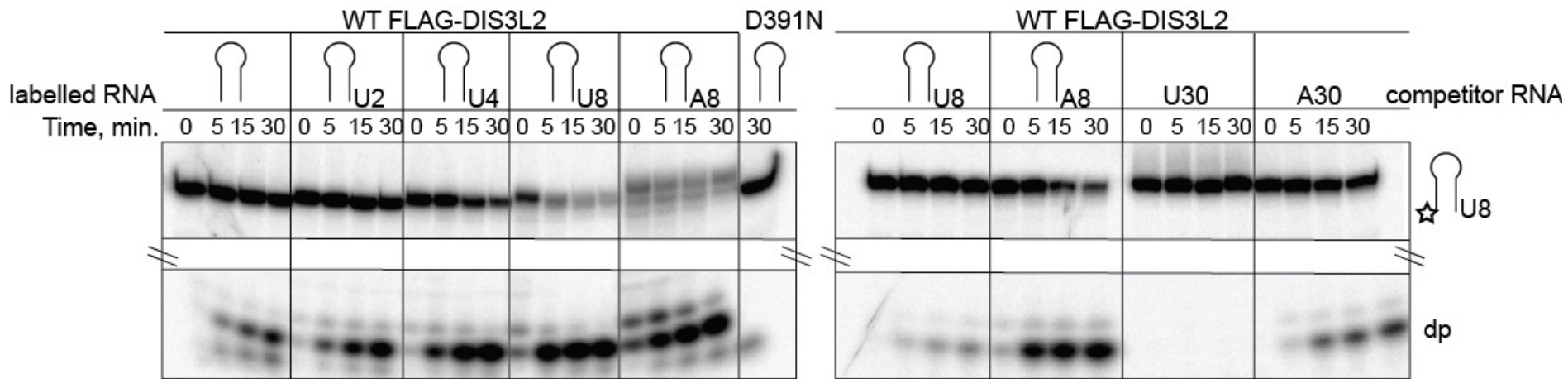
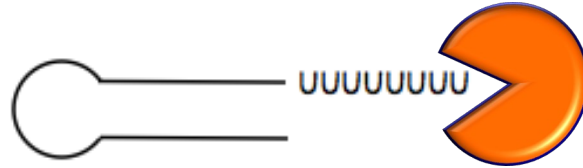

Ustianenko et al., 2013

CLIP-seq approach to identify DIS3L2 targets

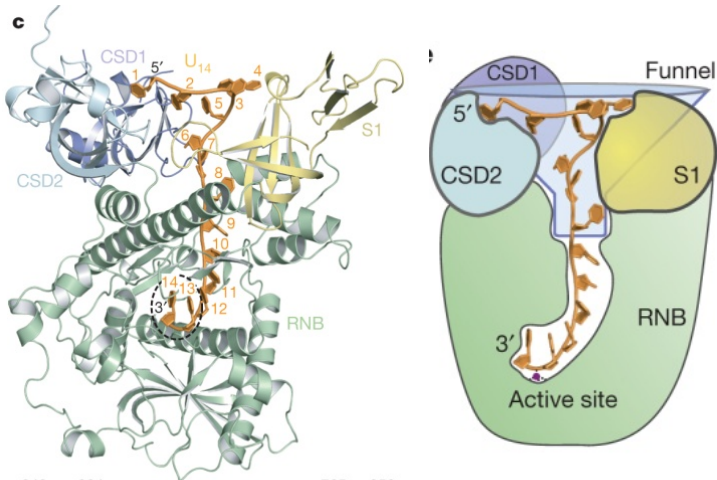

Faehnle et al., Nature 2014

In vivo crosslinking

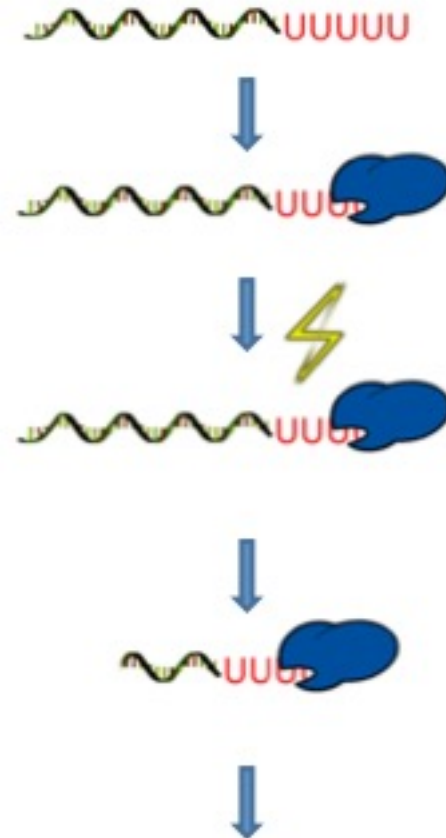

RNA metabolism 2023

The U-tail distribution on DIS3L2 bound RNAs

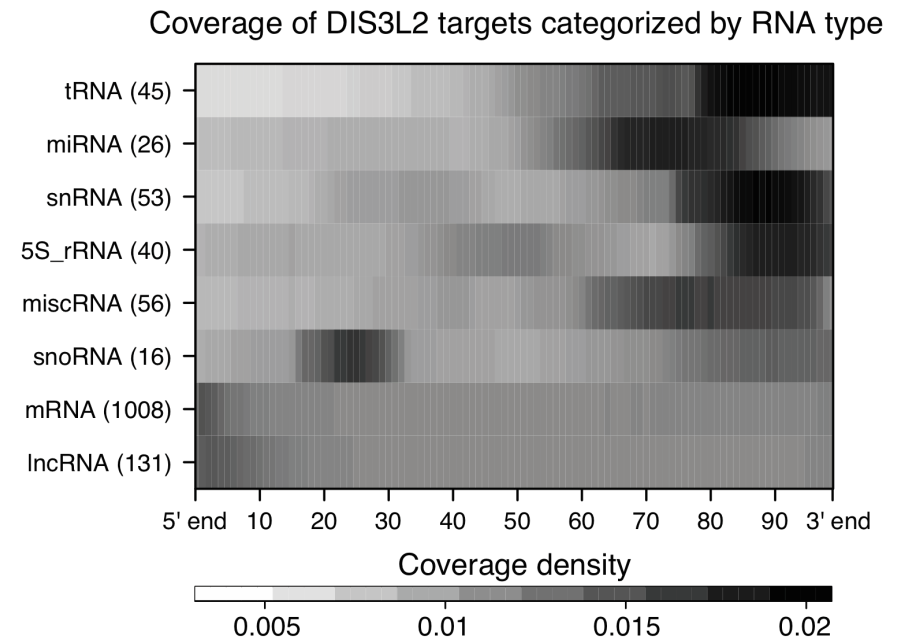
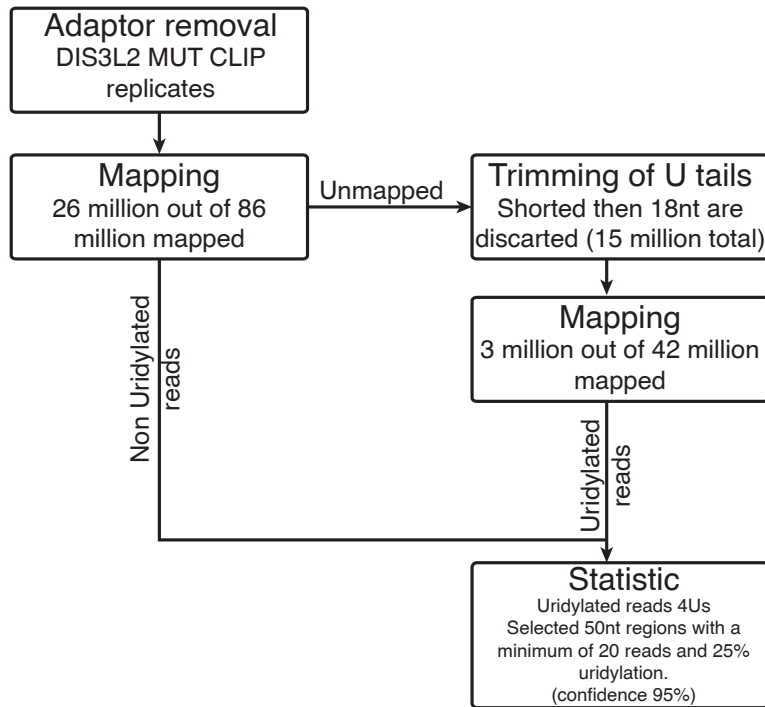

Missprocessed ncRNAs and transcripts from pseudogenes are uridylylated

RNA type	Genes	Pseudogenes
snRNA	55	48
snoRNA	17	1
5S rRNA	43	43
Vault RNA	3	0
Y RNA	47	13
7SL RNA	6	5
RNAseP	1	0
mtRNAseP	1	0

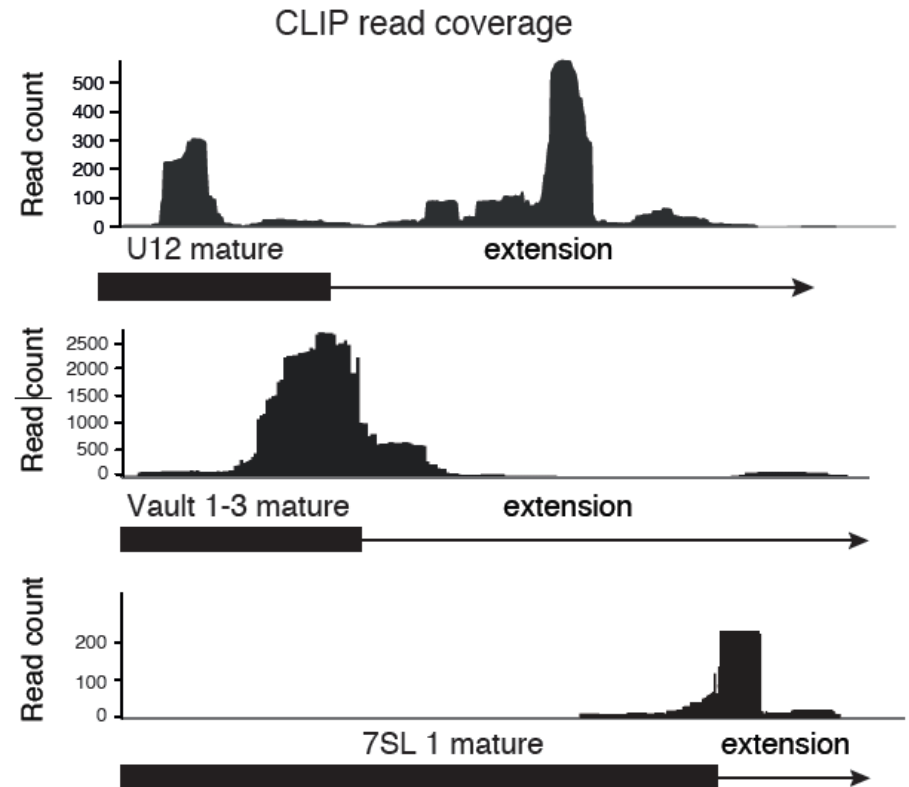

TDS = TUT-DIS3L2 surveillance of ncRNAs in the cytoplasm

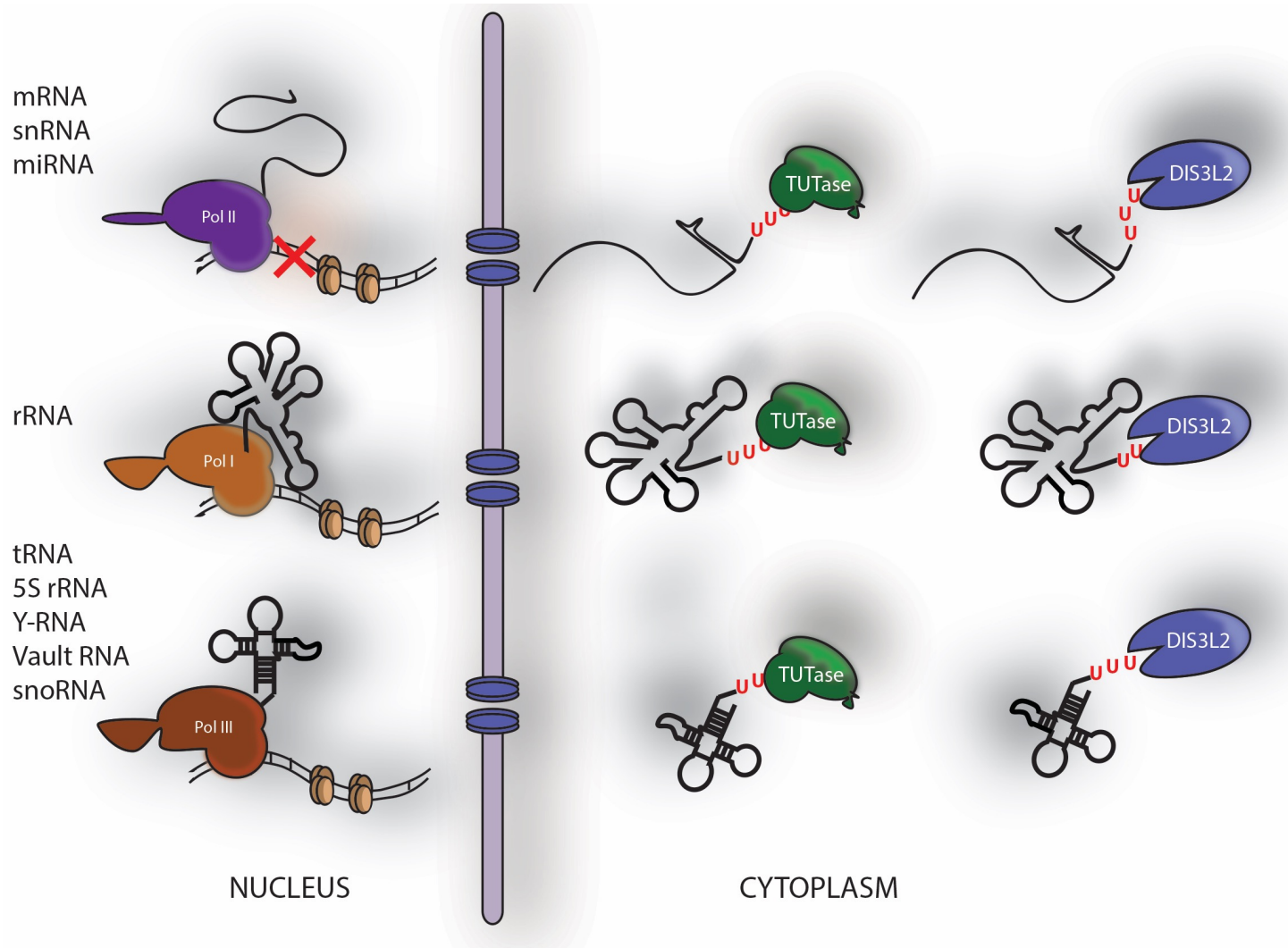

Lecture overview

1. General mRNA turnover pathways

- 5' → 3' & 3' → 5'
- Deadenylases
- Decapping complex
- Xrn1, exosome, DcpS

2. Aberrant RNA turnover pathways

- Premature stop codons: nonsense-mediated mRNA decay (NMD)
- No stop codons: non-stop mRNA decay (NSD)
- Elongation stall: no-go mRNA decay (NGD)
- Translation into the 3' UTR: ribosome extension-mediated mRNA decay (REMD)

3. Specialized mRNA turnover pathways

- ARE-mediated mRNA turnover: AU-rich elements in the 3' UTR are bound by proteins that modulate the stability of mRNAs in response to regulatory signals

4. RNA surveillance of noncoding RNAs

- oligo(A) mediated RNA quality control in the nucleus
- oligo(U) mediated RNA surveillance in the cytoplasm