

STRUKTURA NUKLEOVÝCH KYSELIN

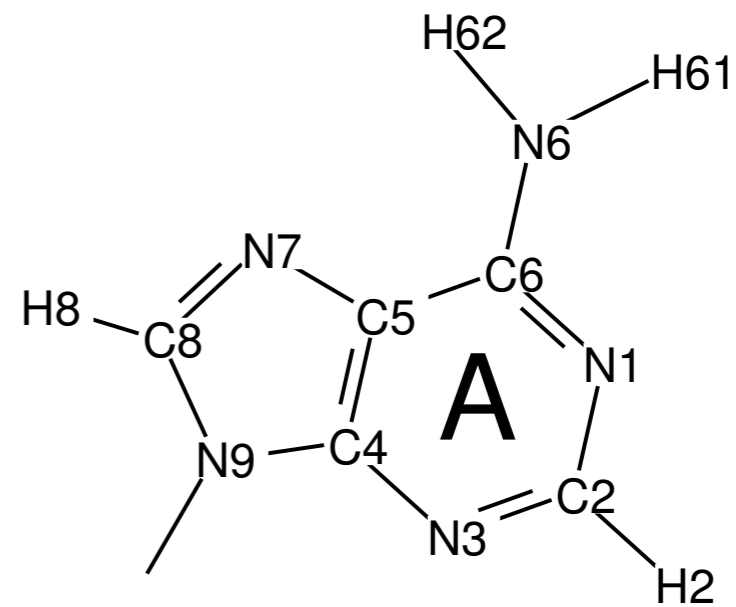

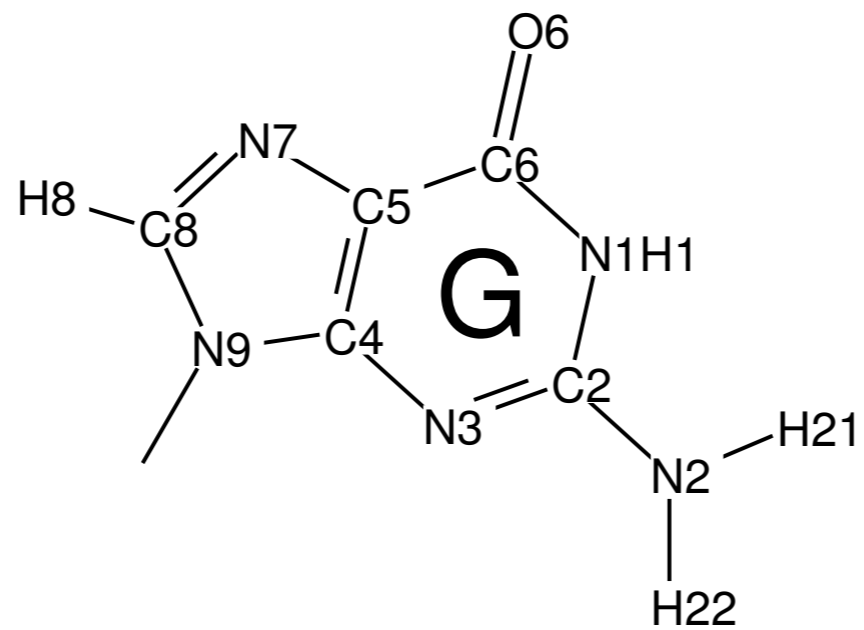

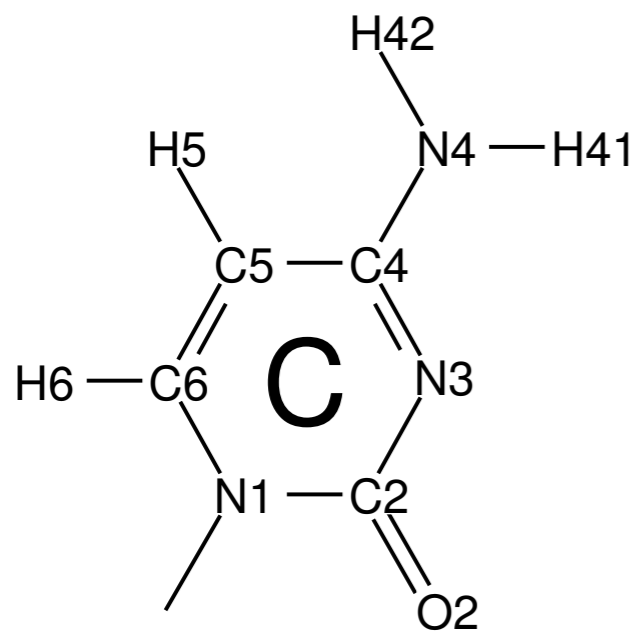

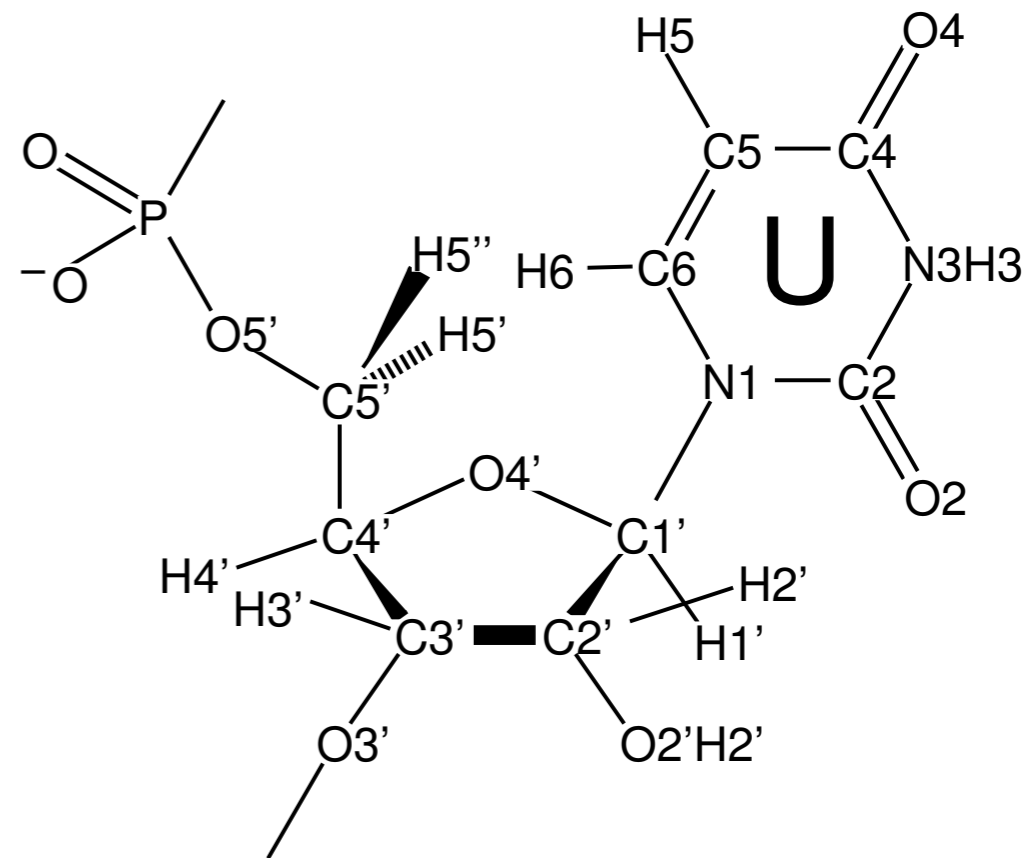
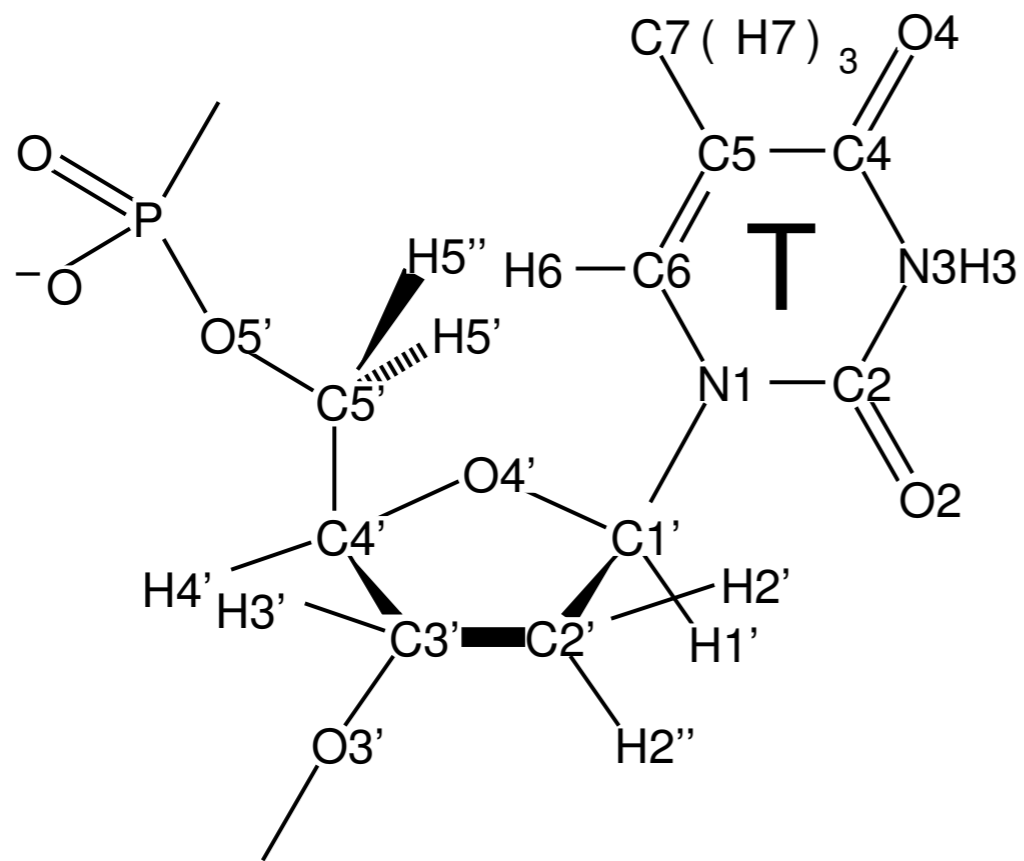
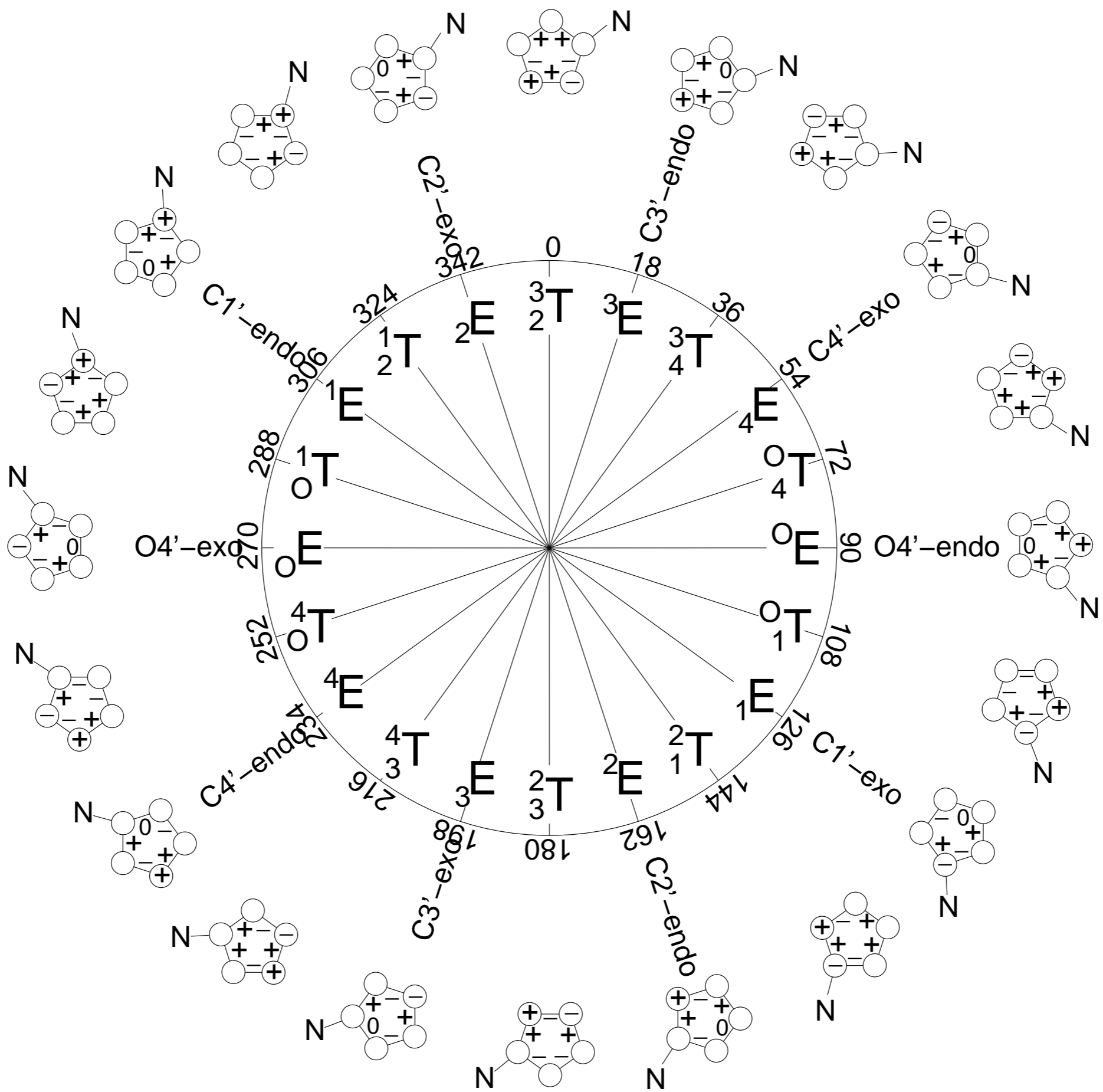
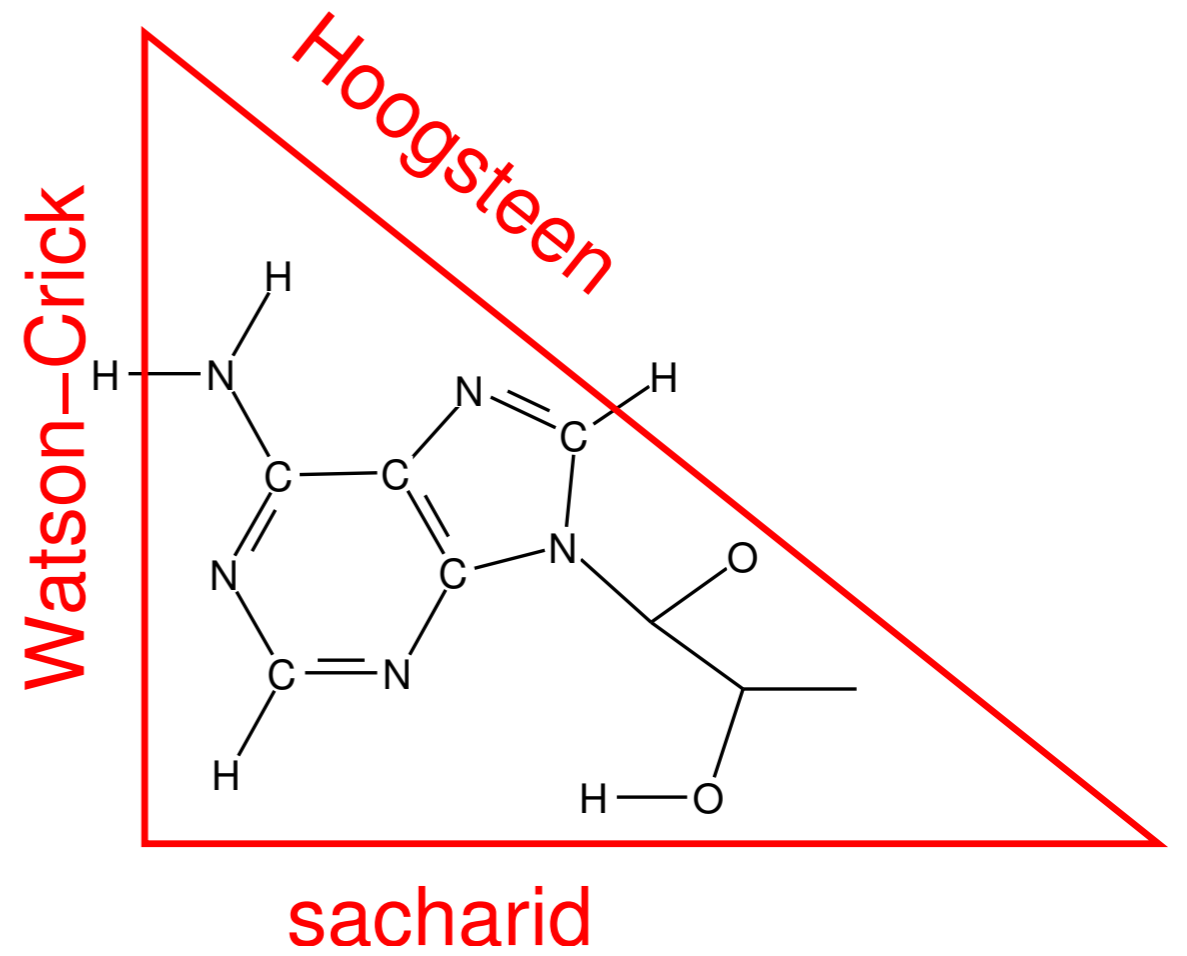
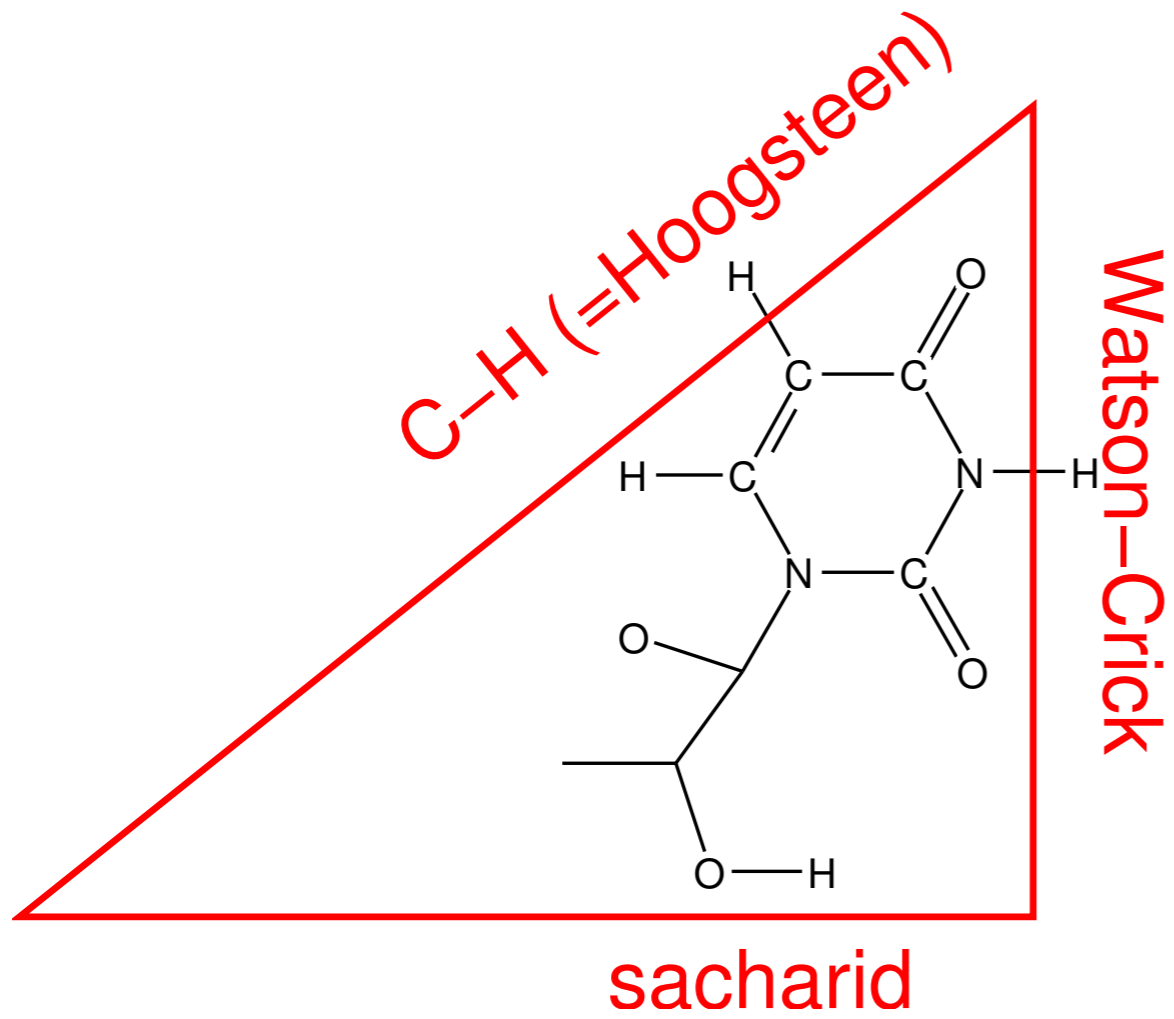
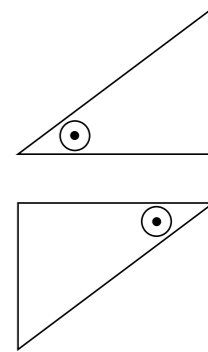
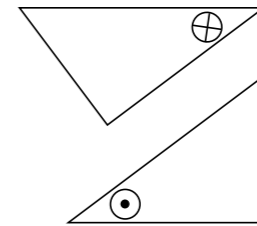
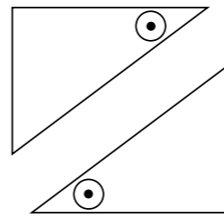
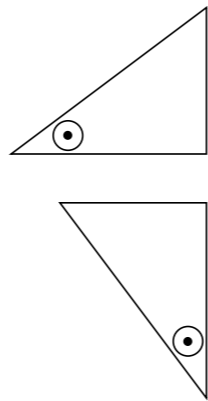
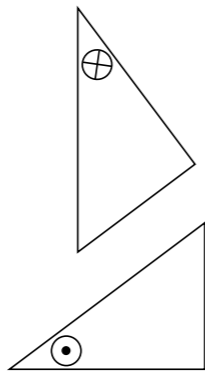
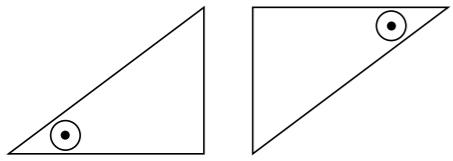
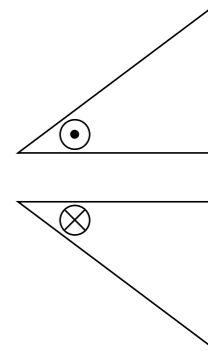
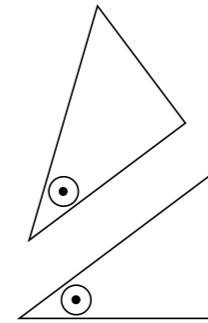
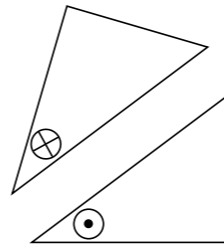
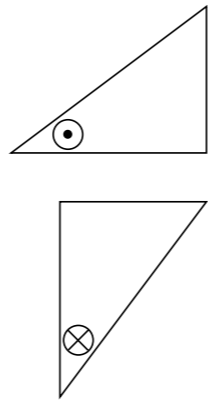
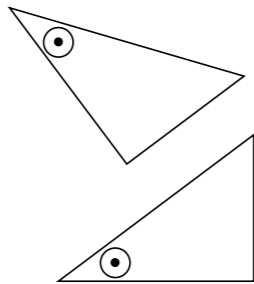
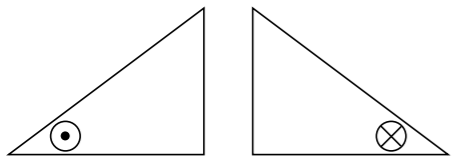

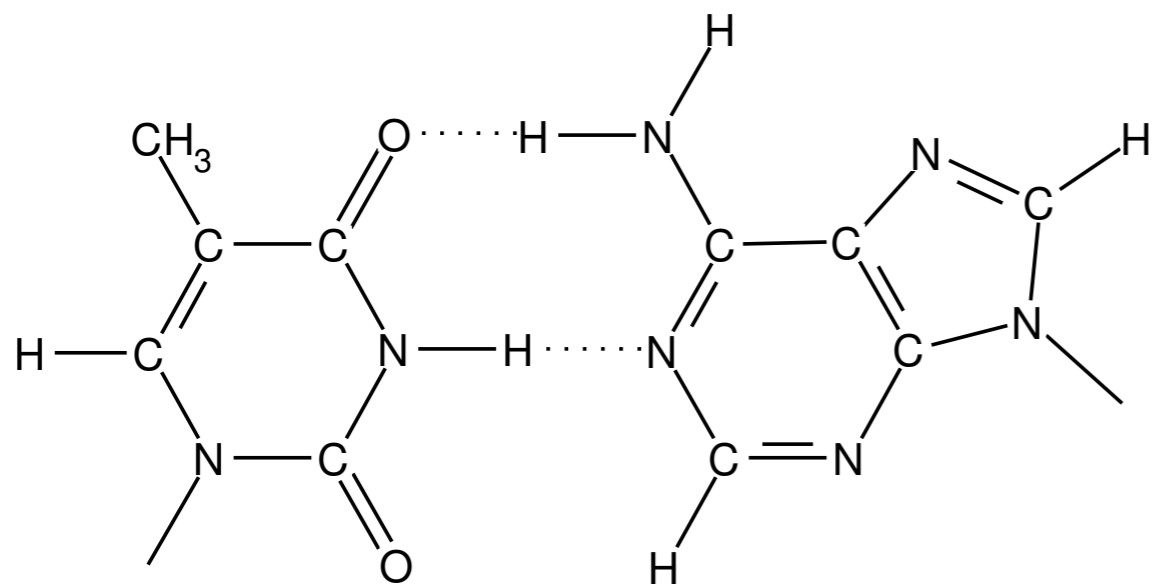

T - A

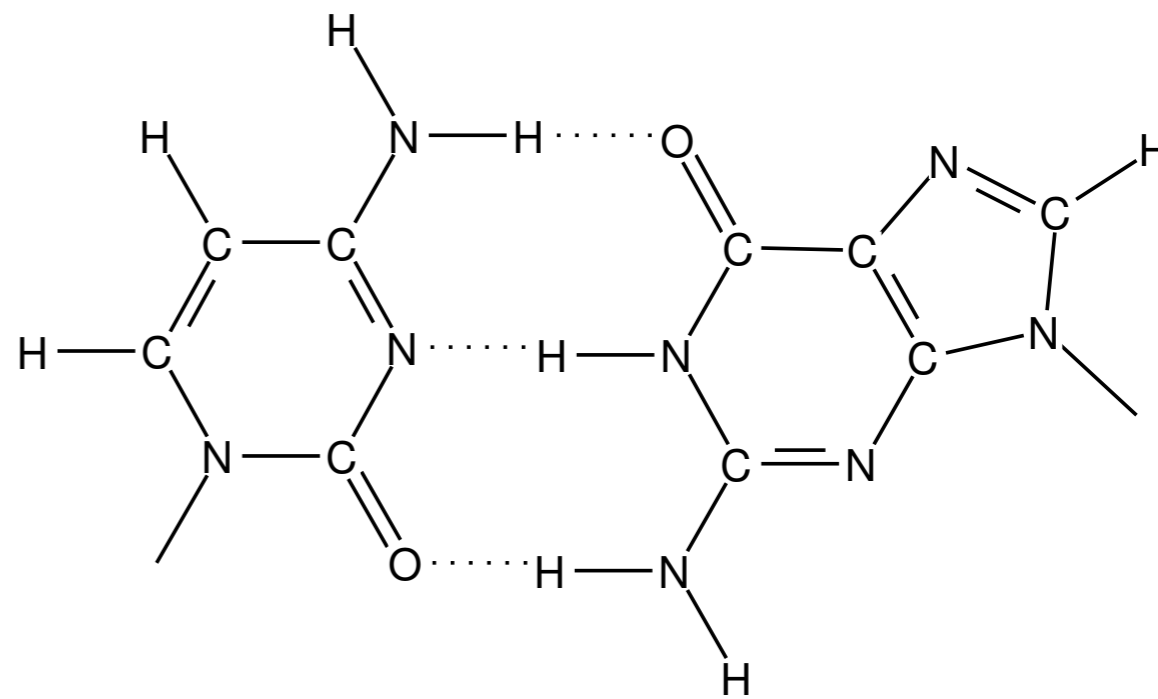

C = G

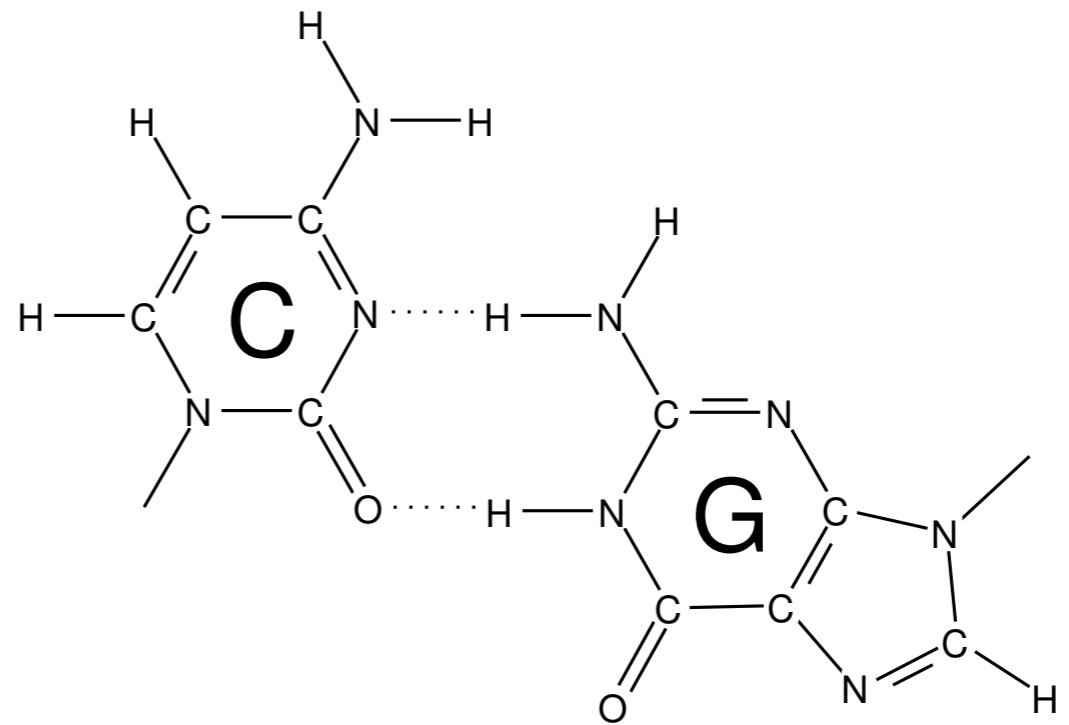
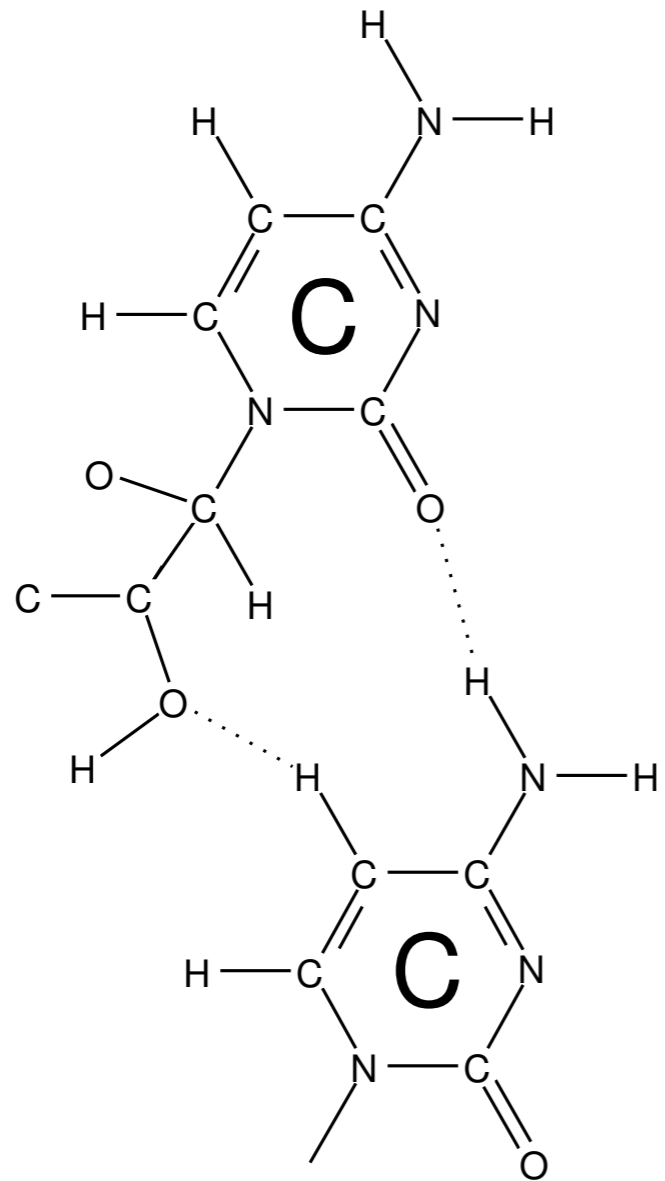
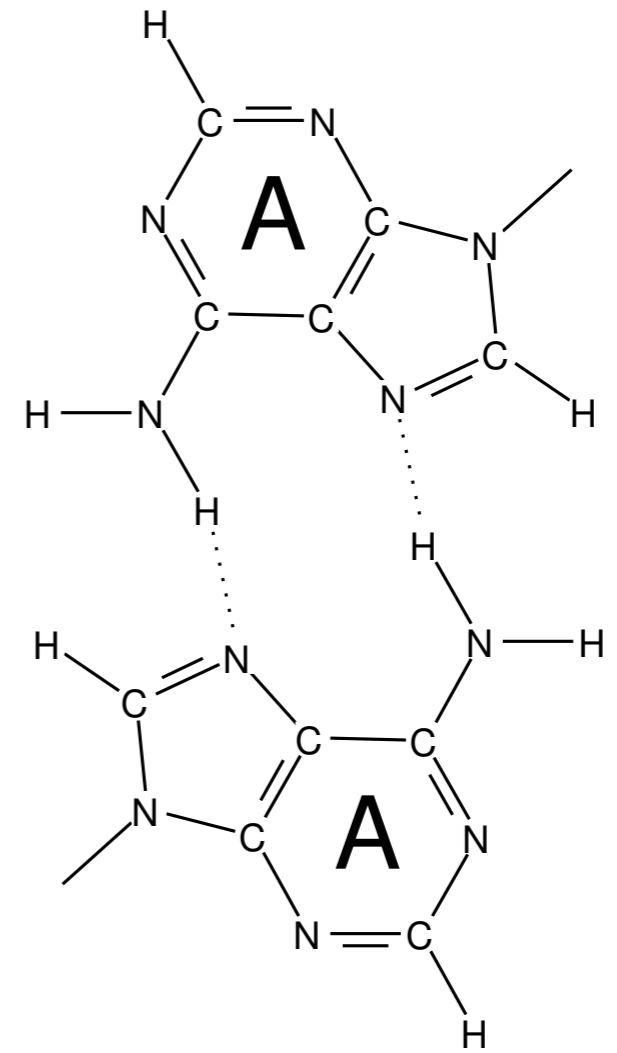
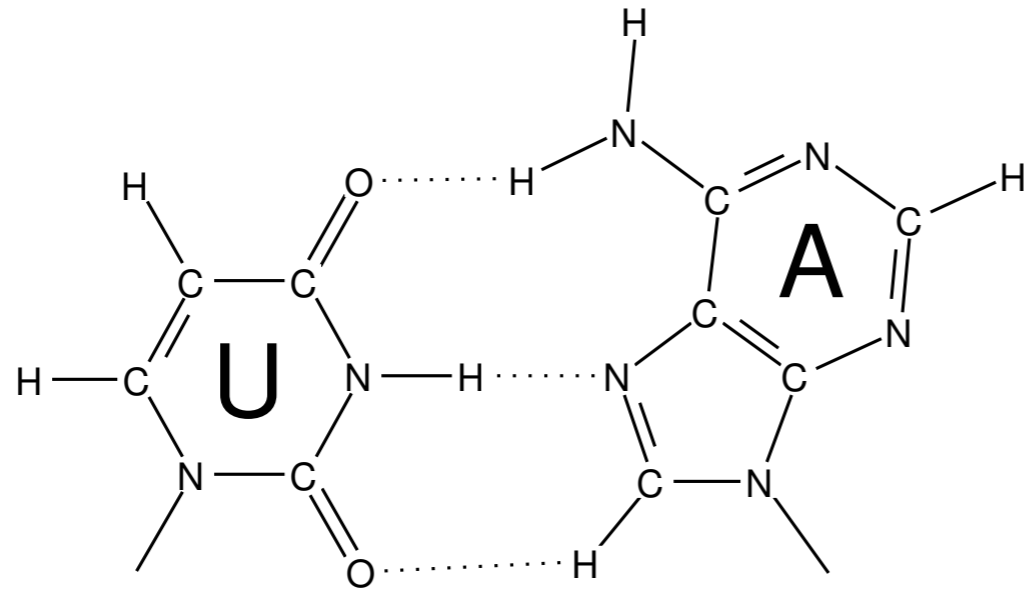

DNA, dvojšroubovice B

DNA, dvojšroubovice A

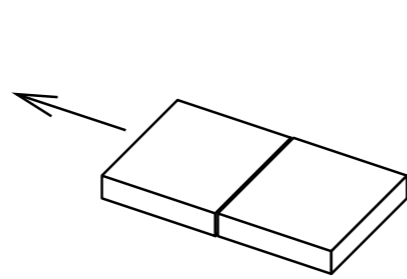
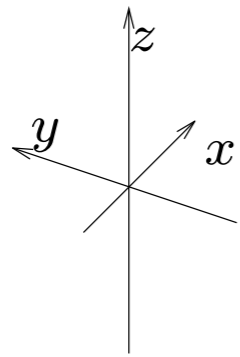

y-displacement (d_y)

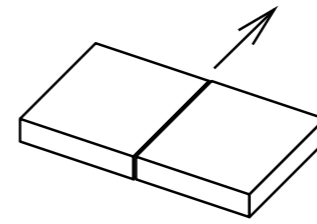

x-displacement (d_x)

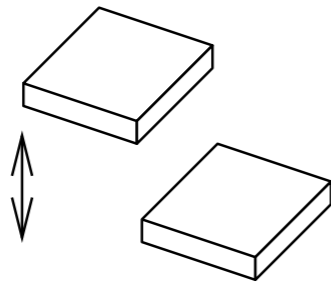

Stagger (S_z)

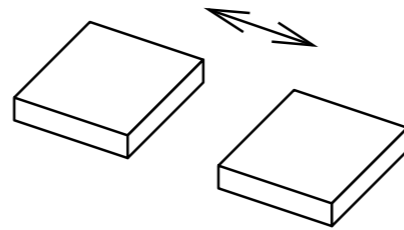

Stretch (S_y)

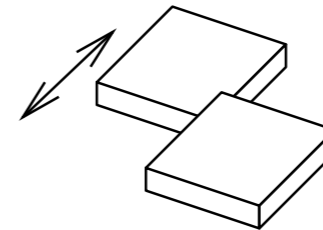

Shear (S_x)

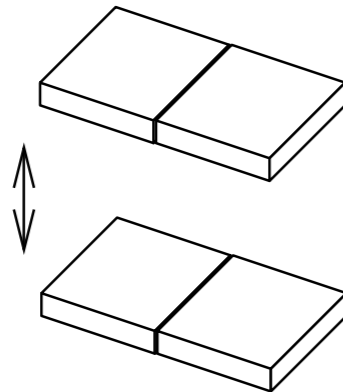

Rise (D_z)

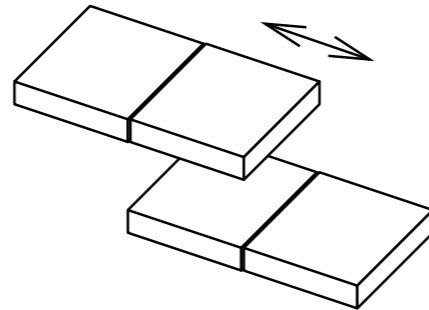

Slide (D_y)

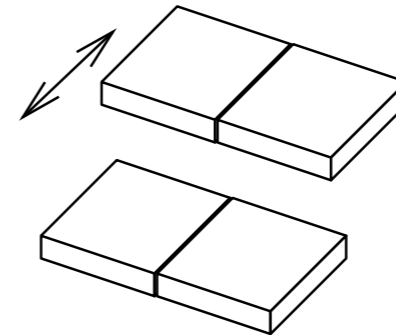

Shift (D_x)

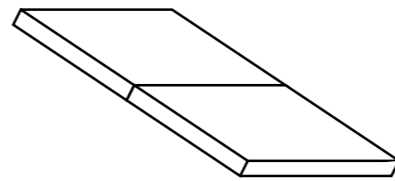
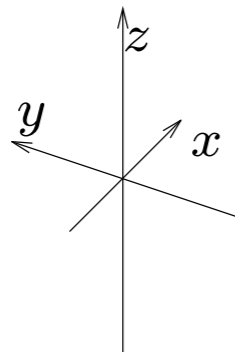

Tip (θ)

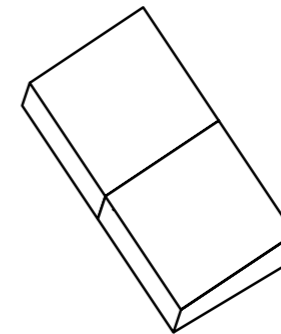

Inclination (η)

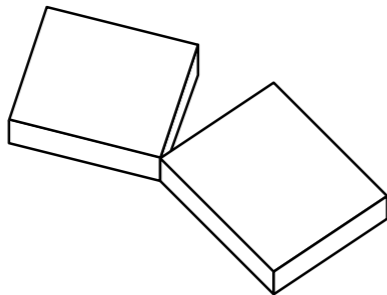

Opening (σ)

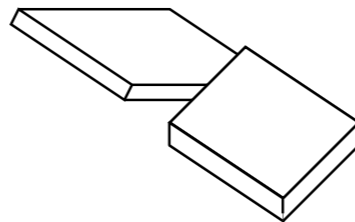

Propeller twist (ω)

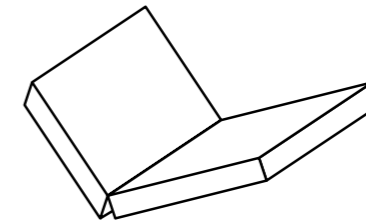

Buckle (κ)

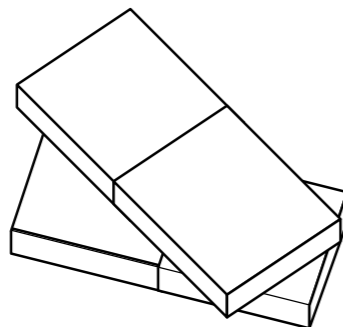

Twist (Ω)

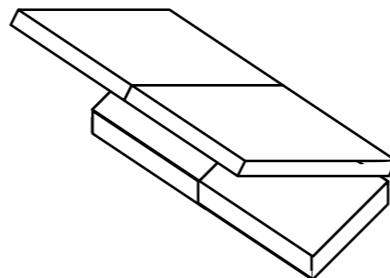

Roll (ρ)

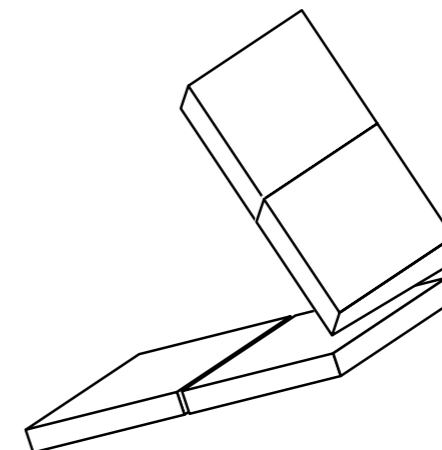

Tilt (τ)

