

F1190 Úvod do biofyziky

Podzimní semestr 2021

**Doc. Mgr. Karel Kubíček, Ph.D., Ústav fyziky kondenzovaných látek,
CEITEC MU, karelk@mail.muni.cz, +420 549 49 3253**

Buňky

- 1) Rozdělení
- 2) Uchování informace a její čtení buňkou
- 3) Zobrazování buněk
- 4) Cytoskeleton
- 5) Ribozom
- 6) Nukleozom
- 7) Spliceosom
- 8) Buněčný cyklus
- 9) Apoptóza
- 10) Rakovina

Tvary a velikosti vybraných bakterií

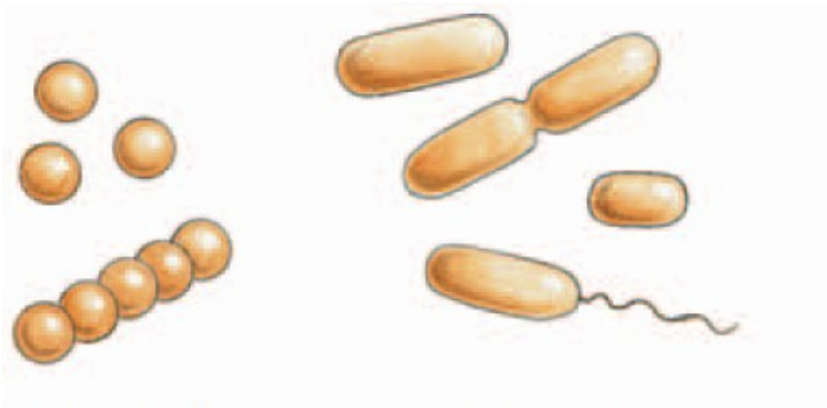

spherical cells
e.g., *Streptococcus*

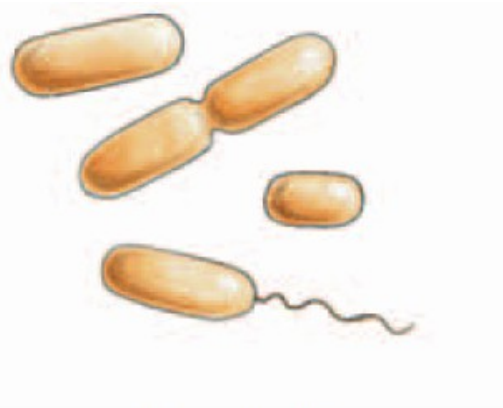

rod-shaped cells
e.g., *Escherichia coli*,
Vibrio cholerae



the smallest cells
e.g., *Mycoplasma*,
Spiroplasma

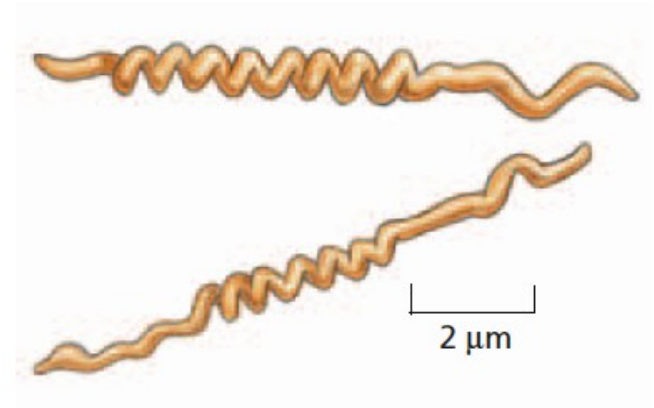

spiral cells
e.g., *Treponema pallidum*

Gram-**negativní** - bakterie NEREAGUJÍ s krystalovou violetí v Gramově protokolu

Gram-**pozitivní** – bakterie, které ZŮSTANOU tmavě modré/fialové po reakci s krystalovou violetí

- 1) Smíchání krystalové violeti s bakteriální kulturou za horka
- 2) Přidání iodidu
- 3) Odbarvení alkoholem nebo acetonem
- 4) Přidání safraninu/fuchsínu

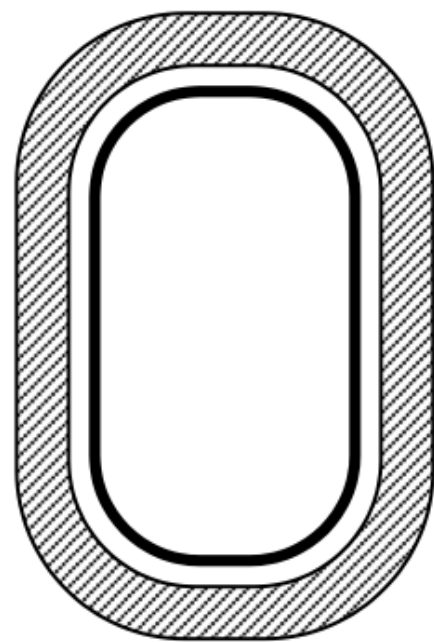
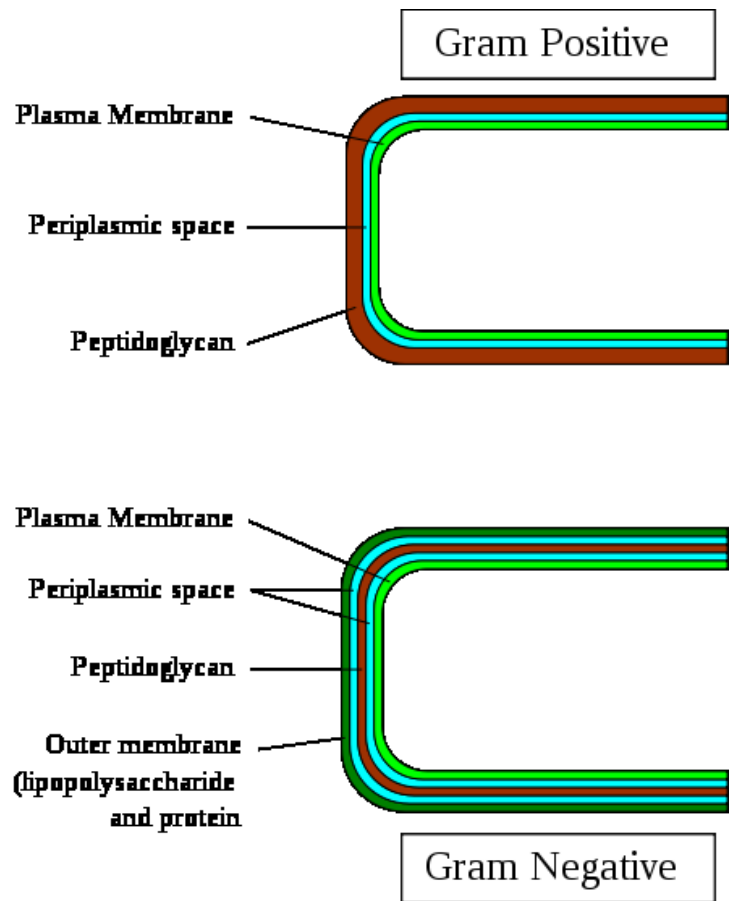

Gram - positive

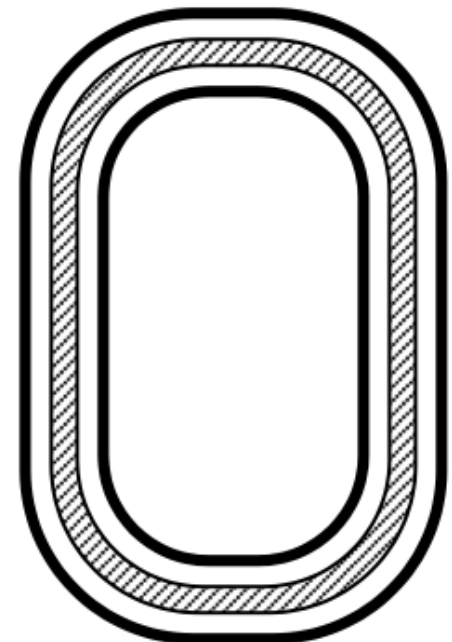

Gram - negative

Základní rozdělení živého světa

- 1) Prokaryoty
- 2) Eukaryoty

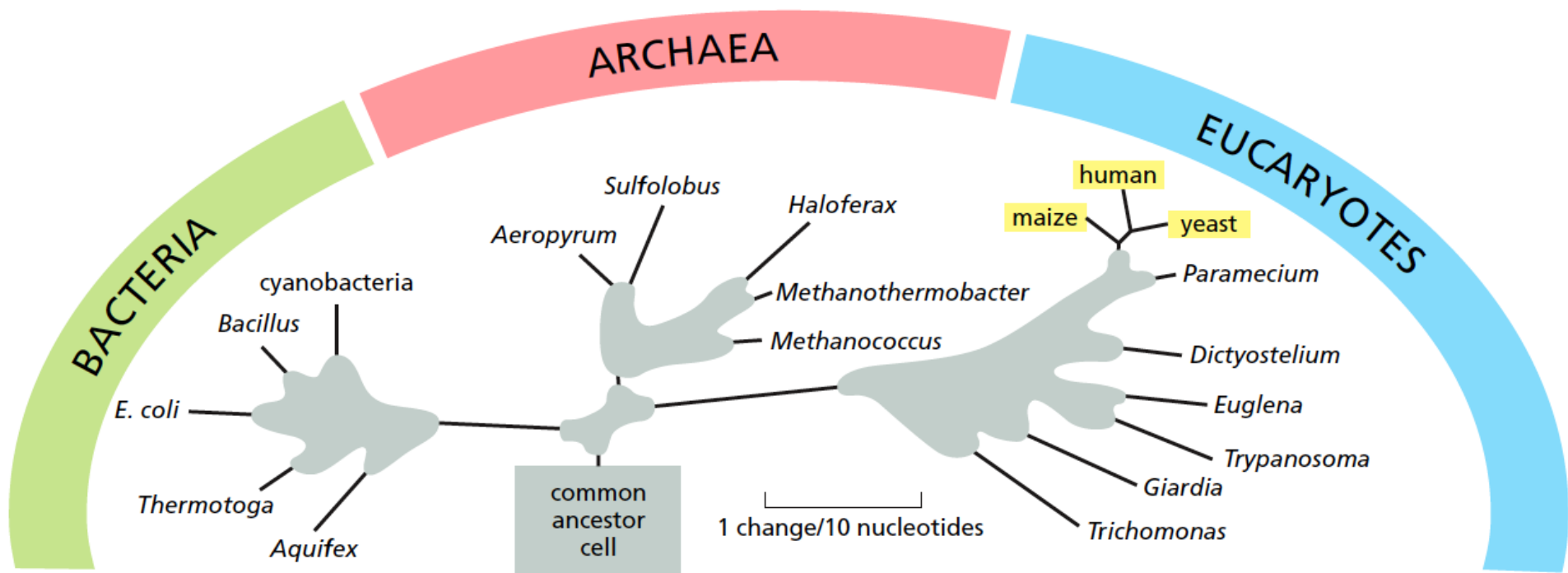

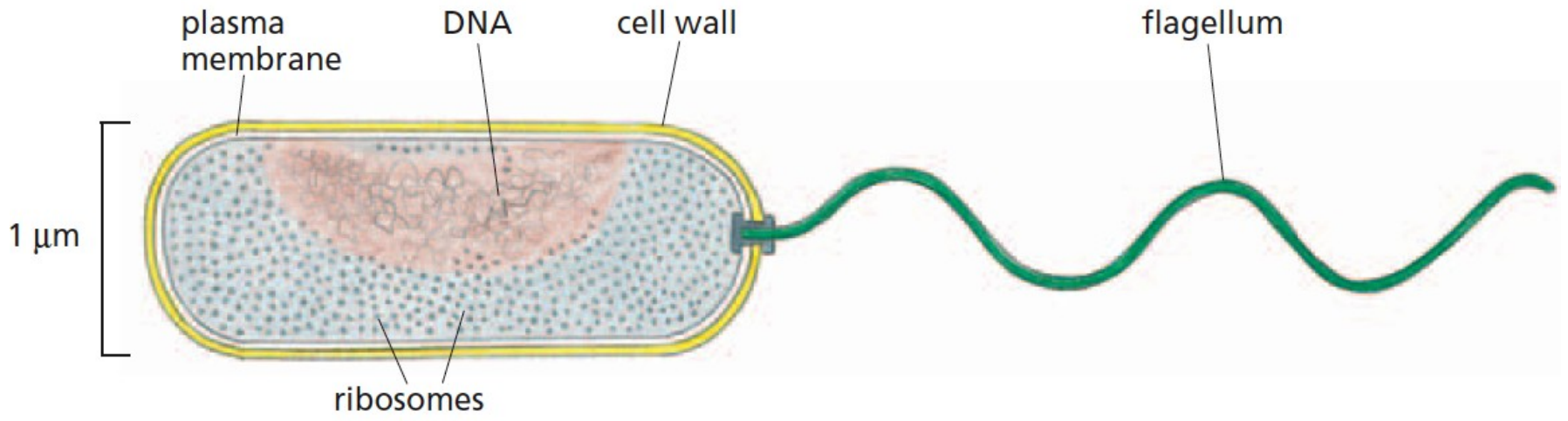

Vibrio cholerae

Escherischia coli (E.coli)

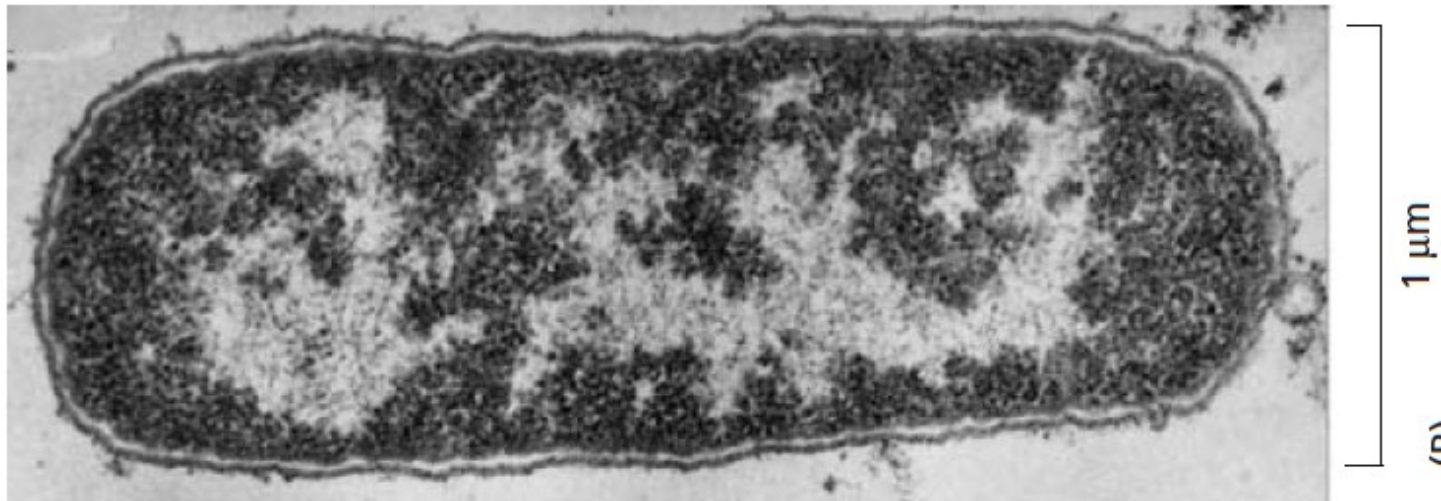

Eukaryotická buňka

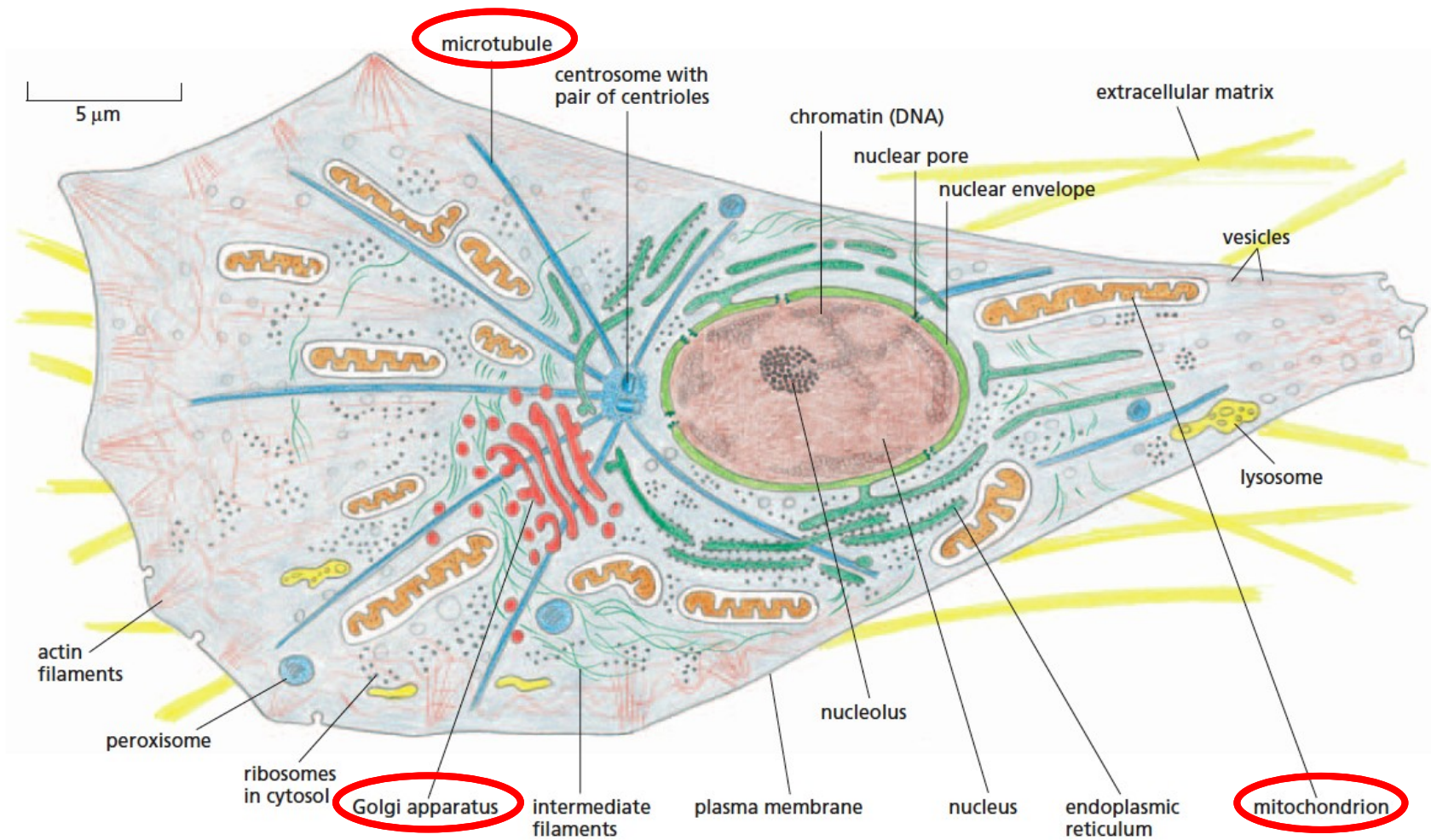

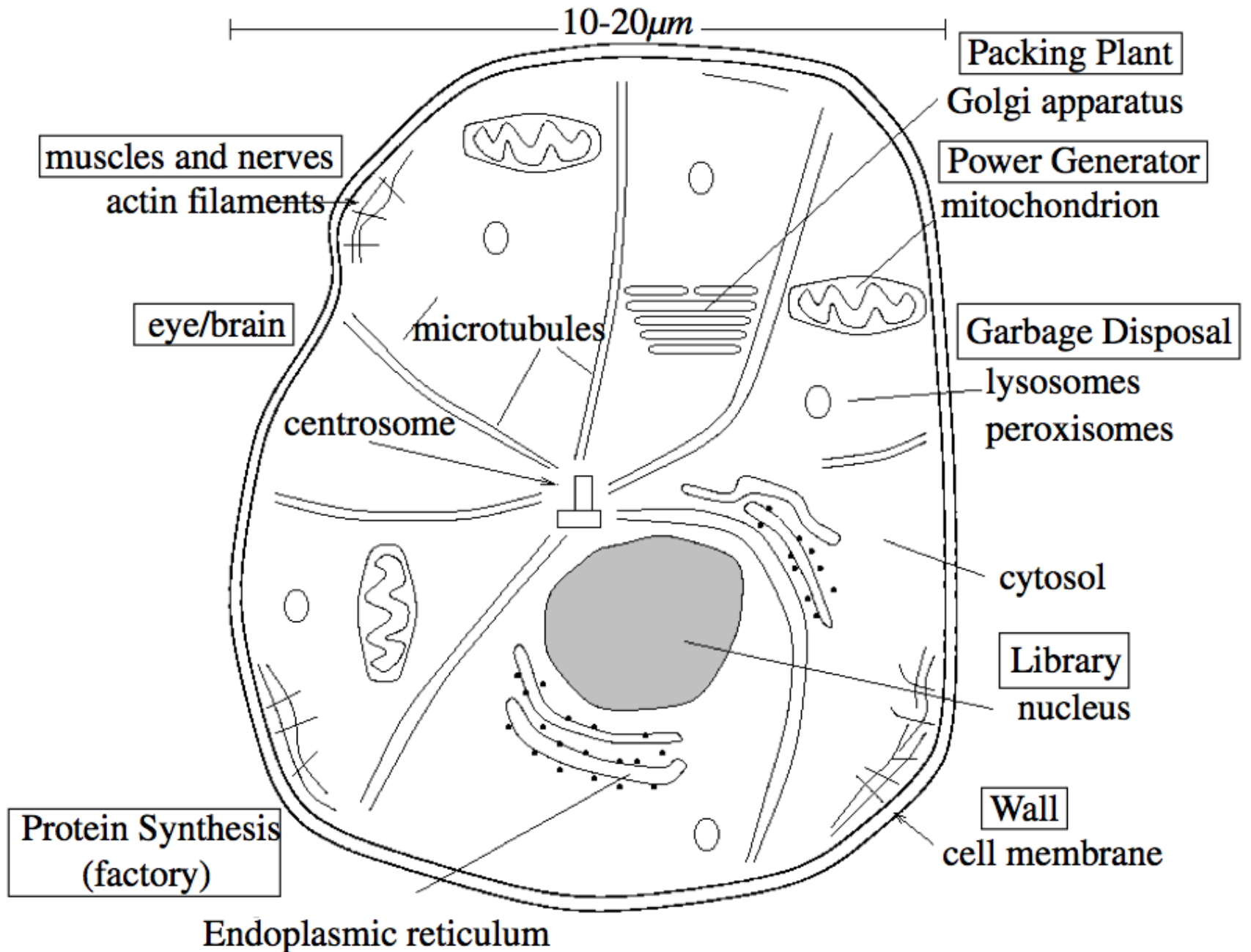

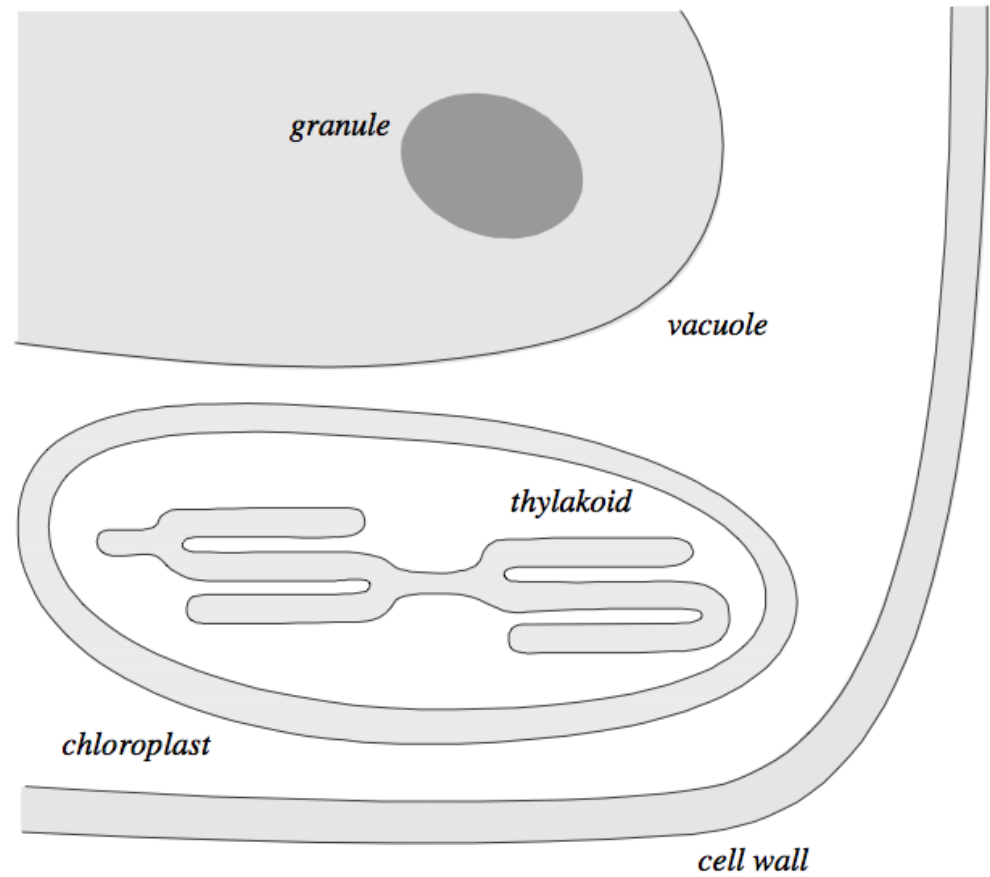
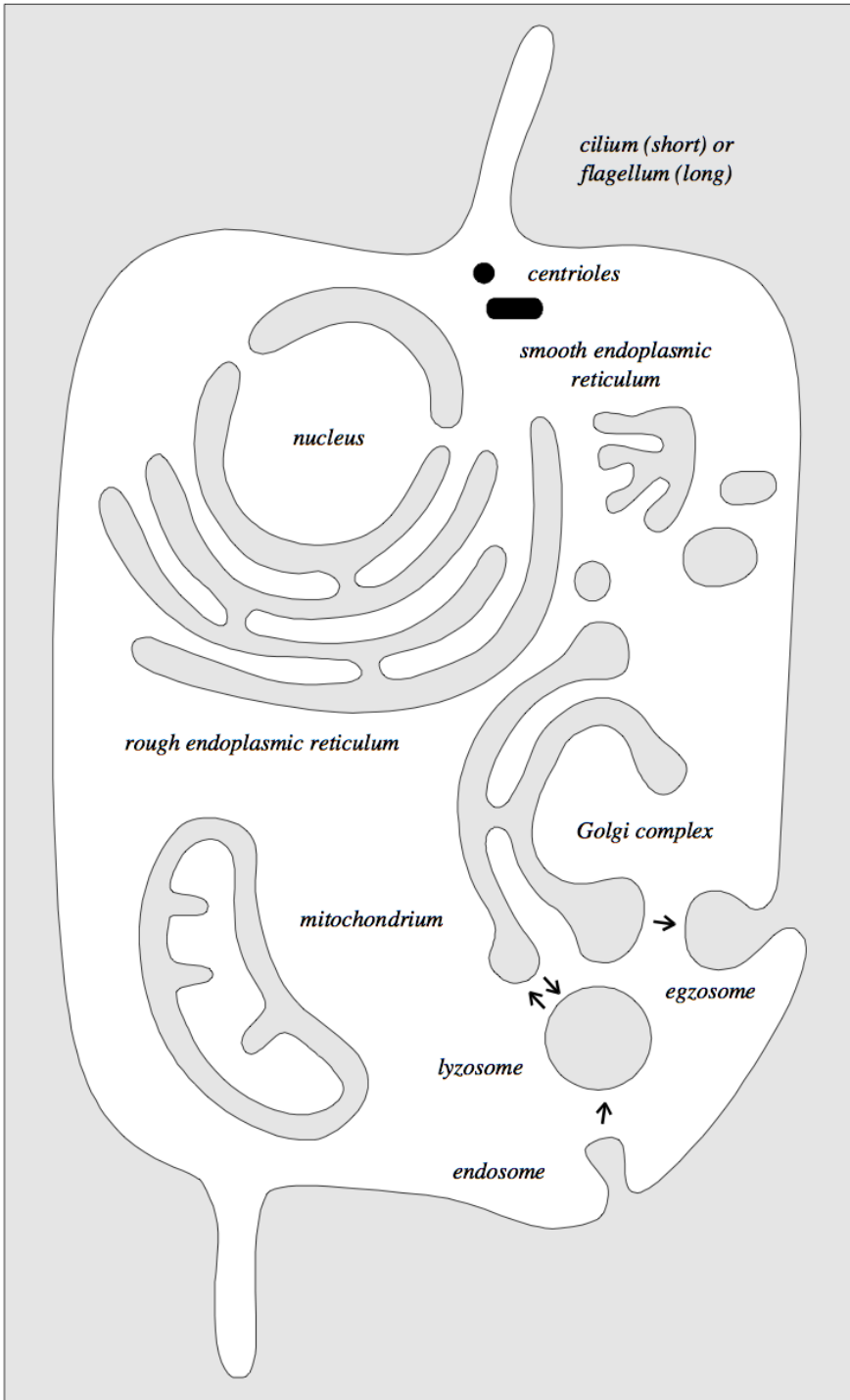

Další organely v rostlinné buňce

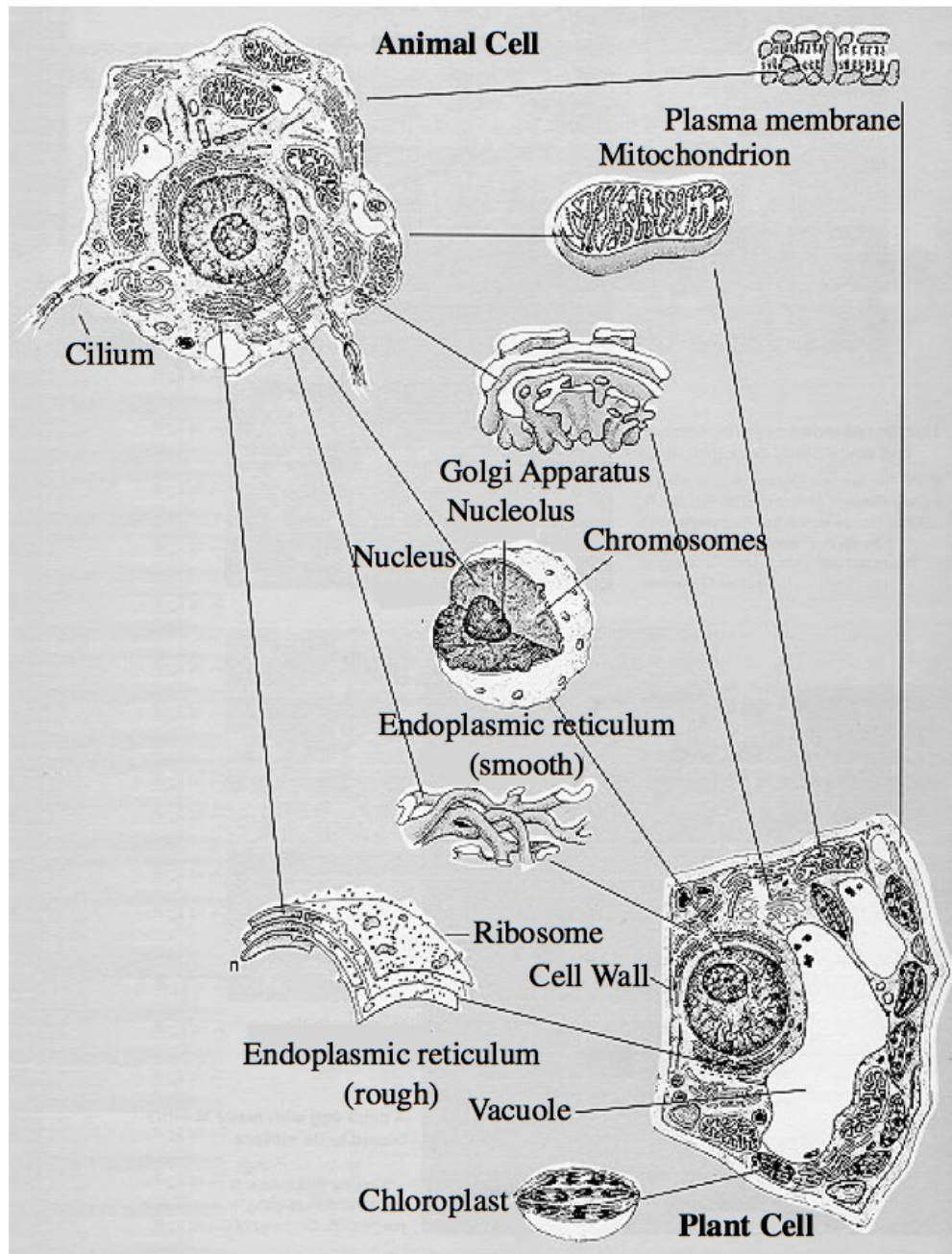

Makromolekulární konsenzus v buňce *E. coli*

Substance	% of total dry weight	Number of molecules
Macromolecule		
Protein	55.0	2.4×10^6
RNA	20.4	
23S RNA	10.6	19,000
16S RNA	5.5	19,000
5S RNA	0.4	19,000
Transfer RNA (4S)	2.9	200,000
Messenger RNA	0.8	1,400
Phospholipid	9.1	22×10^6
Lipopolysaccharide	3.4	1.2×10^6
DNA	3.1	2
Murein	2.5	1
Glycogen	2.5	4,360
Total macromolecules	96.1	
Small molecules		
Metabolites, building blocks, etc.	2.9	
Inorganic ions	1.0	
Total small molecules	3.9	

<i>E. coli</i>	Cell volume	$V_{E. coli}$	$\approx 1 \mu\text{m}^3$
	Cell mass	$m_{E. coli}$	$\approx 1 \text{ pg}$
	Cell cycle time	$t_{E. coli}$	$\approx 3000 \text{ s}$
	Cell surface area	$A_{E. coli}$	$\approx 6 \mu\text{m}^2$
	Genome length	$N_{bp}^{E. coli}$	$\approx 5 \times 10^6 \text{ bp}$
	Swimming speed	$v_{E. coli}$	$\approx 20 \mu\text{m/s}$
Yeast	Volume of cell	V_{yeast}	$\approx 60 \mu\text{m}^3$
	Mass of cell	m_{yeast}	$\approx 60 \text{ pg}$
	Diameter of cell	d_{yeast}	$\approx 5 \mu\text{m}$
	Cell cycle time	t_{yeast}	$\approx 200 \text{ min}$
	Genome length	N_{bp}^{yeast}	$\approx 10^7 \text{ bp}$
Organelles	Diameter of nucleus	$d_{nucleus}$	$\approx 5 \mu\text{m}$
	Length of mitochondrion	l_{mito}	$\approx 2 \mu\text{m}$
	Diameter of transport vesicles	$d_{vesicle}$	$\approx 50 \text{ nm}$
Water	Volume of molecule	V_{H_2O}	$\approx 10^{-2} \text{ nm}^3$
	Density of water	ρ	1 g/cm^3
	Viscosity of water	η	$\approx 1 \text{ centipoise}$ $(10^{-2} \text{ g/(cm s)})$
	Hydrophobic embedding energy	$\approx E_{hydr}$	$25 \text{ cal/(mol } \text{Å}^2)$
DNA	Length per base pair	l_{bp}	$\approx 1/3 \text{ nm}$
	Volume per base pair	V_{bp}	$\approx 1 \text{ nm}^3$
	Charge density	λ_{DNA}	$2 \text{ e}/0.34 \text{ nm}$
	Persistence length	ξ_p	50 nm
Amino acids and proteins	Radius of "average" protein	$r_{protein}$	$\approx 2 \text{ nm}$
	Volume of "average" protein	$V_{protein}$	$\approx 25 \text{ nm}^3$
	Mass of "average" amino acid	M_{aa}	$\approx 100 \text{ Da}$
	Mass of "average" protein	$M_{protein}$	$\approx 30,000 \text{ Da}$
	Protein concentration in cytoplasm	$c_{protein}$	$\approx 300 \text{ mg/mL}$
	Characteristic force of protein motor	F_{motor}	$\approx 5 \text{ pN}$
	Characteristic speed of protein motor	v_{motor}	$\approx 200 \text{ nm/s}$
	Diffusion constant of "average" protein	$D_{protein}$	$\approx 100 \mu\text{m}^2/\text{s}$
Lipid bilayers	Thickness of lipid bilayer	d	$\approx 5 \text{ nm}$
	Area per molecule	A_{lipid}	$\approx \frac{1}{2} \text{ nm}^2$
	Mass of lipid molecule	m_{lipid}	$\approx 800 \text{ Da}$

(A) development of *Drosophila*

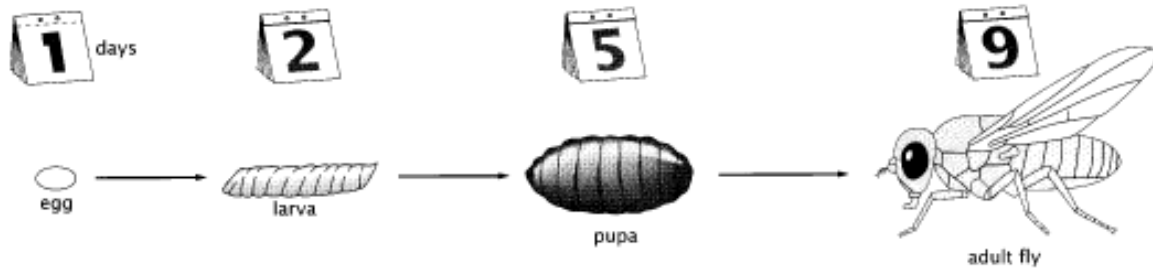

(B) early development of *Drosophila* embryo

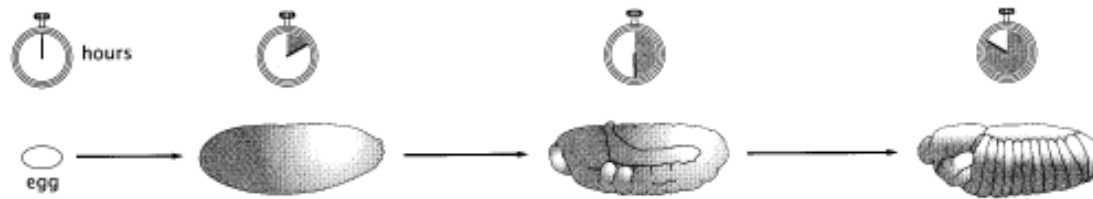

(C) bacterial cell division

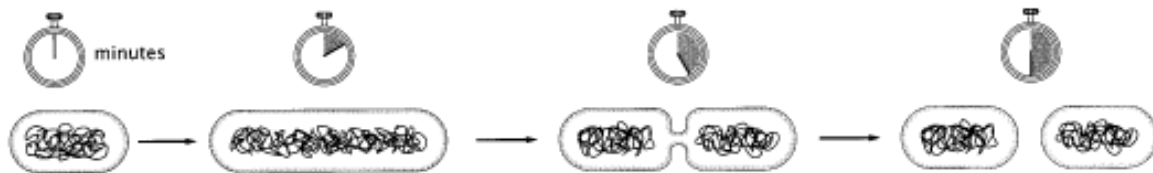

(D) cell movements



(E) protein synthesis

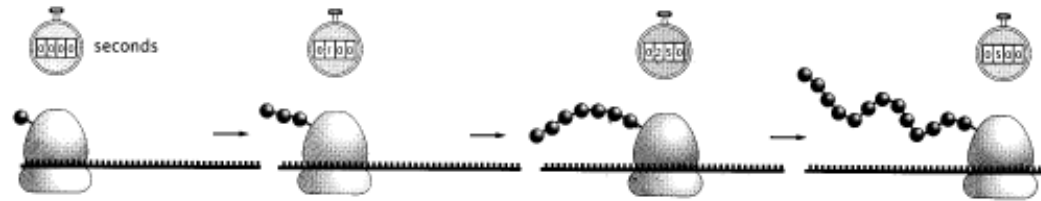

(F) transcription

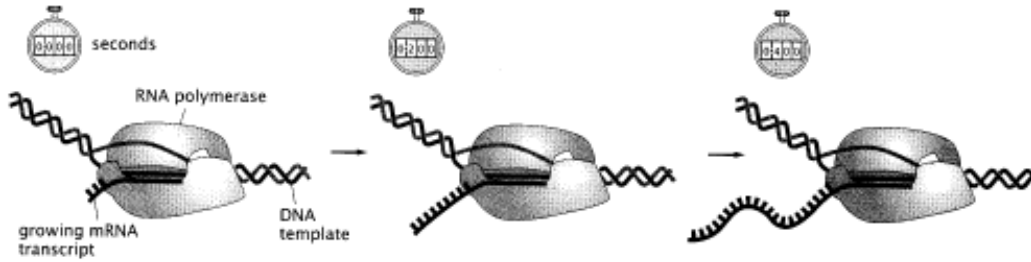

(G) gating of ion channels

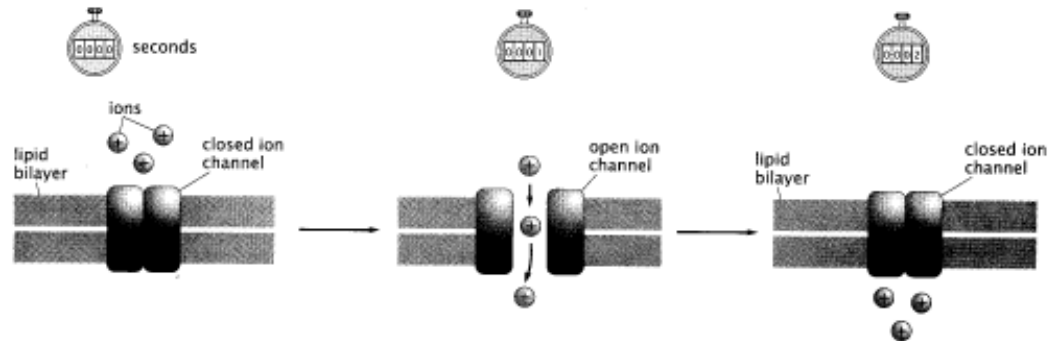

(H) enzyme catalysis

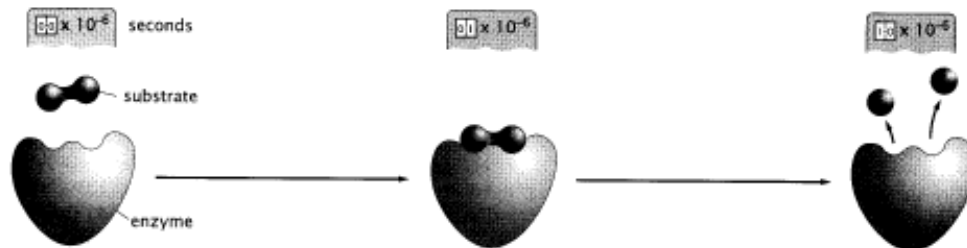

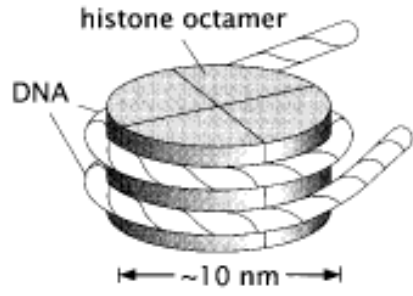

(A) nucleosome

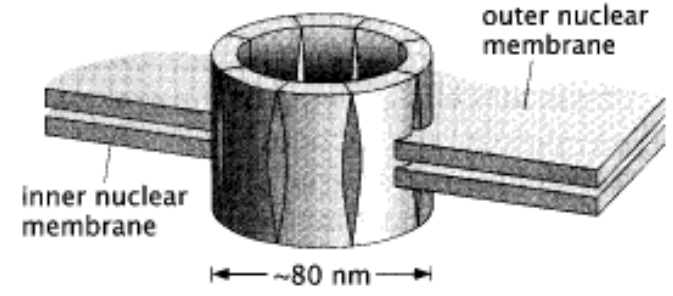

(B) nuclear pore complex

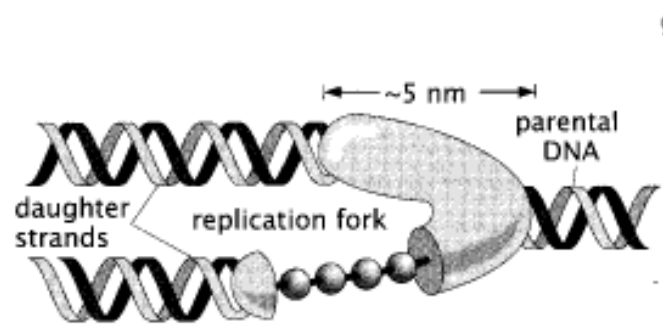

(C) replisome

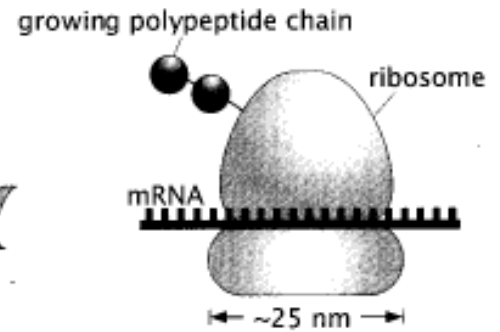

(D) ribosome

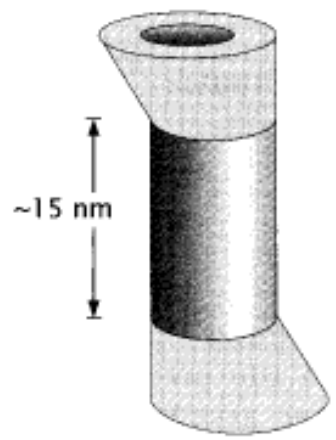

(E) proteasome

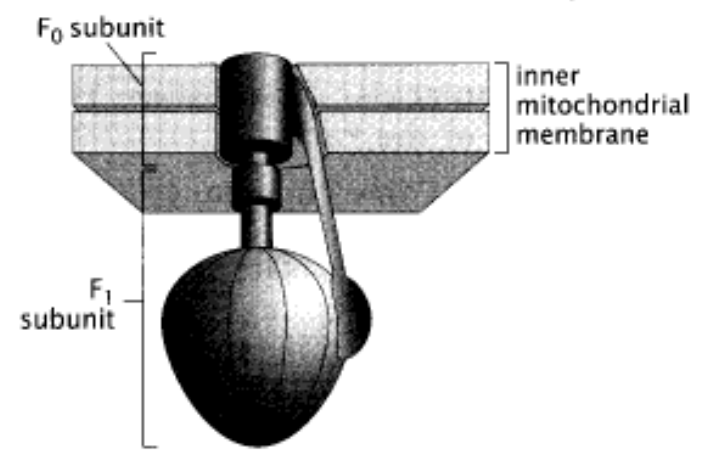

(F) ATP synthase

bioRxiv

THE PREPRINT SERVER FOR BIOLOGY

Advanced Search

COVID-19 SARS-CoV-2 preprints from medRxiv and bioRxiv

Subject Areas

All Articles

Animal Behavior and Cognition	Ecology	Paleontology
Biochemistry	Epidemiology*	Pathology
Bioengineering	Evolutionary Biology	Pharmacology and Toxicology
Bioinformatics	Genetics	Physiology
Biophysics	Genomics	Plant Biology
Cancer Biology	Immunology	Scientific Communication and Education
Cell Biology	Microbiology	Synthetic Biology
Clinical Trials*	Molecular Biology	Systems Biology
Developmental Biology	Neuroscience	Zoology

View by Month

* The Clinical Trials and Epidemiology subject categories are now closed to new submissions following the completion of bioRxiv's clinical research pilot project and launch of the dedicated health sciences server medRxiv (submit.medrxiv.org). New papers that report results of Clinical Trials must now be submitted to medRxiv. Most new Epidemiology papers also should be submitted to medRxiv, but if a paper contains no health-related information, authors may choose to submit it to another bioRxiv subject category (e.g., Genetics or Microbiology).

Mosalaganti, Obarska-Kosinska, Siggel et al

Title: Artificial intelligence reveals nuclear pore complexity

Authors:

Shyamal Mosalaganti^{1,2,3†}, Agnieszka Obarska-Kosinska^{1,4†}, Marc Siggel^{4,5,6†}, Beata Turonova^{1,2}, Christian E. Zimmerli^{1,2}, Katarzyna Buczak^{2‡}, Florian H. Schmidt^{2§}, Erica Margiotta^{1,2}, Marie-Therese Mackmull^{2¶}, Wim Hagen², Gerhard Hummer^{5,7*}, Martin Beck^{1,2*}, Jan Kosinski^{2,4,6*}

THE BEST INVENTIONS OF 2022

200 innovations changing how we live

How We Chose the List

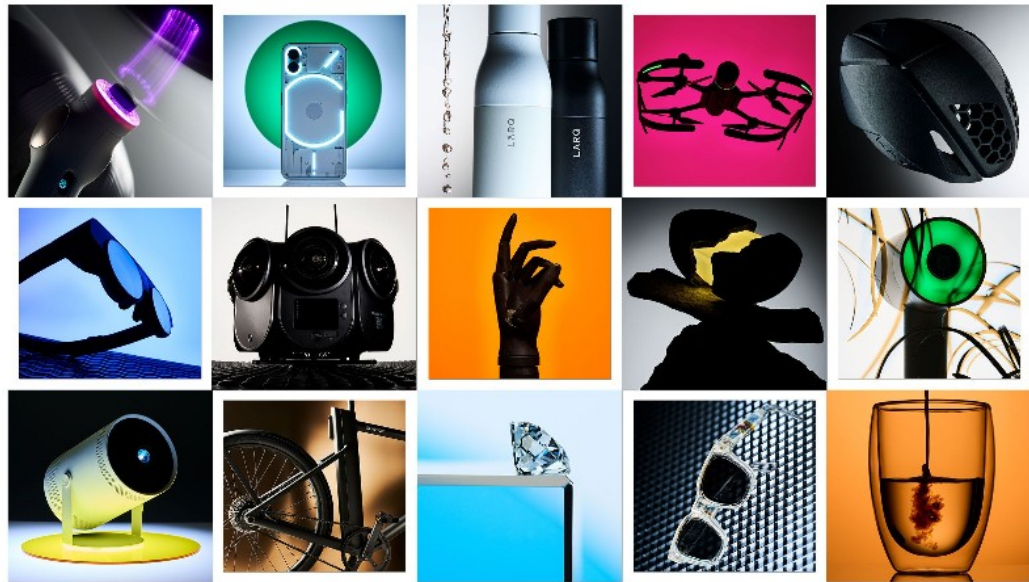

Sergiy Barchuk for TIME

TIME
S I T E S

The Best Inventions of 2022 homepage is built on TIME Sites. To learn how businesses use TIME Sites to tell their stories with easy-to-deploy, visually stunning microsites, visit timesites.com.

<https://time.com/collection/best-inventions-2022/6229912/deepmind-alphafold/>

AI

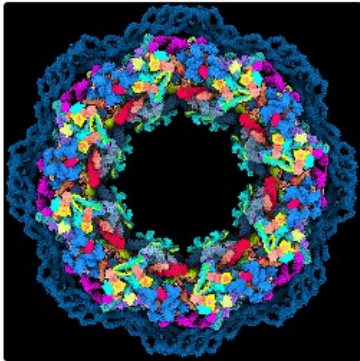

MAPPING LIFE'S BUILDING BLOCKS
DEEPMIND ALPHAFOLD



DETECTING DESTRUCTION OF WAR
SCALE AI AUTOMATED DAMAGE IDENTIFICATION



ARTIFICIAL IMAGINATION
OPENAI DALL-E 2



Mapping Life

DeepMind AlphaFold

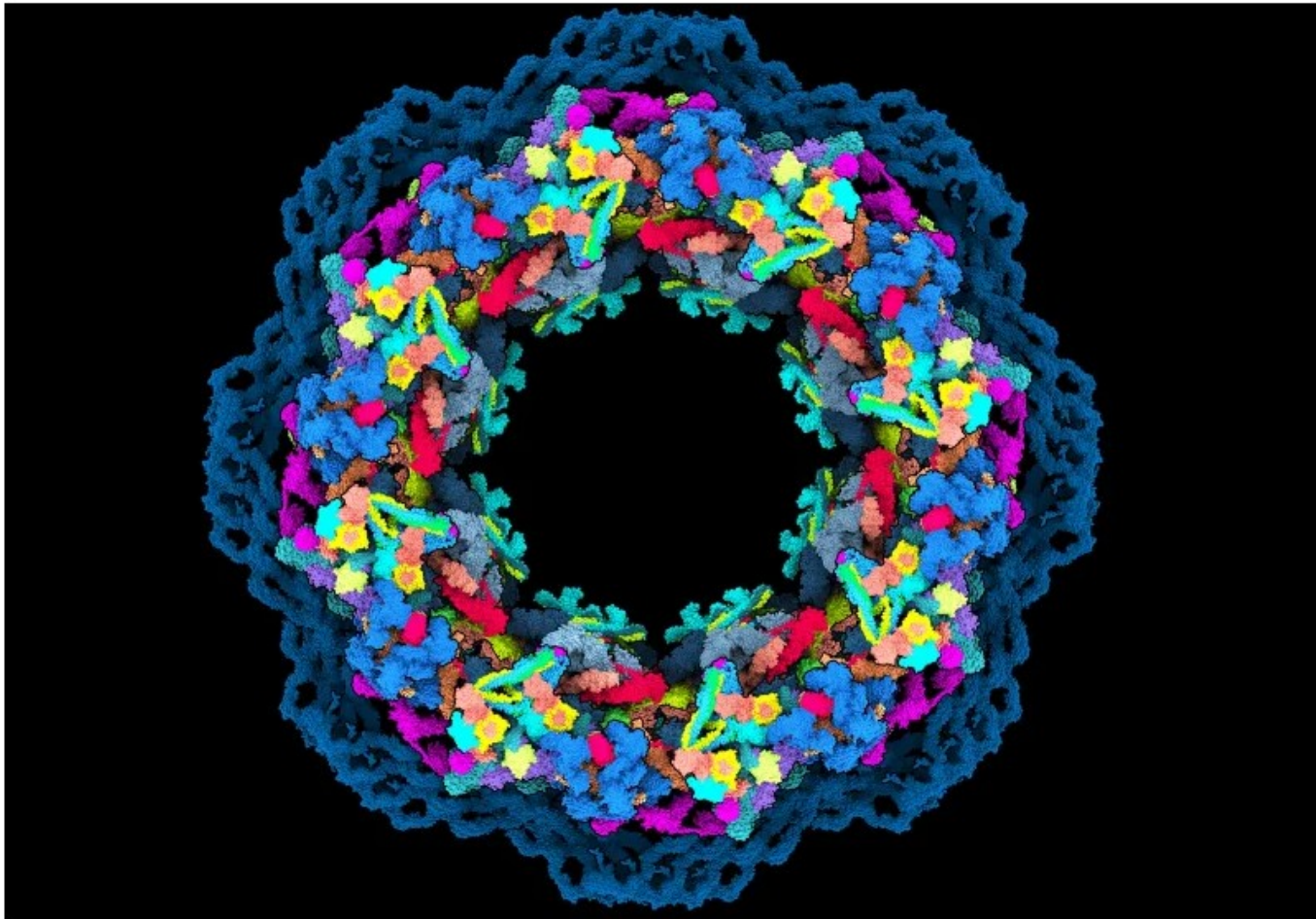

In the recent past, discerning the exact 3D structure of a single protein took around five years. Today the same task is possible in seconds thanks to the machine learning program **AlphaFold**, developed by Alphabet subsidiary DeepMind. In July, the company announced that AlphaFold had predicted the structures of 200 million proteins—nearly all known to humankind. And in what CEO Demis Hassabis described as a “**gift to humanity**,” DeepMind made the structures, along with AlphaFold’s underlying code, freely available to all. That will likely accelerate the work of scientists around the world trying to solve humanity’s toughest problems. The company says AlphaFold is now being used in efforts as diverse as fighting antibiotic resistance and Parkinson’s disease, and tackling plastic pollution.

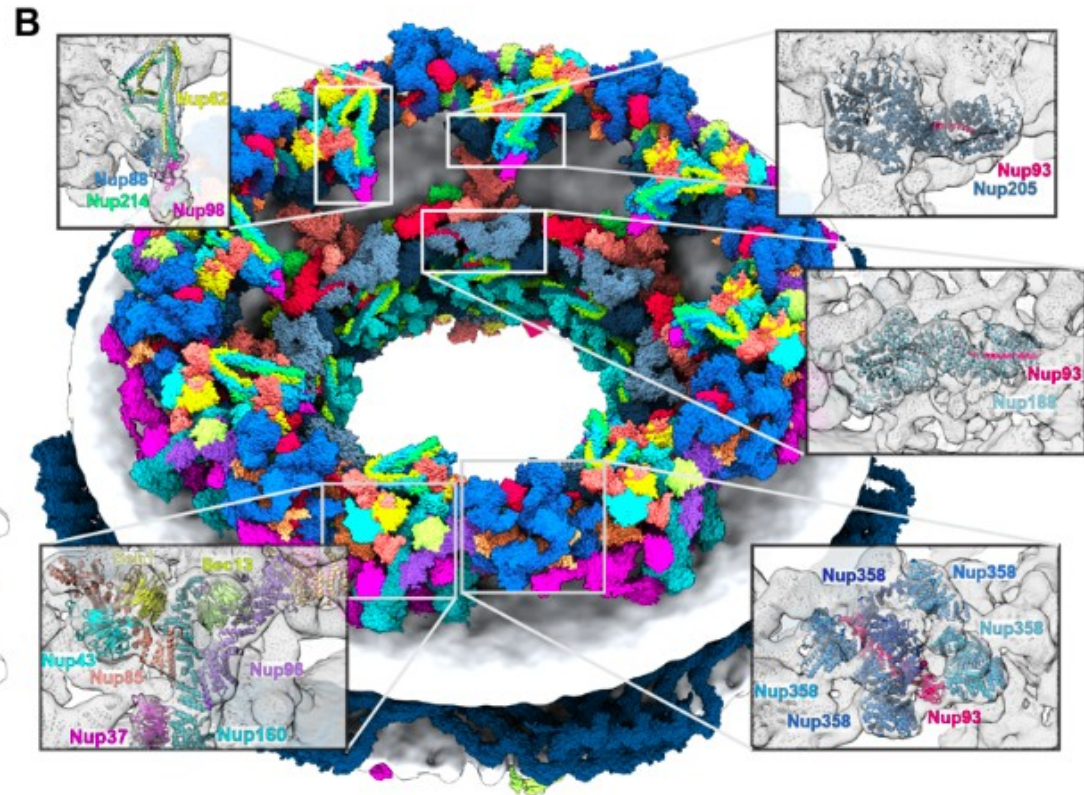
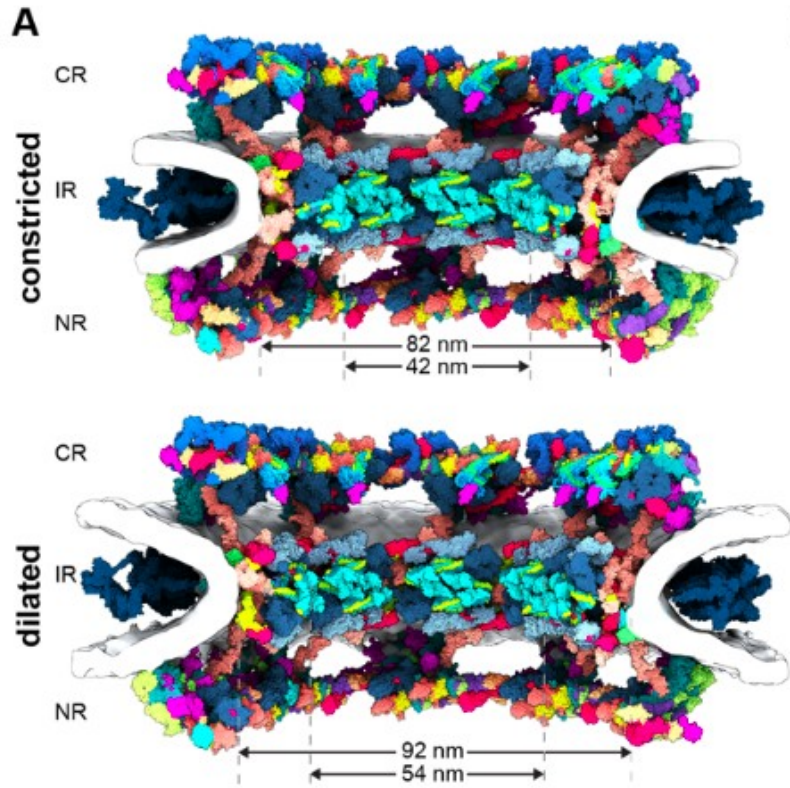

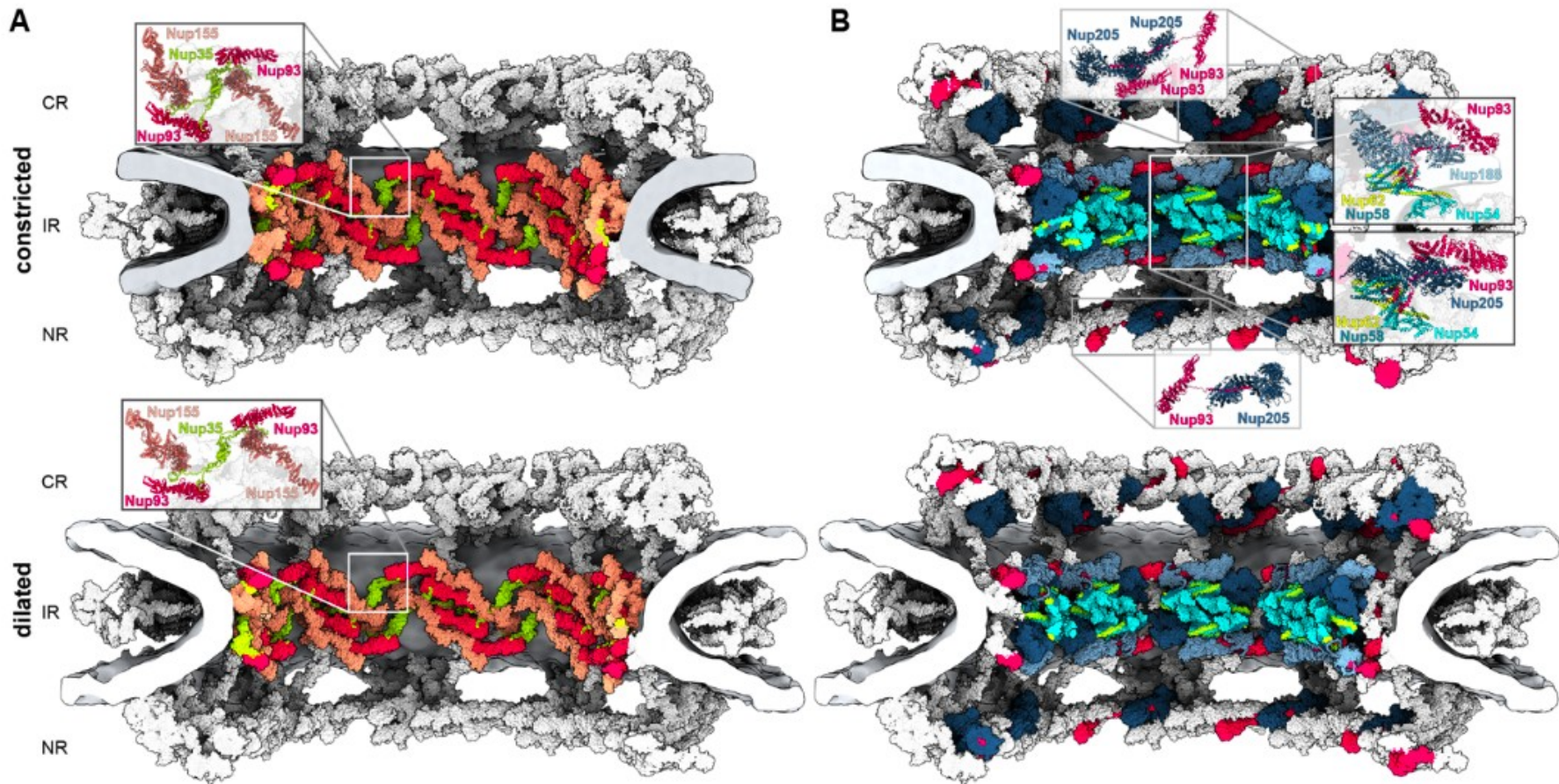

constricted

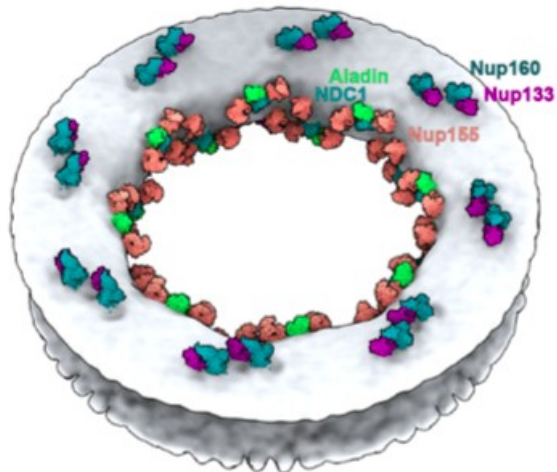

dilated

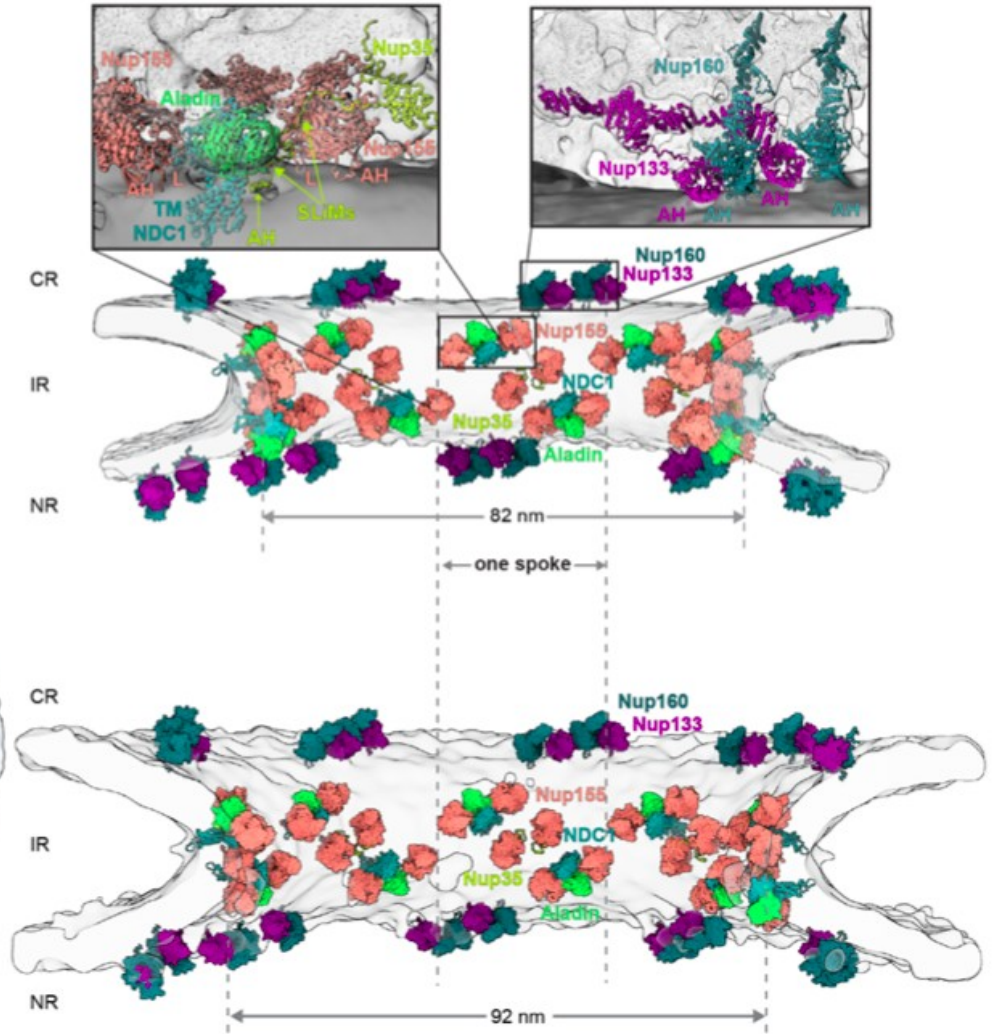
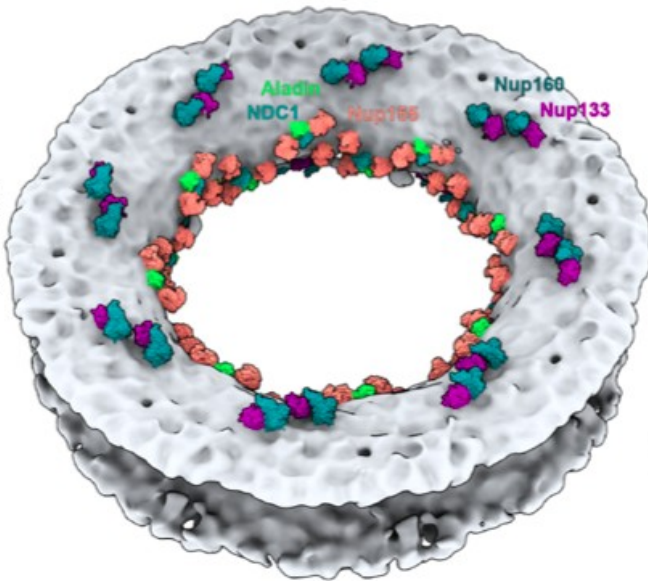

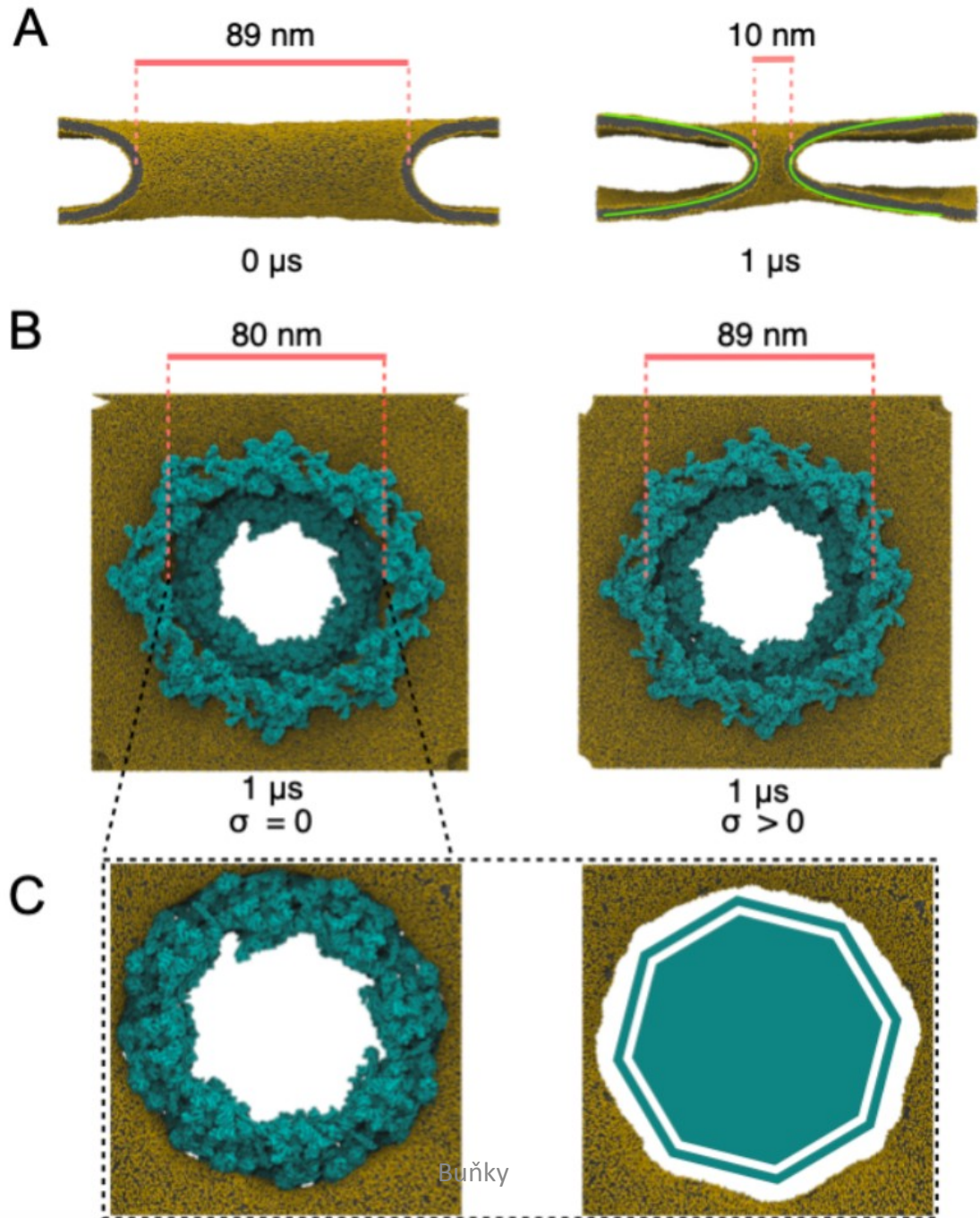

Karolin Luger:

How it all began – Genome organization in humans, ancient bacteria, and giant viruses

<https://www.youtube.com/watch?v=RSB9Lm3LscU>

Od cca 18. minuty

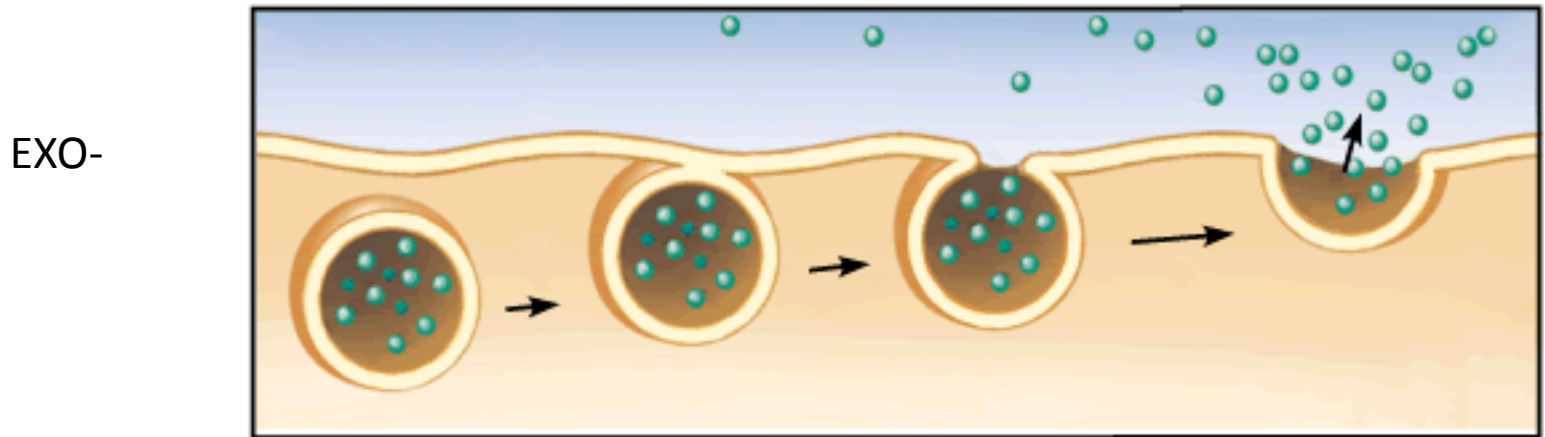
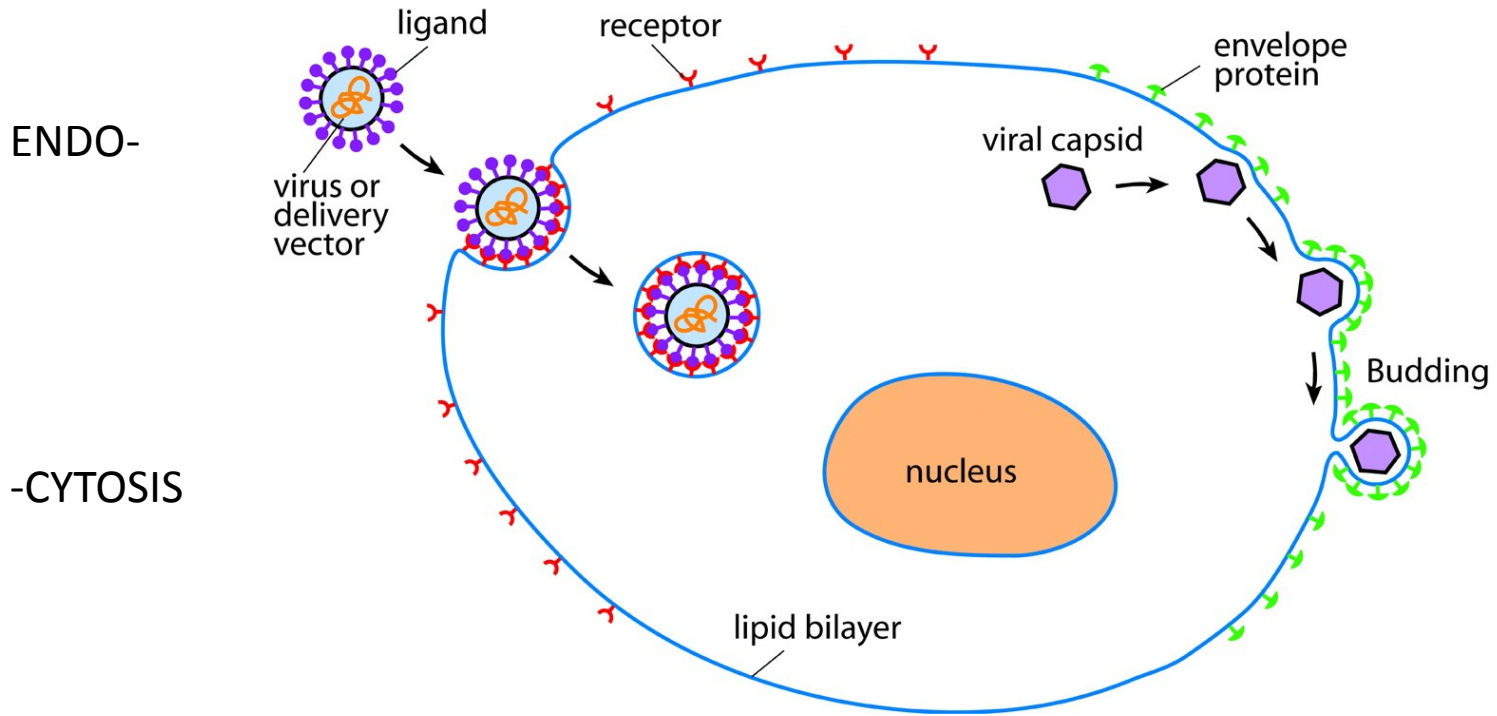

Mitochondrie

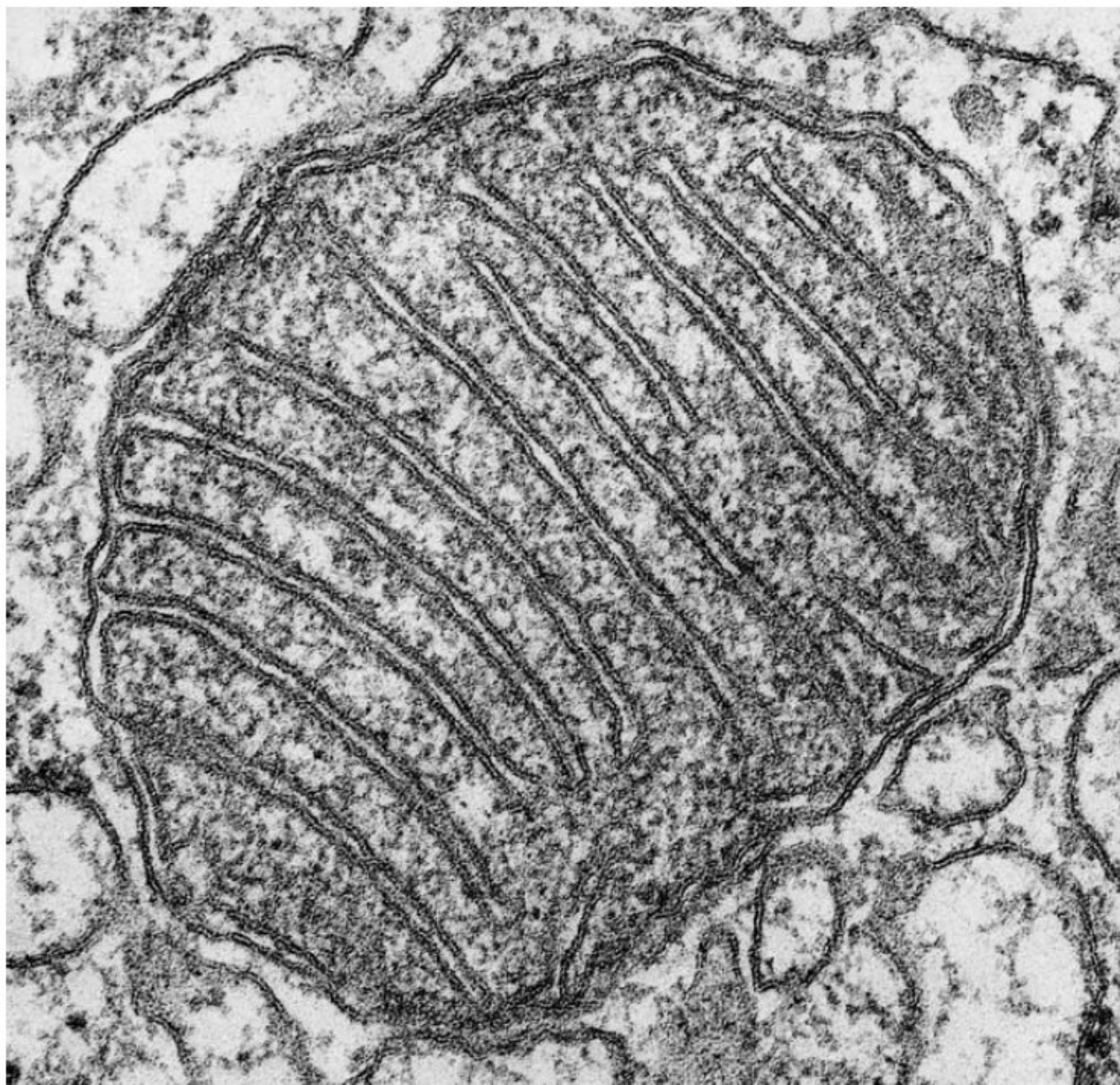

(A) 2022/11/15

Buňky

100 nm

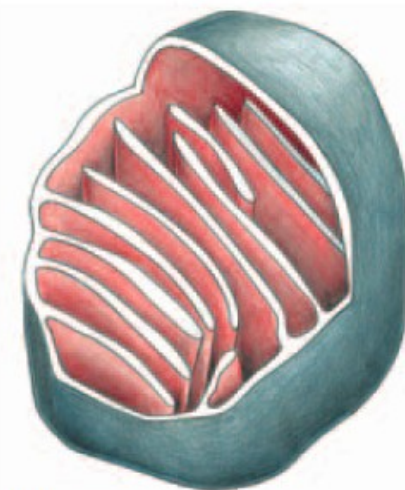

(B)

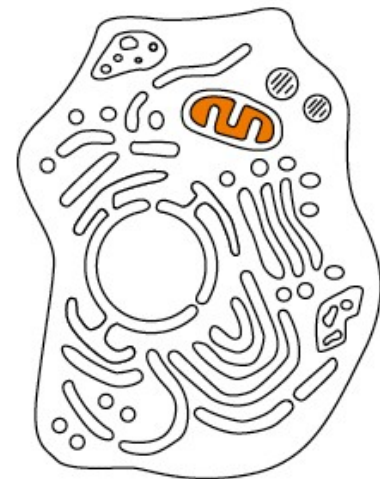

(C)

28

Fission – dělení mitochondrie

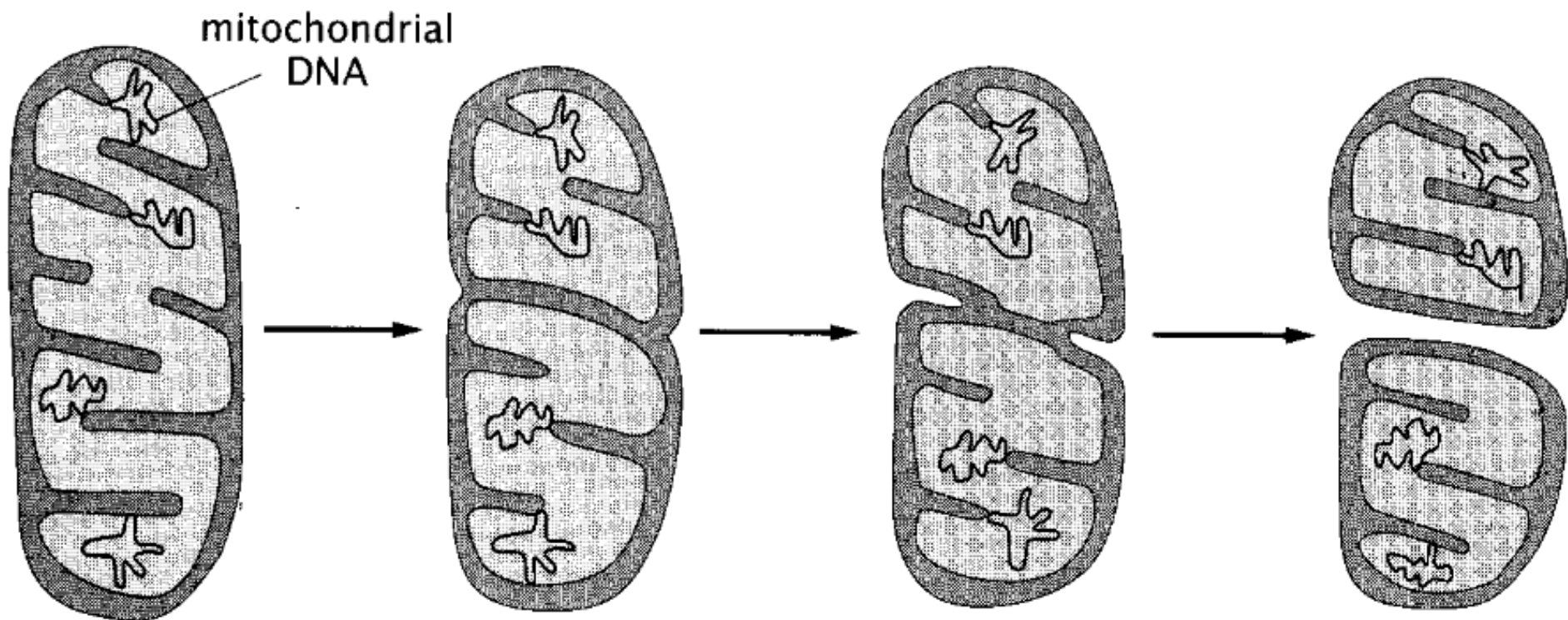

Vznik mitochondrie

