

Turbulent convection

Michal Macek
michal.macek@isibrno.cz

Group of Cryogenics and Superconductivity

The Czech Academy of Sciences Institute of Scientific
Instruments

research departments



New Technologies

Ing. Martin Zobač, Ph.D.



Medical Signals

Ing. Pavel Jurák, CSc.



Microphotonics

prof. RNDr. Pavel Zemánek, Ph.D.



Magnetic Resonance and Cryogenics

Ing. Zenon Starčuk, CSc.



Electron Microscopy

Mgr. Tomáš Radlička, Ph.D.



Coherent Optics

prof. Ing. Josef Lazar, Dr.

In 1967



In 2023





Letní stáže na ÚPT AV

Petr TOMÁŠEK
12. 5. 2022



Nabídka letních stáží na Ústavu přístrojové techniky Akademie věd České republiky

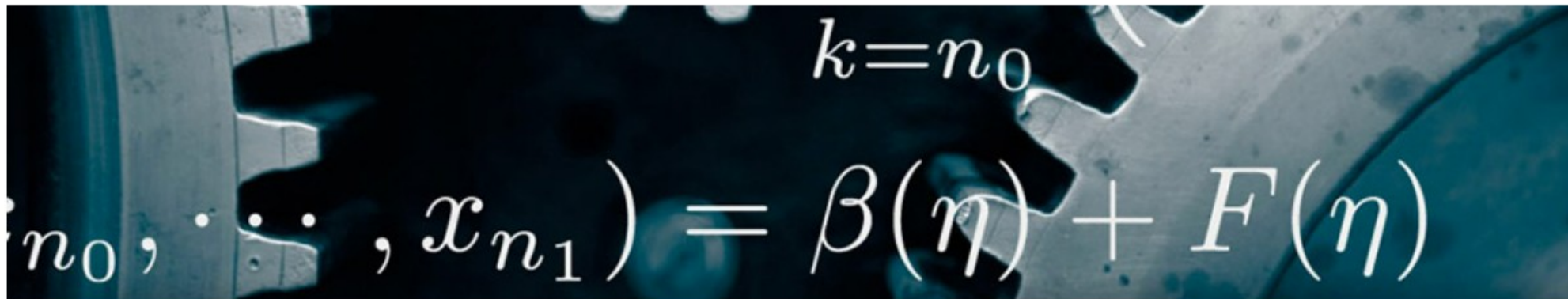

Ústav přístrojové techniky Akademie věd České republiky nabízí studentům placené stáže v průběhu letních prázdnin. Více informací [zde](#):

<https://www.isibrno.cz/cs/letni-staze-na-upt-v-roce-2022>

Získané zkušenosti a kontakty lze využít i pro formulaci a zpracování tématu závěrečné bakalářské či

Cryogenics at ISI CAS Brno

Dny otevřených dveří

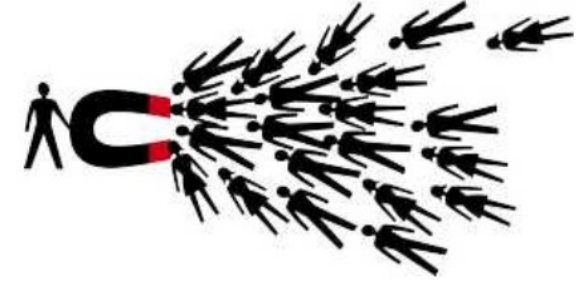

© Tomas Danek

© Tomas Danek

Heat Transport at Low Temperatures (~5K)

Heat transport by Radiation

Emister apparatus
(far-field regime)



EWA apparatus
(near-field regime)

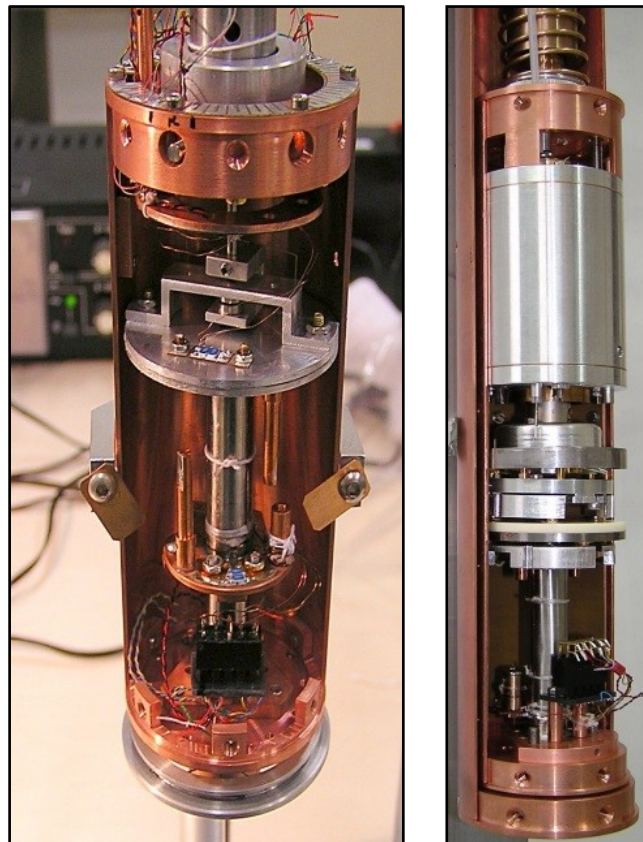

Heat transport by Convection

ConEV apparatus
(Rayleigh-Bénard convection)



PRL **109**, 224302 (2012), PRB **99**, 024511 (2019)

... discussed in detail today

Outline of Lecture

1. Basic aspects

[1 a] Heat Transport

[1 b] Turbulent Flows

[1 c] Helium ^4He

2. Experiments in Brno: Classical turbulent Rayleigh-Benard convection

[2 a] $\text{Nu}(\text{Ra})$ - Heat transport efficiency

[2 b] $\text{Re}(\text{Ra})$ - Dynamics of coherent structures (wind)

3. New research directions

[3 a] Attractors in RBC

[3 b] Modulated Convection and Rotation

[3 c] Visualization of ^4He flows – metastable molecular excimers

[3 d] Classical and Quantum heat transfers - analogies

Basic Heat transport mechanisms: Recall...

- 1. ?

- 2. ??

- 3. ???

Basic Heat transport mechanisms: Recall...

- 1. Radiation (everywhere, including vacuum):

$$\text{Stefan-Boltzmann's law: } \vec{q} = \sigma \varepsilon T^4 \vec{n}$$

σ black-body constant
 ε surface emissivity

- 2. Conduction (all matter: solid bodies or motionless fluids):

$$\text{Fourier's law: } \vec{q} = -\lambda \vec{\nabla} T$$

λ microscopic conductivity

– depends on structure of the material
(molecular/crystal lattice,...)

- 3. Convection (in flowing matter):

$$\text{"Fourier-like law": } \vec{q} = -\lambda^* \vec{\nabla} T$$

λ^* effective conductivity

– depends on the nature of the flow field
(laminar/turbulent)

Turbulence

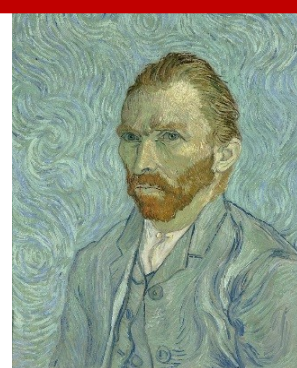
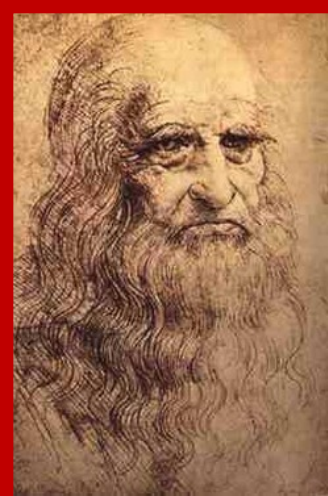

Leonardo da Vinci (1452-1519)

'View of Water Vortex,'
cca. 1510 - 1513.
Royal Collection Windsor, UK

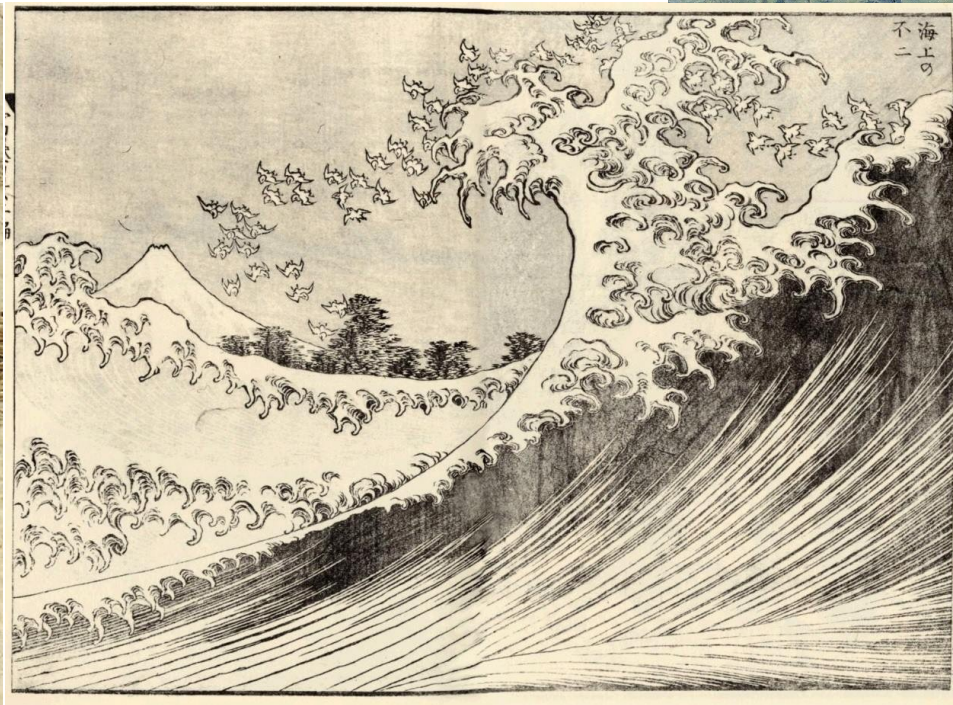

'Mount Fuji viewed from the sea,'
from One Hundred Views of Mount Fuji, ca.
1834.
British Museum

Katsushika Hokusai
(1760-1849)



Vincent van Gogh (1853-1890)
'Starry Night'
1889.
MoMA, New York

Turbulence: Scales And Cascades

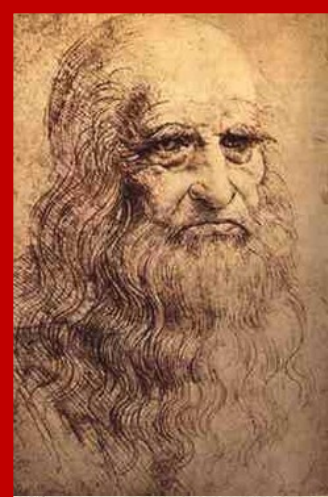

Leonardo da Vinci (1452-1519)
 Drawing of Water Vortex,
 cca. 1510 - 1513.
 Royal Collection Windsor, UK



“Big whirls have little whirls,
 That feed on their velocity,
 And little whirls have lesser
 whirls,
 And so on to viscosity.”

Lewis Fry

Richardson

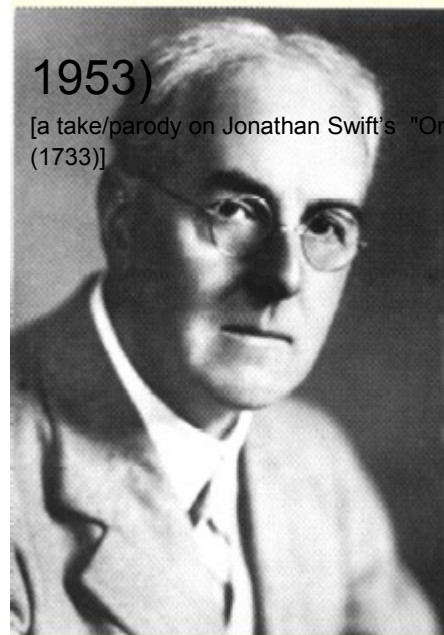

1953)

[a take/parody on Jonathan Swift's "On Poetry: a Rhapsody" (1733)]

Richardson cascade

- Starting at forcing scale
- Ending at viscous dissipation scale

(1881 - l_0)

time

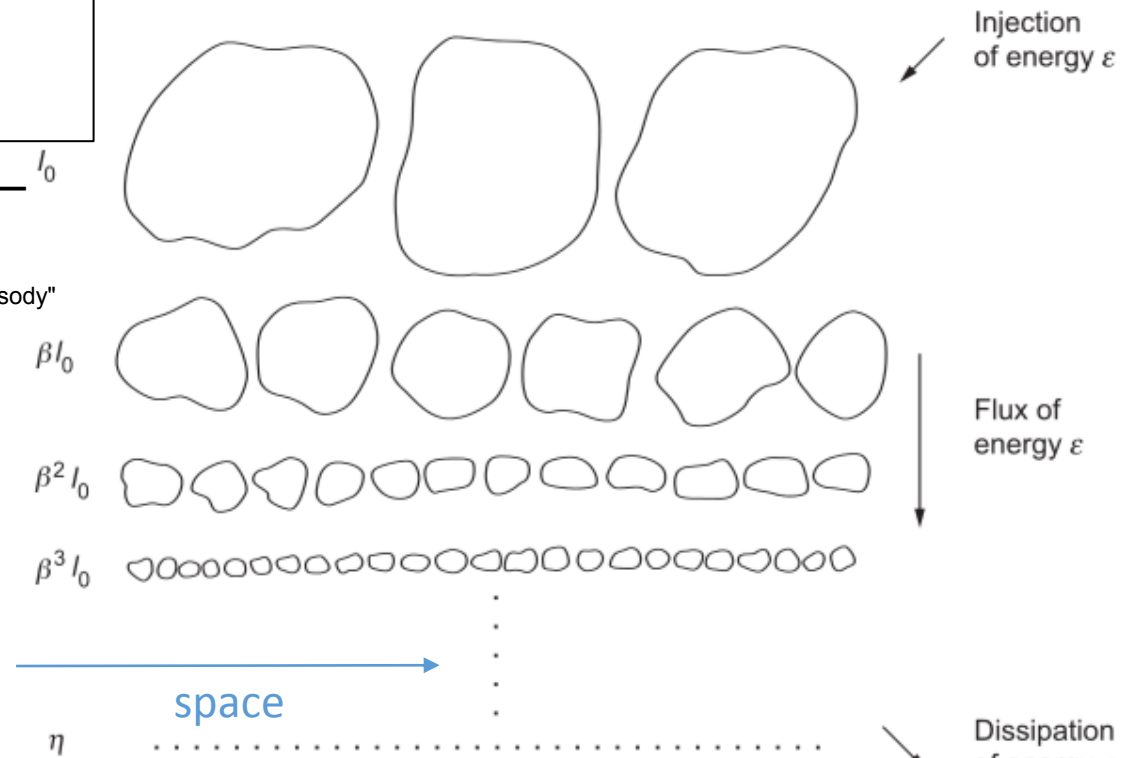

Adapted from: Uriel Frisch. 1995. Turbulence: The Legacy of A. N. Kolmogorov.

Turbulence: Scales And Cascades

“Big whirls have little whirls,
That feed on their velocity,
And little whirls have lesser
whirls,
And so on to viscosity.”

Lewis Fry

Richardson

(1881 –

1953)

[a take/parody on Jonathan Swift's "On Pigs" (1733)]

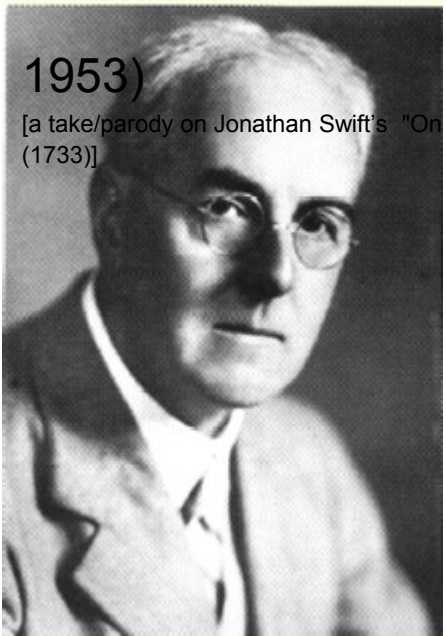

Richardson – Kolmogorov cascade

- Starting at forcing scale
- Ending at viscous dissipation scale
- Broad and smooth kinetic energy spectrum

Andrey
Nikolaevich
Kolmogorov
(1903-1987)

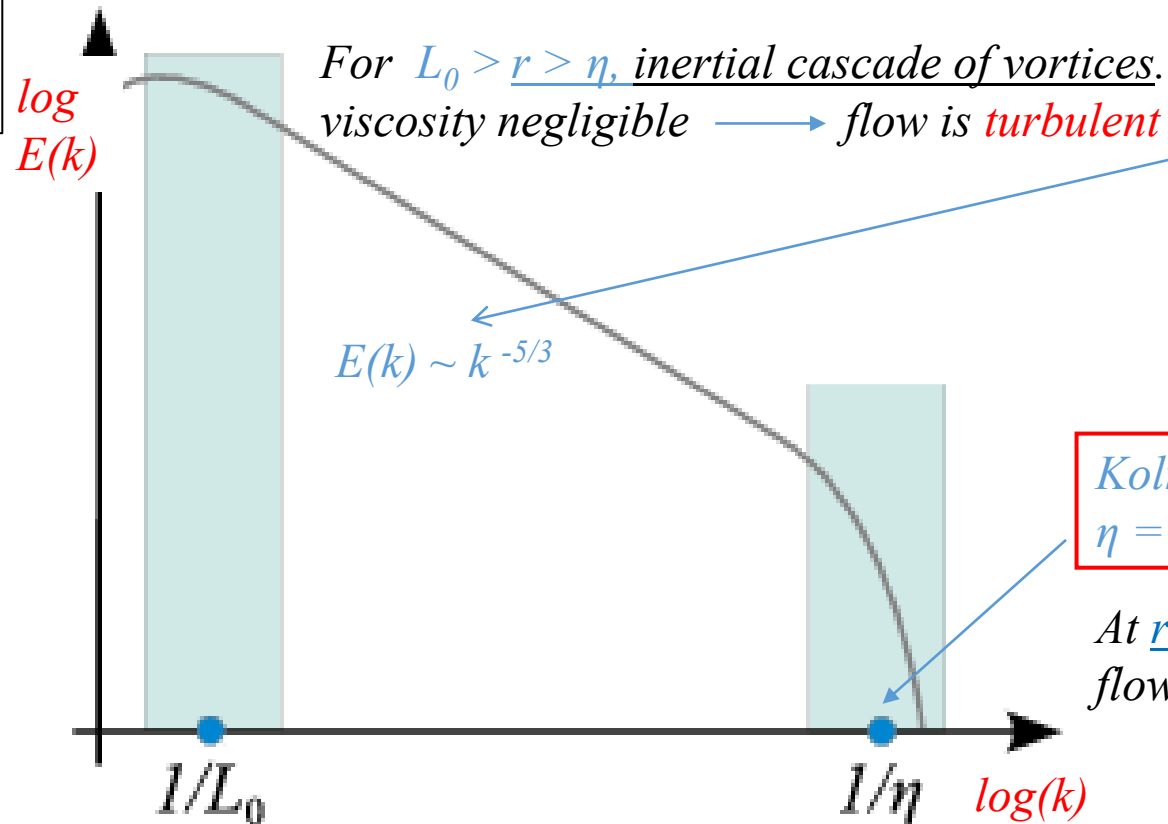
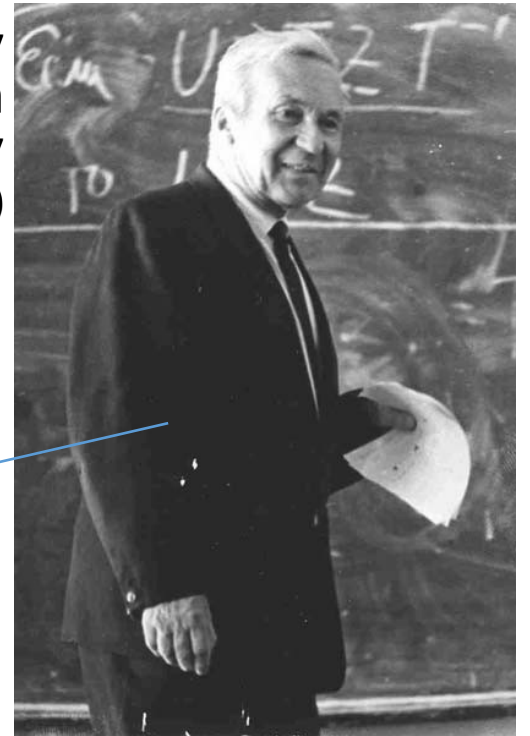

Characteristic scales of turbulence in Nature



M100 galaxy
as seen through Hubble telescope

Maelstrom, Saltstraumen, Norway

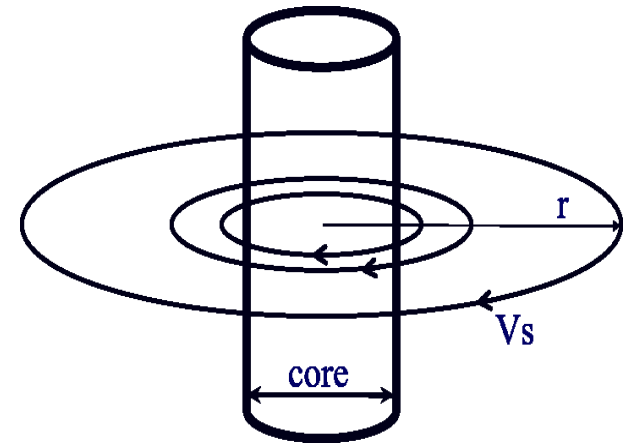

Quantum vortex in superfluid He II

Turbulence: Major open scientific problem

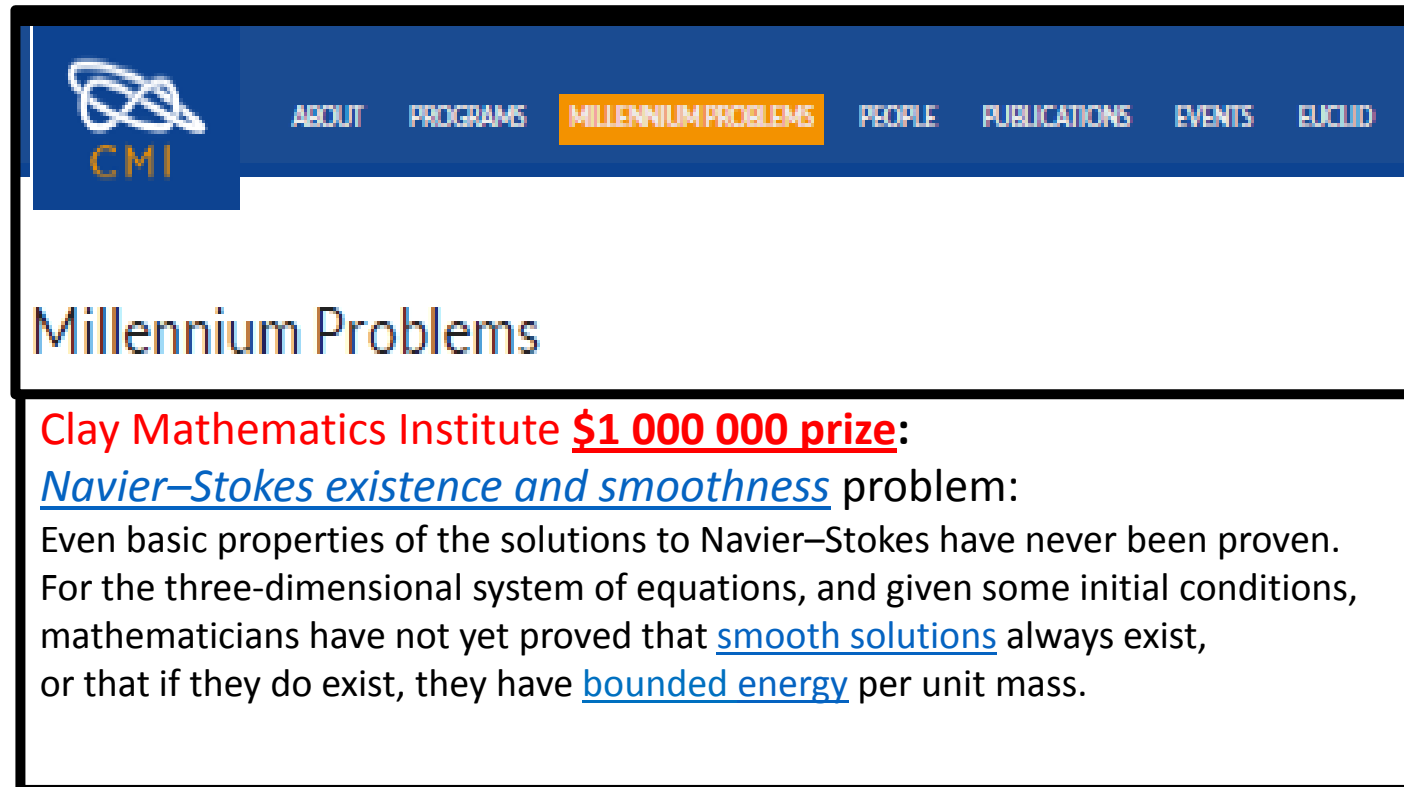

The screenshot shows the Clay Mathematics Institute website. The top navigation bar includes links for ABOUT, PROGRAMS, MILLENNIUM PROBLEMS (highlighted), PEOPLE, PUBLICATIONS, EVENTS, and EUCLID. The main heading is "Millennium Problems". Below this, the text reads: "Clay Mathematics Institute **\$1 000 000 prize:** Navier–Stokes existence and smoothness problem: Even basic properties of the solutions to Navier–Stokes have never been proven. For the three-dimensional system of equations, and given some initial conditions, mathematicians have not yet proved that smooth solutions always exist, or that if they do exist, they have bounded energy per unit mass.



Clear Ideas
by Rene Magritte,
1958



Turbulence onset and Reynolds number

Osborne Reynolds
(1842-1912)

$$Re = \frac{U \cdot L}{\nu}$$

Dimensionless “flow-similarity” number

Reynolds Experiment (1883)

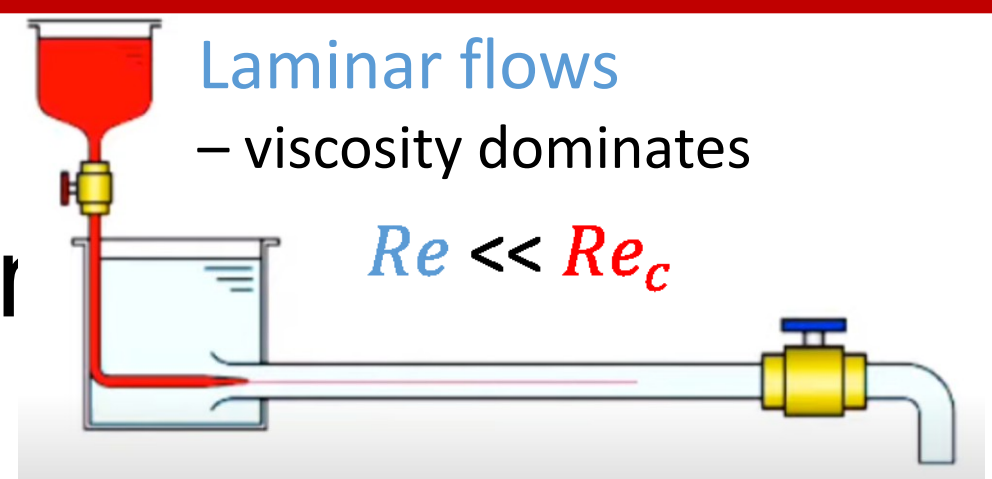
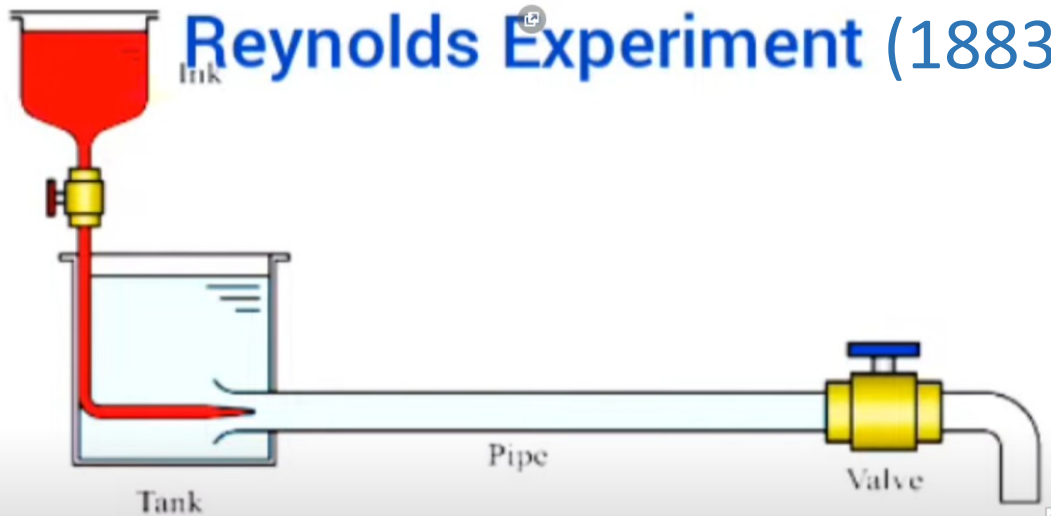

Laminar flows
– viscosity dominates

$$Re \ll Re_c$$

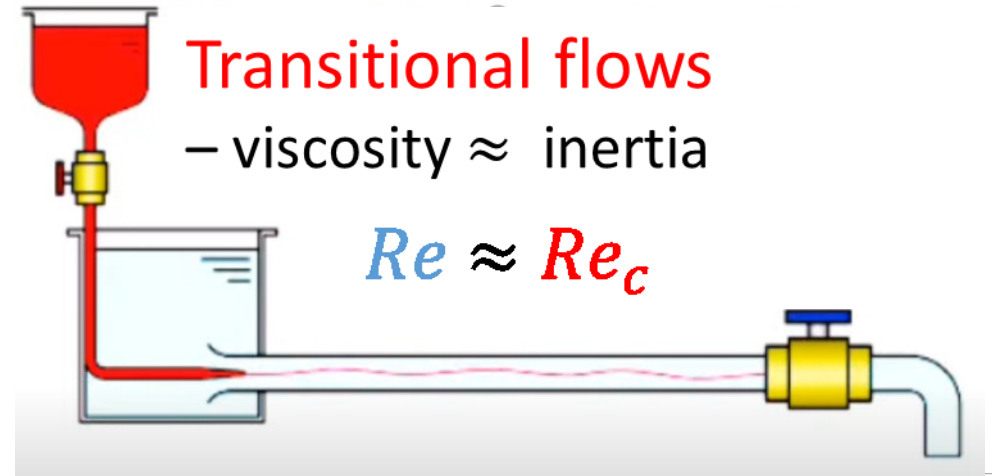

Transitional flows
– viscosity \approx inertia

$$Re \approx Re_c$$

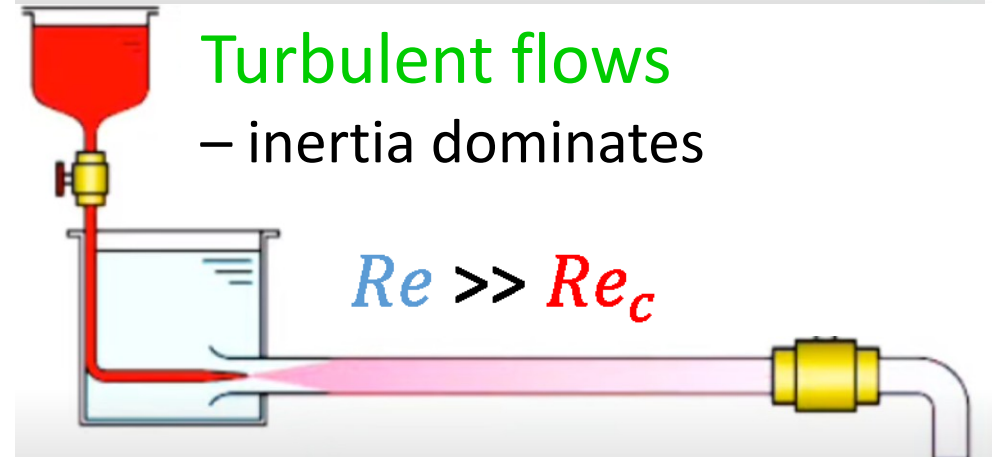

Turbulent flows
– inertia dominates

$$Re \gg Re_c$$

Turbulent mixing: very efficient heat transport

- Surface of the drop deforms and grows in area rapidly, due to turbulent flow fluctuations.
- Compared to **transport by molecular diffusion**, **mixing by turbulent flows** is thus able to enhance scalar transport by many orders of magnitude.
- Example: In a 1km thick atmospheric boundary layer, turbulent convection transfers heat at least **10⁵ more efficiently(!)**

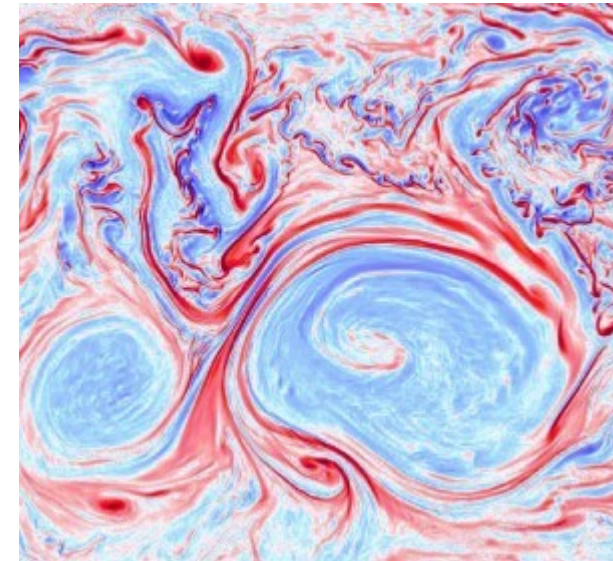



Helium

STATE OF MATTER
 GAS LIQUID ARTIFICIAL

- HYDROGEN
- ALKALI METALS
- ALKALINE-EARTH METALS
- TRANSITION METALS
- OTHER METALS

2 0
He
 Helium
 4.003

14 IVA 15 VA
 6 C -4 +2 +4 Carbon 12.011
 7 N -3 -2 -1 +1 +2 +3 +4 Nitrogen 14.007
 8 O -2 -1 +2 +3 +4 Oxygen 15.999
 14 Si -4 +2 +4 Silicon 28.086
 10 0

Home > News > Huge helium discovery 'a life-saving find'

Huge helium discovery 'a life-saving find'

PUBLISHED
28 JUN 2016

SCIENCE ENVIRONMENT RESEARCH

SHARE THIS



A new approach to gas exploration has discovered a huge helium gas field, which could address the increasingly critical shortage of this vital yet rare element.

Helium ^4He : Three fluid phases

- **“Quantum flows”**
in **superfluid (He-II)** phase

- **“Classical flows”**
in **liquid (He-I)** and **gaseous (GHe)** phases

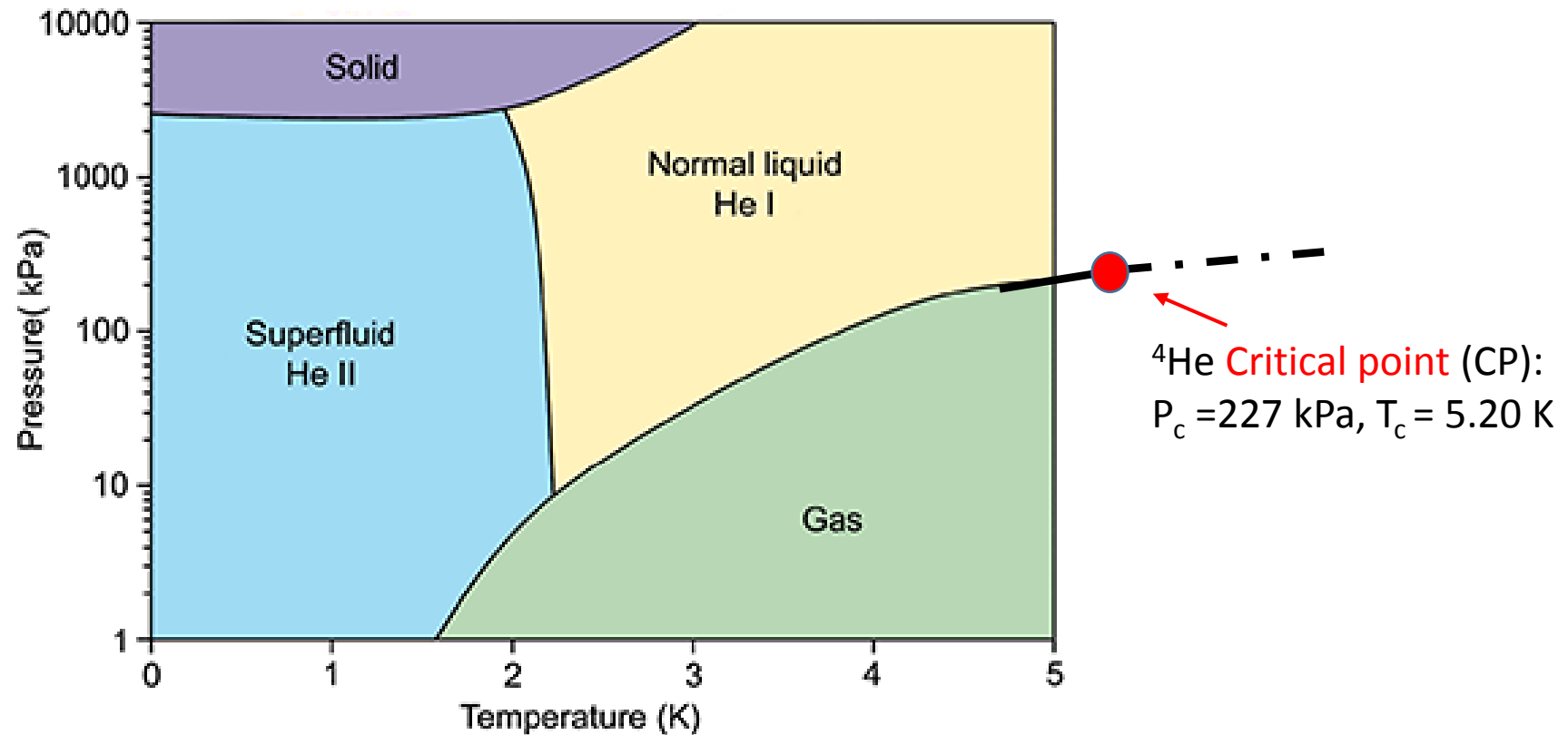

State and transport in ^4He

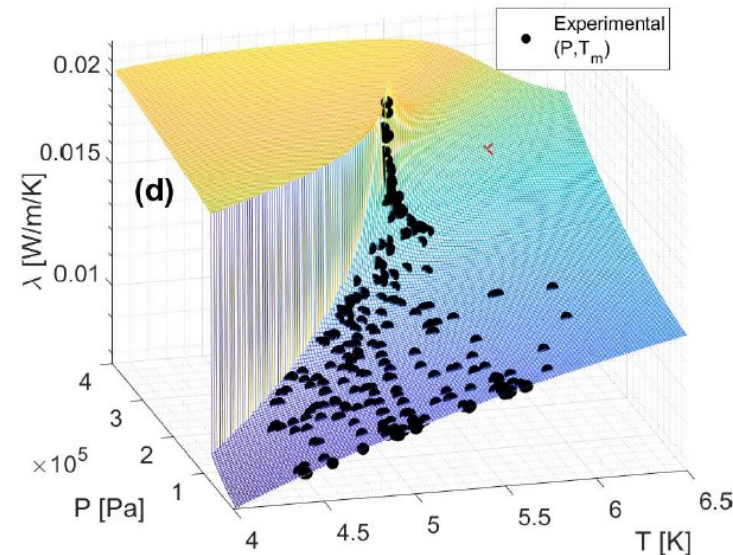
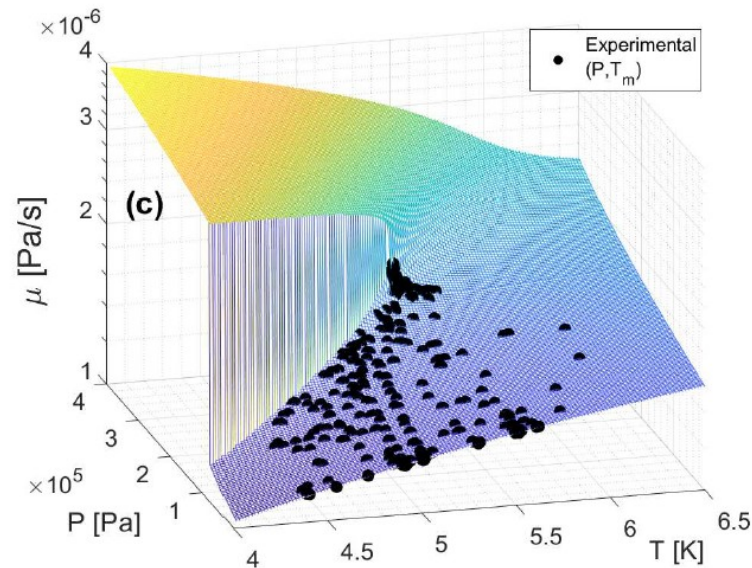
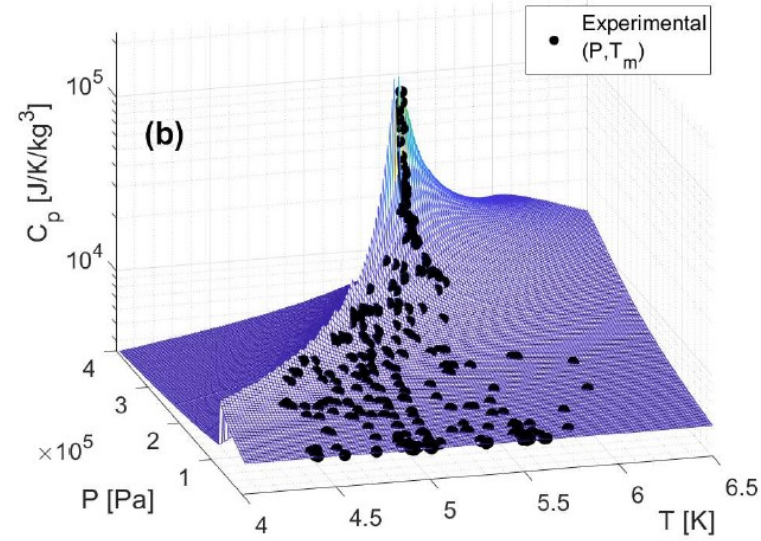
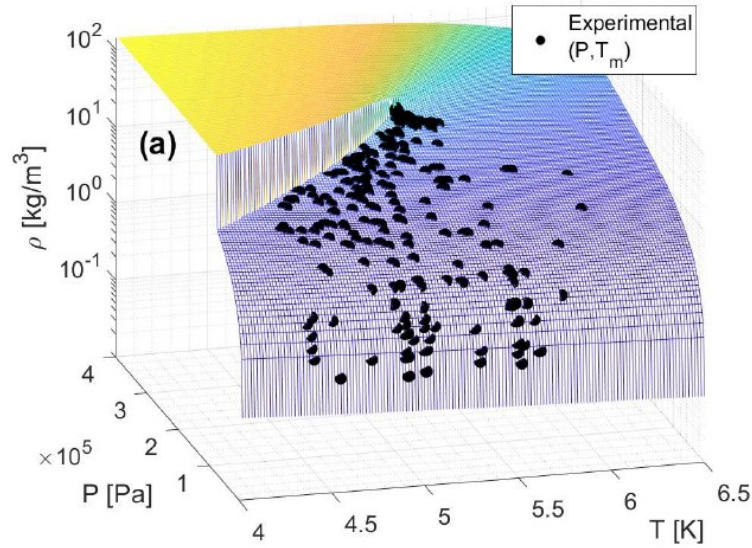

Material properties obtained from **HEPAK** database

Material property databases

DOSBox 0.74, Cpu speed: 3000 cycles, Frameskip 0, Program: XHEPAK

```
----- HEPAK -----  
Special version 3.32A for Prof. R. J. Donnelly  
Dept. of Physics, University of Oregon, Eugene.  
  
Pressure, density, temperature, and (dP/dU)t near  
the critical point are calculated using special  
equations which are valid only in that region.  
Other fluid properties, and all properties outside  
of that region, are calculated using the regular  
Hepak equations.  
  
Program written by U. ARP, R.D. MCCARTY, and B.A. HANDS.  
  
(C) Copyright (1997) by CRYODATA,  
P.O. Box 173, Louisville, CO 80027  
Phones: (v) (303) 494-6637 and (v/fax) (303) 664-1354  
All rights reserved.
```

```
For information on how to use this program, input .... ?  
otherwise, carriage return to continue..... SS
```

PRESSURE	TEMP	DENSITY	ENTROPY	CP	CONDUCT	UISC
[Pa]	[K]	[Kg/m3]	[J/Kg-K]	[J/Kg-K]	[W/m-K]	[Pa-s]

```
To select new output Columns  
and/or review parameters      input C  
To select new Units,          input U  
To review Fixed points, range input F  
To review/select Precision    input P  
Proceed: input Keyboard data  carriage return  
Proceed: Read data from a file input R  
For help on data input        input ?  
To Quit                        input Q  
your choice ..... S
```

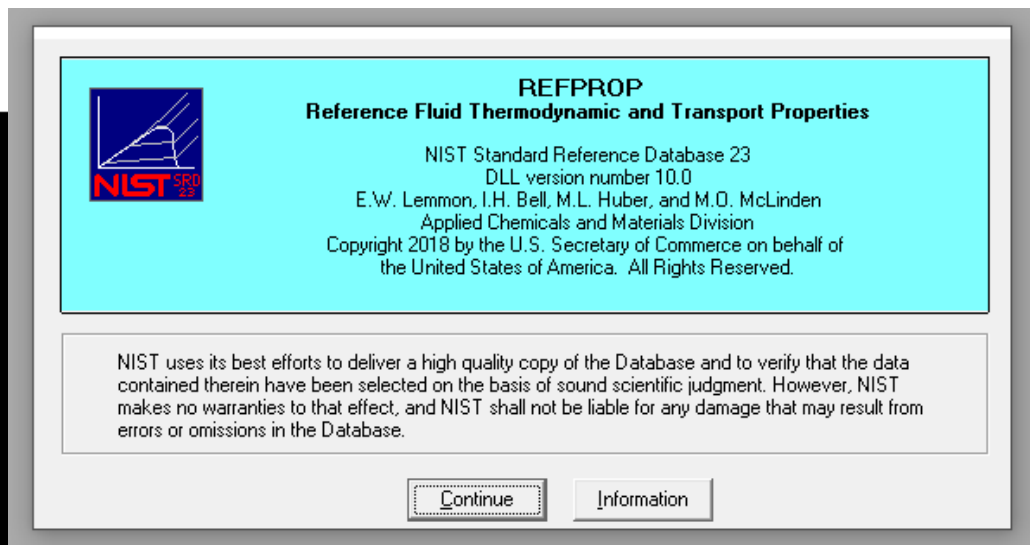

REFPROP
Reference Fluid Thermodynamic and Transport Properties

NIST Standard Reference Database 23
DLL version number 10.0
E.W. Lemmon, I.H. Bell, M.L. Huber, and M.O. McLinden
Applied Chemicals and Materials Division
Copyright 2018 by the U.S. Secretary of Commerce on behalf of
the United States of America. All Rights Reserved.

NIST uses its best efforts to deliver a high quality copy of the Database and to verify that the data contained therein have been selected on the basis of sound scientific judgment. However, NIST makes no warranties to that effect, and NIST shall not be liable for any damage that may result from errors or omissions in the Database.

Continue Information

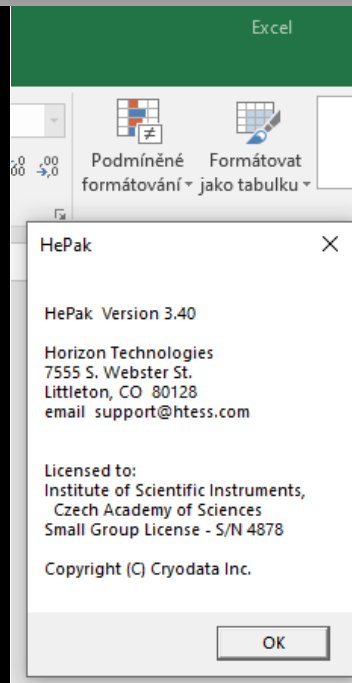

Excel

Podmíněné Formátovat
formátování jako tabulku

HePak

HePak Version 3.40
Horizon Technologies
7555 S. Webster St.
Littleton, CO 80128
email support@htess.com

Licensed to:
Institute of Scientific Instruments,
Czech Academy of Sciences
Small Group License - S/N 4878

Copyright (C) Cryodata Inc.

OK

- REFPROP
- HEPAK
- XHEPAK

Fluid properties



Plaster model of
internal energy $U(S,V)$
of a “water-like
substance”

handmade by J. C.
Maxwell (!)

for J. W. Gibbs

(found at Yale
Sloane Physics Lab.)

Cryogenics and Superconductivity group at ISI Brno

Long-time tradition in development and construction of cryogenic instruments for Basic Research:

Rayleigh Bénard convection (RBC) cell

Size $L = H = 30$ cm

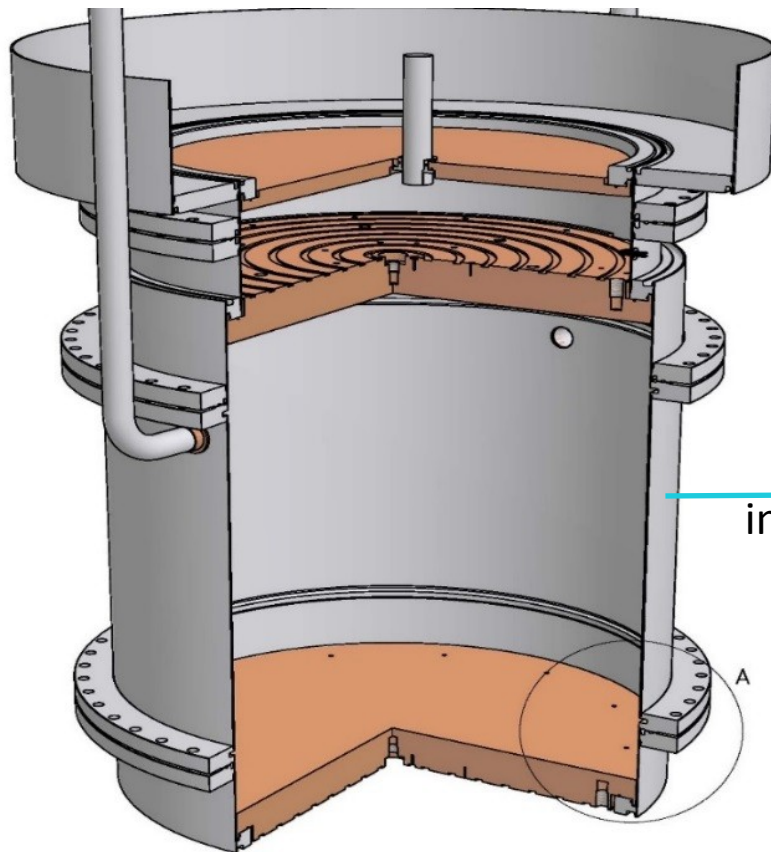

RBC cell
inside the cryostat

- Heat transport by Convection

ConEV apparatus (Convection Experimental Vessel)

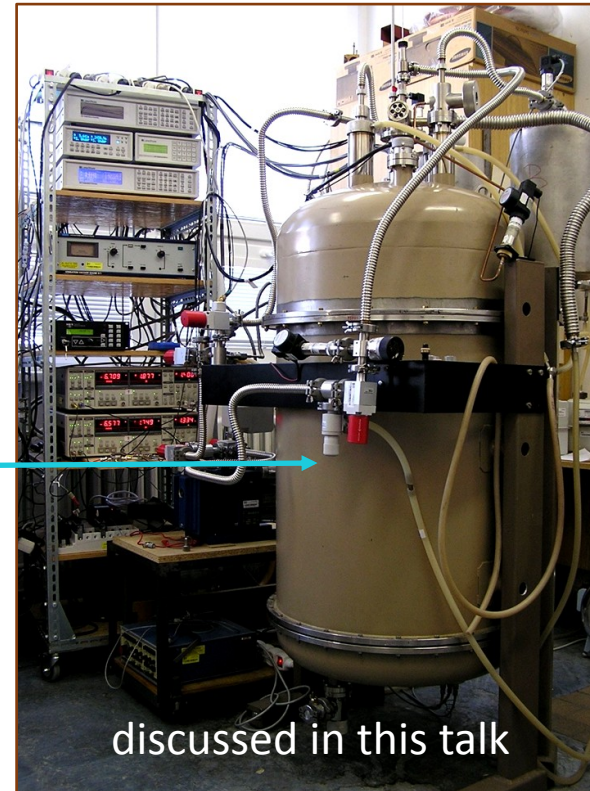

PRL **107** 014302 (2011),
PRL **109** 154301 (2012),
PRL **110** 199402 (2013),
RSI **81** 085103 (2010),
PNAS **110** 8036 (2013),
JFM **785** 270 (2015),
JFM **832** 721 (2017),
PRE **99 (R)** 011101 (2019),
...

Rayleigh-Bénard model of convection

Finite Cell: Diameter D

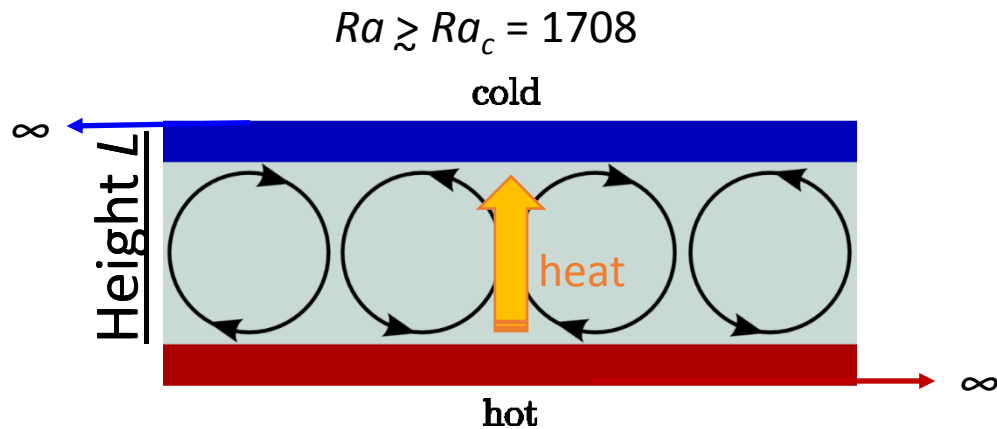

$$T_b = T_t + \Delta T$$

Oberbeck-Boussinesq (OB) fluid:

- constant **fluid properties** within ΔT :

α - thermal expansion coefficient	ν - kinematic viscosity
λ - fluid thermal conductivity	κ - thermal diffusivity

- density ρ is assumed to linearly depend on temperature T

Control parameters for RBC (adjustable):

Rayleigh number

Prandtl number

Aspect ratio

Order parameters for RBC (response of the system):

$$Nu = \frac{Q_{\text{turb}}}{Q_{\text{cond}}}$$

Nusselt number

$$Re = \frac{UL}{\nu}$$

Reynolds number

Ra, Pr, Nu, Re :
Dimensionless numbers
related to intensity of
turbulence

Equations ε

S

- Navier-Stokes equation = Newton equation for continuum - a **viscous fluid** with **pressure** and **upward buoyancy** forcing:

$$\left(\frac{\partial}{\partial t} + \mathbf{u} \cdot \nabla \right) \mathbf{u} = \nu \nabla^2 \mathbf{u} - \frac{1}{\rho_0} \nabla p + g \alpha \theta \hat{\mathbf{z}}$$

- Heat advection equation:

$$\left(\frac{\partial}{\partial t} + \mathbf{u} \cdot \nabla \right) \theta = \kappa \nabla^2 \theta$$

- Incompressibility condition:

$$\nabla \cdot \mathbf{u} = 0$$

- Heat conduction: (Fourier's law)

$$Q_{\text{cond}} = \lambda \nabla \theta$$

- Dynamical variables:

\mathbf{u} - velocity field
 θ - temperature field
 p - pressure field

- Fluid properties: (considered constant!)

α - thermal expansion coefficient
 ν - kinematic viscosity
 κ - thermal diffusivity
 λ - fluid thermal conductivity
 ρ_0 - mean density
 g - gravity acceleration

"Boussinesq equations"
of RBC

Equations and Scale-Similarity of solutions

“Non-dimensionalize” using spatial, temporal, velocity, temperature and pressure scales:

$$\left(\frac{\partial}{\partial t} + \mathbf{u} \cdot \nabla \right) \mathbf{u} = \sqrt{\frac{Pr}{Ra}} \nabla^2 \mathbf{u} - \nabla p + \theta \hat{\mathbf{z}}$$

$$\left(\frac{\partial}{\partial t} + \mathbf{u} \cdot \nabla \right) \theta = \frac{1}{\sqrt{RaPr}} \nabla^2 \theta$$

$$t \rightarrow \frac{t}{T}, \mathbf{x} \rightarrow \frac{\mathbf{x}}{L},$$
$$\mathbf{v} \rightarrow \frac{\mathbf{v}}{U}, \theta \rightarrow \frac{\theta}{\Theta}, p \rightarrow \frac{p}{P}$$

$$U = \sqrt{\alpha g \Delta \theta L}$$
$$T = \sqrt{L / \alpha g \Delta \theta}$$
$$\Theta = \Delta \theta \equiv T_b - T_t$$

Character of RBC solutions depends only on 2 essential parameters – Ra & Pr - instead of 5!

$$\alpha, \nu, \kappa, \rho_0 \text{ (and } g) \longrightarrow Ra, Pr$$

Large-scale Convection in Nature

Natural convection often occurs on large scale distances L and thus is characterized by very high values of Ra number.

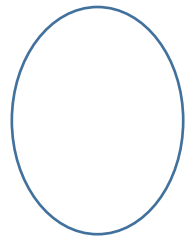
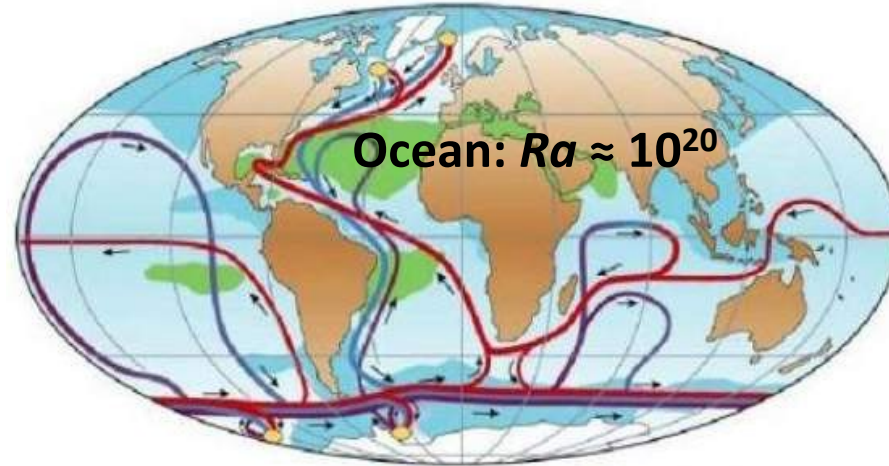

working fluid properties



system size

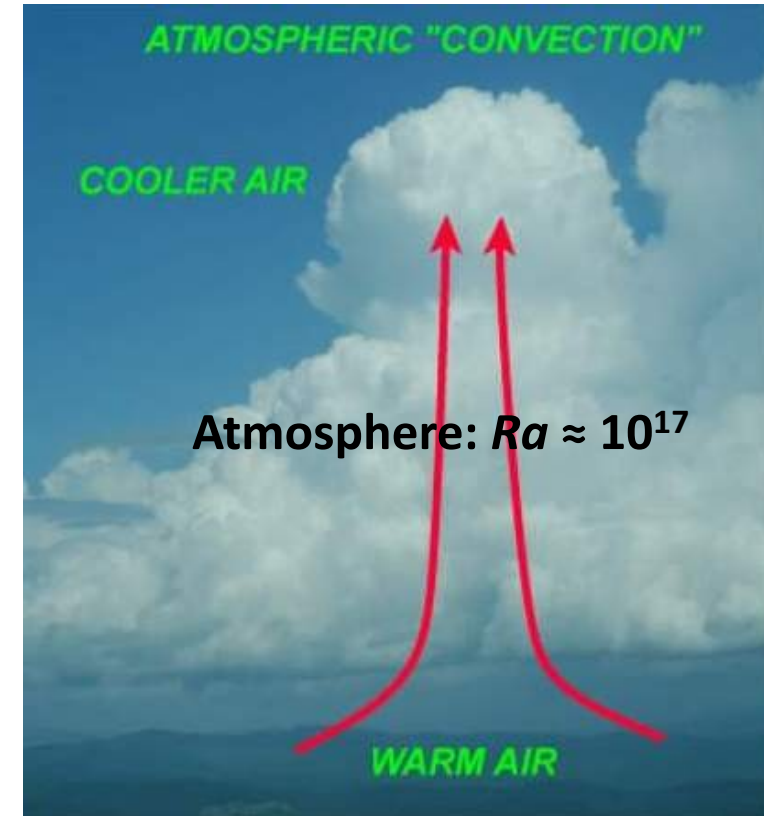
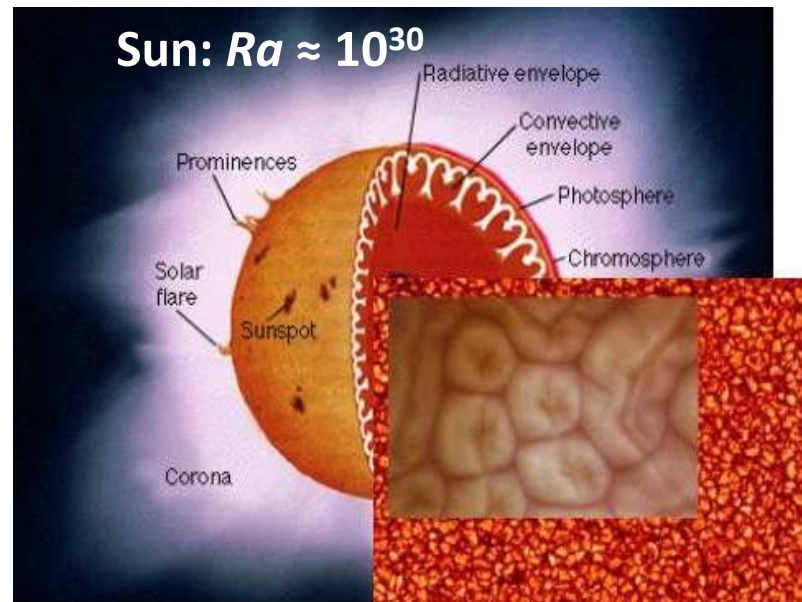

Ra values attainable with different fluids

Examples	Ra
Atmosphere	$\approx 10^{17}$
Ocean	$\approx 10^{20}$
Laboratory	$\approx 10^{17}$
Computer	$\approx 10^{11}$

Laboratory experiments: high Ra at low L .

Fluid	Temperature	$\alpha/\nu\kappa$
Air	20 C	0.122
Water	20 C	14.4
Helium ^4He (gas)	5.5 K	$1.41 \cdot 10^8$
Helium I (liquid)	2.25 K	$3.25 \cdot 10^{-5}$

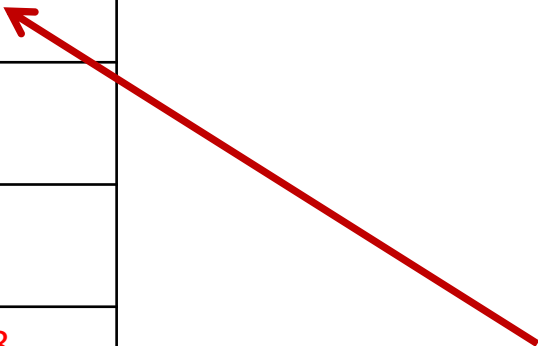

Rayleigh-Bénard Convection in ^4He

Brno cell $L = 30$ cm, Ra from 10^6 up to 10^{15}

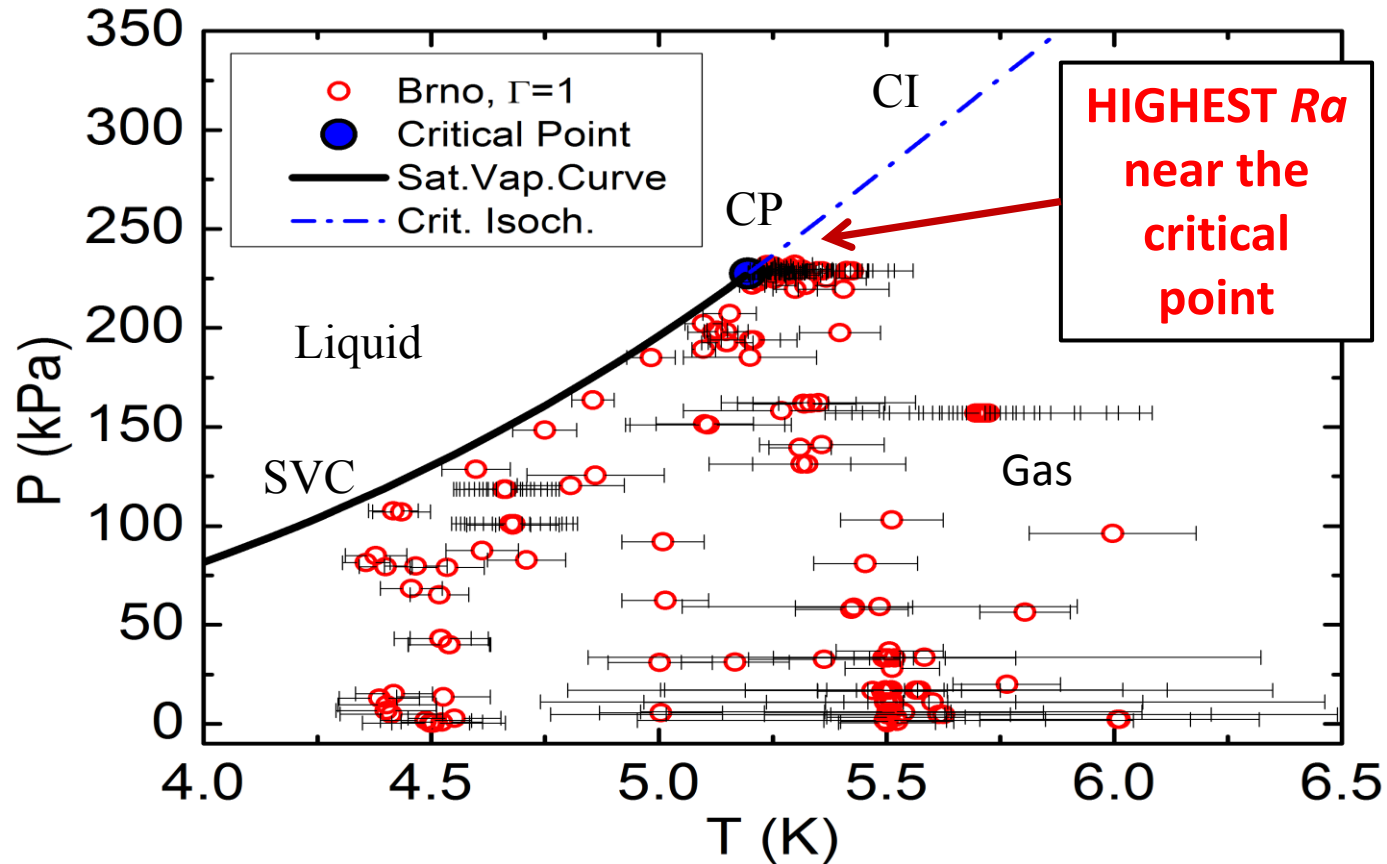

^4He Critical point (CP): $P_c = 227$ kPa, $T_c = 5.20$ K

Other interesting regions besides CP:

1. Saturated Vapor Curve (SVC)
2. Critical Isochore (CI)

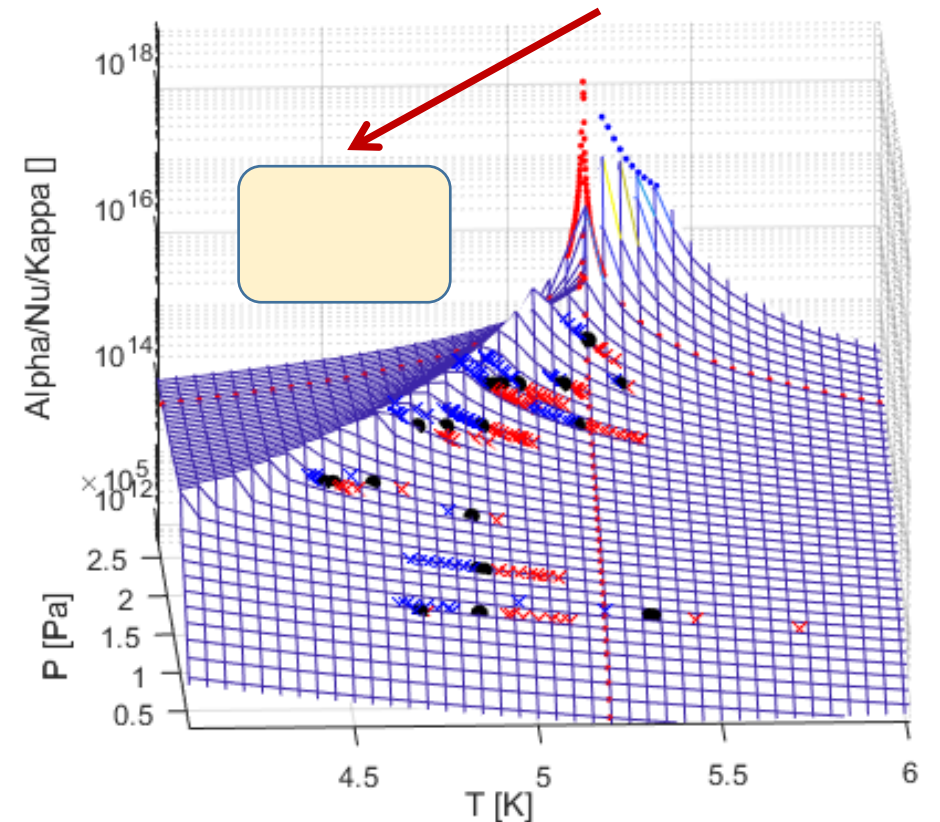

History detour #1:

Henri Benard (Ph.D. thesis, 1900)

Shadowgraph seen from above

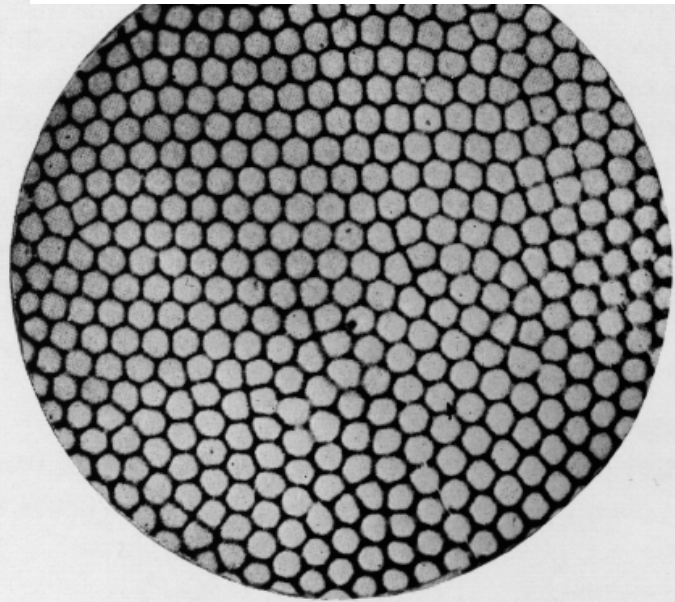

Coherent structures / patterns
observed in a fluid-filled pot
heated from below

Carried out the first systematic and quantitative study of convection in a shallow layer heated from below, and studied the associated formation of convection **PATTERNS** systematically and quantitatively

E. Bouty : “Bénard did not make any effort to provide general theoretical explanations ...”

The report of the thesis committee stated “.... *though Bénard’s main thesis was very peculiar, it did not bring significant elements to our knowledge. ... the thesis should not to be considered as the best of what Bénard could produce.*”

...it is not
as simple ...

History
detour
#2:

PHILOSOPHICAL MAGAZINE
AND
JOURNAL OF SCIENCE.

[SIXTH SERIES]

DECEMBER 1916.

LIX. *On Convection Currents in a Horizontal Layer of Fluid, when the Higher Temperature is on the Under Side*
By Lord RAYLEIGH, O.M., F.R.S.*

THE present is an attempt to examine how far the interesting results obtained by Bénard † in his careful and skilful experiments can be explained theoretically. Bénard worked with very thin layers, only about 1 mm. deep, standing on a levelled metallic plate which was maintained at a uniform temperature. The upper surface was usually f



Lord Rayleigh

- Formulated equations for system with ∞ plates
- Predicted critical value of the control parameter (now “Rayleigh number”) for conduction - convection transition

$$Ra_c = 1708$$

Experimentally confirmed with high accuracy

History
detour
#3:

Edward Lorer

ction

was rep
sent
8481

A METHOD OF APPLYING THE HYDRODYNAMIC AND THERMODYNAMIC
EQUATIONS TO ATMOSPHERIC MODELS

by

Edward Norton Lorenz

A.B., Dartmouth College
(1938)

A.M., Harvard University
(1940)

S.M., Massachusetts Institute of Technology
(1943)

SUBMITTED IN PARTIAL FULFILLMENT OF THE
REQUIREMENTS FOR THE DEGREE OF
DOCTOR OF SCIENCE

at the

MASSACHUSETTS INSTITUTE OF TECHNOLOGY
(1948)

Signature of Author.....
Department of Meteorology, Jan. 9, 1948

Certified by....., Thesis Supervisor

.....
Chairman, Department Committee on Graduate Students

$$\frac{dx}{dt} = \sigma(y - x),$$
$$\frac{dy}{dt} = x(\rho - z) - y,$$
$$\frac{dz}{dt} = xy - \beta z.$$

Simple 3D dynamical
system derived from
Boussinesq equations of
RBC

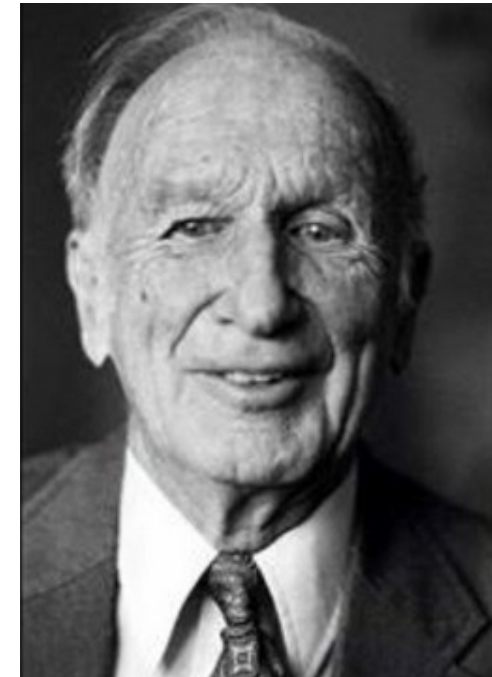

Lorenz system as simplified Rayleigh–Bénard convection

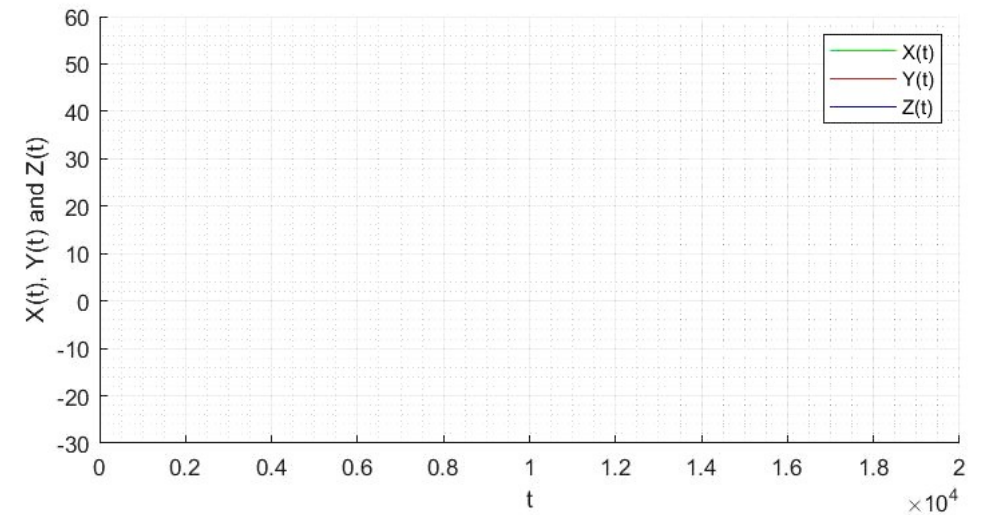
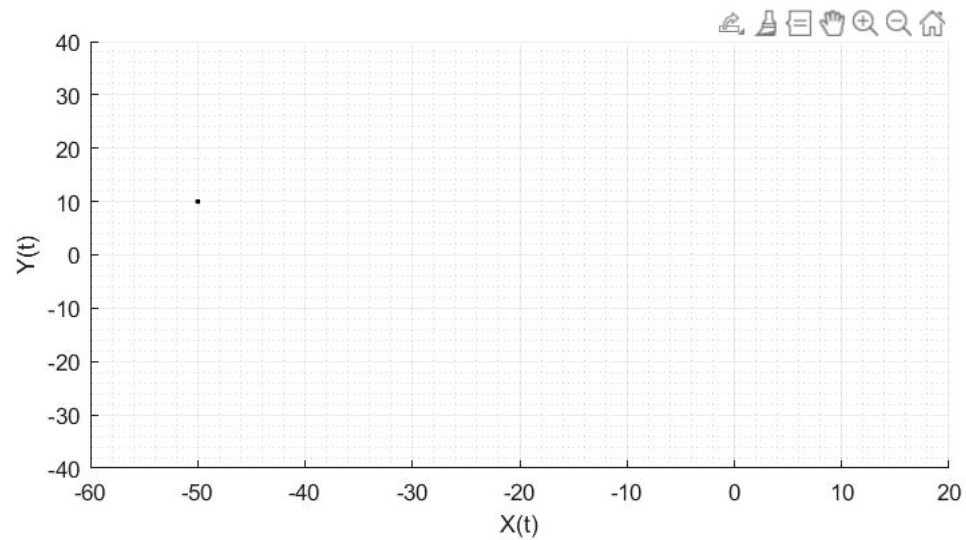
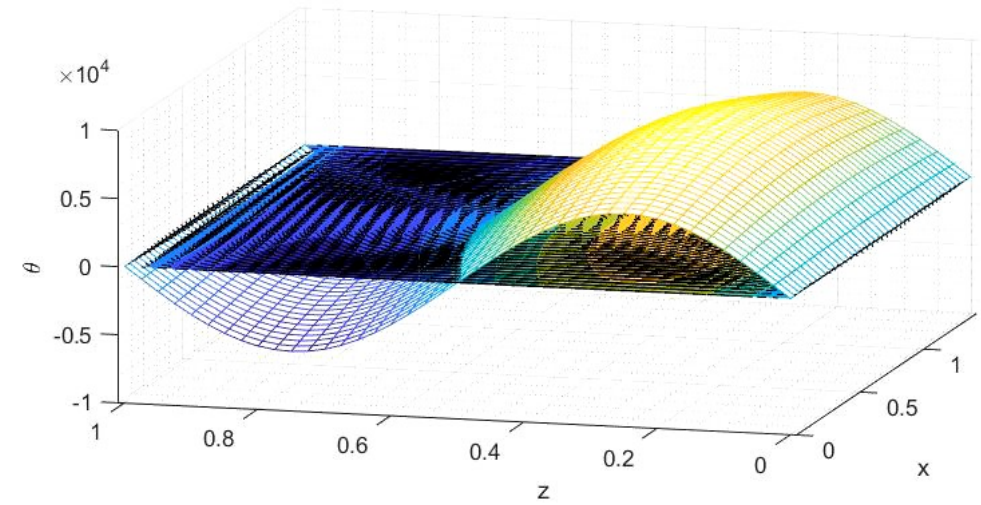
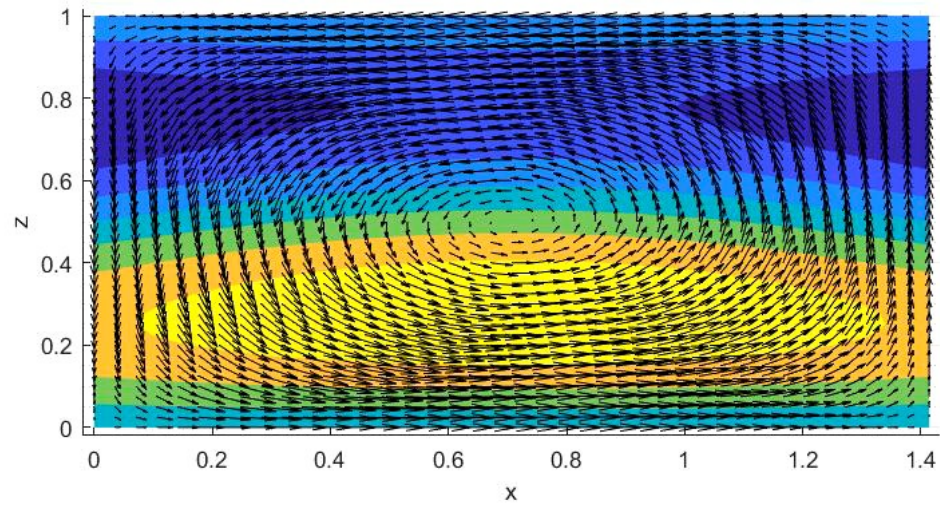

$\rho = 0.1$

fazovy portret Lorenzova atraktor

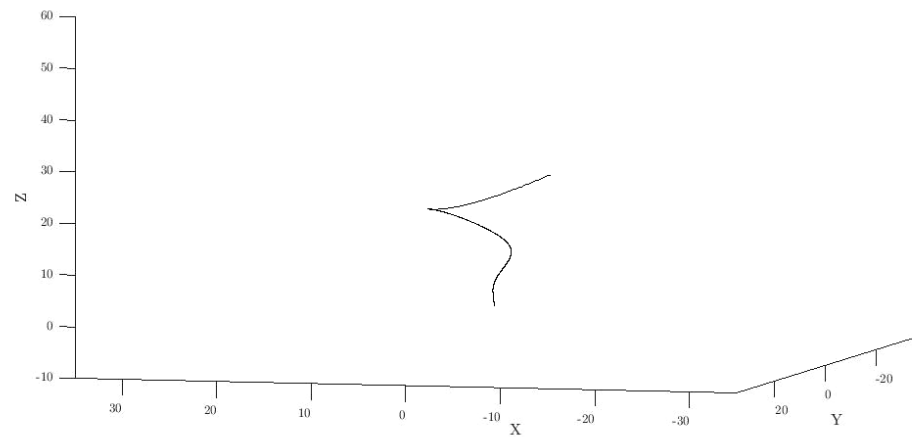

λ bez zavislosti na case

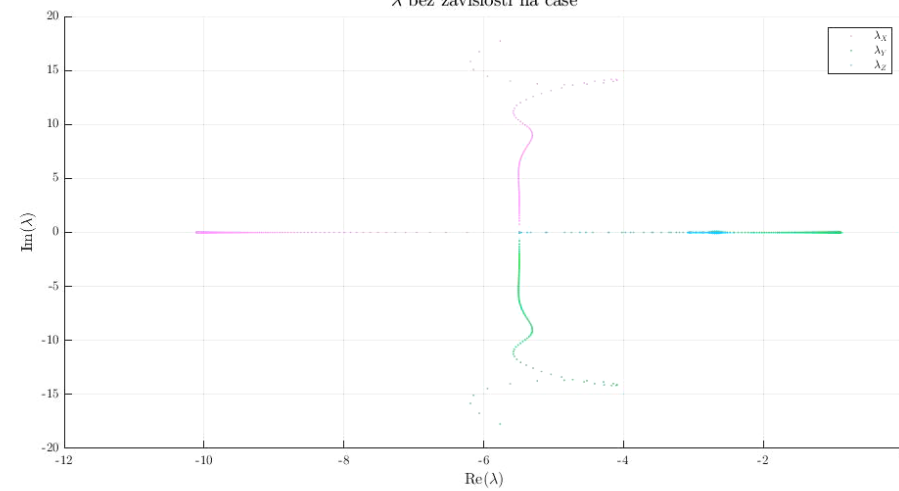

jednotlive slozky Lorenzova atraktor v zavislosti na case

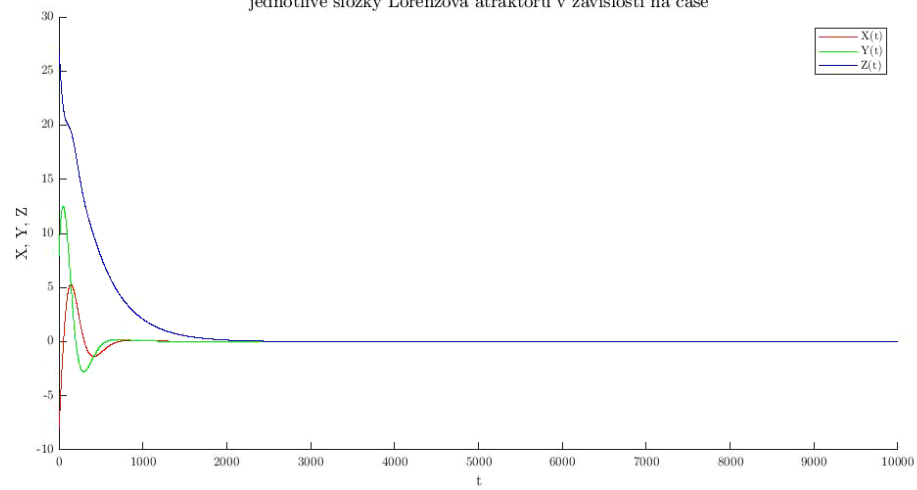

realna cast λ v zavislosti na case

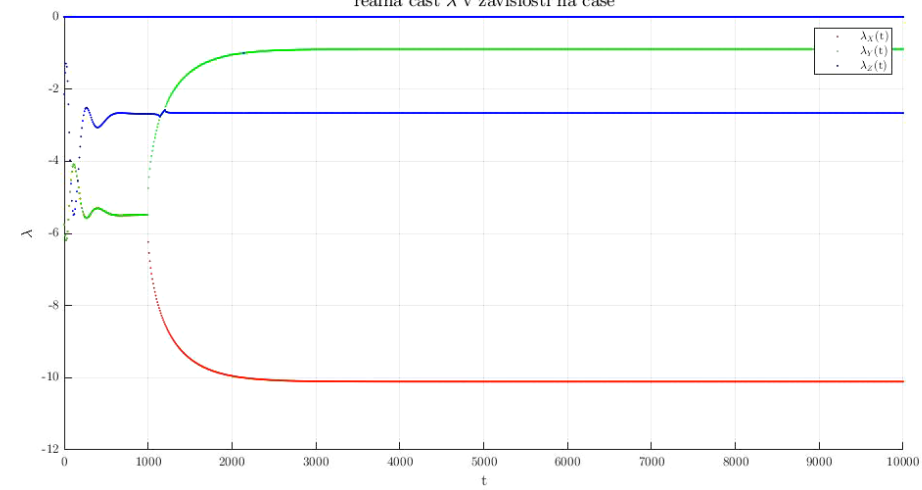

$\rho = 0.1$

fazovy portret Lorenzova atraktoru

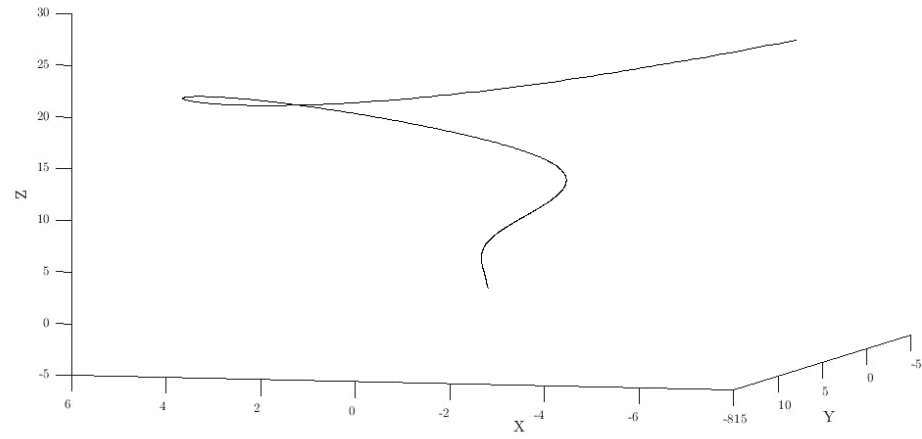

λ bez závislosti na case

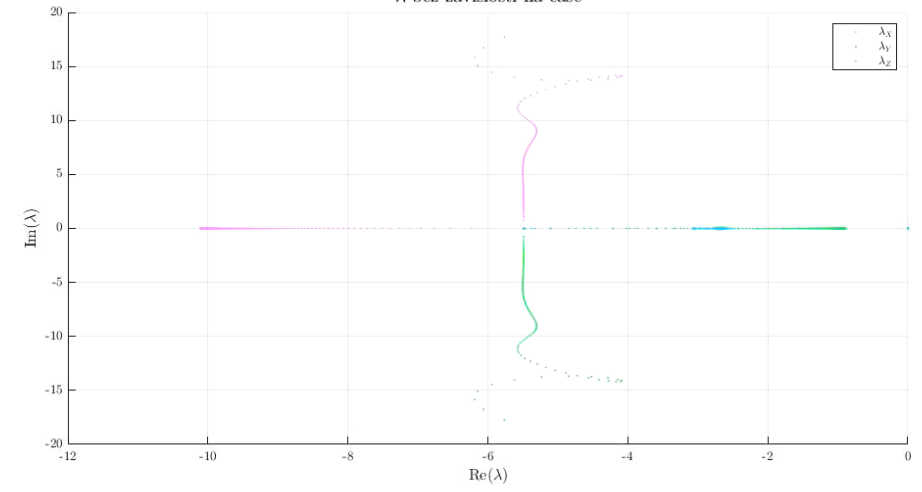

jednotlive složky Lorenzova atraktoru v závislosti na case

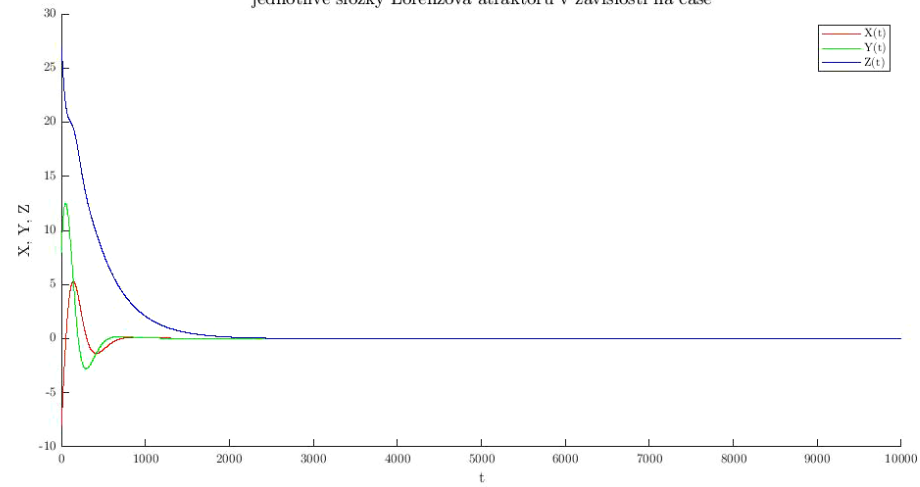

realna cast λ v závislosti na case

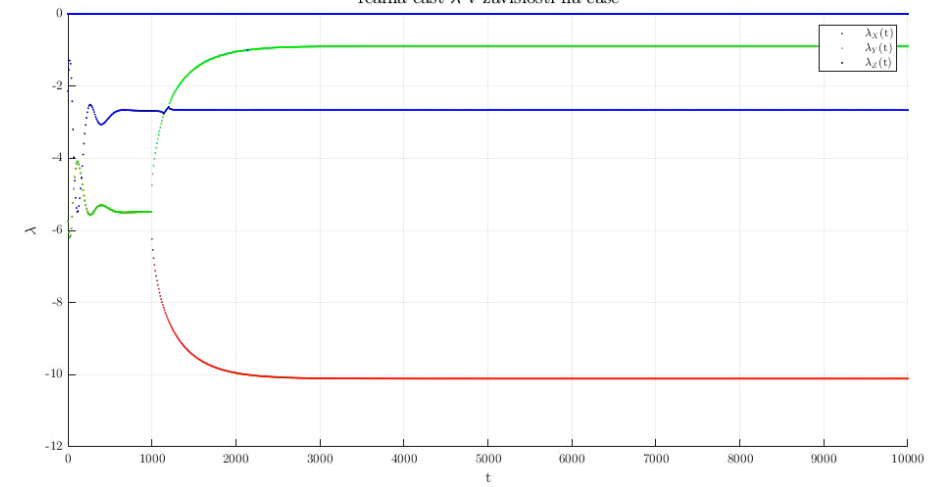

Regimes of RBC: Heat Transport

Nusselt number Nu

(dimensionless heat transfer coefficient):

Critical point #1:
Onset of (laminar) Convection

“Critical point #2”:
Transition to Turbulence

Power law dependences in turbulent regime(s)
are good approximation

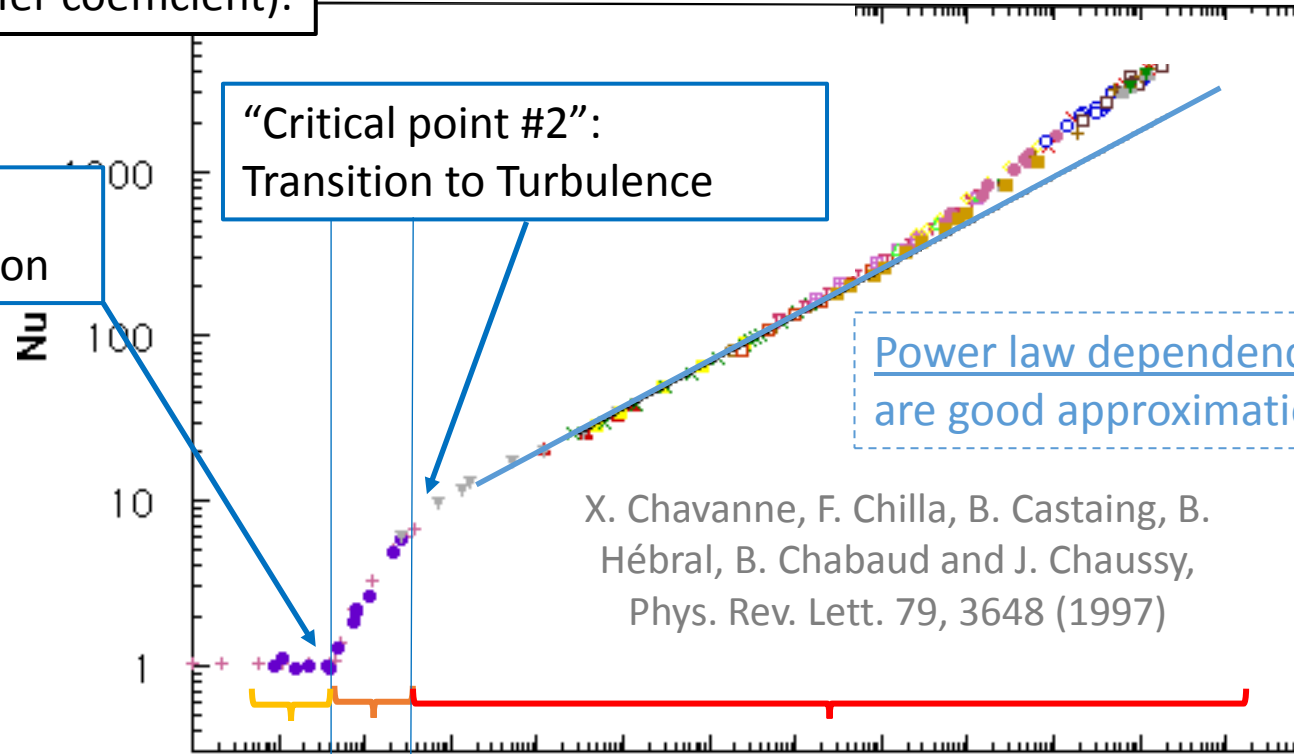

Conduction

Laminar convection

Turbulent convection

Ra

Regimes of RBC: Heat Transport

Nusselt number Nu
(dimensionless heat transfer coefficient):

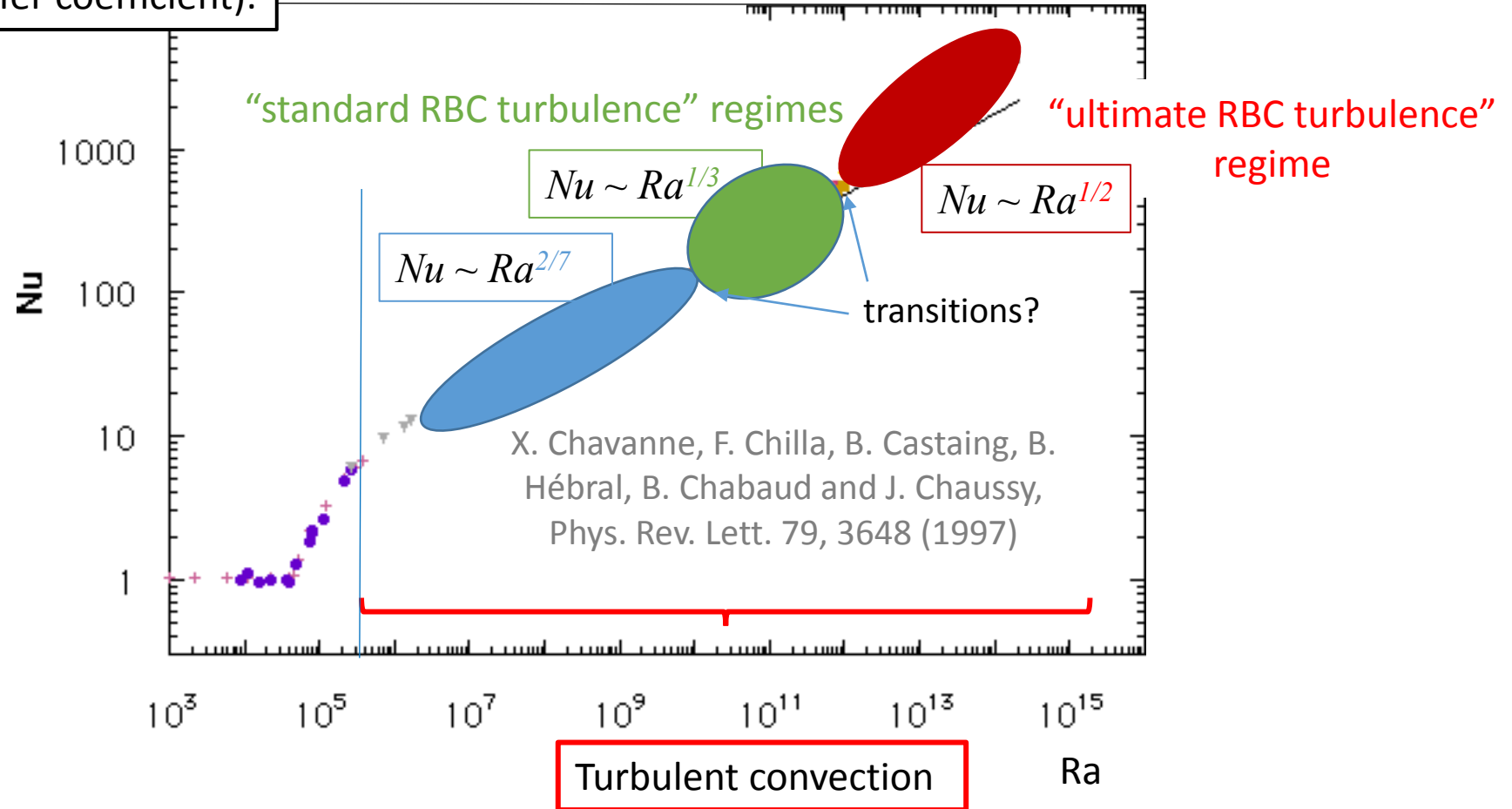

Ultimate regime of heat transport in RBC

“Standard turbulent” RBC

Malkus, Priestley, Spiegel (1954)

Shraiman and Siggia (1990)

laminar boundary layers (BL) + weak or no dependence on Pr

Ultimate / asymptotic turbulent RBC



THE PHYSICS OF FLUIDS

VOLUME 5, NUMBER 11

NOVEMBER 1962

Turbulent Thermal Convection at Arbitrary Prandtl Number

ROBERT H. KRAICHNAN

Courant Institute of Mathematical Sciences, New York University, New York
(Received May 24, 1962)

$$Nu \sim Ra^{1/2}$$

weak dependence on Pr

$$Ra^* \approx 10^{21} - 10^{24}$$

- fully turbulent boundary layers
- ballistic heat transfer independent of κ and ν

Extrapolations to large-scale flows?

exponents $\gamma = 1/3$ and $\gamma = 1/2$

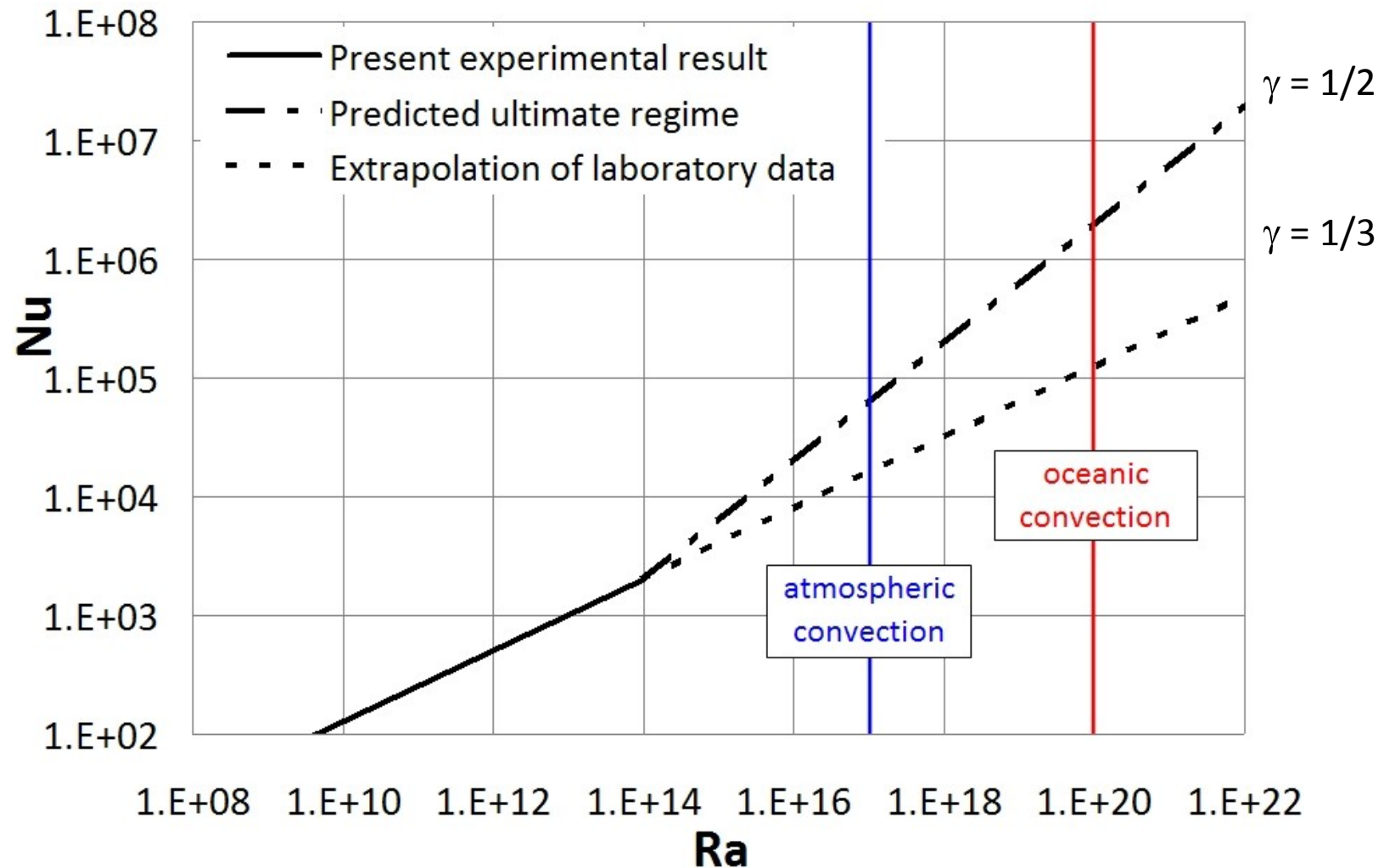

Confirmation of existence of the ultimate regime is great challenge in this field of study!

OBSERVED...?

VOLUME 79, NUMBER 19

PHYSICAL REVIEW LETTERS

10 NOVEMBER 1997

Observation of the Ultimate Regime in Rayleigh-Bénard Convection

X. Chavanne,¹ F. Chillà,² B. Castaing,¹ B. Hébral,¹ B. Chabaud,¹ and J. Chaussey¹

¹Centre de Recherches sur les Très Basses Températures, Laboratoire Associé à l'Université Joseph Fourier, C.N.R.S., B.P. 166, 38042 Grenoble-Cedex 9, France

²Laboratoire de Physique de l'École Normale Supérieure de Lyon, 46 Allée d'Italie, 69364 Lyon-Cedex 07, France

(Received 8 July 1997)

In a low temperature He gas Rayleigh-Bénard experiment, Rayleigh numbers from 10^3 to more than 10^{14} are explored. Local velocity is estimated through the time lag between two closely temperature probes. This allows characterizing of the high Rayleigh regime ($Ra > 10^{11}$) as a fully turbulent one, possibly corresponding to the asymptotic regime predicted by R. Kraichnan [Phys. Fluids 5, 1374 (1962)]. [S0031-9007(97)04440-2]

Cryogenic ⁴He experiment
(Grenoble)

Selected for a Viewpoint in Physics

PRL 108, 024502 (2012)

PHYSICAL REVIEW LETTERS

week ending
13 JANUARY 2012



Transition to the Ultimate State of Turbulent Rayleigh-Bénard Convection

Xiaozhou He,¹ Denis Funfschilling,² Holger Nobach,¹ Eberhard Bodenschatz,^{1,3,4} and Guenter Ahlers⁵

¹Max Planck Institute for Dynamics and Self Organization, D-37073 Göttingen, Germany

²LRGP CNRS - GROUPE ENSIC, BP 451, 54001 Nancy Cedex, France

³Institute for Nonlinear Dynamics, University of Göttingen, D-37073 Göttingen, Germany

⁴Laboratory of Atomic and Solid-State Physics and Sibley School of Mechanical and Aerospace Engineering,

Cornell University, Ithaca, New York 14853

⁵Department of Physics, University of California, Santa Barbara, California 93106, USA

(Received 7 September 2011; published 9 January 2012)

Room-temperature high-pressure SF₆ experiment
(Goettingen) PHYSICAL REVIEW LETTERS 120, 144502 (2018)

Transition to the Ultimate Regime in Two-Dimensional Rayleigh-Bénard Convection

Xiaojue Zhu,^{1,*} Varghese Mathai,¹ Richard J. A. M. Stevens,¹ Roberto Verzicco,^{2,1} and Detlef Lohse^{1,3,†}

¹Physics of Fluids Group and Max Planck Center Twente for Complex Fluid Dynamics,

MESA+Institute and J. M. Burgers Centre for Fluid Dynamics, University of Twente,

P.O. Box 217, 7500AE Enschede, The Netherlands

²Dipartimento di Ingegneria Industriale, University of Rome "Tor Vergata", Via del Politecnico 1, Roma 00133, Italy

³Max Planck Institute for Dynamics and Self-Organization, 37077 Göttingen, Germany

Numerical simulation in 2D (Twente, Rome, Goettingen)

NO...?

NATURE | VOL 404 | 20 APRIL 2000 | www.nature.com

articles

Turbulent convection at very high Rayleigh numbers

Cryogenic ⁴He experiment (Oregon)

J. J. Niemela*, L. Skrbek*, K. R. Sreenivasan*† & R. J. Donnelly*

*Cryogenic Helium Turbulence Laboratory, Department of Physics, University of Oregon, Eugene, Oregon 97403, USA

†Mason Laboratory, Yale University, New Haven, Connecticut 06520-8286, USA

J. Fluid Mech. (2015), vol. 785, pp. 270–282. © Cambridge University Press 2015

270

Turbulent
dissipation
convection
asymptotic
representation
orders of
entire
we find
and pr

doi:10.1017/jfm.2015.638

Driving to
of turbulent
ence of an
er (Nu),
over eleven
ata, over the
n particular,
ons with Ra,

Has the ultimate state of turbulent thermal convection been observed?

Cryogenic ⁴He experiment (Brno)

L. Skrbek^{1,†} and P. Urban²

¹Faculty of Mathematics and Physics, Charles University, Ke Karlovu 3, 121 16 Prague, Czech Republic

²Institute of Scientific Instruments ASCR, v.v.i., Královopolská 147, 612 00 Brno, Czech Republic

(Received 3 July 2015; revised 10 September 2015; accepted 25 October 2015)

PHYSICAL REVIEW E 99, 011101(R) (2019)

Rapid Communications

Cryogenic ⁴He experiment (Brno)

Elusive transition to the ultimate regime of turbulent Rayleigh-Bénard convection

P. Urban,* P. Hanzelka, T. Králík, M. Macek, and V. Musilová

Institute of Scientific Instruments, The Czech Academy of Sciences, Královopolská 147, Brno, Czech Republic

L. Skrbek[†]

Faculty of Mathematics and Physics, Charles University, Ke Karlovu 3, Prague, Czech Republic



(Received 5 June 2018; published 23 January 2019)

Transitions observed at ISI Brno:

1. Transition at $Ra > \sim 10^{14}$: Ultimate regime transition or NOB effects ?
2. Transition at $Ra \sim 10^{10}-10^{11}$: ?

NOB: $T_m \neq T_c$: BL asymmetry

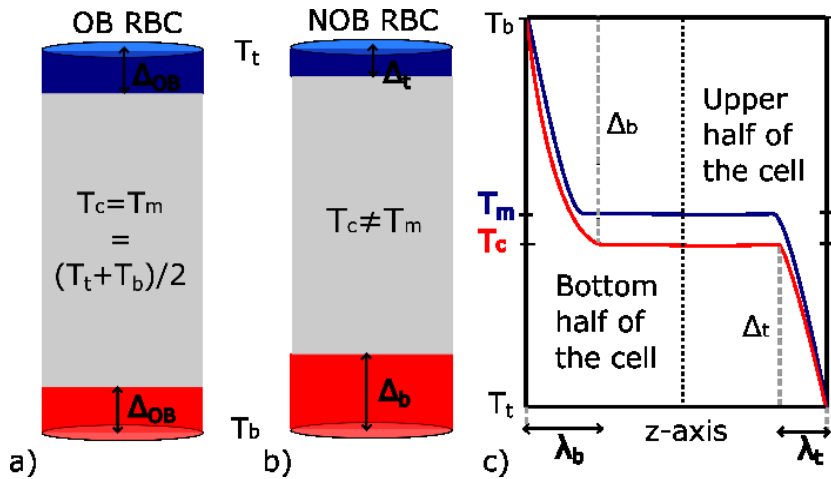

J. Drahotský, P. Hanzelka, V. Musilová,
MM, R. du Puits and P. Urban
EPJ Conf S. **180**, 02020 (2018)

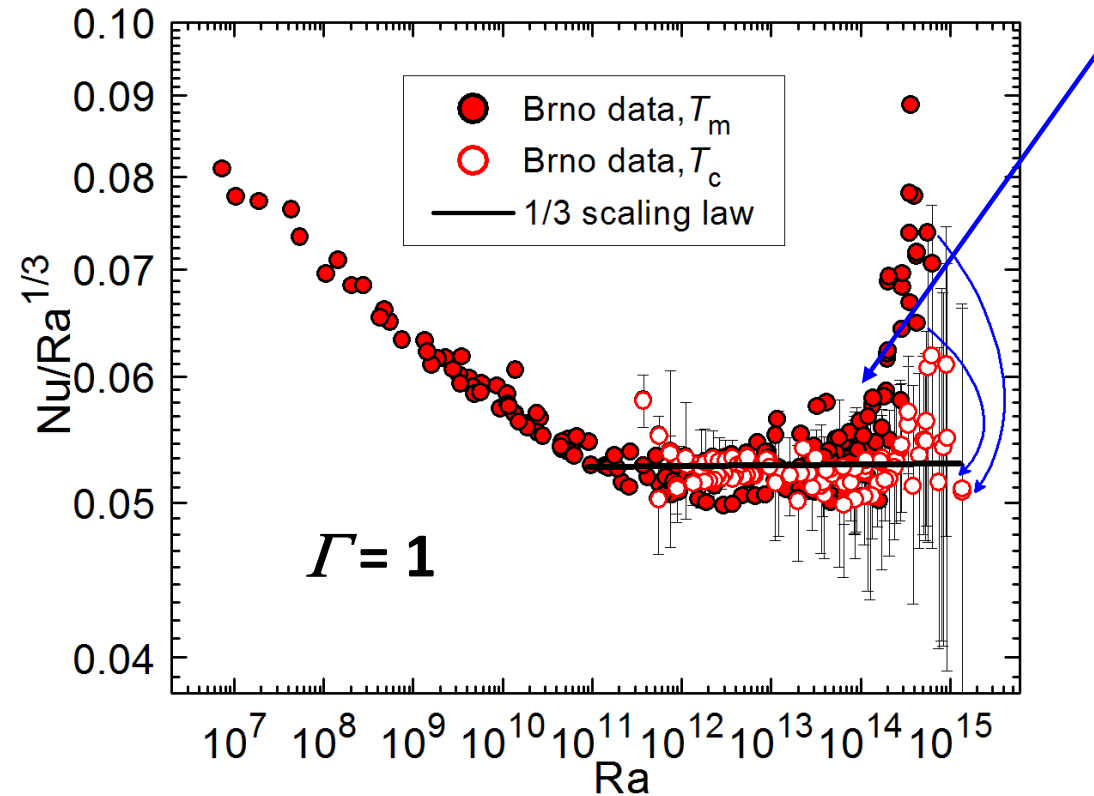

NOB effects
near the
Critical Point
of ${}^4\text{He}$

P. Urban, P. Hanzelka, T. Kralik, V. Musilova, A. Srnka and L. Skrbek,
Phys. Rev. Lett. **109**, 154301 (2012).

P. Urban, P. Hanzelka, T. Králík, MM, V. Musilová, L. Skrbek
Phys. Rev. E **99**, 011101 (R) (2019).

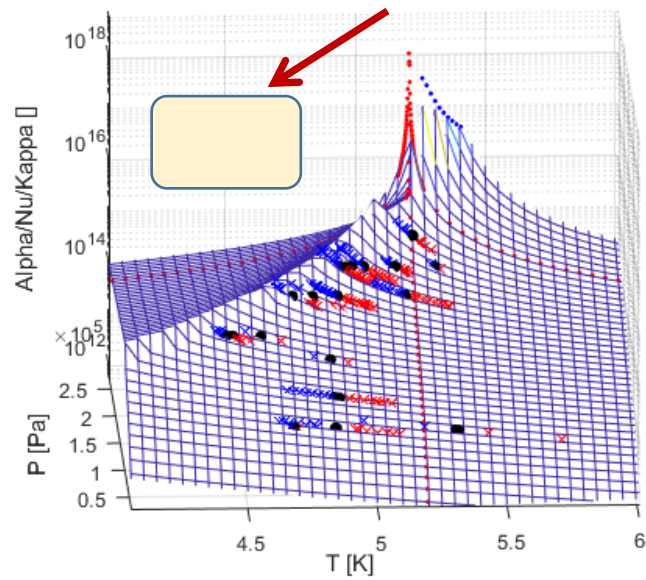
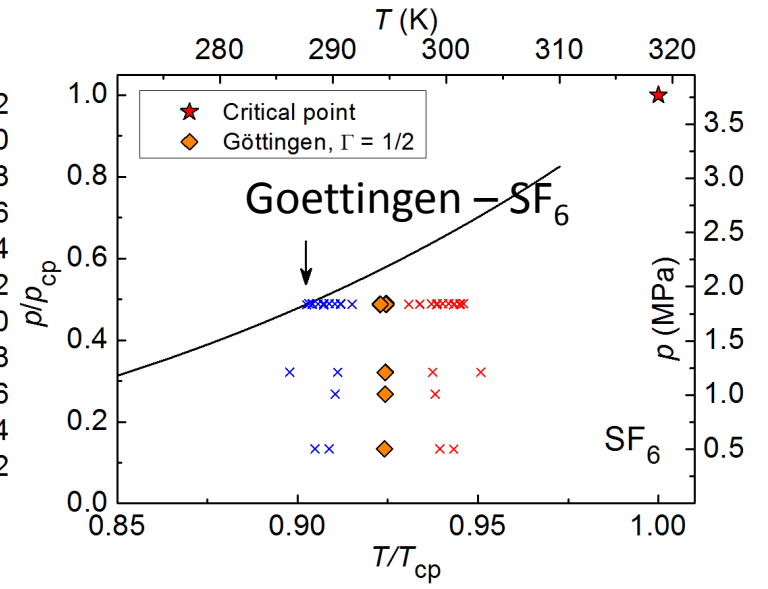
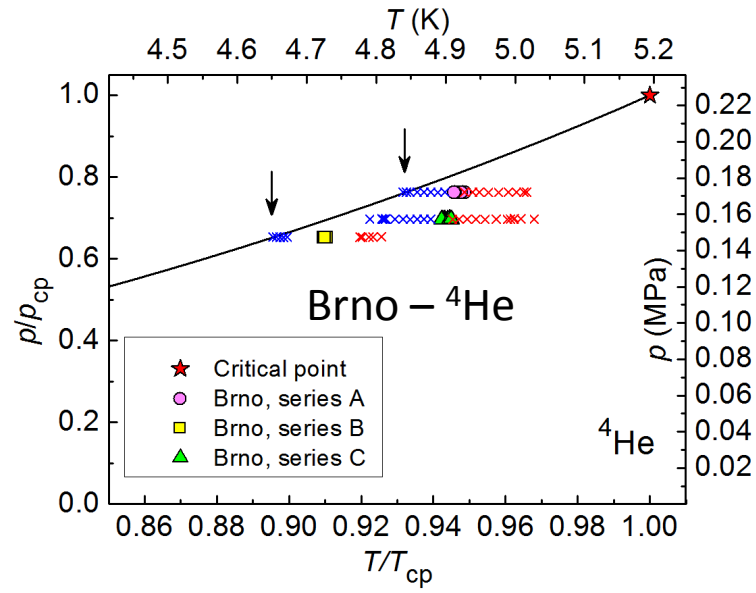
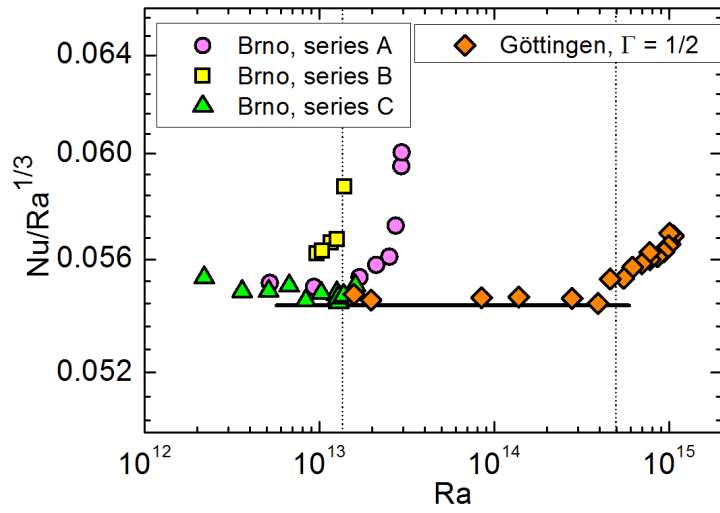

NOB effects
near the
Saturation Curves of
 ^4He and SF_6

PHYSICAL REVIEW E **99**, 011101(R) (2019)

Rapid Communications

Elusive transition to the ultimate regime of turbulent Rayleigh-Bénard convection

P. Urban,^{*} P. Hanzelka, T. Králík, M. Macek, and V. Musilová
Institute of Scientific Instruments, The Czech Academy of Sciences, Královopolská 147, Brno, Czech Republic

L. Skrbek[†]
Faculty of Mathematics and Physics, Charles University, Ke Karlovu 3, Prague, Czech Republic

(Received 5 June 2018; published 23 January 2019)

Transitions observed at ISI Brno:

1. Transition at $Ra > \sim 10^{14}$: Ultimate regime transition or NOB effects ?
2. Transition at $Ra \sim 10^{10}-10^{11}$: ?

Transition: $Nu \sim Ra^{2/7} - Ra^{1/3}$

Change in shape of the coherent flow structure - **the mean wind**

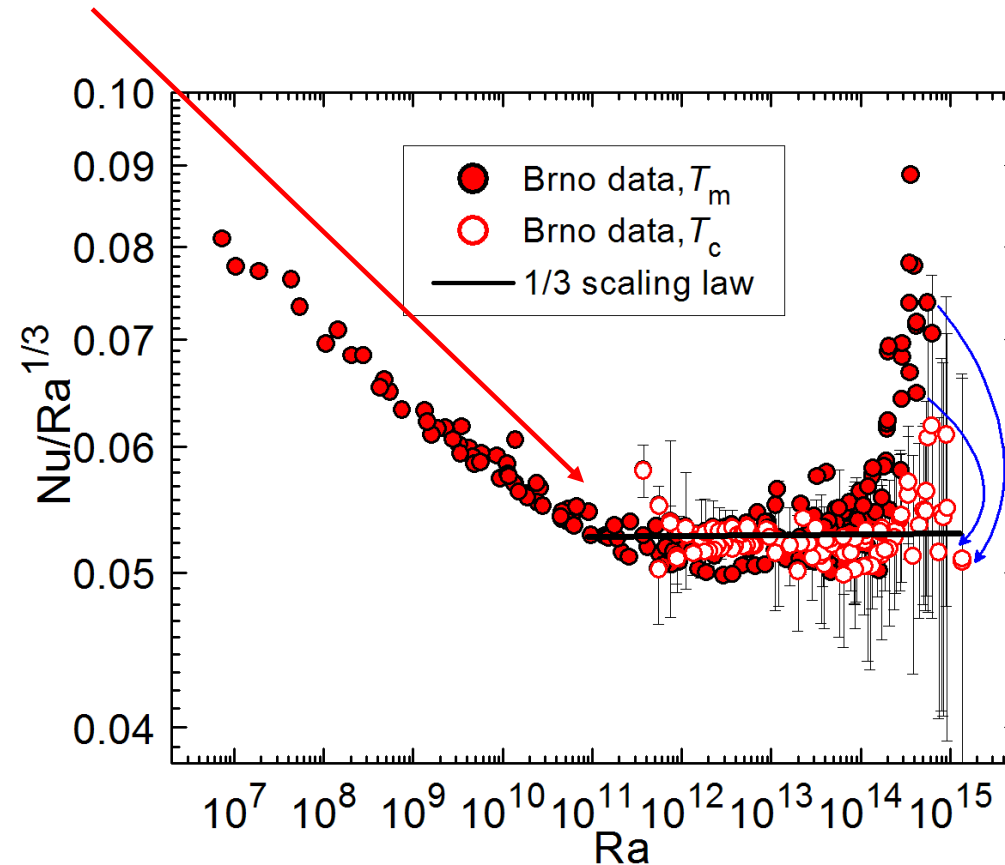
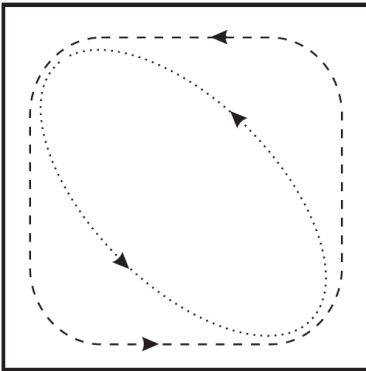

V. Musilová, T. Králík, M. La Mantia, MM., P. Urban, L. Skrbek.
J. Fluid. Mech. 832, 721 – 744 (2017).

Regimes of RBC: Coherent structures

Onset of (laminar) Convection:
- Different forms of coherent structures seen (Pattern formation)

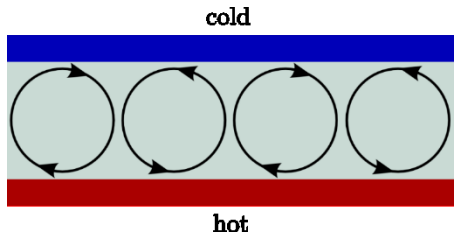

Regimes near onset of convection:
Studied in cells with $\Gamma \gg 1$.

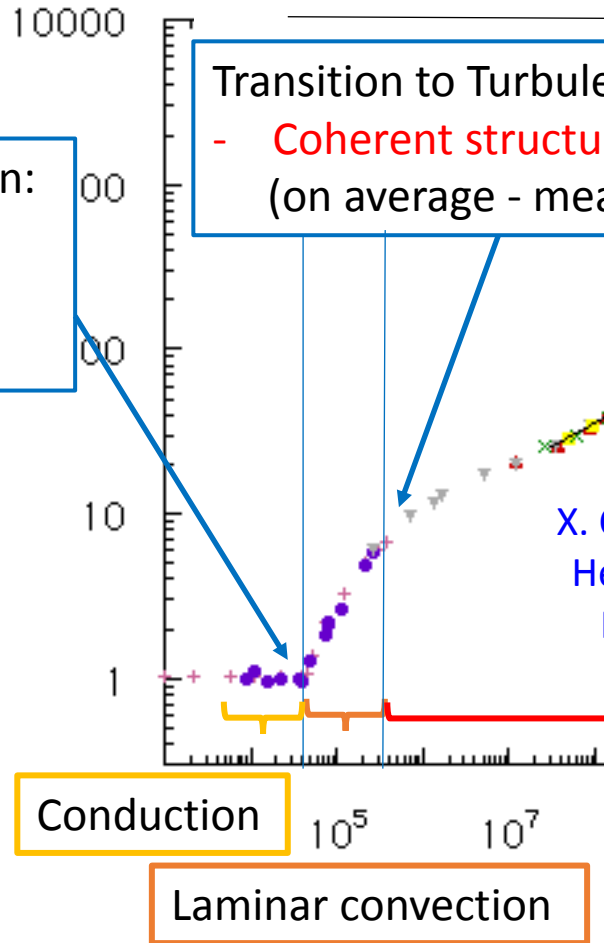

Figure 5 (a) ISR and (b) SDC at $\varepsilon = 0.92$; (c) ISR at $\varepsilon = 2.99$ and (d) SDC at $\varepsilon = 3.0$; (e) oscillatory ISR and (f) oscillatory SDC at $\varepsilon = 5.08$. For this experiment $\Gamma = 50$ and $\sigma = 1.03$. For each pair of pictures only the initial conditions were different. The insets show a magnified view of the oscillating rolls. Whereas in (e) the oscillations travel from bottom to top, in (f) the oscillations are very disordered. Often rotating spoke pattern are found, as seen in the insert of (f). From Cakmur et al (1997a).

Adapted from Bodenschats et al., Annu.Re.Fluid.Mech (2000)

Shadowgraph

Low Ra - instant. snapshot (spiral defect chaos - SDC)

Moderate Ra - instant. snapshot (disorder, strong fluctuations)

Moderate Ra

Zwirner & Shishkina, JFM 850, 984 (2018)

Emran, Schumacher, JFM 776, 96 (2015) MM, Schumacher, in preparation

Reynolds measurements at ISI Brno: Temperature fluctuations in the turbulent bulk

Four small cubic Ge thermistors ($T_1 - T_4$) near sidewalls

with respect to LSC direction: T_1, T_3 – “leading sensors”
 T_2, T_4 – “trailing sensors”

→ Temperature fluctuations time series ($\delta T \sim 1\text{mK}$)

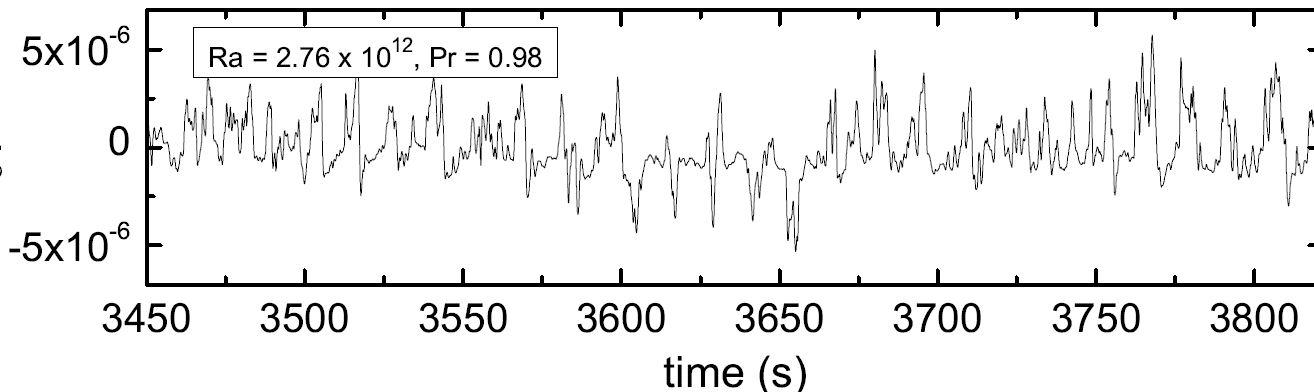
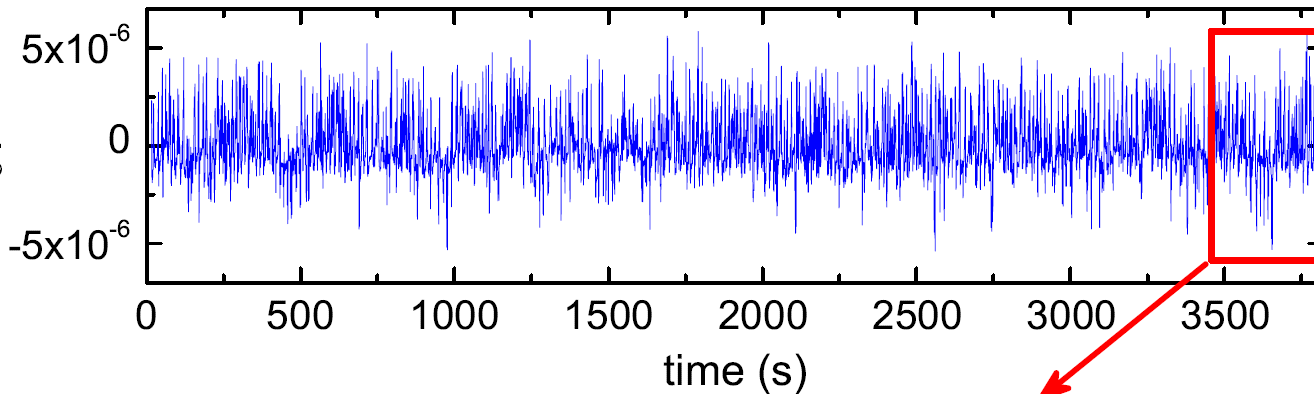
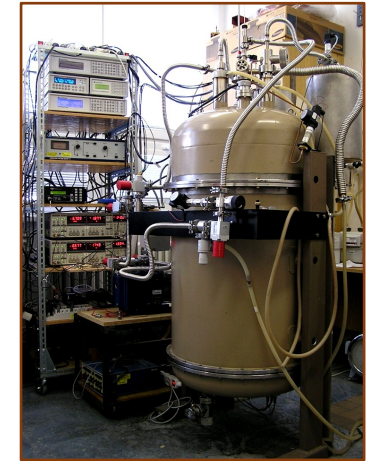
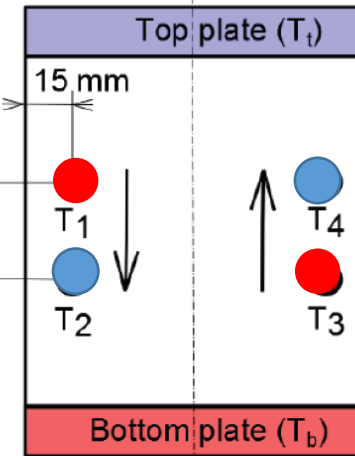

Statistical analysis (see next slide)

- Temperature fluctuations PDFs (in turbulence: non-Gaussian, heavy tails, rare events)
- Power spectra (in turbulence: broad due to “Richardson cascade” transferring energy over wide range of scales)
- Auto- and Cross-correlations (Fourier transform of spectra)
- Reynolds numbers (different types)

Temperature fluctuations in the turbulent bulk

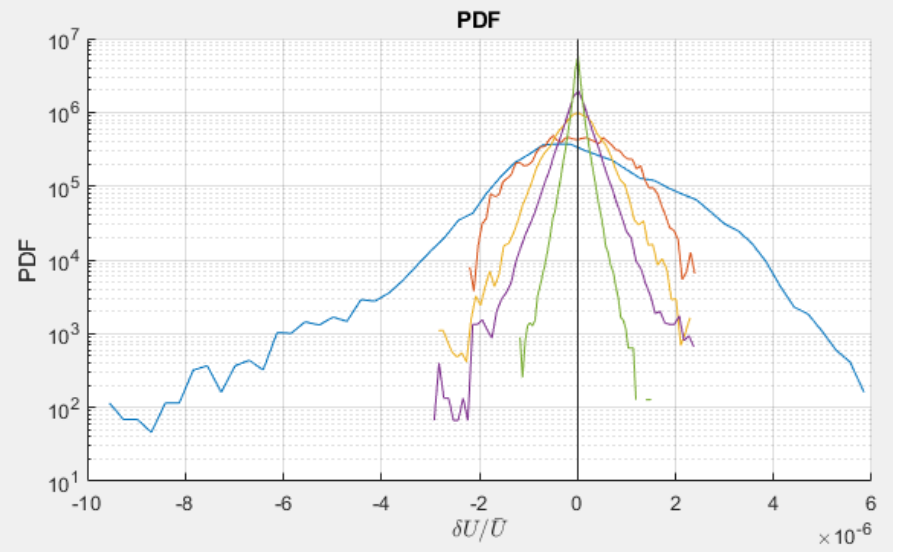
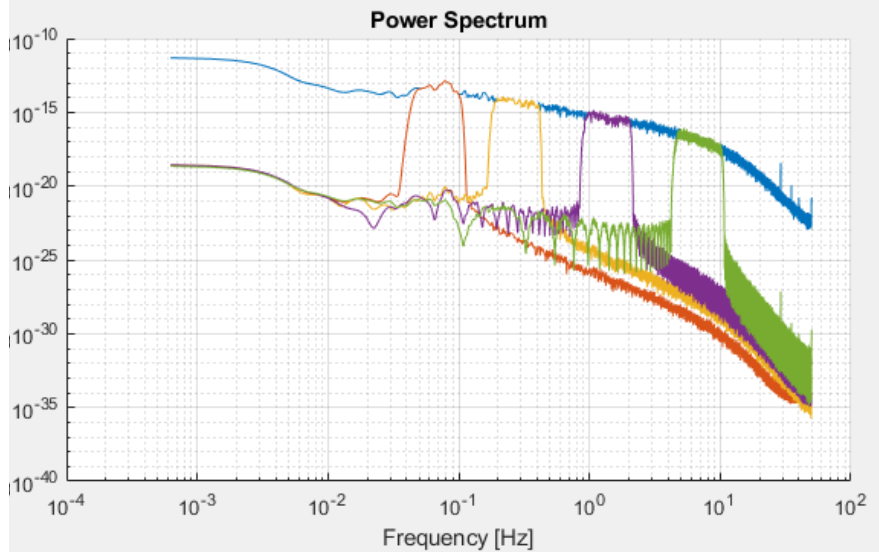
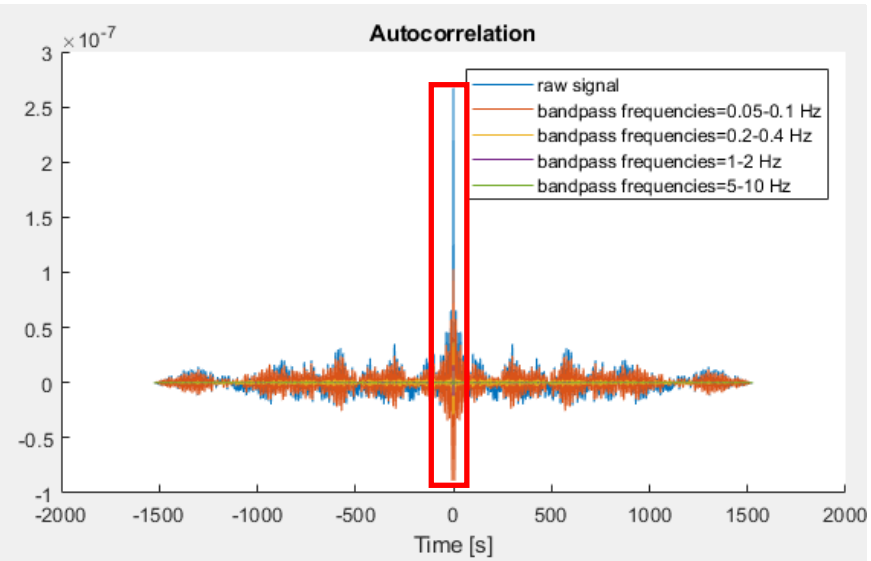
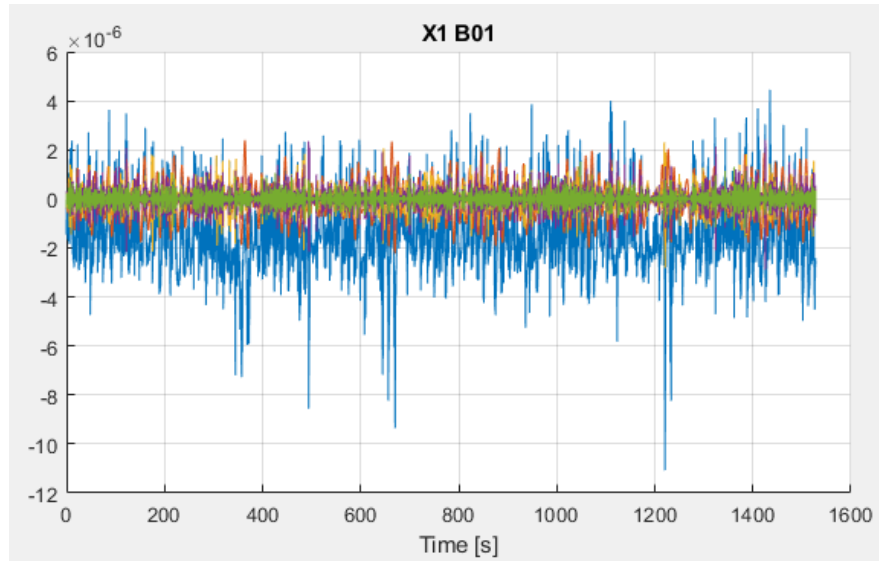

- 3 - PDF correlation functions transform**
- PDF of $\delta U/U$
 - Mean of $\delta U/U$
 - (std) phase of $\delta U/U$
 - Energy PDF
 - Zeroing

Reynolds numbers (one-point measurements)

One-point measurements:

- Frequency Reynolds number

$$Re_{f_0} = 2 \frac{L^2 f_0}{\nu}$$

Brno data fitted by a two-fold power law

$$Re = \boxed{Ra^\zeta} Pr^{-2/3}$$

where



above / below the transition point

$$Ra = Ra_c$$

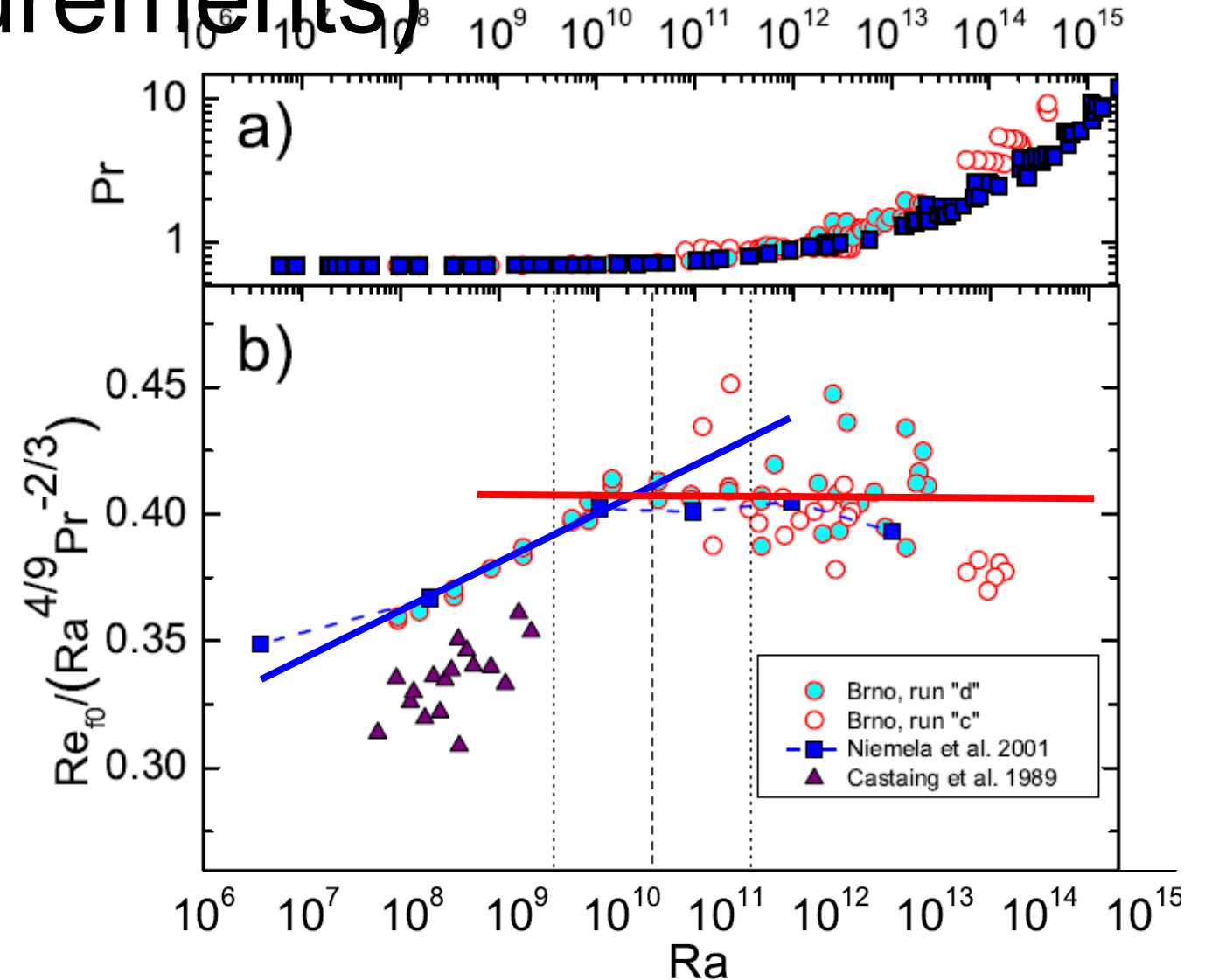

V. Musilová, T. Králík, M. La Mantia, MM., P. Urban, L. Skrbek.

J. Fluid. Mech. 832, 721 – 744 (2017).

Reynolds numbers (two-point measurements)

Two-point measurements:

- “Elliptic approximation Reynolds numbers”

G.W. He & J.B.Zhang Phys.Rev. E 73 055303 (2006)

$$Re_U = \frac{LU}{\nu} ; U = d \frac{\tau_P}{\tau_0^2} = U_P \left(\frac{\tau_P}{\tau_0} \right)^2 ;$$

$$Re_V = \frac{LV}{\nu} ; V = \frac{d}{\tau_0} \sqrt{1 - \left(\frac{\tau_P}{\tau_0} \right)^2} ;$$

$$Re_{eff} = \frac{LU_{eff}}{\nu} ; U_{eff} = \sqrt{U^2 + V^2} = \frac{d}{\tau_0}$$

- Brno data compared with SF₆ data by
X. He et al. New J. Phys 17 063028 (2015)

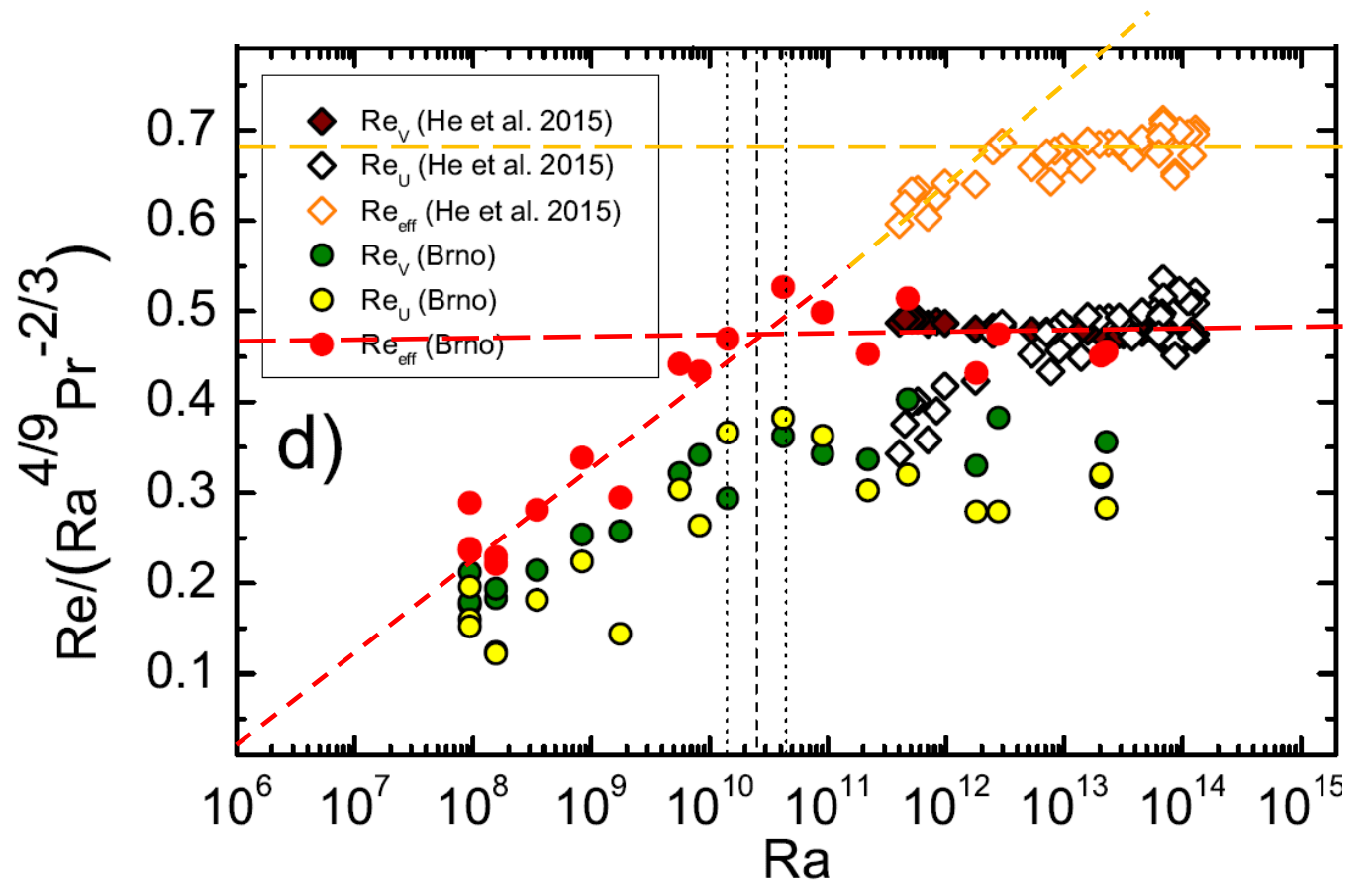

*V. Musilová, T. Králík, M. La Mantia, MM., P. Urban, L. Skrbek.
J. Fluid. Mech. 832, 721 – 744 (2017).*

change

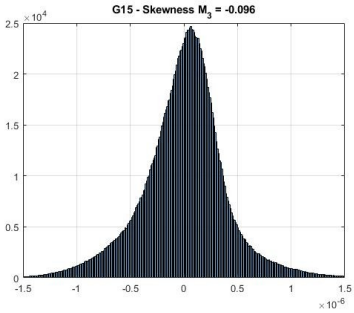

“leading sensors”

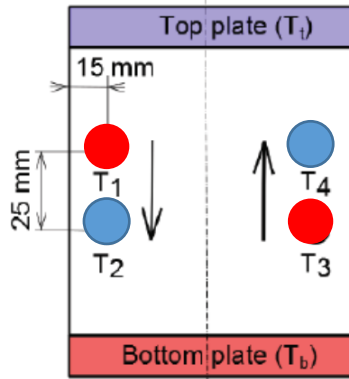

“trailing sensors”

M_3 (Skewness)

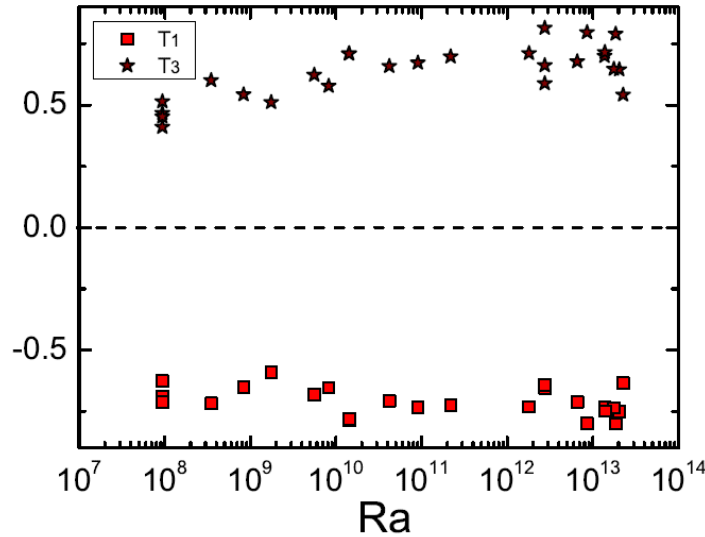

M_3 (Skewness)

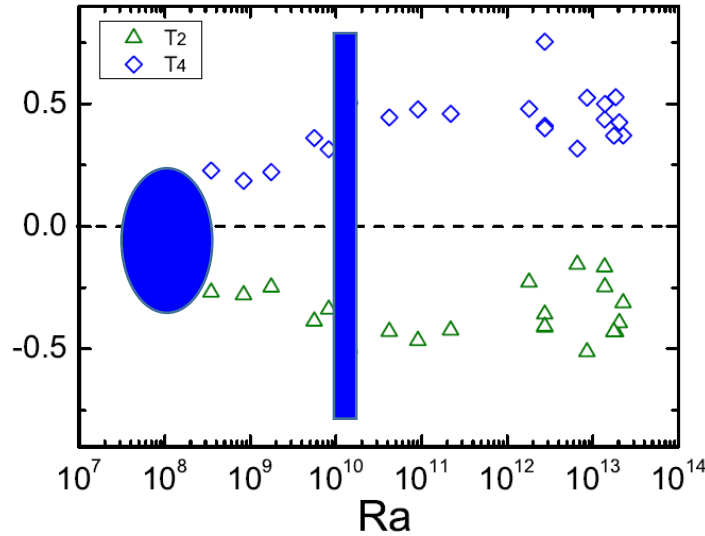

Trailing sensors outside main LSC roll for :
Tilted elliptical LSC

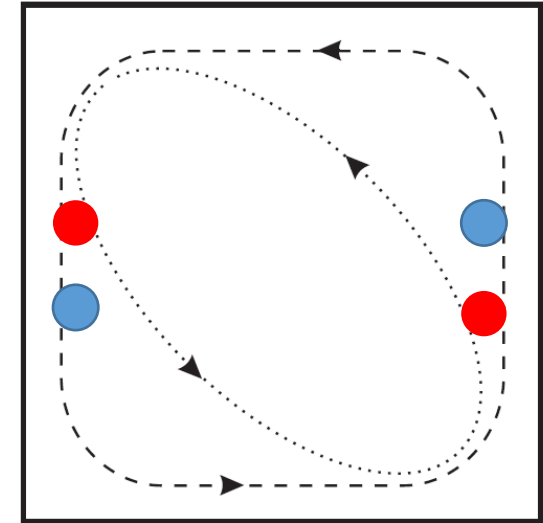

All sensors inside the main LSC roll for :
Squarish LSC shape

See also Niemela, Sreenivasan
Europhys. Lett. (2003) 62, 859

V. Musilová, T. Králík, M. La Mantia, MM., P. Urban, L. Skrbek.
J. Fluid. Mech. 832, 721 – 744 (2017).

Wind reversals

Bulk temperature fluctuations – measurement #f078:
 $Ra = 8.86 \cdot 10^{12}$, $Pr = 1.34$, $\langle Nu \rangle = 1280$

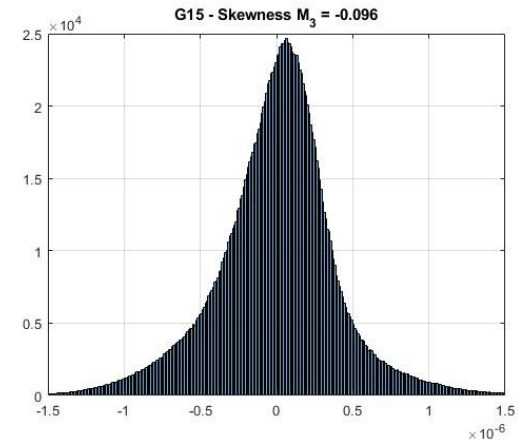
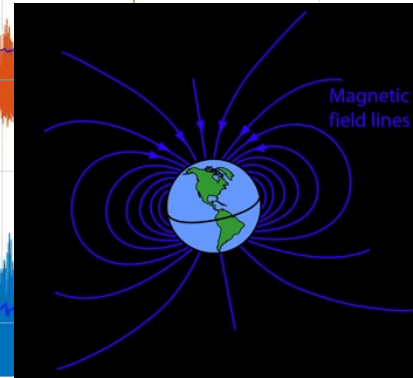
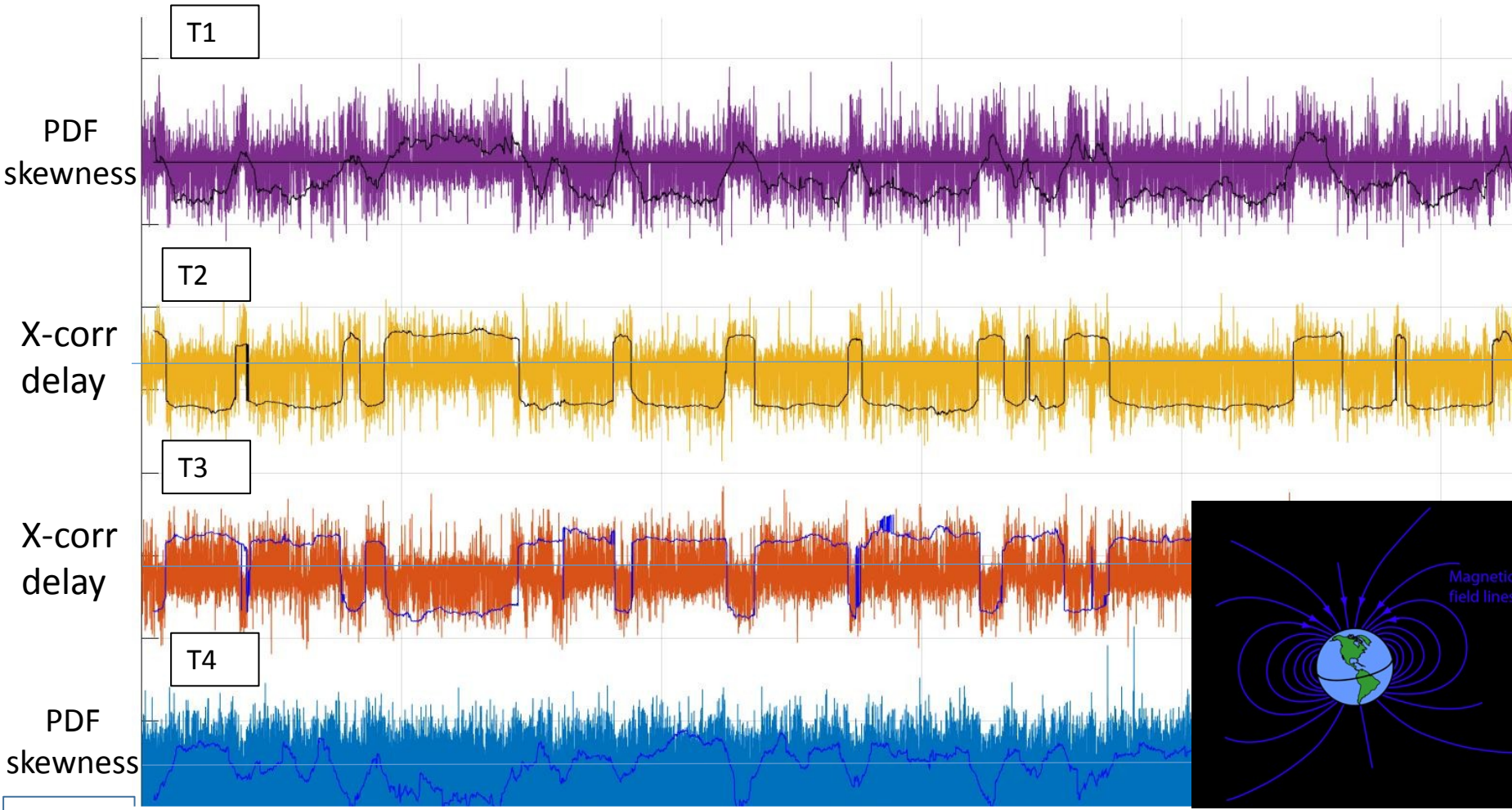
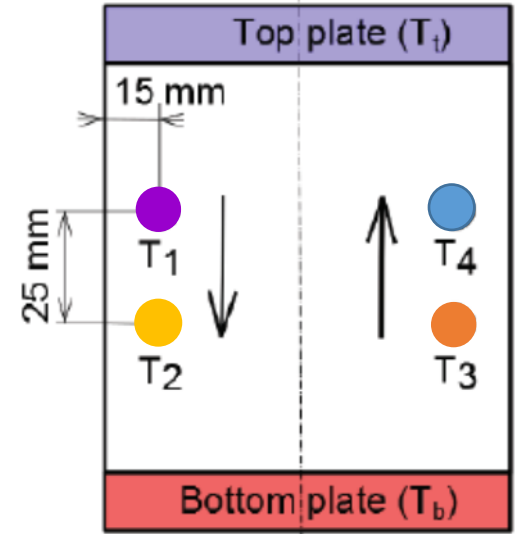

sliding
wind
analy

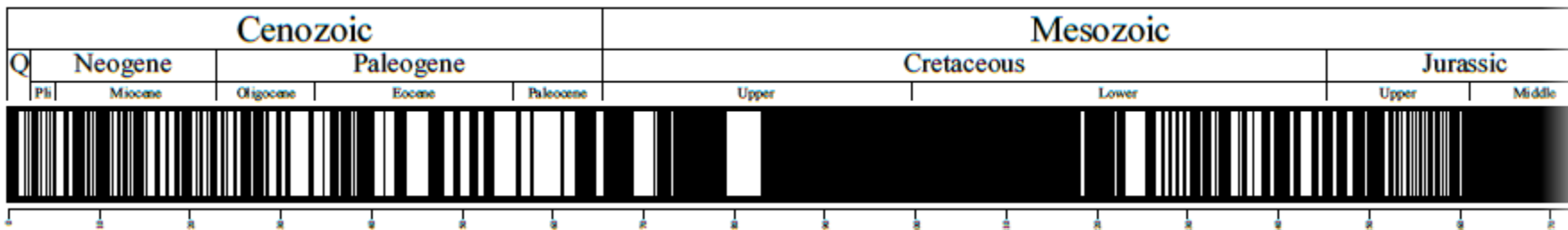

Outlook 1: Attractors in RBC and Data-based Mathematical models

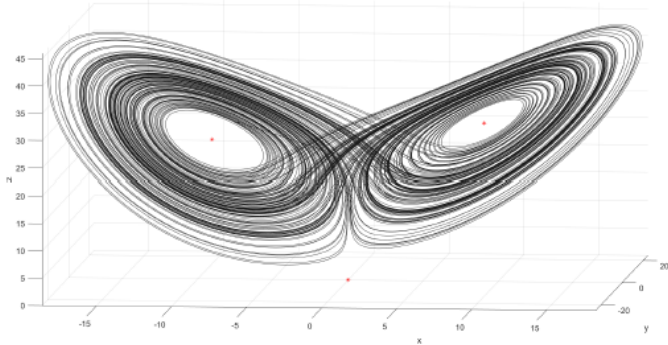

Obrázek: Původní atraktor.

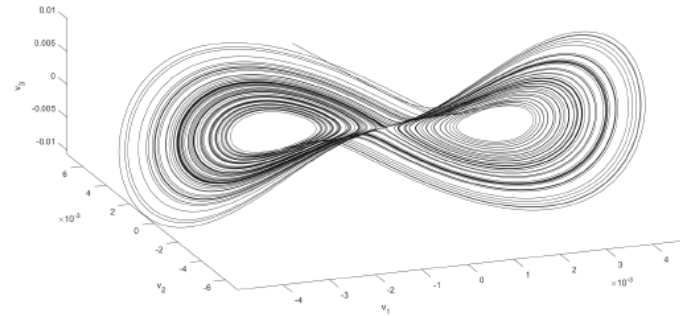

Obrázek: Vnořený atraktor.



Jakub Kašný, FSI VUT
BP 2022,
to be submitted

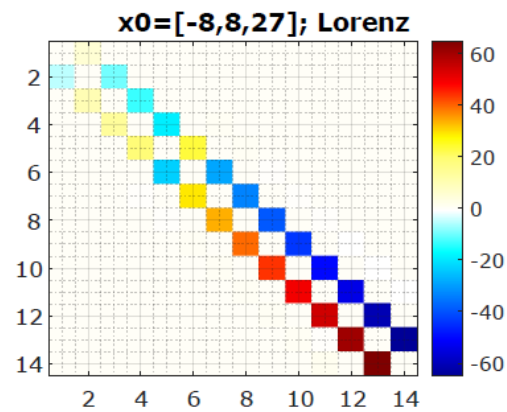

Obrázek: Barevně zobrazená matice soustavy.

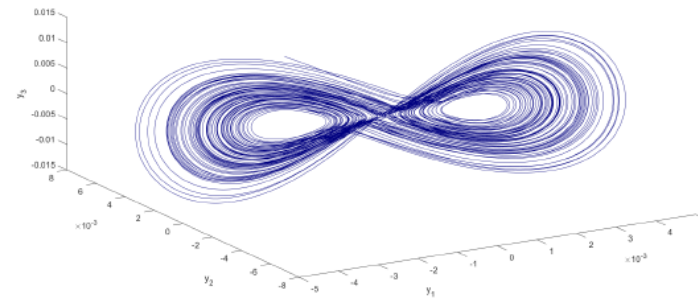

Obrázek: Rekonstruovaný atraktor.

Chaos as an intermittently forced linear system

Steven L. Brunton¹, Bingni W. Brunton², Joshua L. Proctor³, Erika Kaiser¹ & J. Nathan Kutz⁴

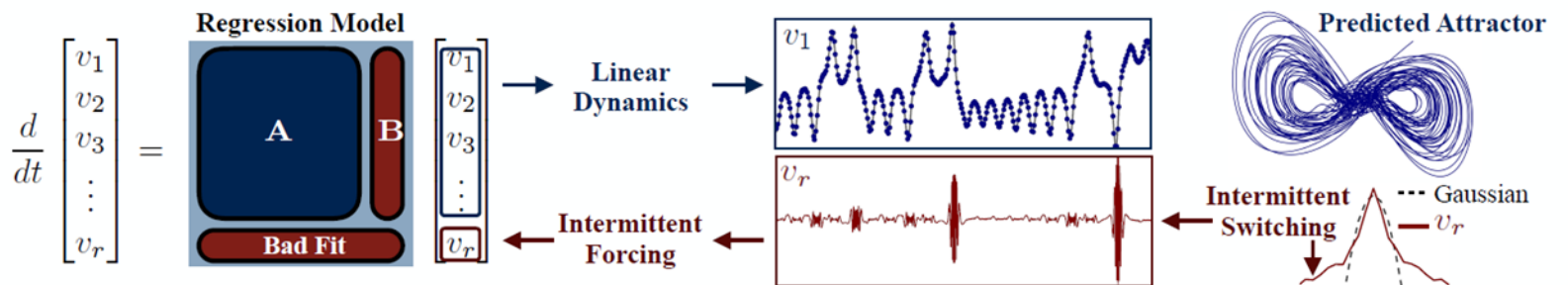
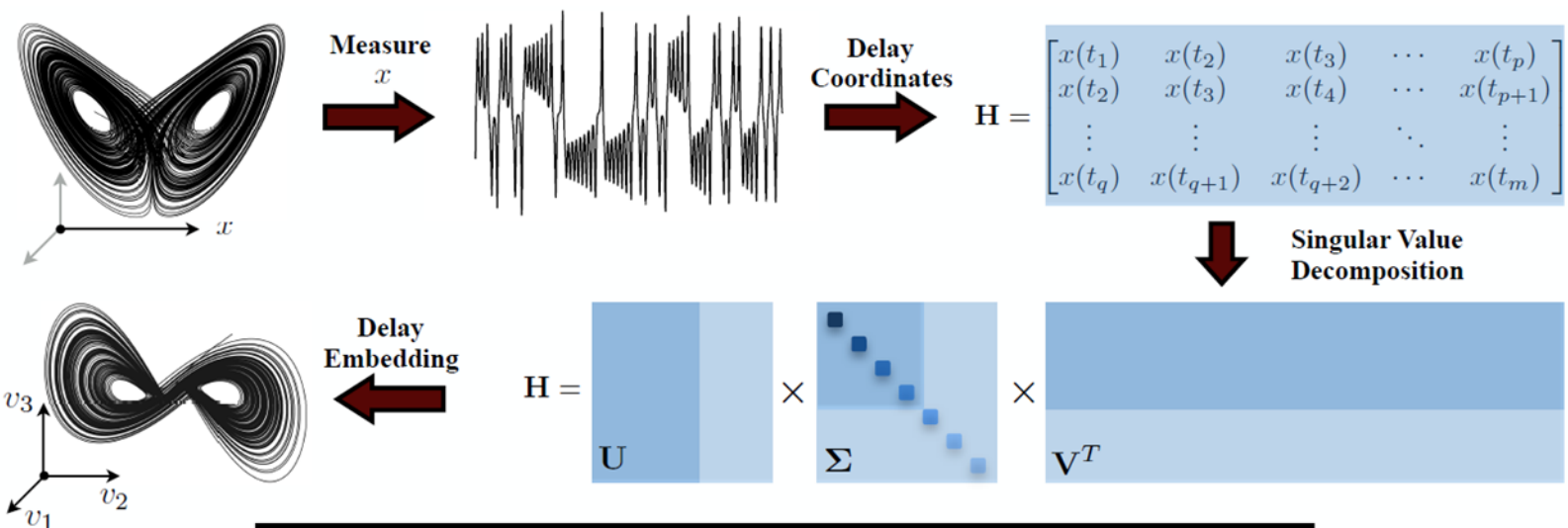
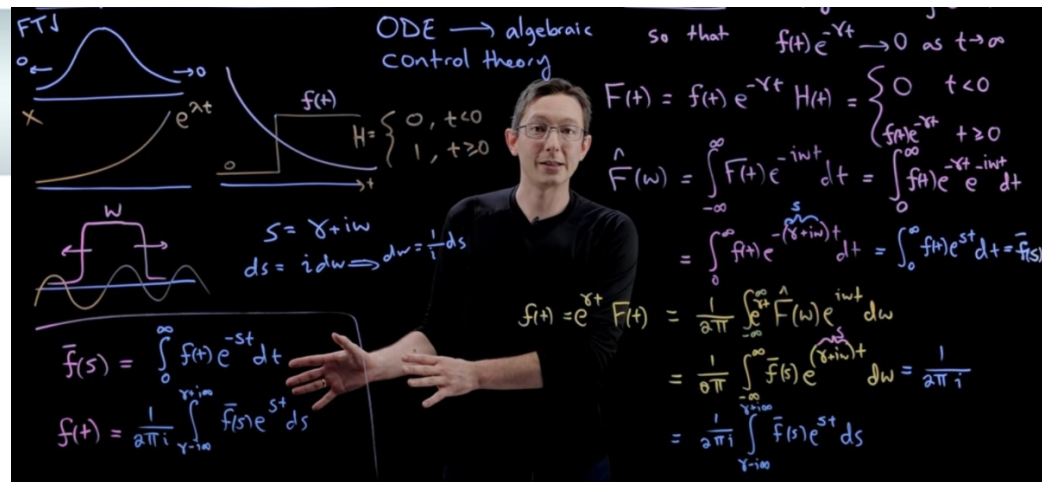

Outlook 1: Attractors in RBC and Data-based Mathematical models

HAVOK na Lorenzově systému - predikce

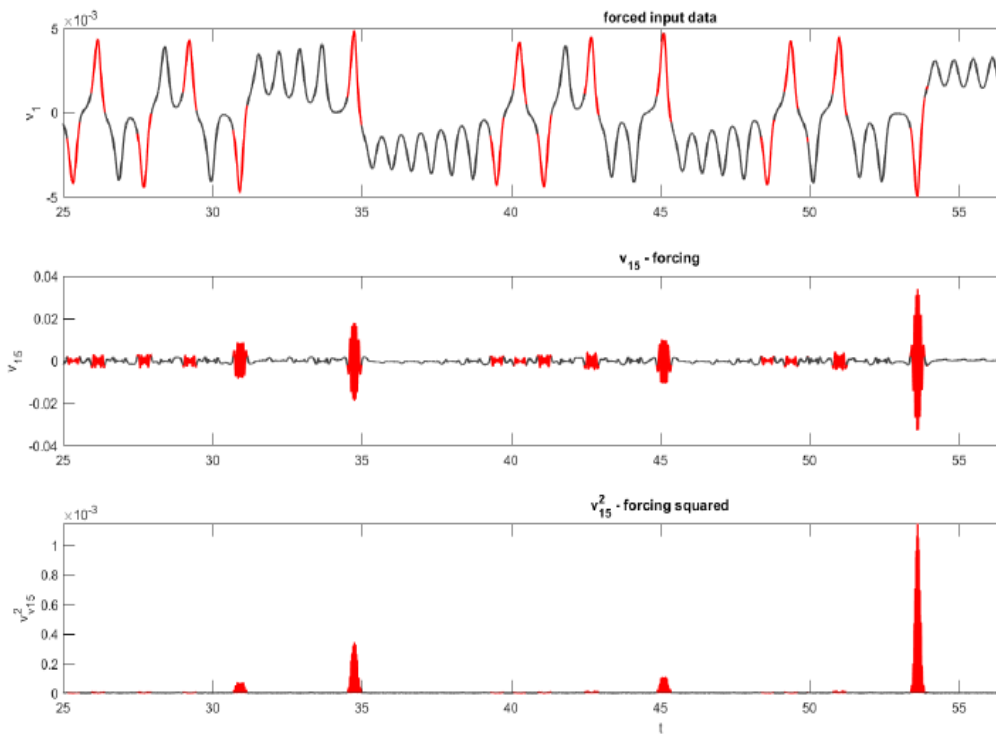

Obrázek: HAVOK predikce.

HAVOK na RBC

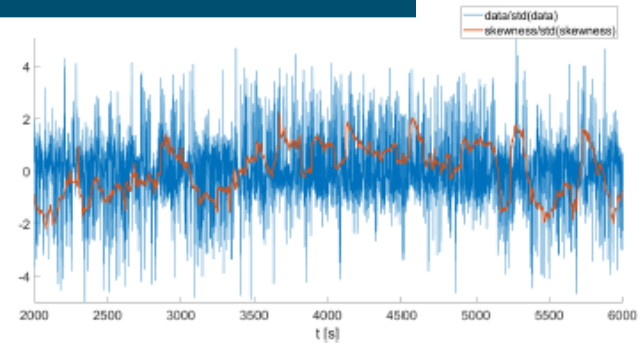

Obrázek: Signál šikmosti.

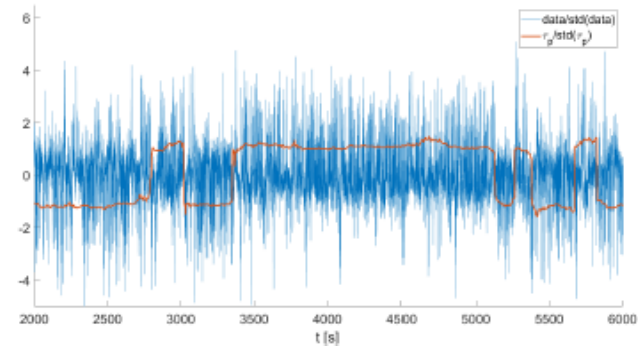

Obrázek: Signál τ_p



Jakub Kašný, FSI VUT
BP 2022,
to be submitted

Outlook 1: Attractors in RBC and Data-based Mathematical models

- Matice soustav a jejich stabilita.
- Atraktory.
- Atrakce řešení při změně počátečních podmínek.

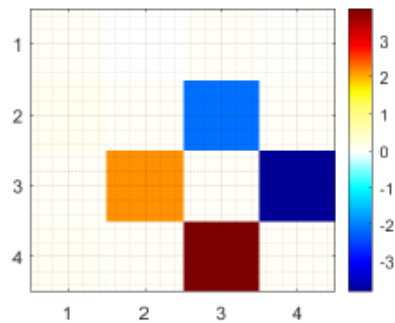

Obrázek: Matice soustavy (τ_p signál).

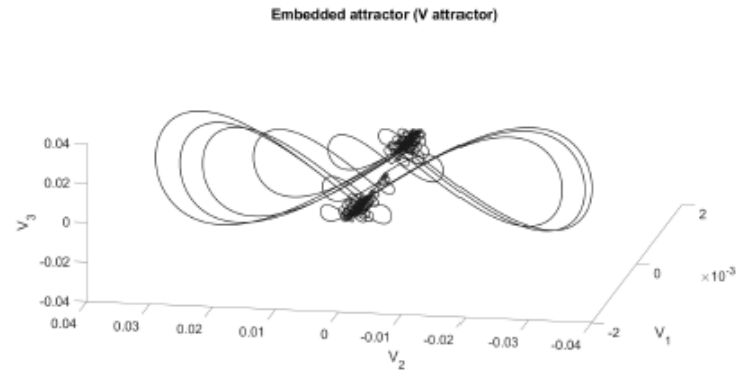

Obrázek: Vnořený atraktor (τ_p signál).

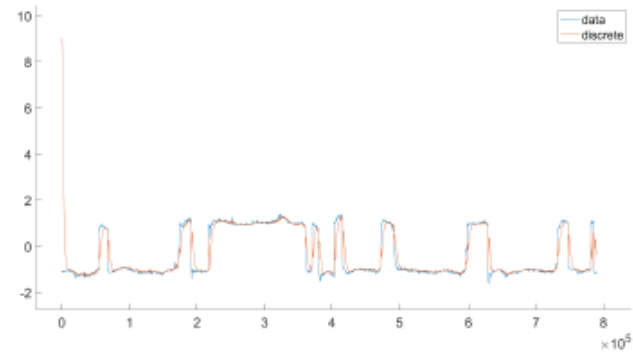

Obrázek: Jiné počáteční podmínky (τ_p signál).



Jakub Kašný, FSI VUT
BP 2022,
to be submitted

Outlook 2: Temperature modulation and rotation in Classical RBC and Quantum Counterflow



Journals ▾

Physics Magazine

Help/Feedback

PHYSICAL REVIEW LETTERS

Highlights Recent Accepted Collections Authors

Featured in Physics

Editors' Suggestion

Thermal Waves and Heat Transfer Efficiency Modulated Harmonically

P. Urban, P. Hanzelka
Phys. Rev. Lett. **128**,

Physics See Focus s

Article

Reference



AB

We s
4 × 1
cylind

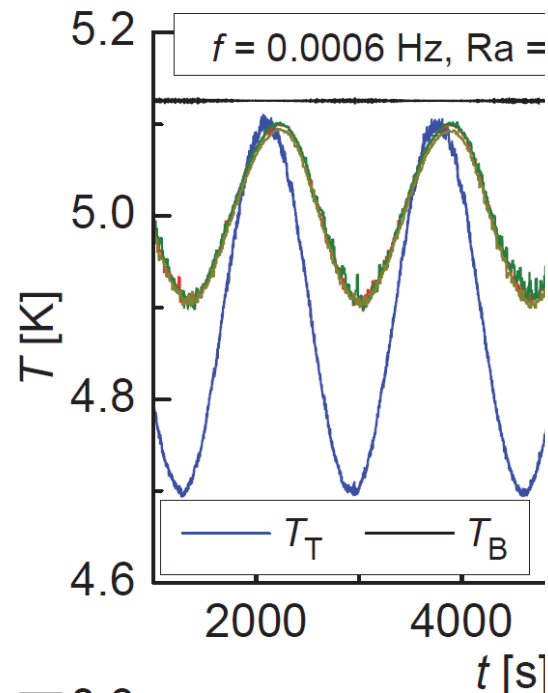

FOCUS

Temperature Oscillation Increases Heat Flow

April 1, 2022 • Physics 15, 49

If the temperature gradient in a fluid oscillates, heat flows through it more effectively, according to experiments that may have relevance for climate models.

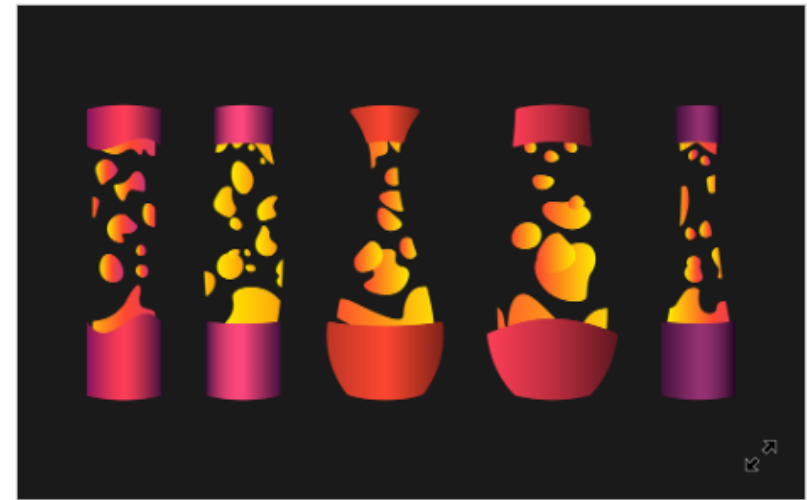

Anna P./stock.adobe.com

Thermal physics is groovy. A lava lamp undergoes Rayleigh-Bénard convection. Blobs repeatedly heat at the bottom, rise, cool at the top, and then sink. Convection experiments with cryogenic helium demonstrated the thermal effects of an oscillating temperature difference between the top and bottom of a fluid-filled chamber.

Outlook 2: Rotating platforms for Classical RBC and Quantum Counterflow

Prof. Ladislav Skrbek
(Prague)

Rotating RBC experiment under preparation at ISI Brno and Charles University Prague



OUTLOOK 2:

Rotating platforms for Classical RBC and Quantum Counterflow

Rotating RBC simulation from Richard Stevens
https://stevensrjam.github.io/Website/research_rrb.html

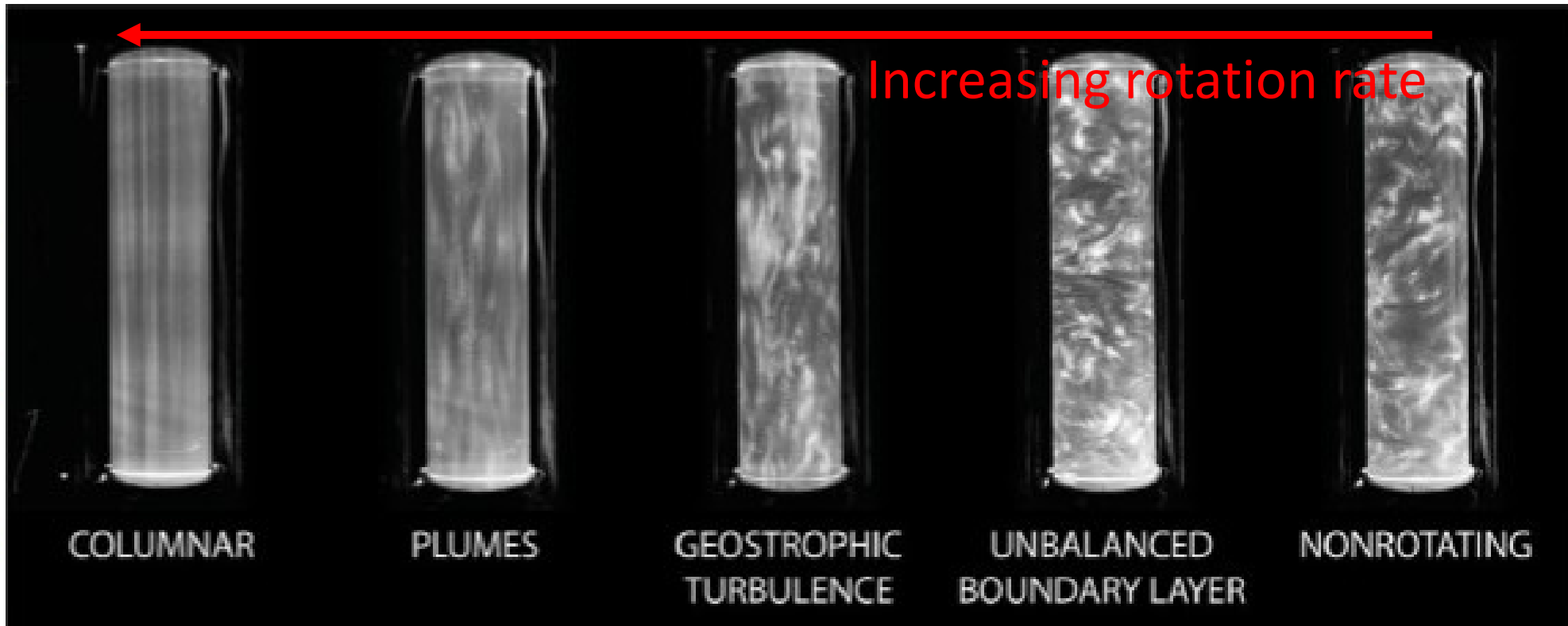
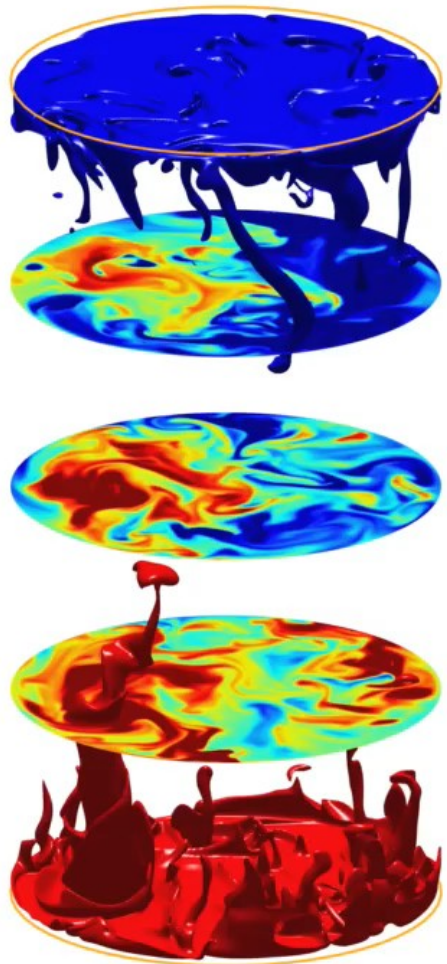
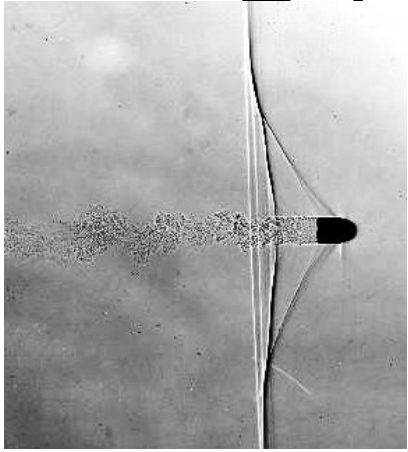

Figure 2. Schematic showing the distribution of rotating convection regimes in terms of Nusselt number (Nu) versus Rayleigh number (Ra) for a fixed Ekman number (E) and a) $Pr > 3$ and b) $Pr \lesssim 3$. Laboratory flow visualisations of each regime at $Pr \approx 7$, adapted from Cheng *et al.* (2015), are shown in the upper panel. In (a) and (b), the vertical lines indicate transition Rayleigh values: Ra_s denotes convective onset, Ra_{cp} denotes the transition between columnar-style convection and plumes, Ra_{pGT} between plumes and geostrophic turbulence, Ra_{GTU} between geostrophic turbulence and unbalanced boundary layers, and Ra_{UNR} to nonrotating-style convection. Though the transitions are delimited by lines, each likely occurs gradually over a range of Ra values. Their locations are not yet well-determined, and table 1 and figure 6 list various existing predictions. For $Pr \lesssim 3$, steady columnar convection does not occur (e.g. Julien *et al.* 2012b, Stellmach *et al.* 2014). (Colour online).

Outlook 3: Flow visualization at high Re



Ernst Mach & Peter Salcher, cca. 1890

Many visualization methods exist:

Smoke, Ink or Dye...

Particle Tracking Velocimetry,

Particle Image Velocimetry,

Laser Doppler Velocimetry

Shadograph, Schlieren, etc...

None allow to reach "ultimate" Re !

(enabling direct velocity information in RBC)

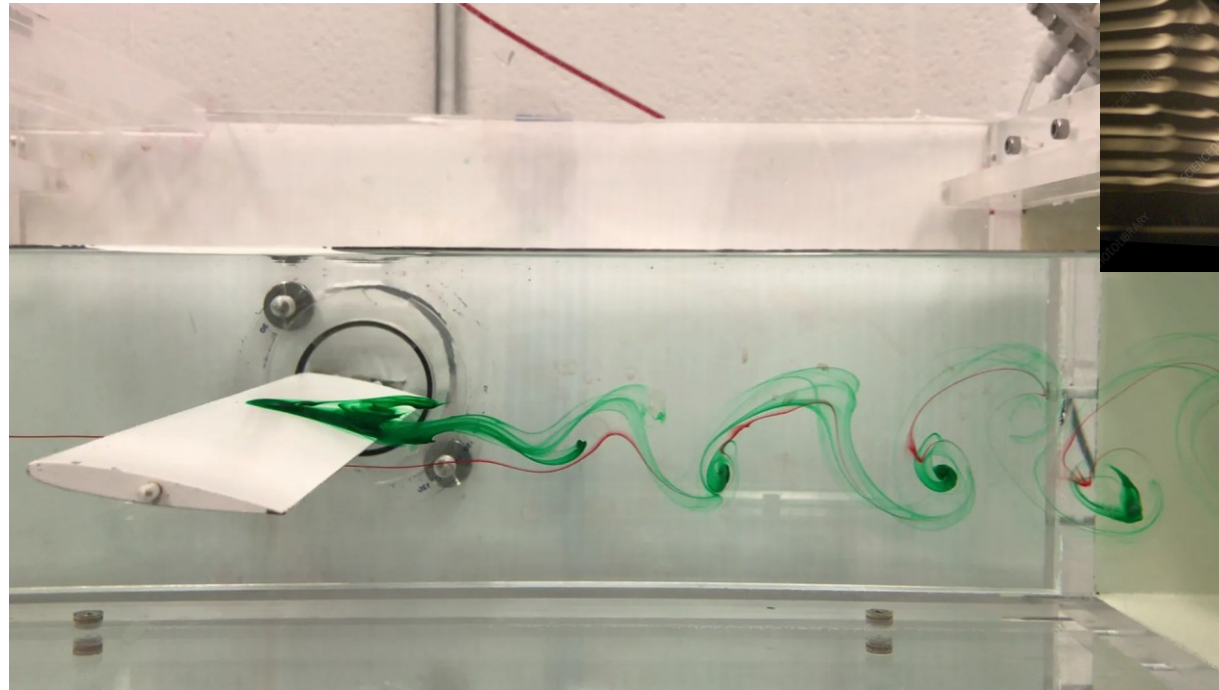
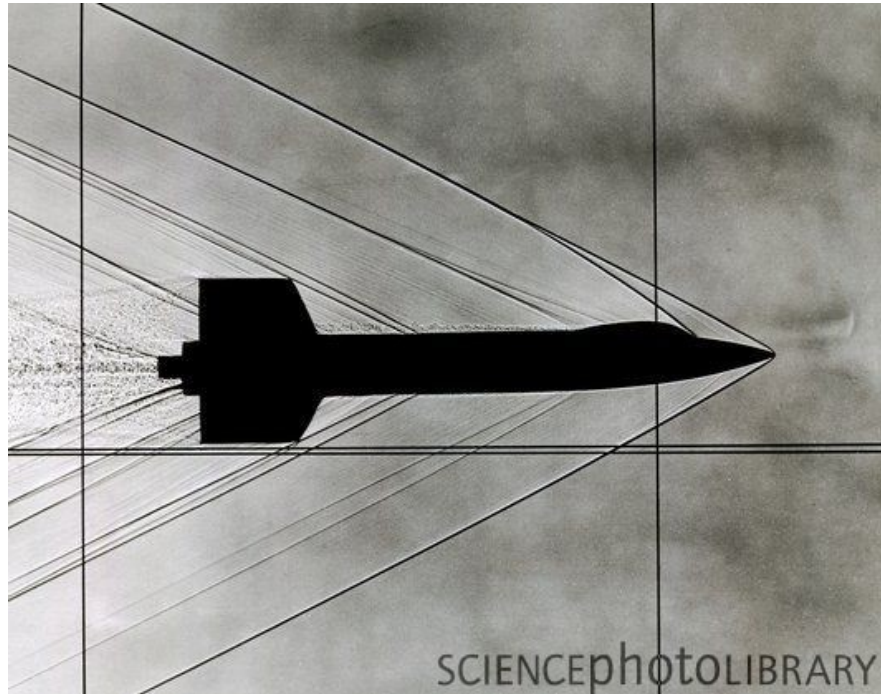
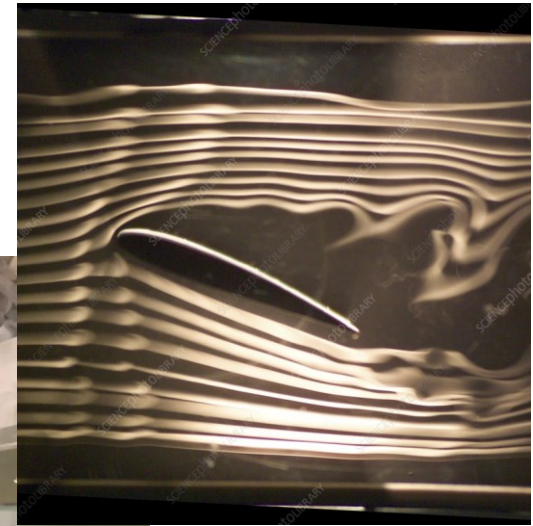

Outlook 3: Flow visualization at high Ra

A promising visualization method was developed
McKinsey et al. Phys. Rev. Lett. **95**, 111101 (2005)
W. Guo et al. Phys. Rev. Lett., **105**, 045301 (2010)

Long-living (> 10s) molecular triplet excimer He₂*
McKinsey et al. Phys. Rev. A **59**, 200 (1999)

- Excimers form after He ionization
(by fs-lasers, radioactivity, intense electric field ionization, etc...)
- Can be visualized by molecular tagging via laser-induced fluorescence (LIF)

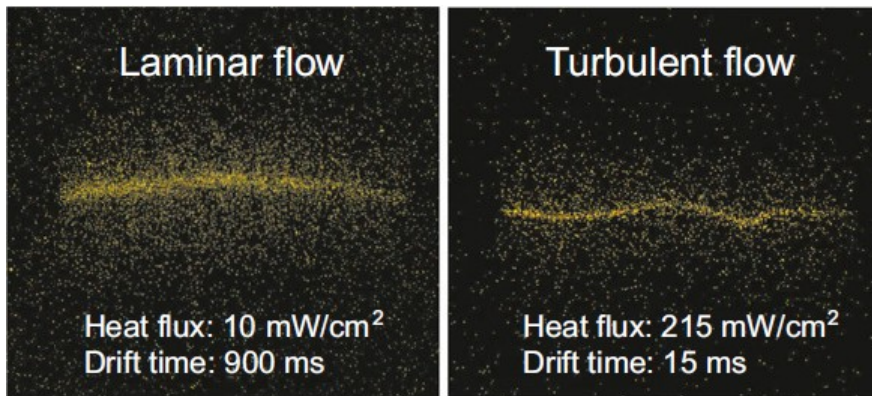

W. Guo et al. PNAS (2013)

The screenshot shows the homepage of the GUO CRYOGENICS LAB at FAMU-FSU College of Engineering. The navigation menu includes Home, Research, Publications, and Group. A large photo of Dr. Wei Guo is featured with a caption: 'Dr. Wei Guo, the principle investigator of the Cryogenics Lab.' Below the photo are five circular indicators. At the bottom, there are three panels: a sequence of He-II flow visualizations at T = 1.95 K at t = 0, 1, 2, and 5 seconds; a larger visualization of He-II flow with blue arrows indicating flow direction; and a diagram of a microstructure with a grid pattern.

R&D for turbulent flow visualization in helium gas at ISI Brno



Home Research Publications Group Facilities Resource

Laser ionization of Helium gas by the Brilliant nanosecond laser successfully accomplished

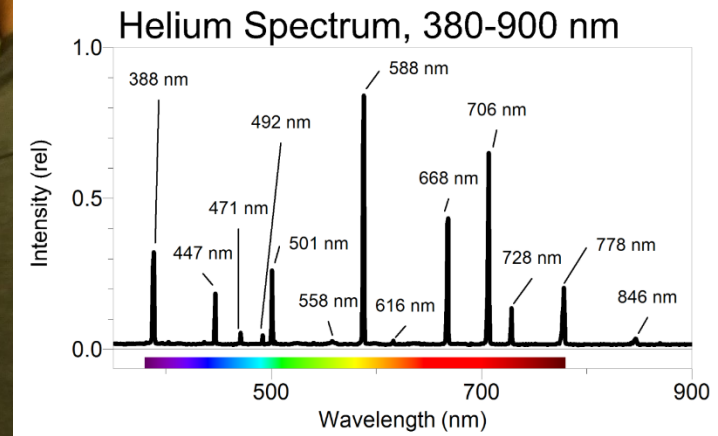
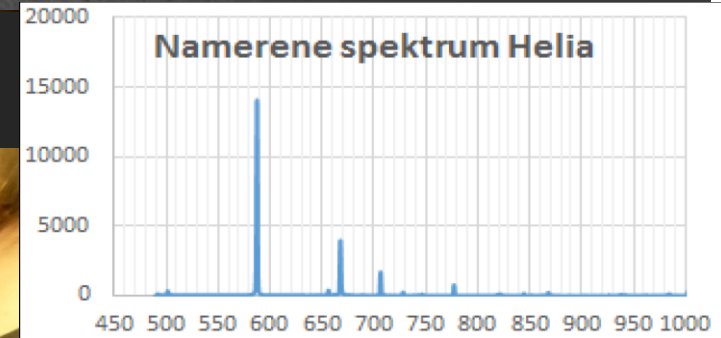
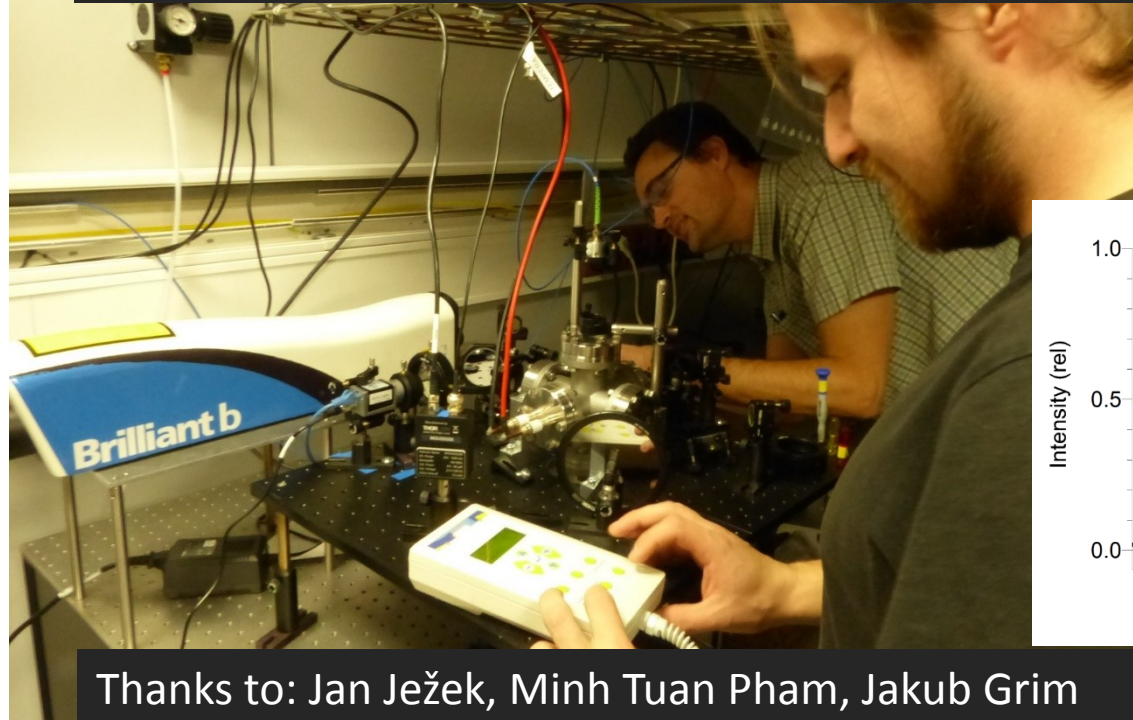

Thanks to: Jan Ježek, Minh Tuan Pham, Jakub Grim



and colleagues in Prague, Ilmenau, Florida...

Prague group of prof. Ladislav Skrbek



Summary:

- Turbulence is an open theoretical and experimental problem
- One of major open questions:
Existence of the ultimate regime, relevant e.g. at extremely large spatial scales in Nature
- Can be studied in Lab in cryogenic Helium
- Information on velocity field missing at high Ra
→ Need for high Ra visualization experiments, possibly with He_2^* excimers
- Analogous transitions laws in classical and quantum heat transfer not well understood...

Thank You!

Open BSc. and MSc. Thesis Topics:

[Experiment]

- Rotating Rayleigh-Benard Convection (with Pavel Urban)

[Theory]

- Classical-Quantum Analogy for heat transport laws in Rayleigh-Benard Convection in GHe and Counter-Flow in He-II (with Michal Macek)

[Data Analysis]

- Attractors in turbulent Rayleigh Benard Convection (with Michal Macek)
- Ultimate Regime of Convection or NOB Convection? (with Michal Macek)

Analyze and compare classical Rayleigh-Benard Convection data from:

- Cryogenic GHe experiments at ISI Brno
- Dry air experiments at Barrell of Ilmenau by group of prof. De Puits (DE)
- Highly parallel direct numerical simulations by group of prof. Schumacher (TU Ilmenau, DE)

•

Content of the lectures

1. What is turbulent convection and why do we study it at ISI CAS Brno
2. Statistics of turbulence: Stochastic models + signal analysis with practical examples in MATLAB
3. Deterministic models for turbulence – How to derive Lorenz system from Hydrodynamic equations ...
4. Data-driven models for turbulent convection