

# 4. Glow Discharge

FB242 Gas discharges: physical mechanisms and applications



**Funded by  
the European Union**  
NextGenerationEU



**CZECH  
RECOVERY  
PLAN**



MINISTRY OF EDUCATION,  
YOUTH AND SPORTS

**Glow discharge** – burns at reduced gas pressures, typically less 0.01 atm

Doutnavý  
výboj  
ve vzduchu

At certain conditions it can be stabilized also at atmospheric-pressure as the so-called Atmospheric Pressure Glow Discharge (APGD):

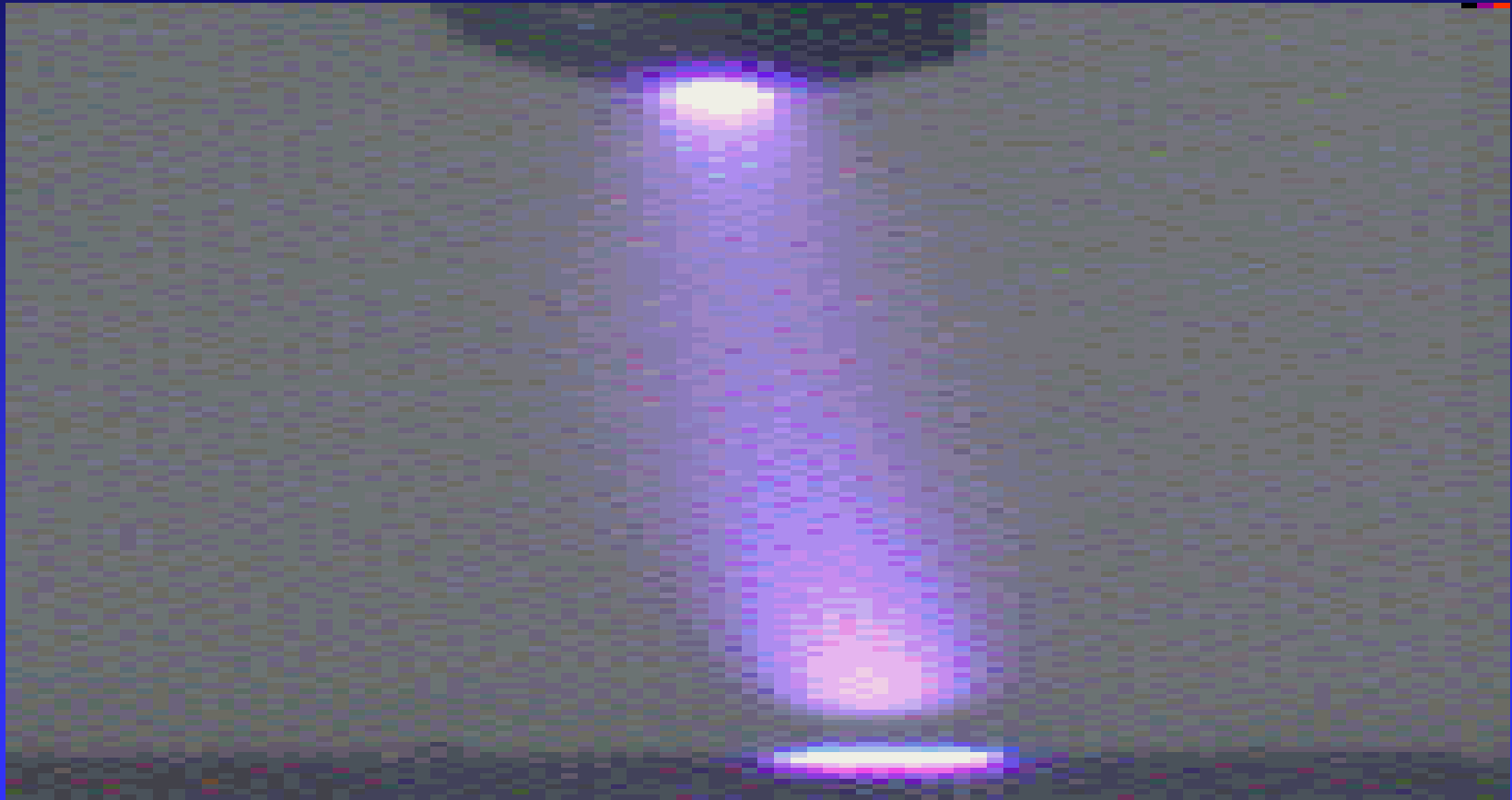

**Subnormal G.D.:** the plasma is in contact with only a small part of the cathode surface at low currents. As the current is increased from D to E, the fraction of the cathode occupied by the plasma increases, until plasma covers the entire cathode surface at point E.

**Normal G.D.:** the voltage is almost independent of the current over several orders of magnitude in the discharge current. The electrode current density ( $j/p^2 = \text{konst.}$ ) is independent of the total current in this regime.

**Abnormal G.D.:** point F, the voltage increases significantly with the increasing total current in order to force the cathode current density above its natural value and provide the desired current.

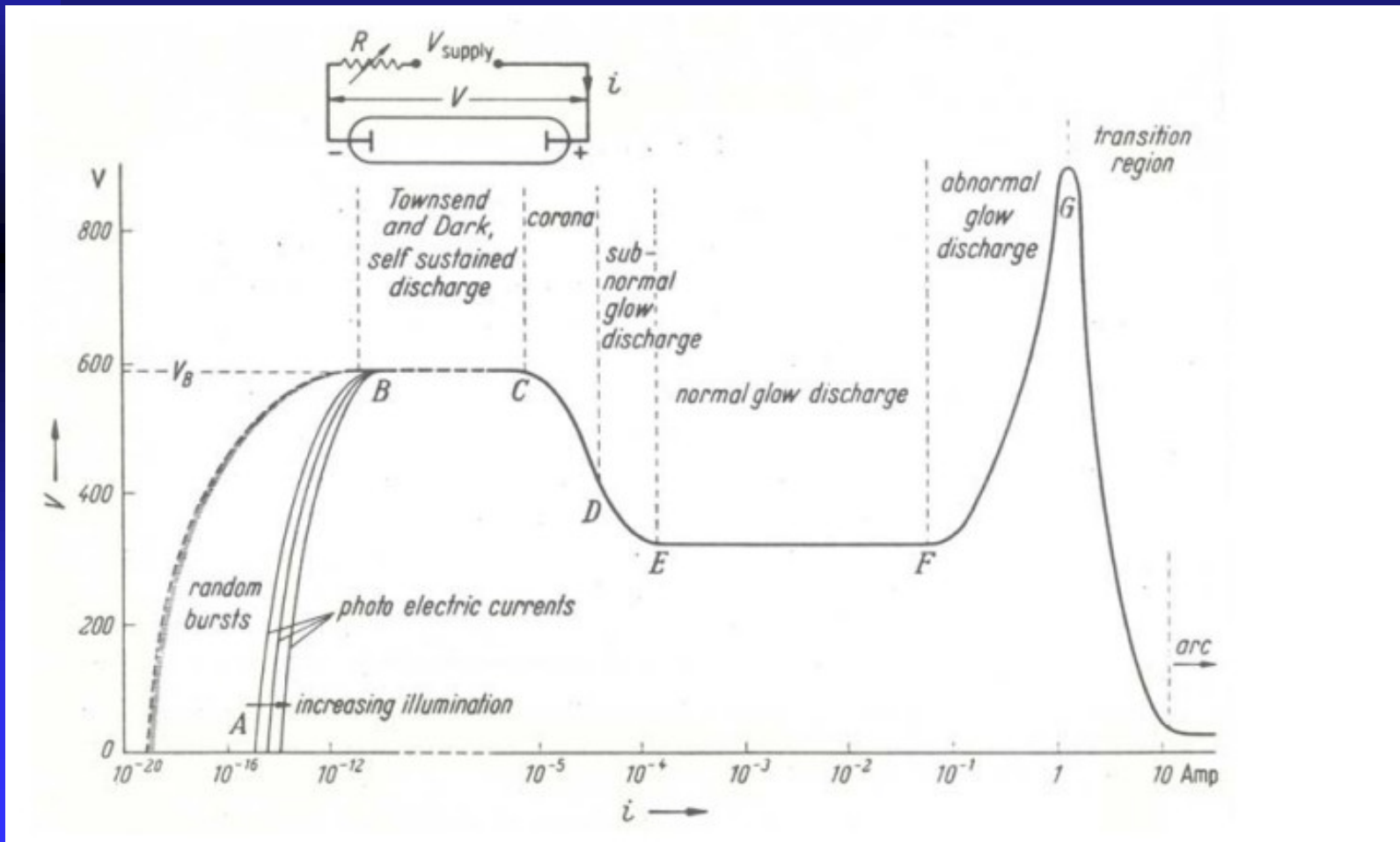

$(j/p^2) = \text{konst.}$  (Engel a Steinbeck)

(alternating 50 Hz glow discharge)

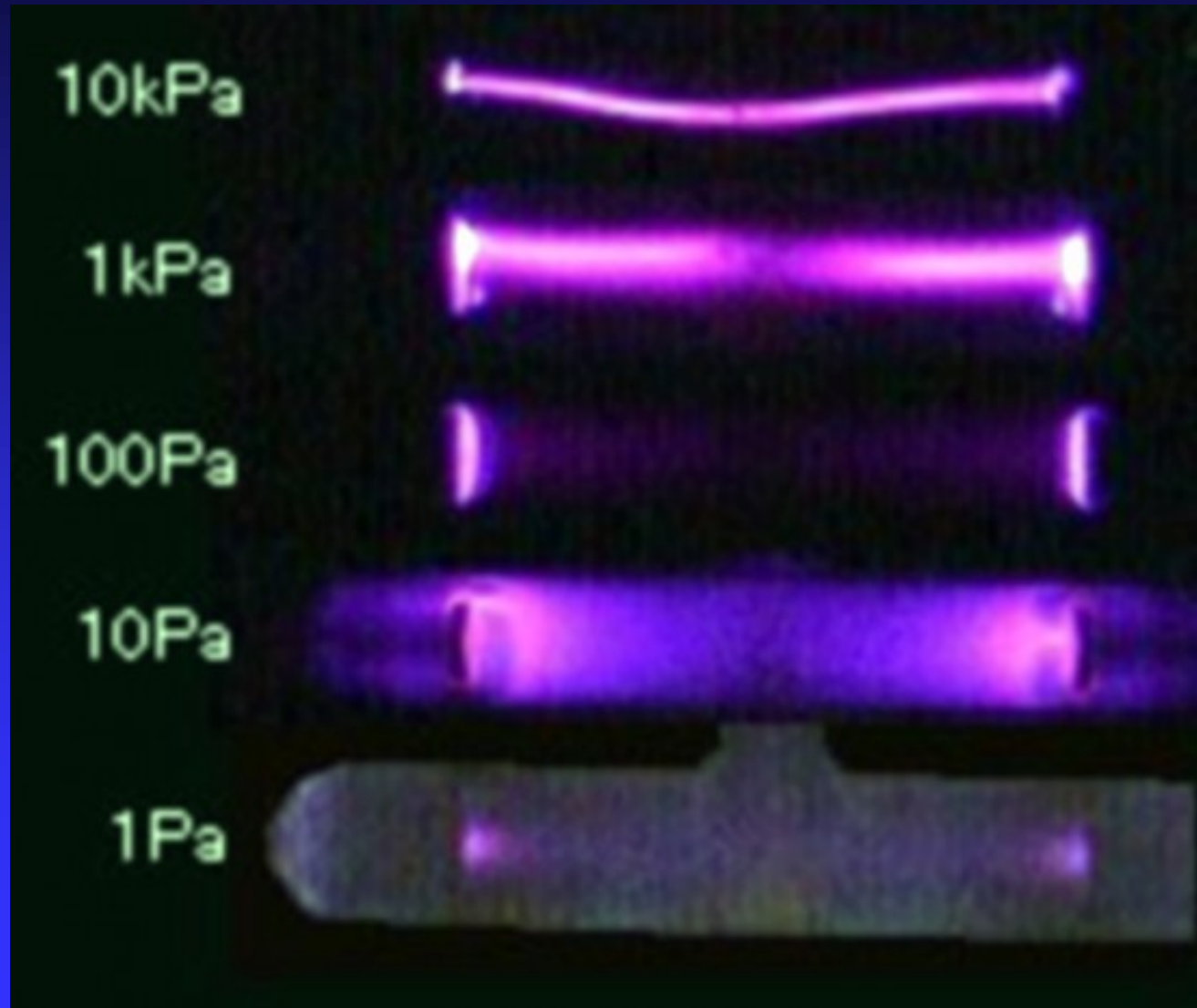

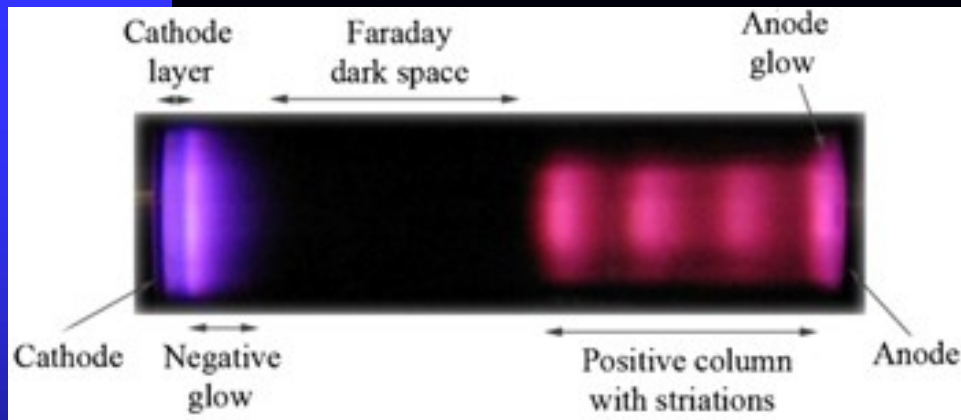

**Cathode** – with a secondary emission coefficient  $\gamma$  that is very important for the operation of the GD.

**Aston Dark Space** – A thin region to the right of the cathode with a strong electric field. The electrons are accelerated through this space away from the cathode. This region has a negative space charge, meaning that stray initial electrons together with the secondary electrons from the cathode outnumber the ions in this region. The electrons are too low density and/or energy to excite the gas, so it appears dark.

**Cathode layer (glow)** – The the electrons are energetic enough to excite the neutral atoms they collide with and their energy is increasing. The cathode glow has a relatively high ion density. The axial length of the cathode glow depends on the type of gas and the pressure. The cathode glow sometimes clings to the cathode and masks the Aston dark space.

**Cathode dark space** - has moderate electric field, a positive space charge and a relatively high ion density.

**Negative Glow** – The brightest intensity of the entire discharge. The negative glow has relatively low electric field and is the most intense on the cathode side. Electrons carry almost the entire current in the negative glow region. Electrons that have been accelerated in the cathode region to high speeds produce ionization, and slower electrons that have had inelastic collisions already produce excitations. These slower electrons are responsible for the negative glow. The electron number density in the negative glow is about  $10^{16}$  electrons/m<sup>3</sup>. As these electrons slow down, energy for excitation is no longer available and Faraday dark space begins.

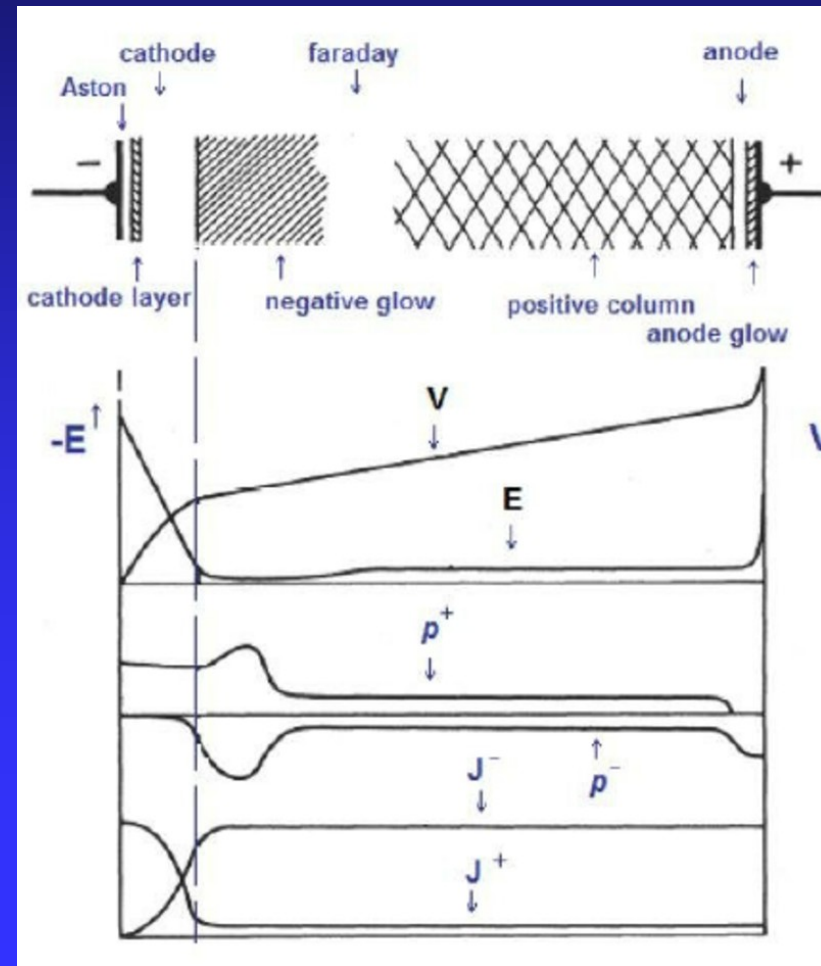

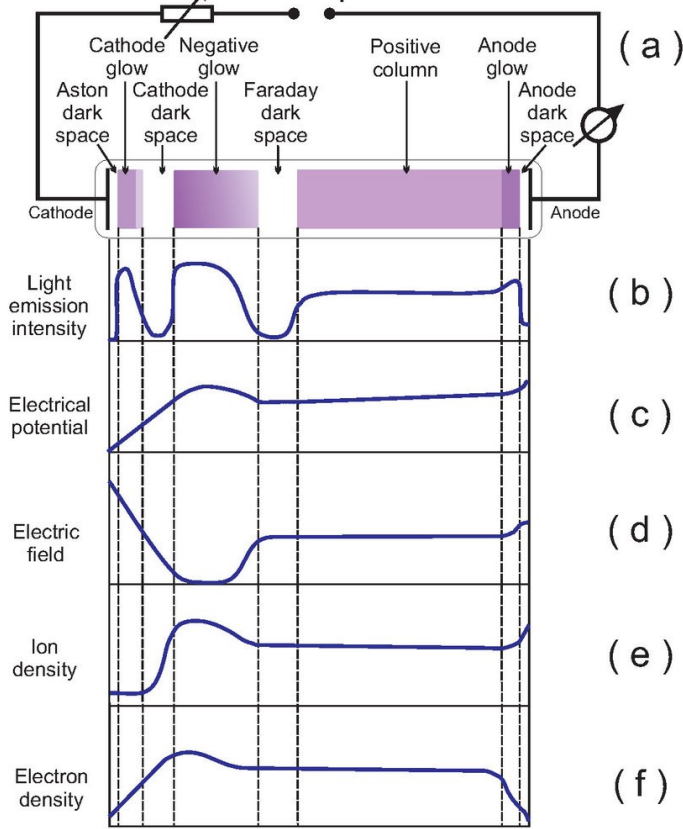

**Cathode Region.** – Most of the voltage drop across the discharge tube occurs between the cathode and the negative glow. The length of the cathode region, from the cathode surface to the boundary of the negative glow is  $d_c$ . The voltage drop here is  $V_c$  volts. Most of the power is dissipated in this region. The electrons are accelerated in this region to energies high enough to produce ionization and avalanching in the negative glow, and in the regions to the right of the negative glow. **A low pressure discharge will adjust the axial length of its cathode region,  $d_c$ , so that the minimum value of the product  $d_c p$  is established,  $d_c p \sim (d.p)_{min}$ . This product is the Paschen minimum. At the Paschen minimum the discharge maintains itself with a minimum cathode fall voltage  $V_c$  and minimum power dissipation. In the normal glow discharge, the current density flowing to the cathode remains approximately constant as the total current varies, as the total area of contact with the cathode increases with the total current.** Typical values in air at a pressure of 1 Torr might be a current density of 0.3 mA/cm<sup>2</sup>,  $d_c$  approximately 0.5 cm, and cathode fall voltage between 100 to 300 V

**Positive Column** – **Quasi-neutral plasma**, small electric field, typically 1 V/cm. The electric field is just large enough to maintain the degree of ionization at its cathode end. The electron number density is about  $10^{15}$  to  $10^{16}$  electrons/m<sup>3</sup> in the positive column, and the electron temperature of 1 to 2 eV. In air the positive column plasma is pinkish blue. As the length of the discharge tube is increased at constant pressure, the length of the cathode structures remains constant ( $p d_c = \text{constant}$ ), and the positive column lengthens. The positive column is a long, uniform glow, except when standing or moving striations are triggered spontaneously, or ionization waves are triggered by a disturbance

The cathode potential fall equals to the  $(U_z)_{\min}$ , and the cathode region width  $d_c$  corresponds to the  $(p \cdot d)_{\min}$ :

An example of the discharge similarity !!!

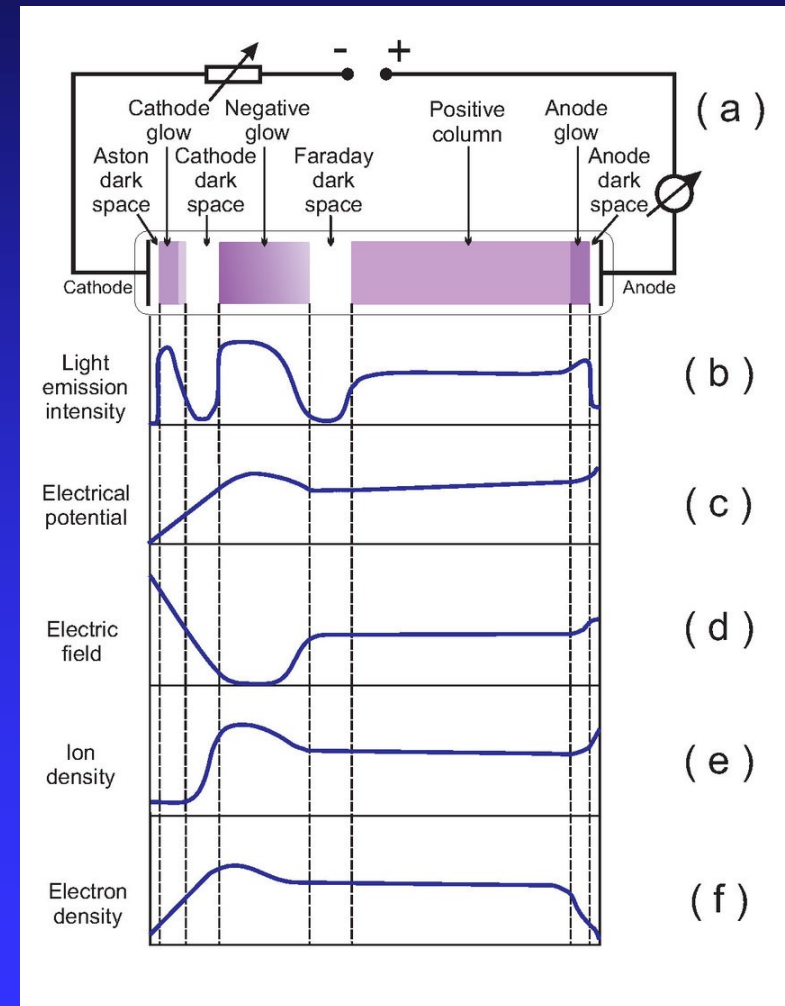
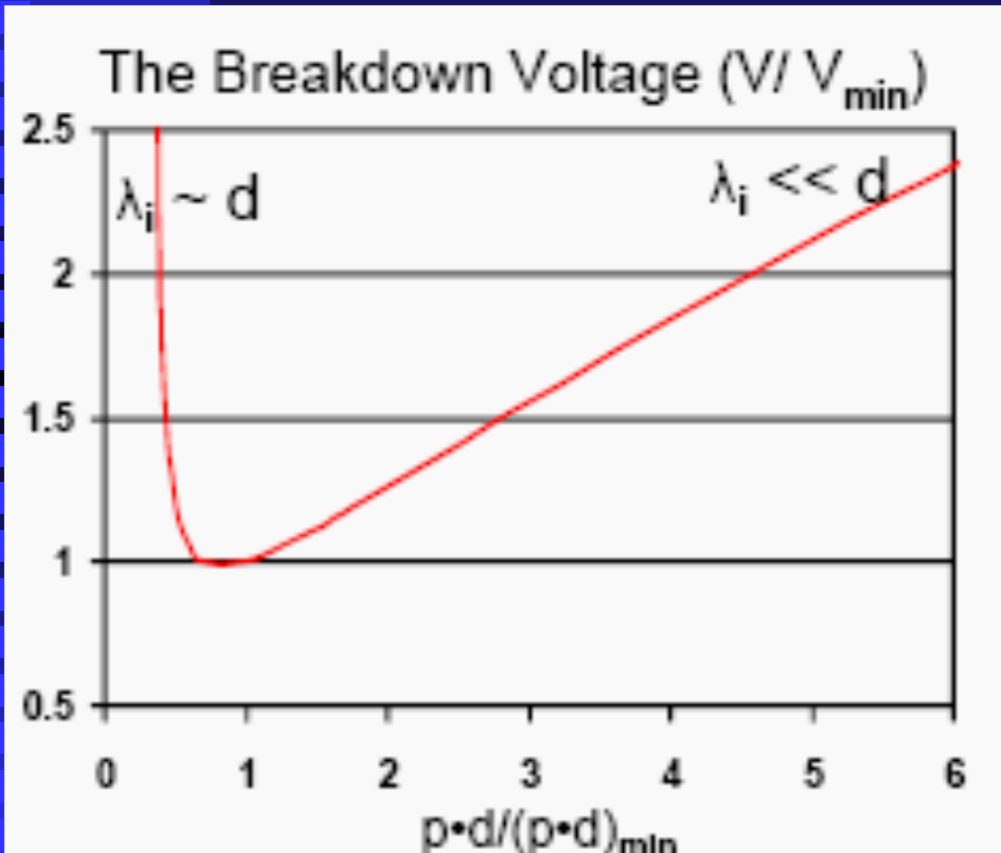



# Transition Townsend discharge – Glow discharge: Formation of the cathode region

(see A. Fridman: Plasma Chemistry, p. 178)

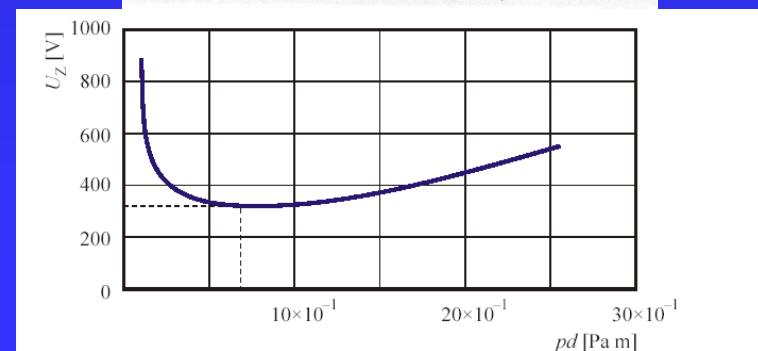
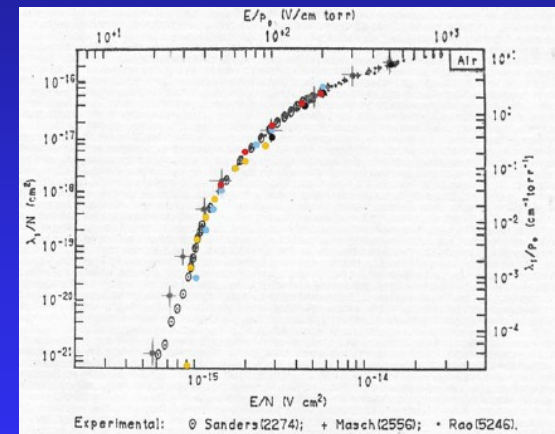
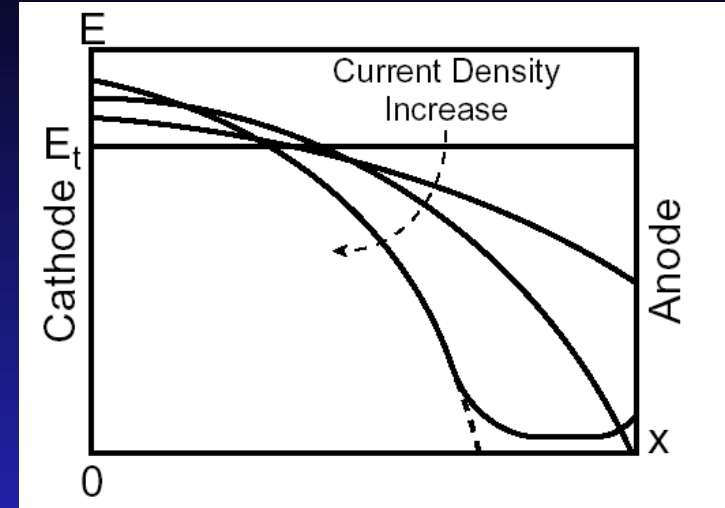
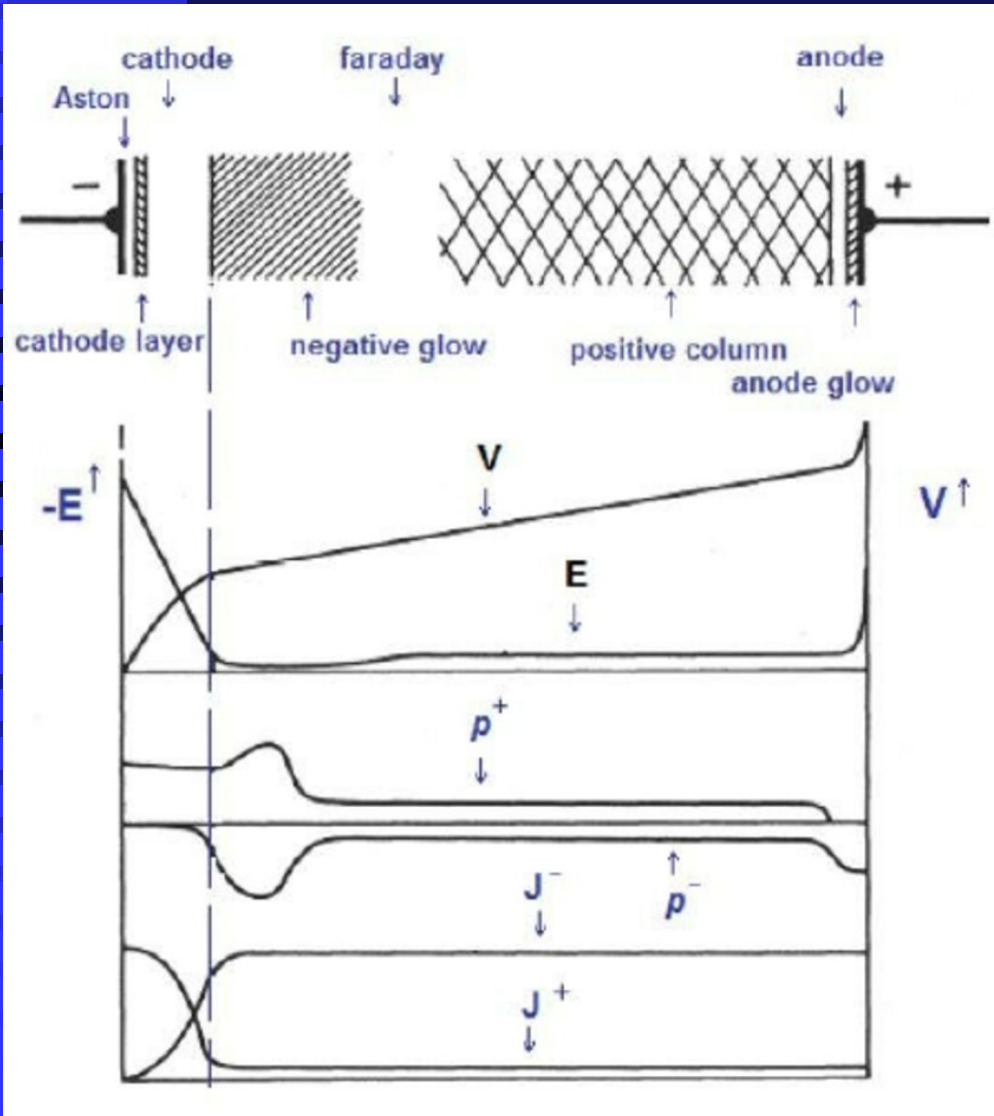

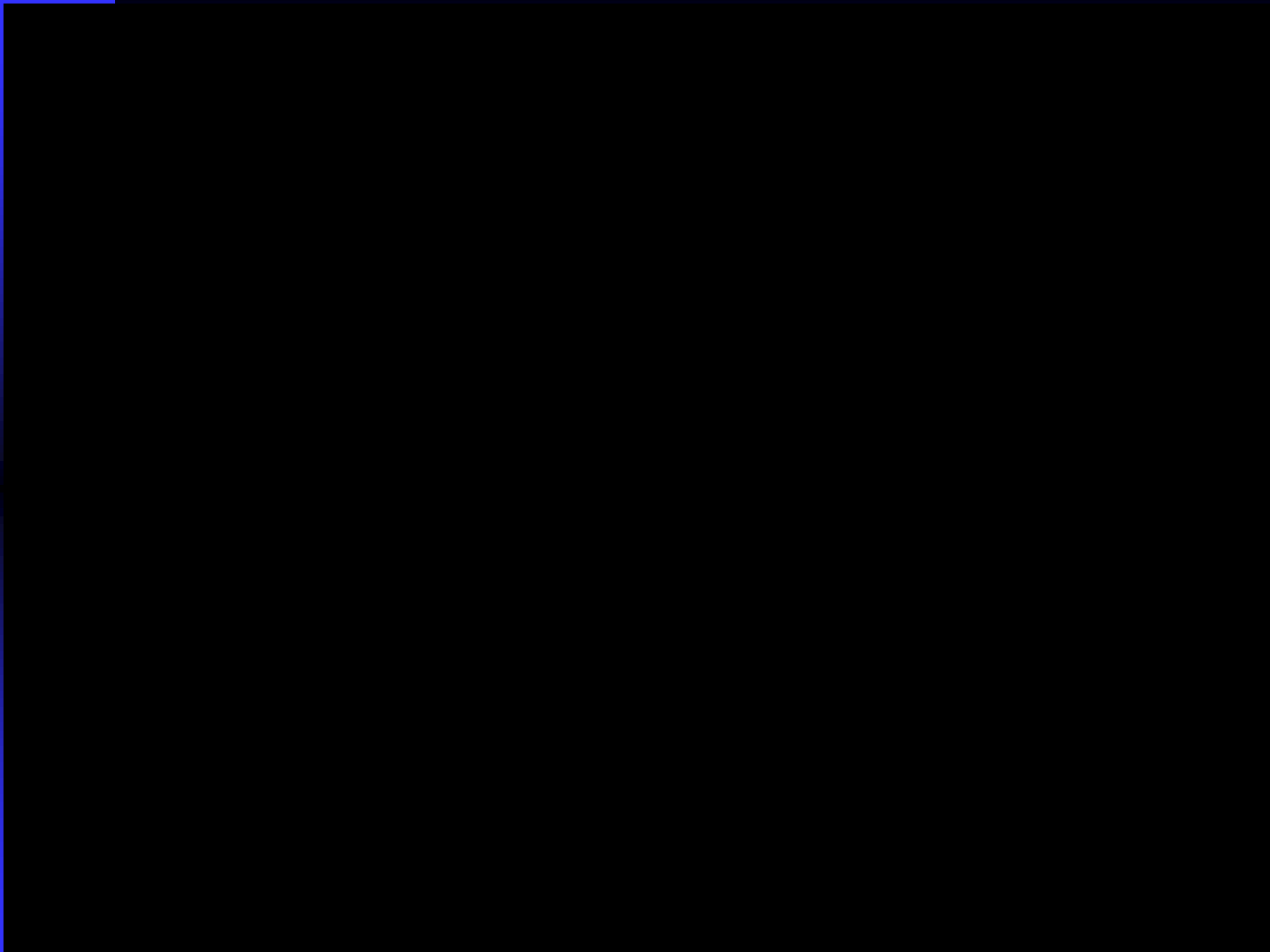

The positive column is  
a highly non-equilibrium plasma

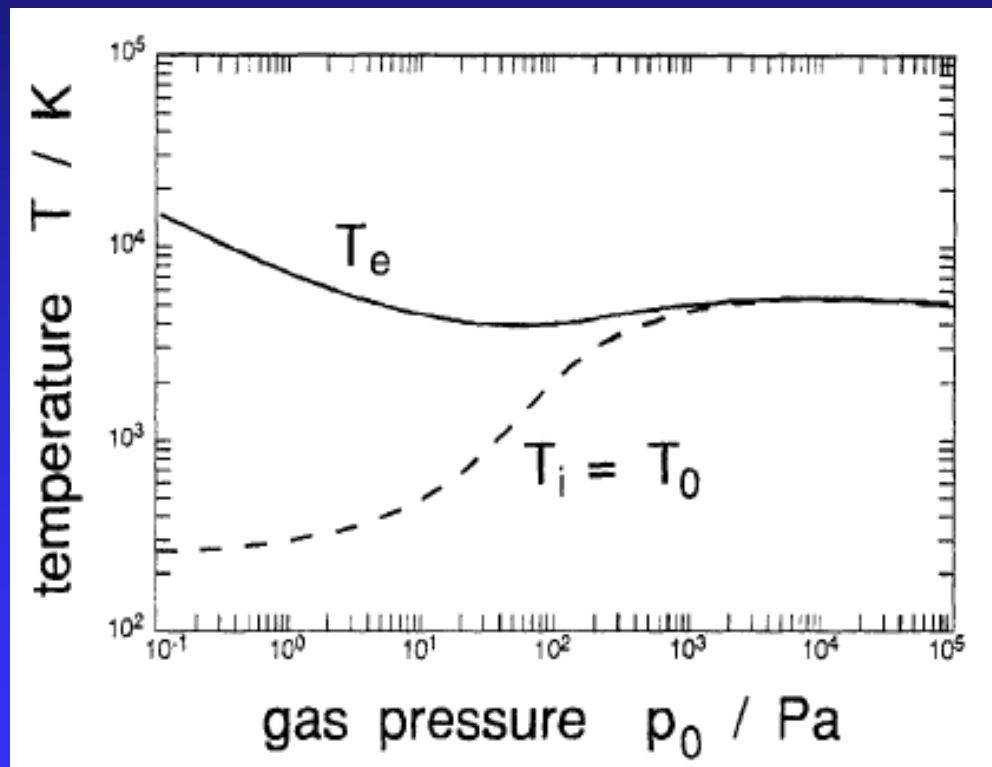

Effects of mag. field on the positive column plasma  
(no significant effect on the cathode region structure)

## STRIATIONS

**NOT TRUE EXPLANATION** : [https://en.wikipedia.org/wiki/Glow\\_discharge](https://en.wikipedia.org/wiki/Glow_discharge) „Bands of alternating light and dark in the positive column are called striations. Striations occur because only discrete amounts of energy can be absorbed or released by atoms, when electrons move from one quantum level to another. The effect was explained by Franck and Hertz in 1914.“

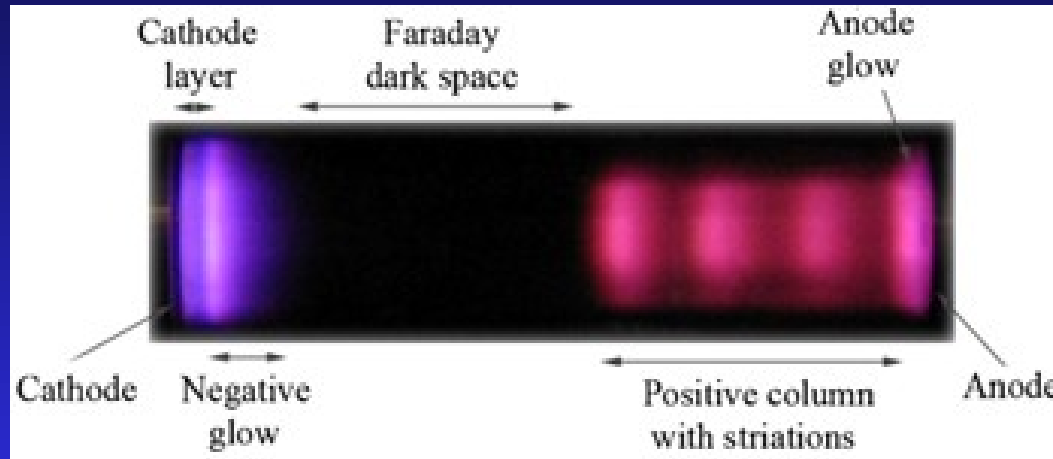

- **J.P. Boeuf: „Ionization waves (striations) in a low-current plasma column revisited with kinetic and fluid models“** Physics of Plasmas **29**, 022105 (2022)
- „An essential aspect of the instability leading to the development of these striations is **the non-Maxwellian nature of the electron energy distribution function** in the uniform electric field prior to the instability onset, resulting in an electron diffusion coefficient in space much larger than the energy diffusion coefficient.“

## Non-Maxwellian electron distribution in negative glow



**Hollow cathode glow discharge:** the current of two glow discharges is strongly enhanced when their negative glows are contacted (d is the distance between the cathode and anti-cathode)):

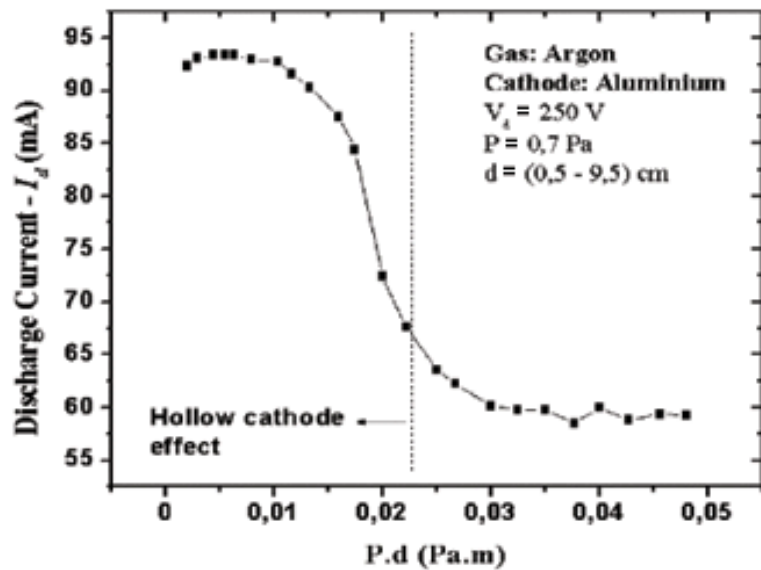
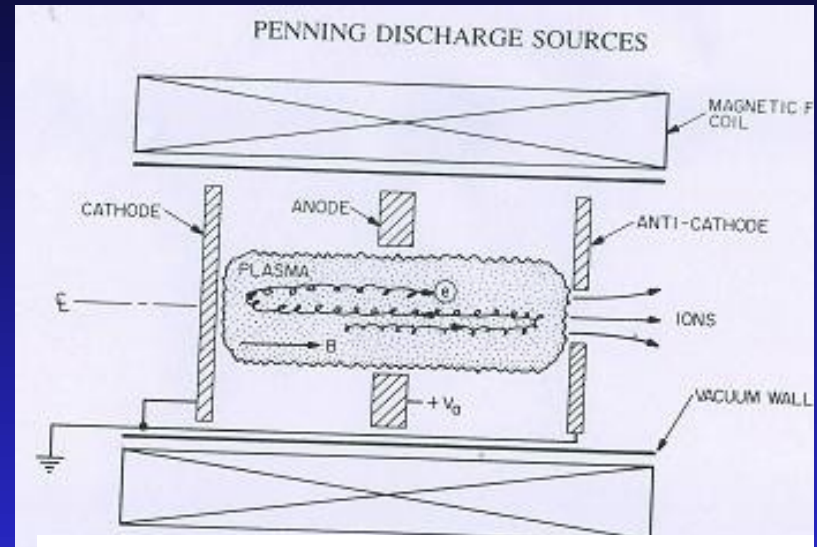
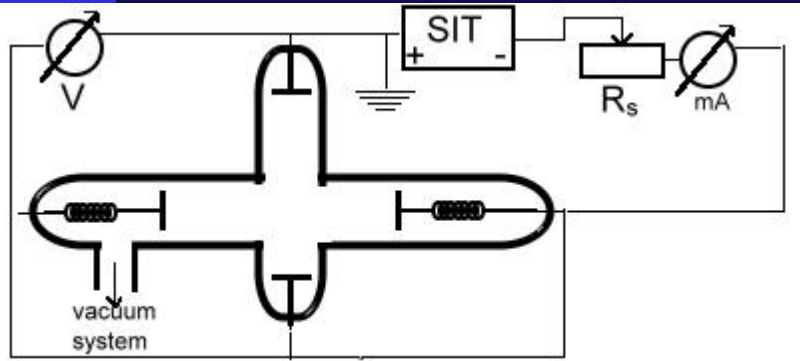
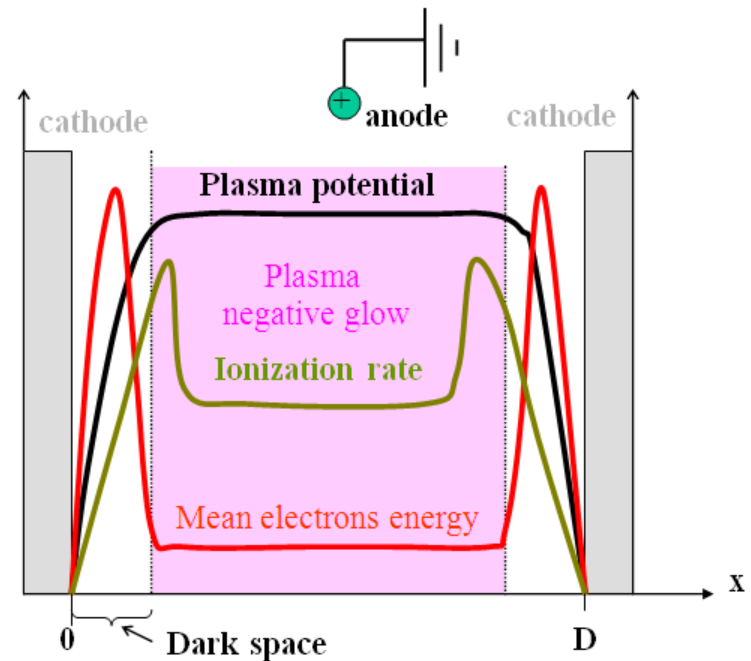
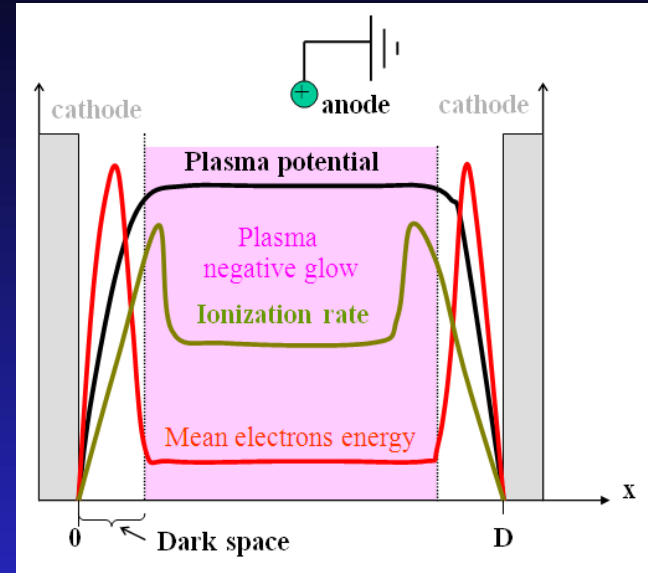
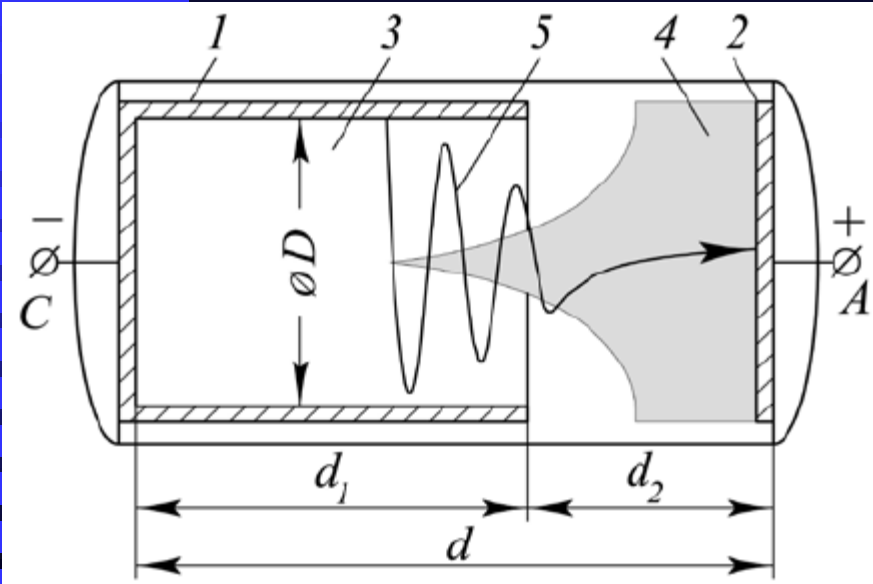

FIG. 2: Hollow Cathode discharge current as a function of the (P.d) parameter.



# A typical geometry of the hollow cathode G.D. :



- 1 – hollow cathode, 2 – anode,
- 3 – positive space charge, 4 – plasma,
- 5 – electron trajectory





# Applications of the positive column plasma:

- „glow discharge lamps“

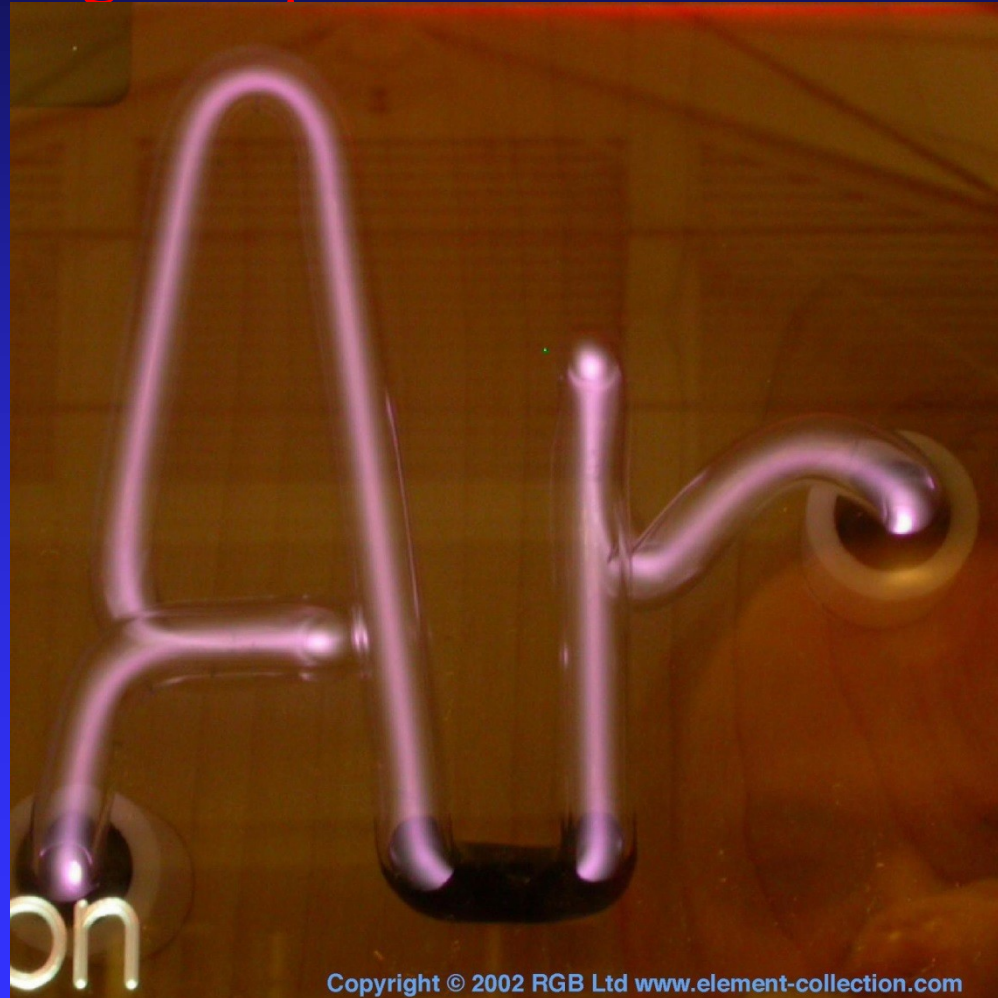

# Glow discharge lamps

[https://en.wikipedia.org/wiki/Gas-discharge\\_lamp](https://en.wikipedia.org/wiki/Gas-discharge_lamp)

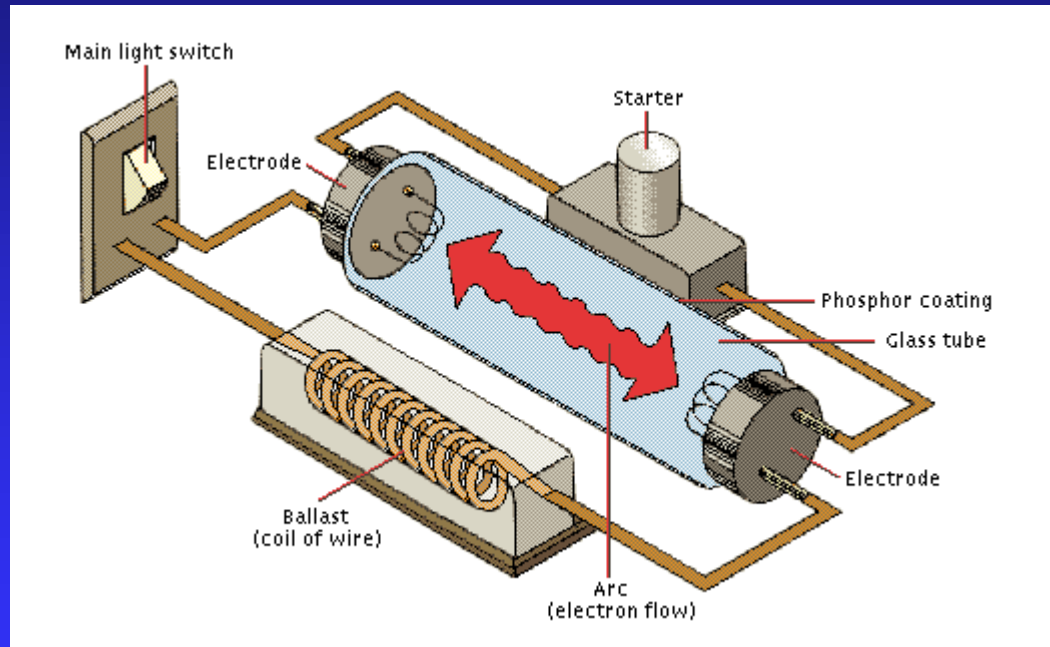

## Industry-standard solid-state ballast circuit for CFLs

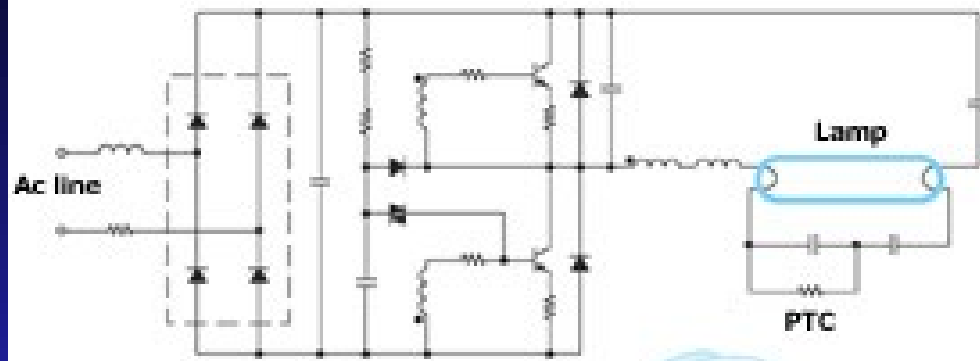

**TYPICAL CFL**

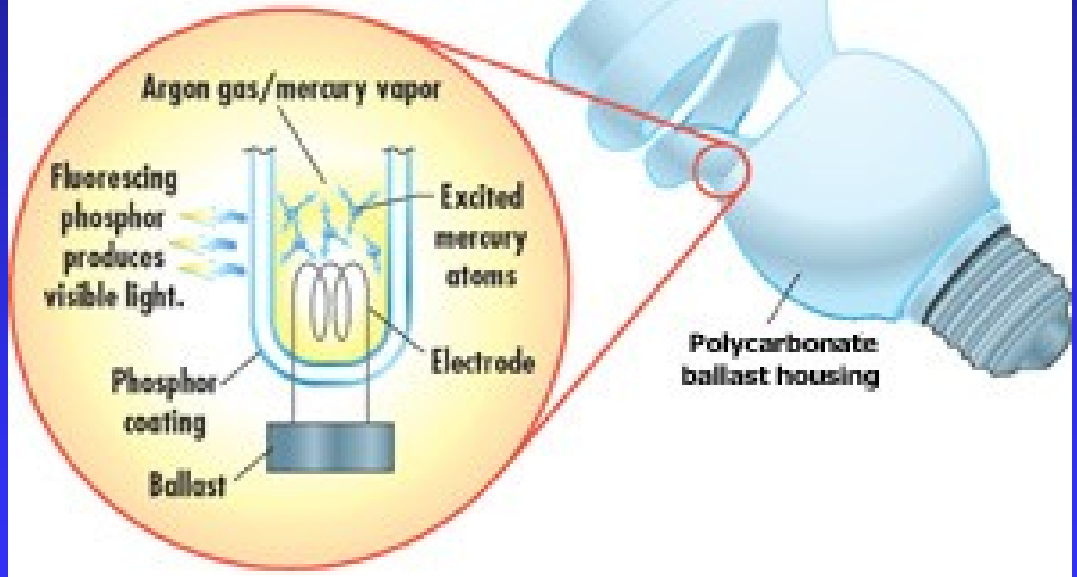

# Germicidal lamps – without the fluorescent layer:



# Gas (gas discharge) lasers:

- A laser is a coherent and highly directional radiation source. LASER stands for Light Amplification by Stimulated Emission of Radiation.
- A laser consists of at least three components:
- a gain medium that can amplify light that passes through it
- an energy pump source to create a population inversion in the gain medium
- two mirrors that form a resonator cavity
- The gain medium can be solid, liquid, or gas and the pump source can be an electrical discharge, a flashlamp, or another laser. The specific components of a laser vary depending on the gain medium and whether the laser is operated continuously (cw) or pulsed. The following headings describe specific laser designs.

Gas lasers are typically excited by gas discharges

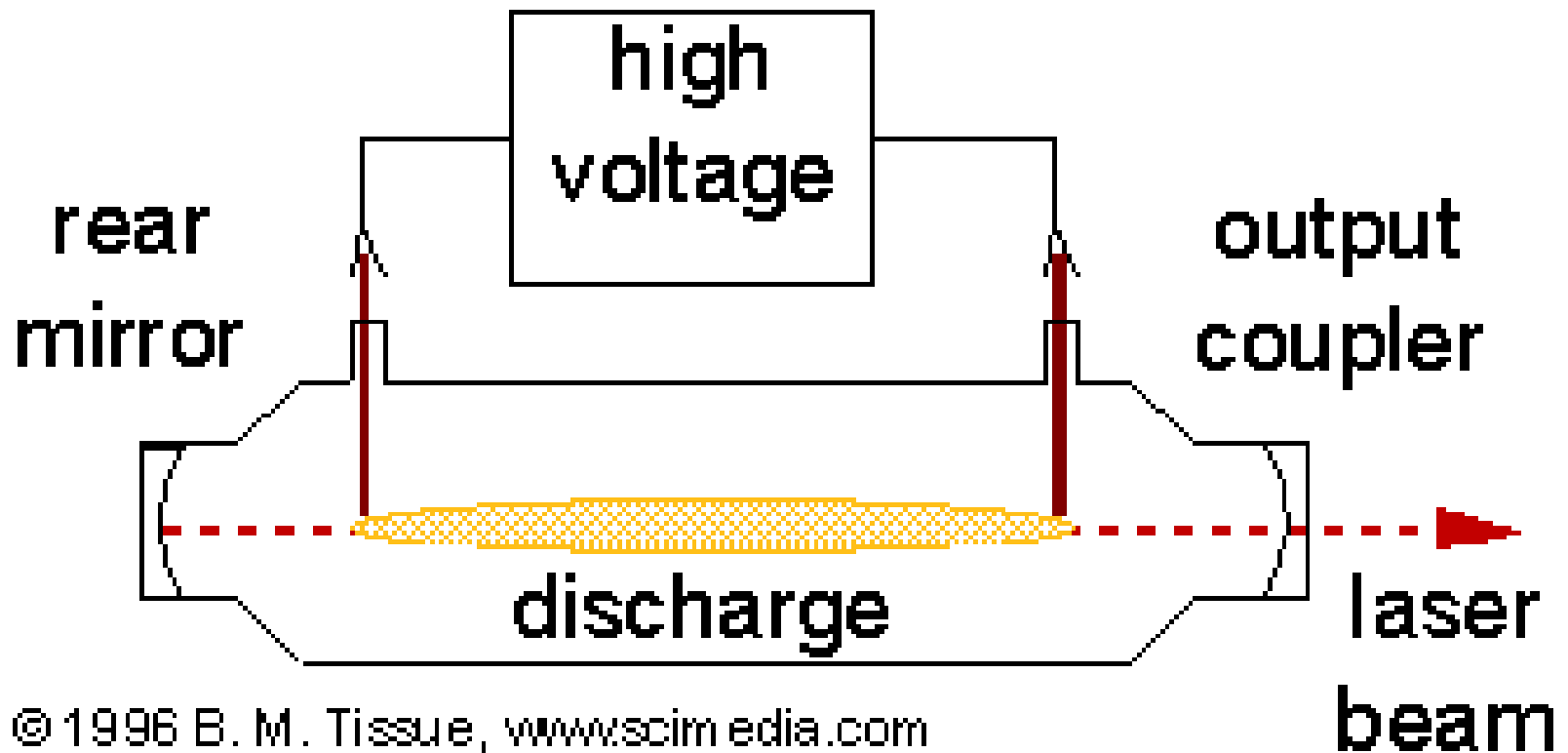



excimer : ArF\* - 248 nm, XeCl\* - 308 nm (pulsed)

nitrogen : 337 nm (pulsed)

He-Ne : 632.8 nm (cw)

Ar ion : 488, 541 nm (cw)

CO<sub>2</sub> : 10.6 μm (cw or pulsed)

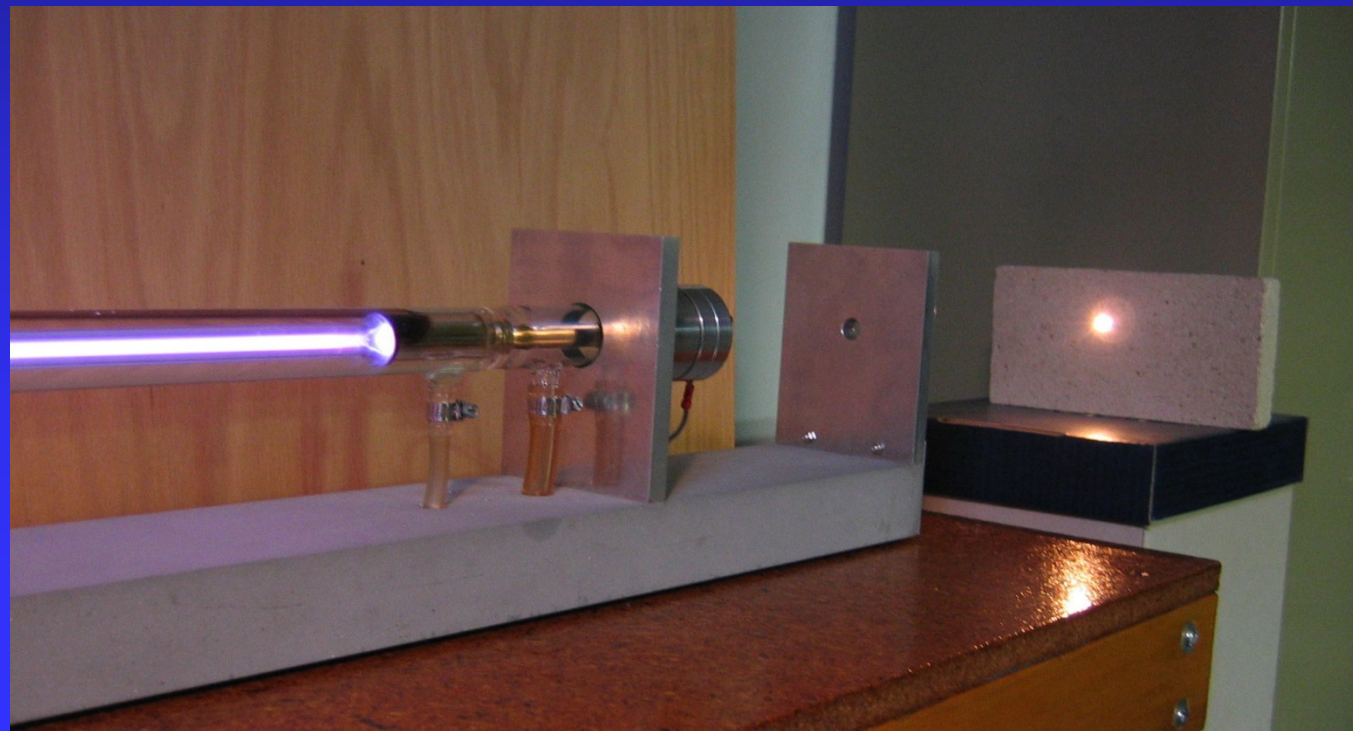
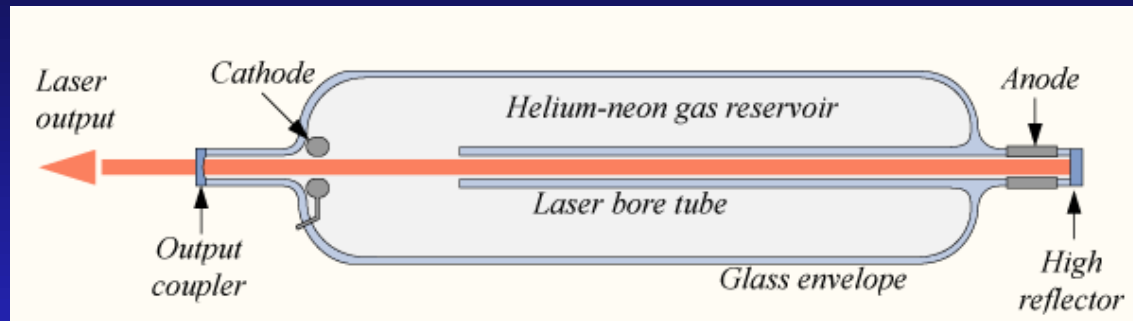

# Excimer lasers and lamps, energy efficiency as high as 40% !

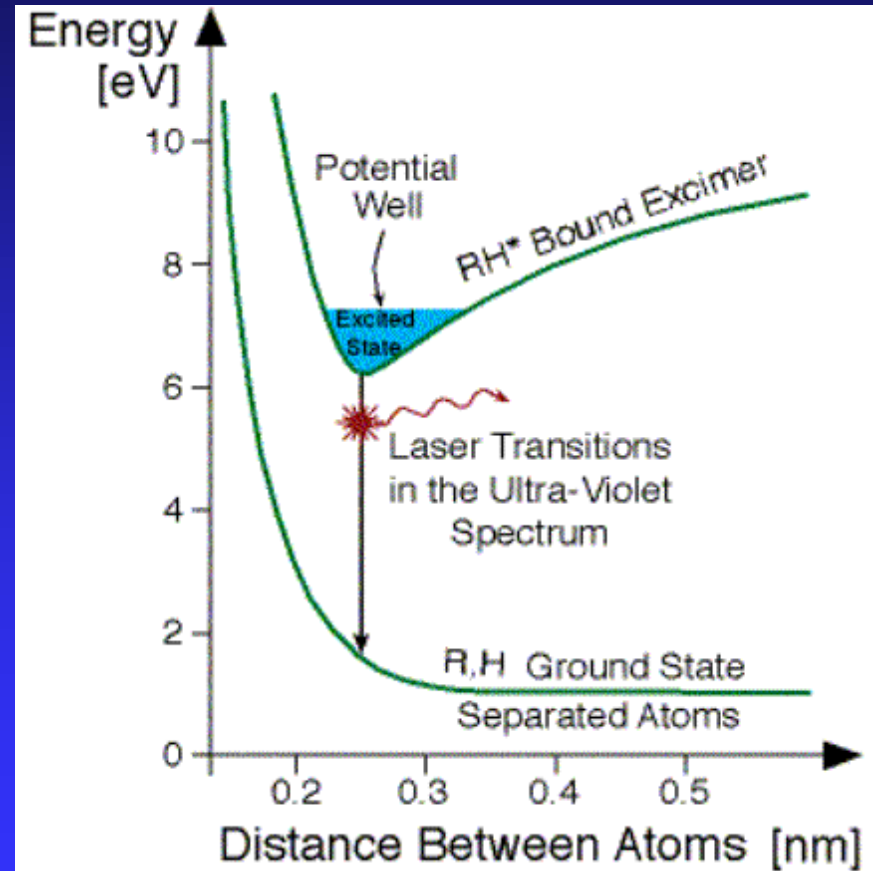
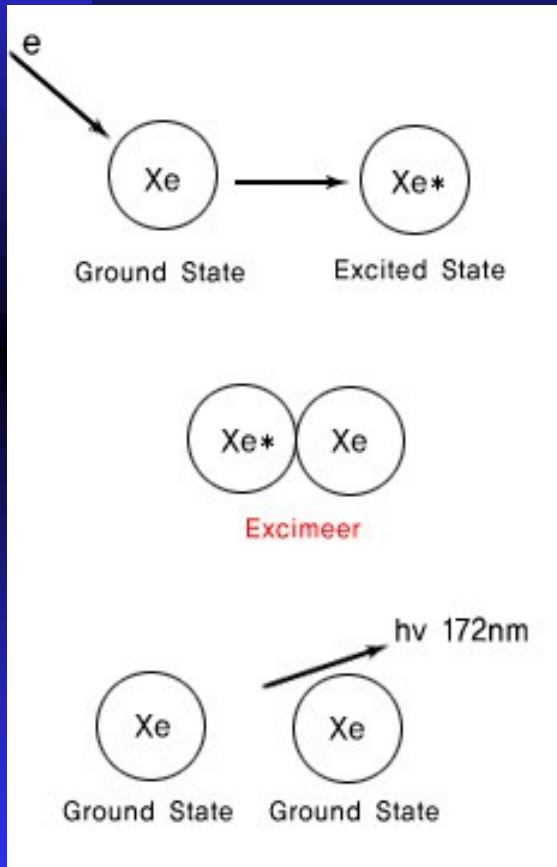



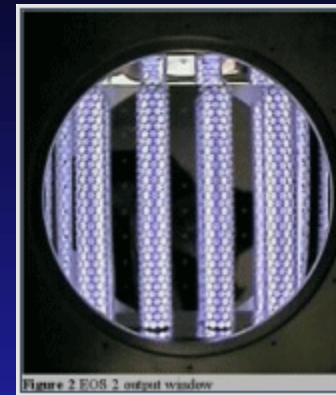
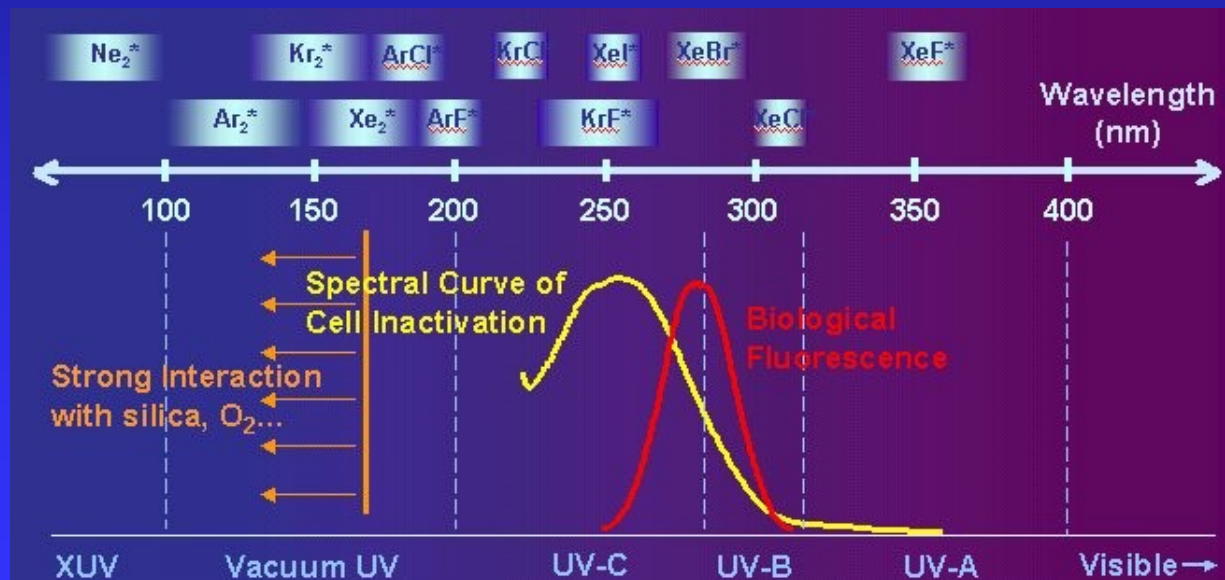
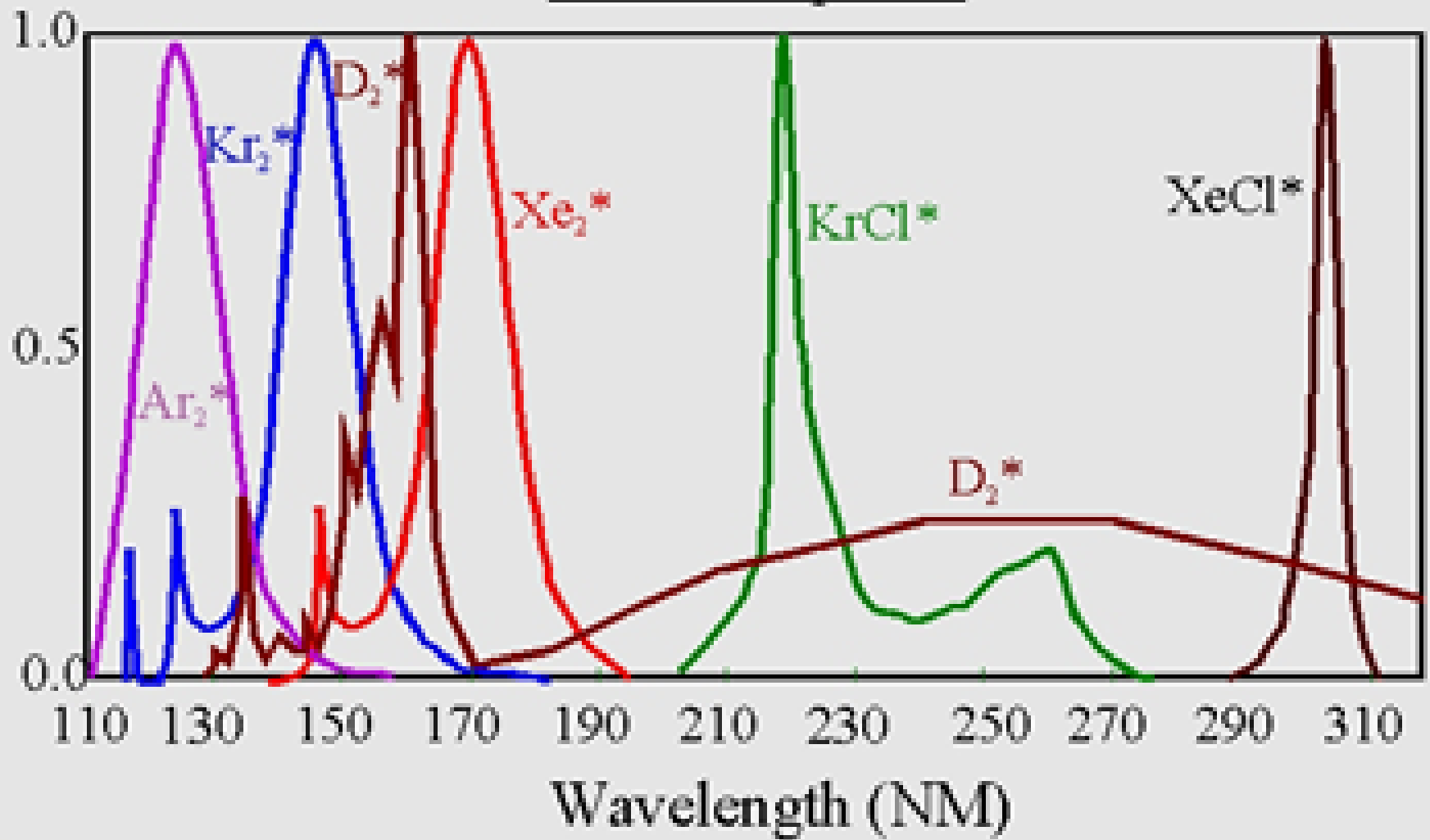

Figure 2 ROS 2 output window



## Excimer Spectra



# Thyatron

A thyatron is one kind of tube filled with gas and it is used like a controlled rectifier as well as a high power electrical switch.

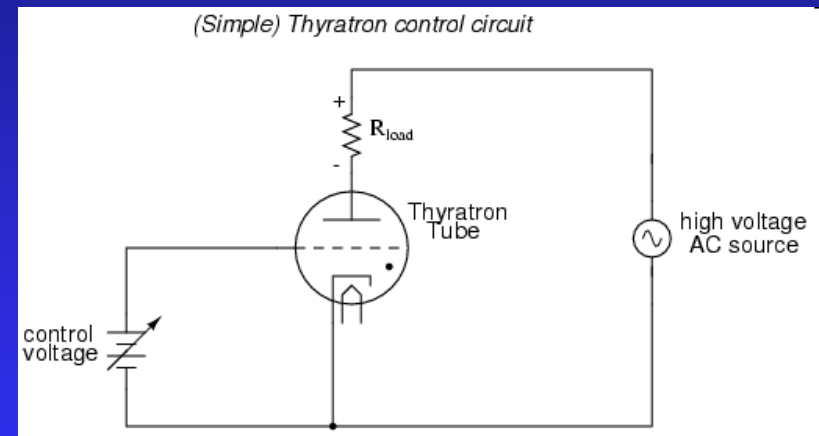
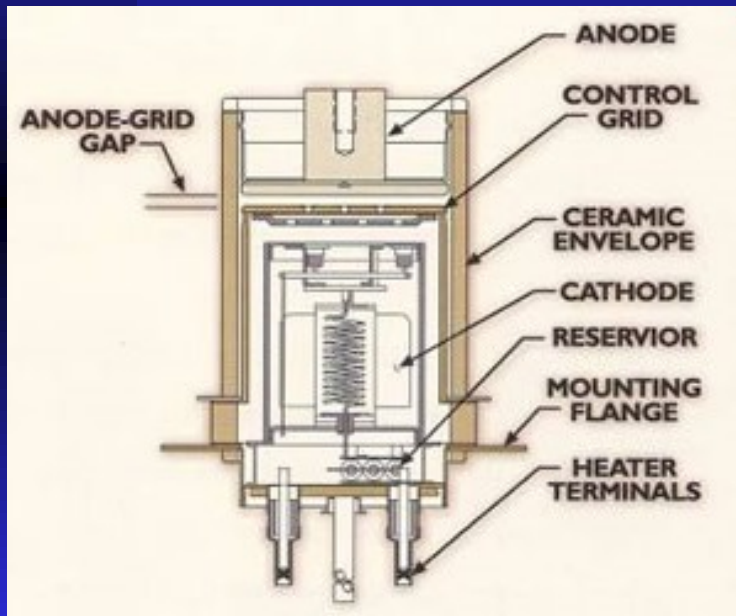

## Applications of cathode phenomena occurring in G.D.

- cathode sputtering

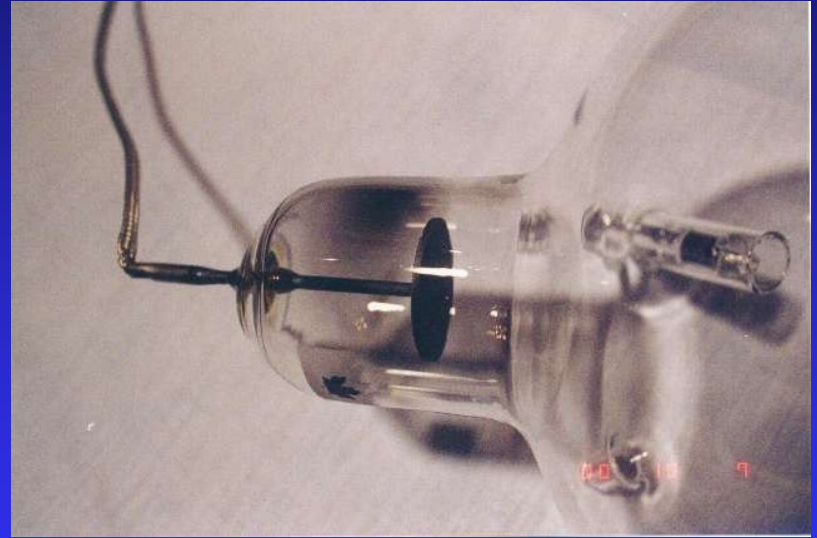
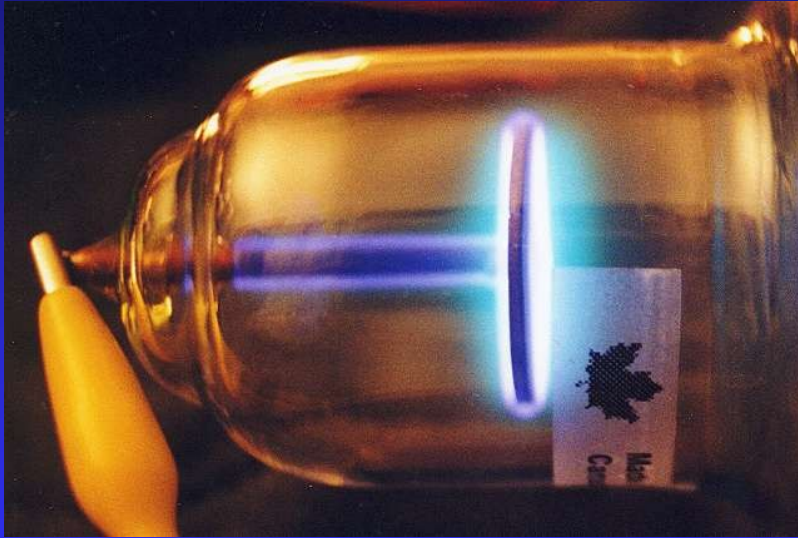

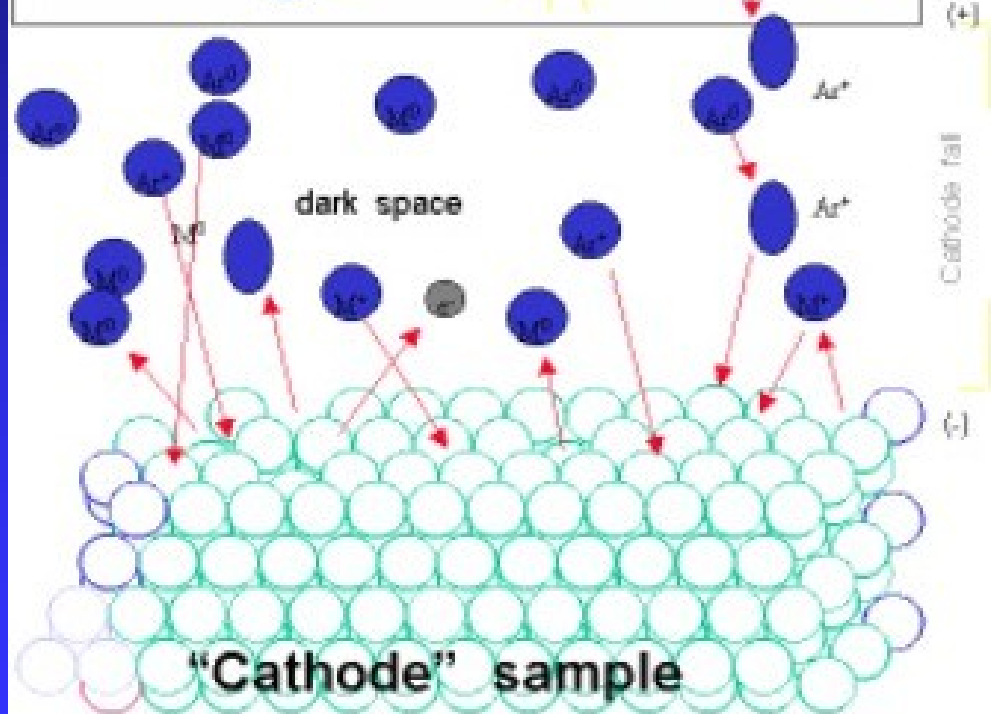
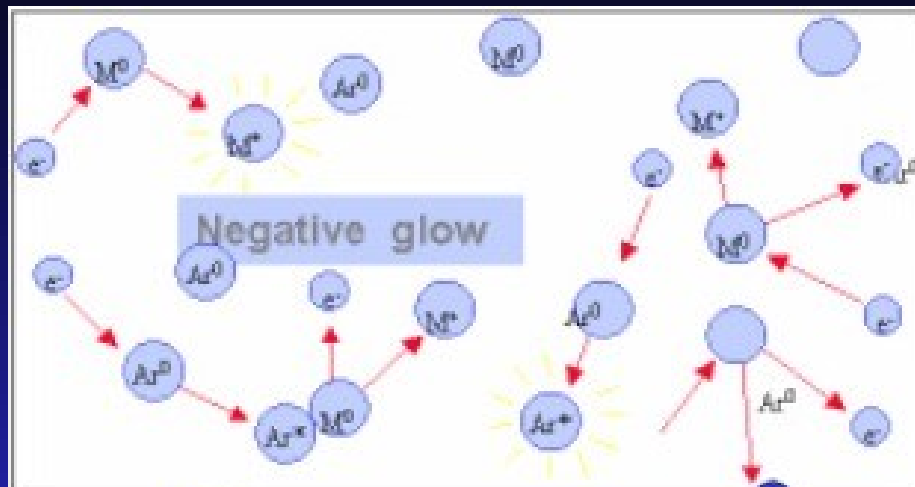

# Magnetron

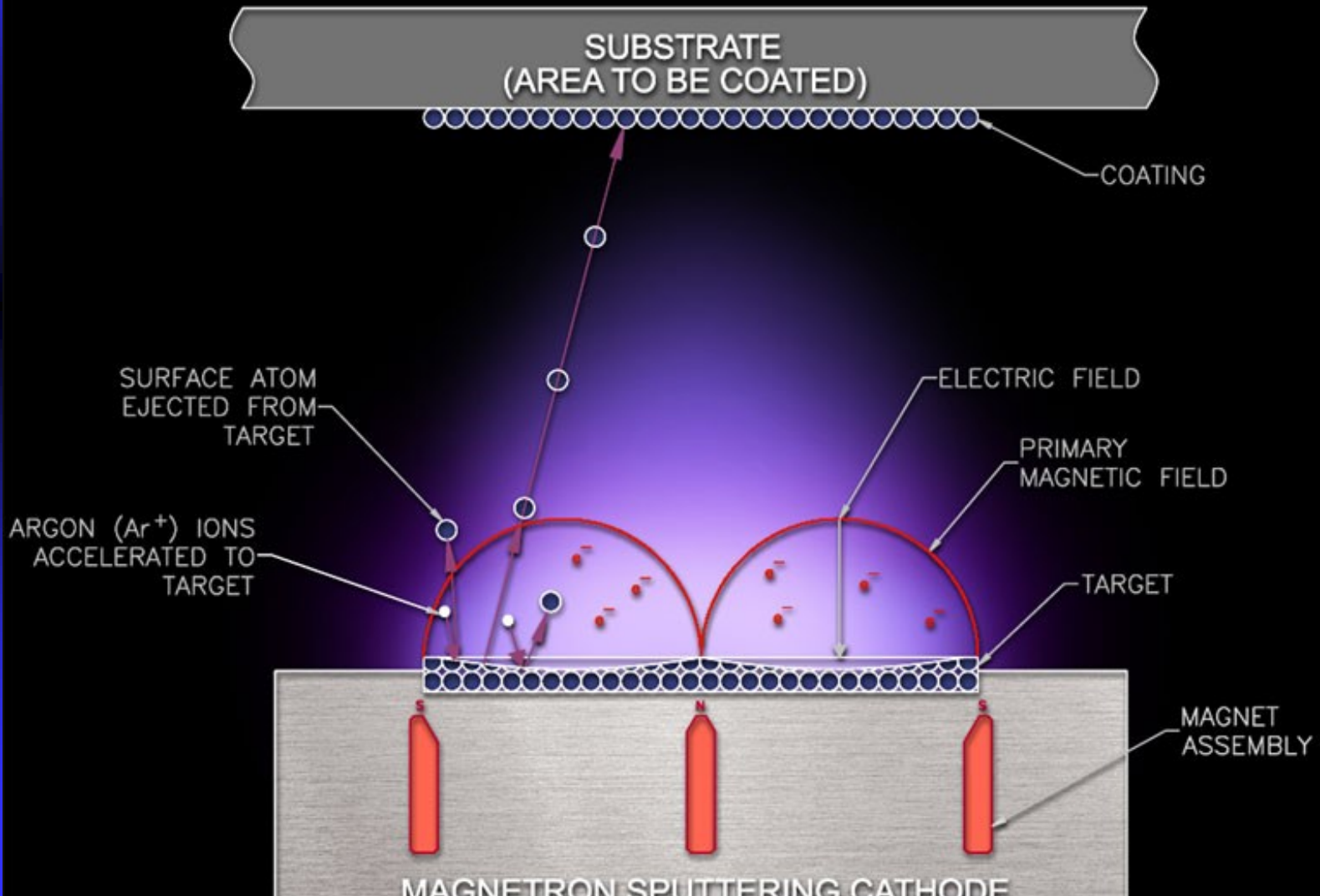



Magnetron  
source

Titanium target

Excited argon  
gas

Sputtered  
atoms in  
direction  
of arrow

Metal  
substrate

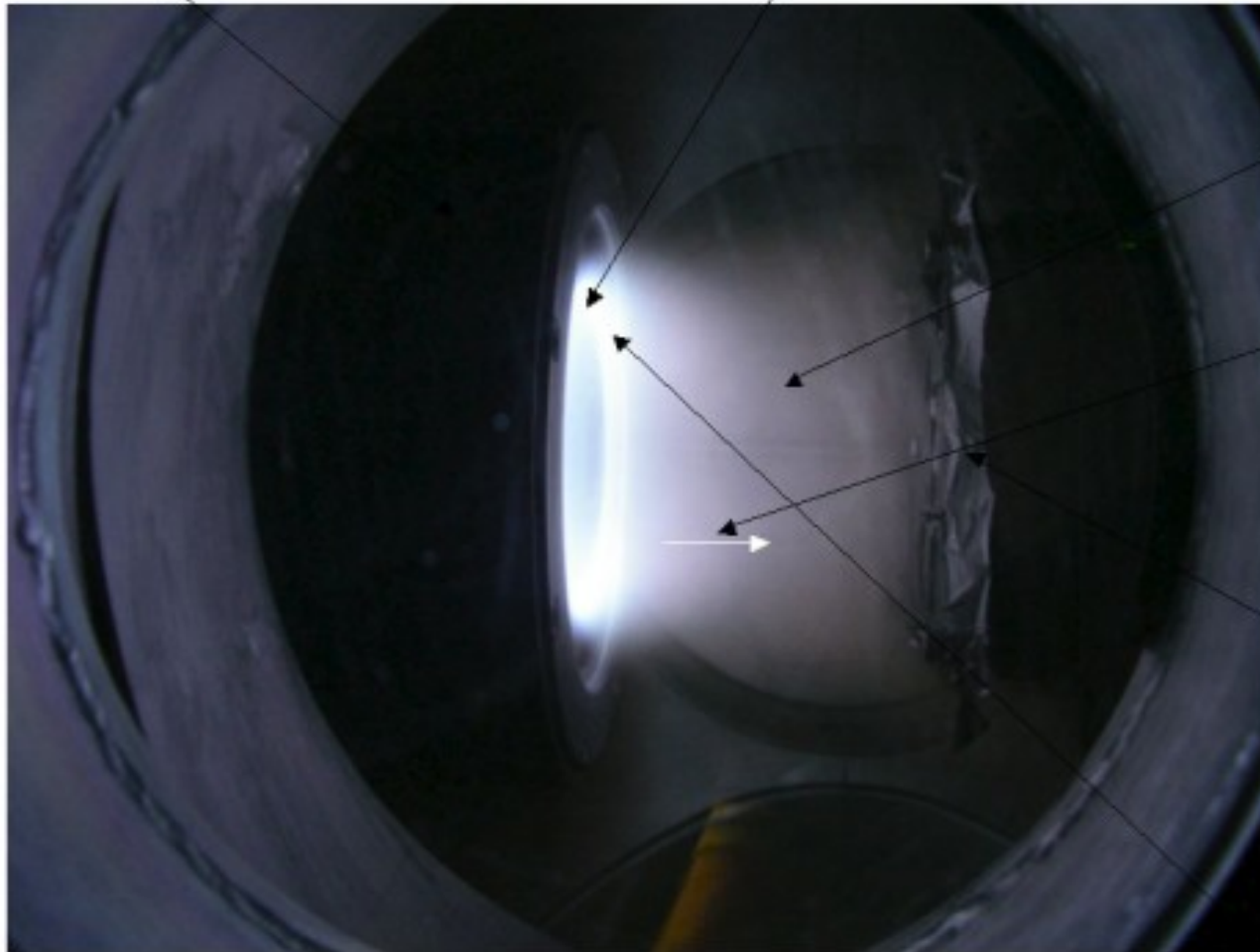

Bright plasma ring – electrons trapped in the magnetic field which emanates from a set of magnets behind the target

## ■ Targets:





# Magnetron with the hollow cathode

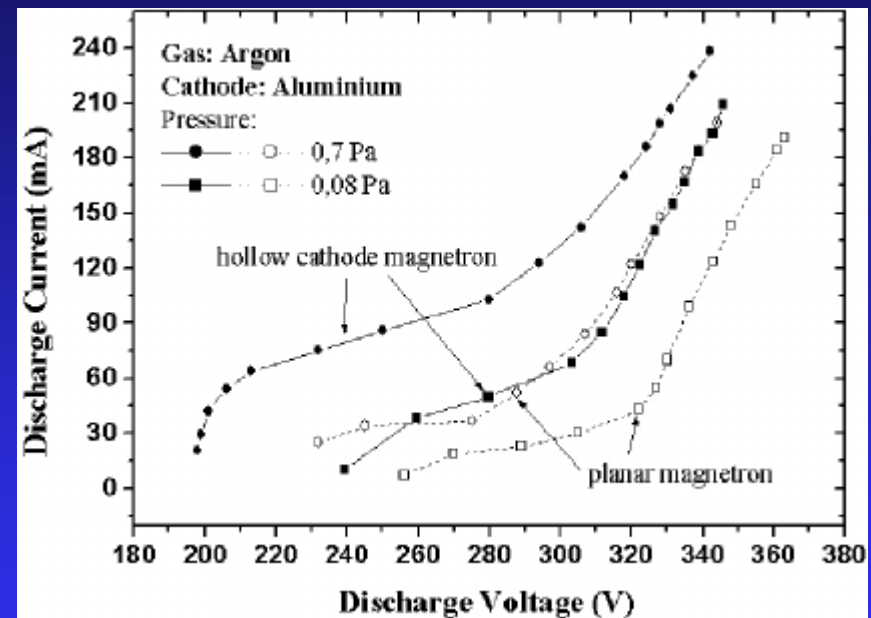
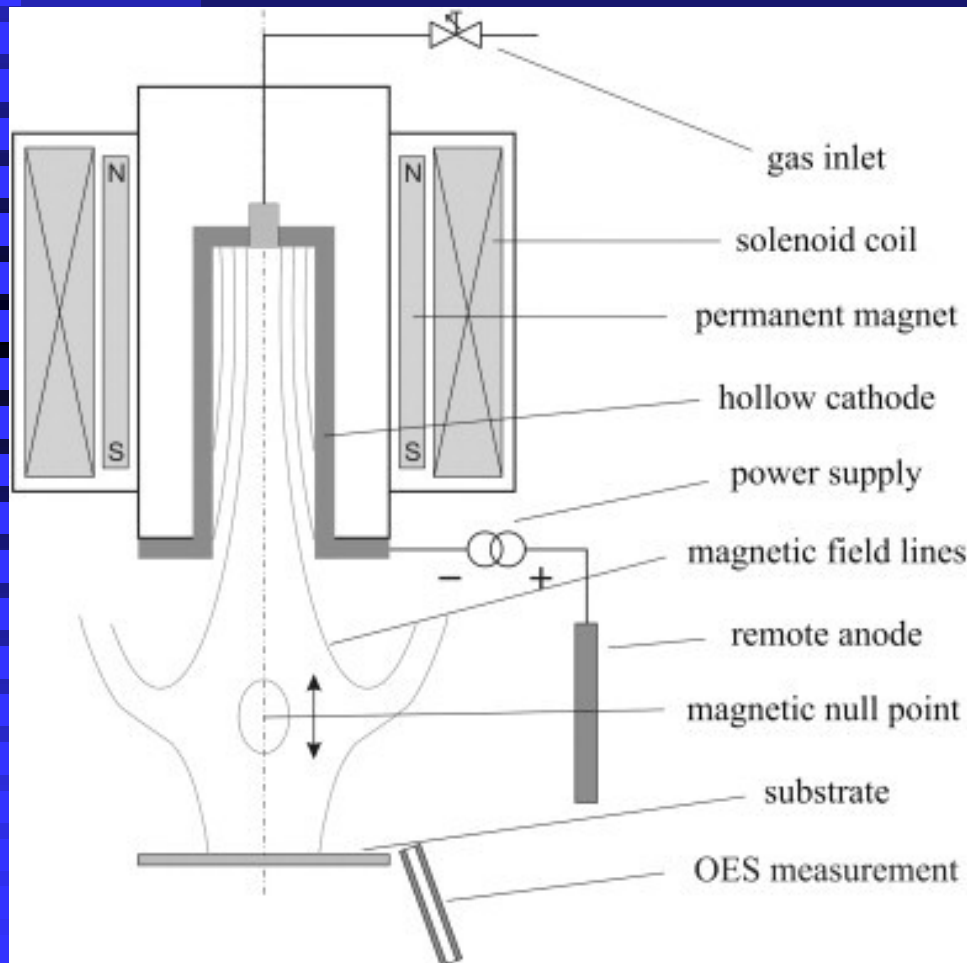

# Plasma nitridation:

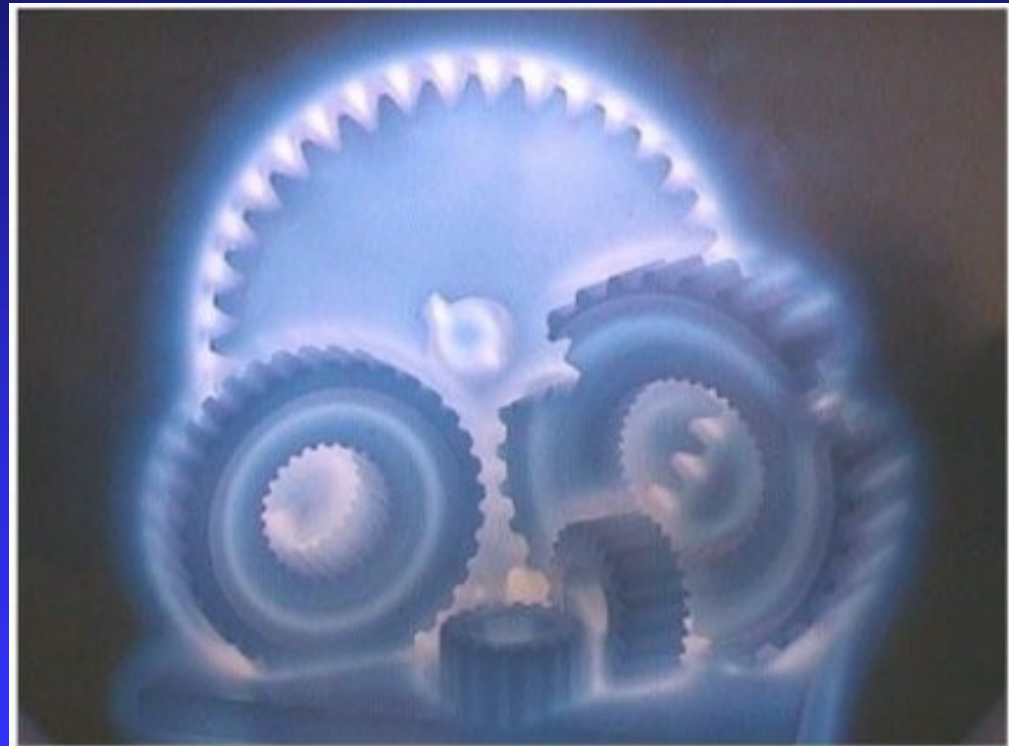

# Plasma nitridation:

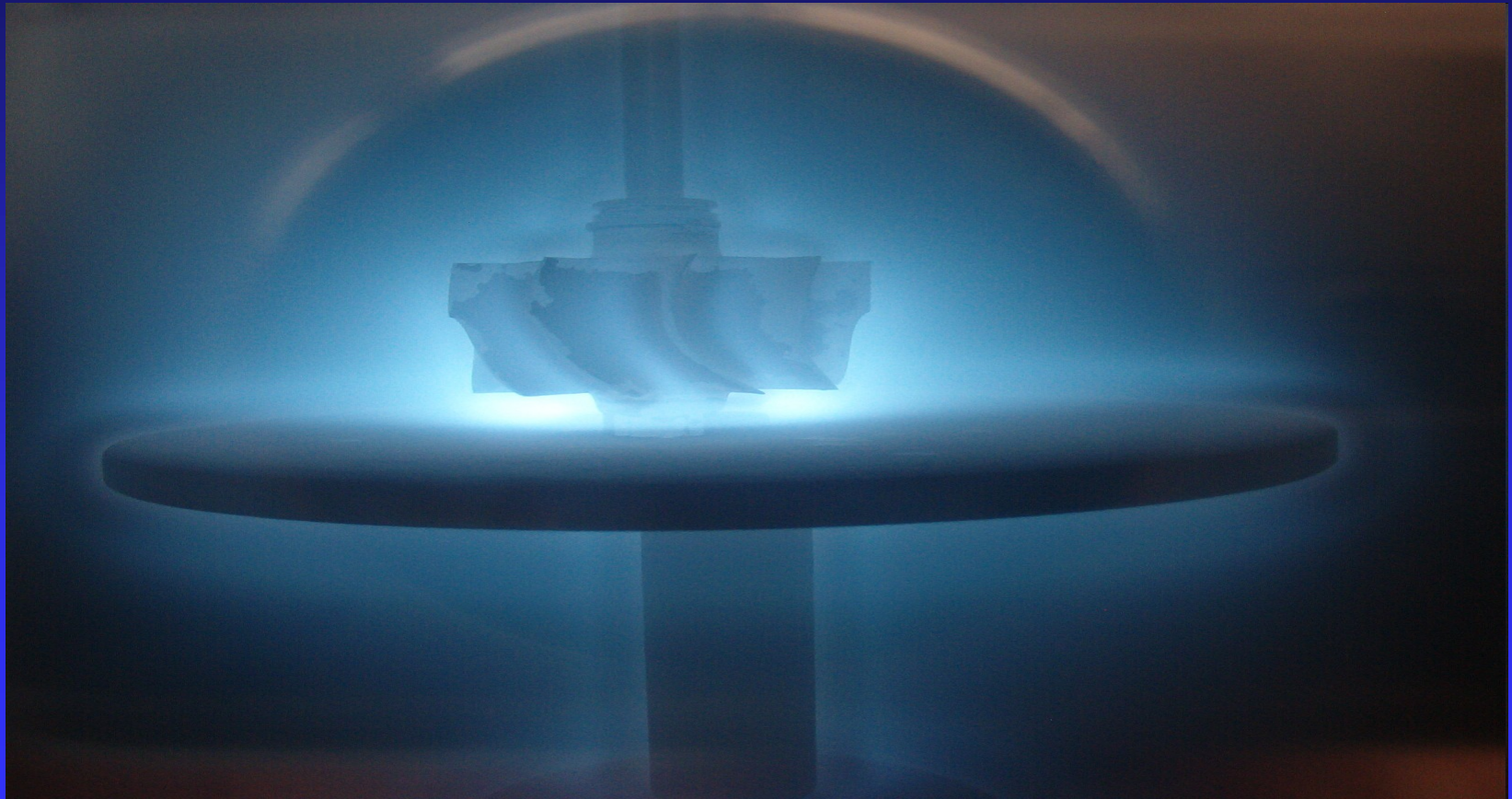

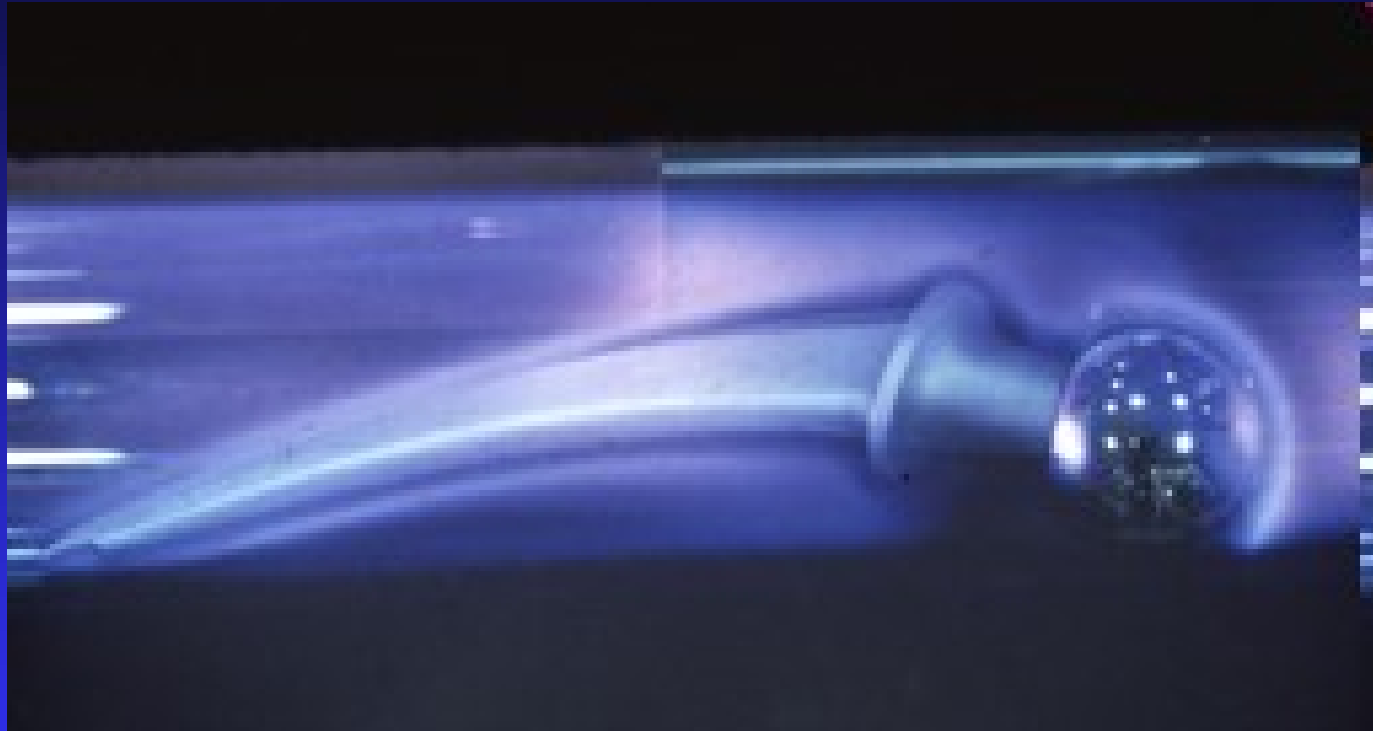

# Plasma Immersed Ion Implantation

- The plasma immersion ion implantation process is of potentially great significance for the modification of surfaces, since in principle it permits the implantation of ions into a surface without the usual line-of-sight restrictions of ion-beam techniques.

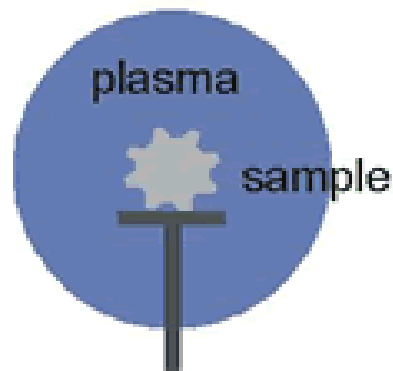

$t = 0, U = 0$

sample immersed  
in plasma

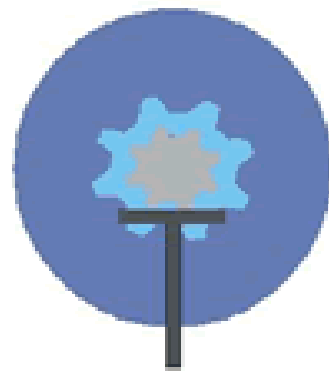

$t = t_1, U = U_0$

voltage pulse  $U_0$  from  $t_1$  to  $t_2$   
displacement of electrons ( $\sim 1$  ns)  
acceleration of ions ( $\sim 100$  ns)  
plasma sheath expansion ( $\sim 10 \mu\text{s}$ )

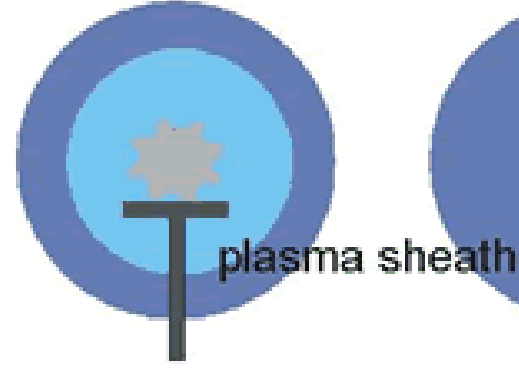

$t_1 < t < t_2, U = U_0$

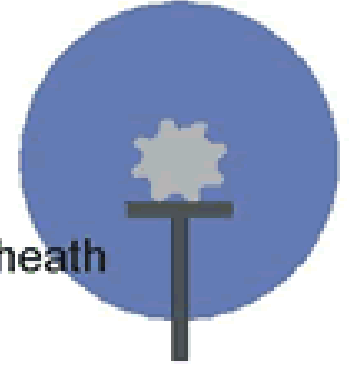

$t > t_2, U = 0$

Plasma  
regeneration

**A large vacuum chamber (1m diameter & 2m length) with plasma produced by the impact ionization of neutrals by thermionic electrons.**

**A magnetic cusp to enhance plasma density.**

**A 50 kv DC supply with a hard tube modulator**





# Gliding arc (GLIDARC) in fact **Gliding Glow Discharge**



Figure 2.

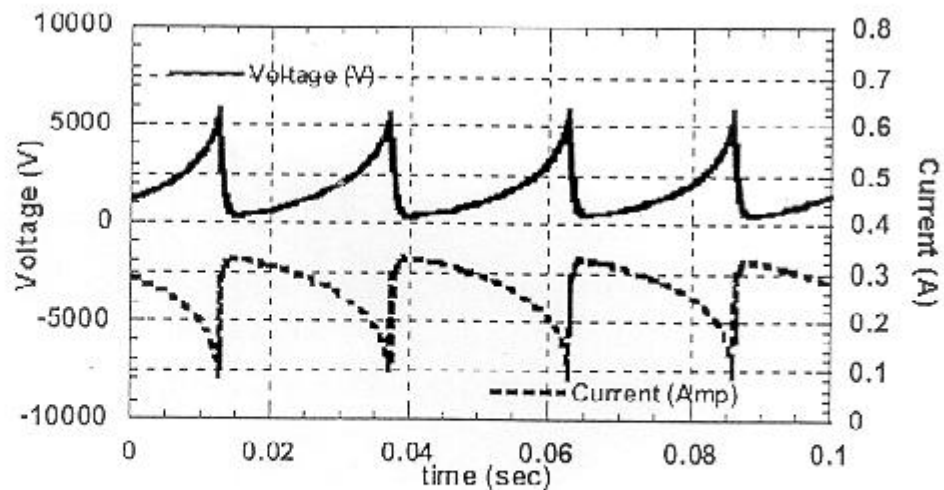
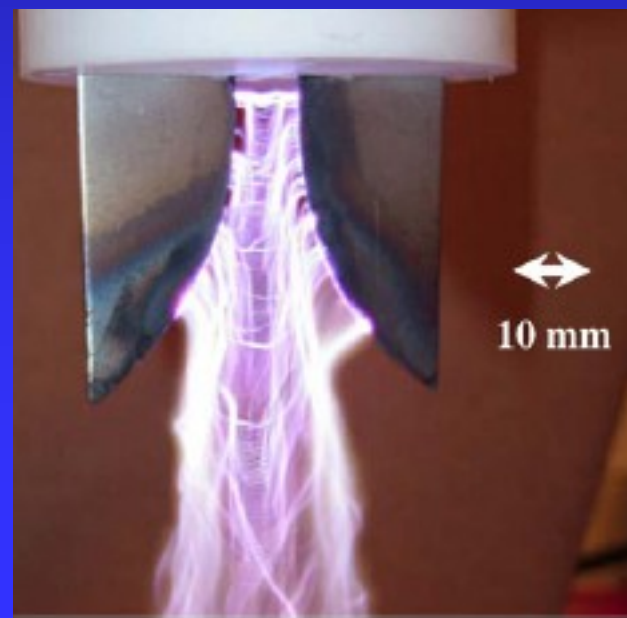
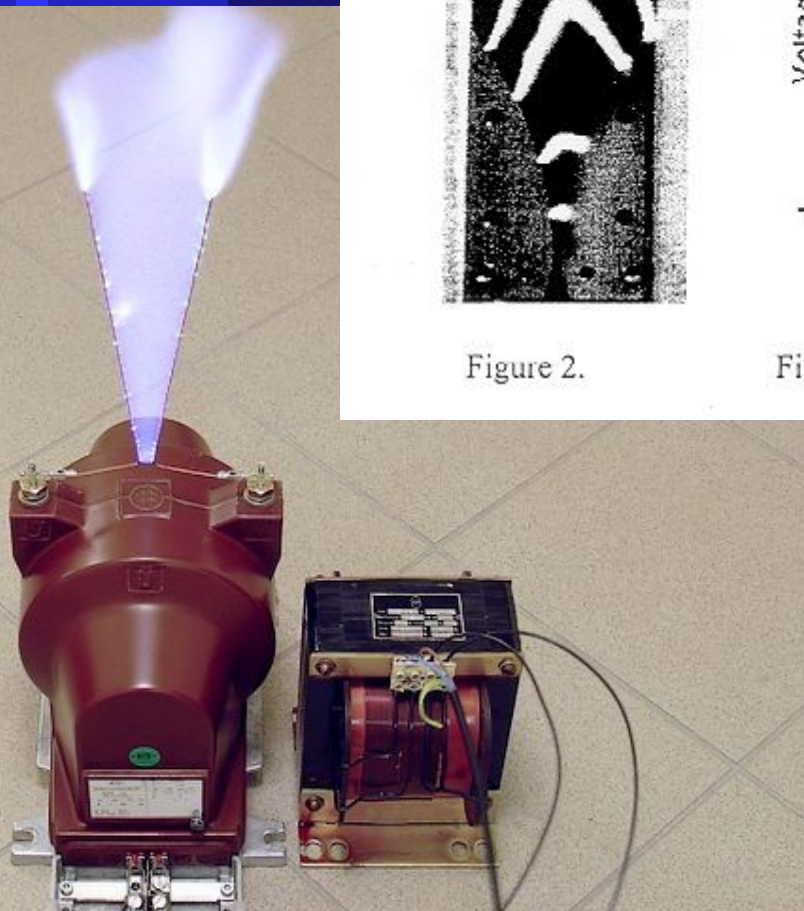

Figure 3. Current and voltage waveforms of the gliding arc discharge.





# Gliding Arc Discharges

Basic System Overview

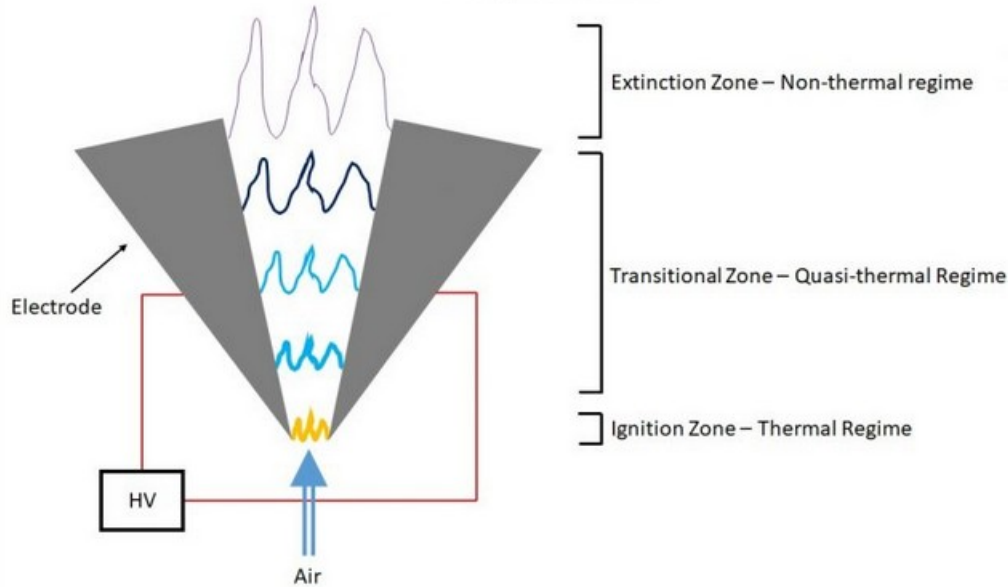

<https://appliedionsystems.com/diy-vortex-stabilized-gliding-arc-discharge/>



Figure 2.

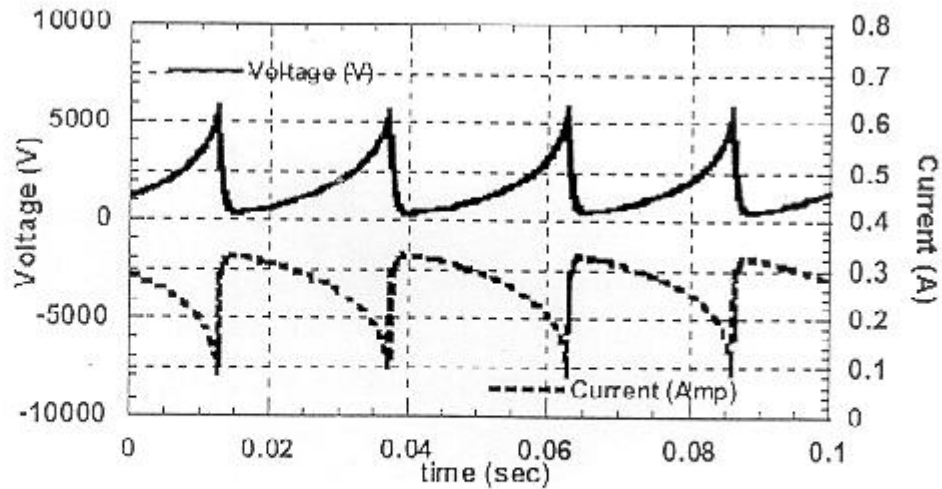
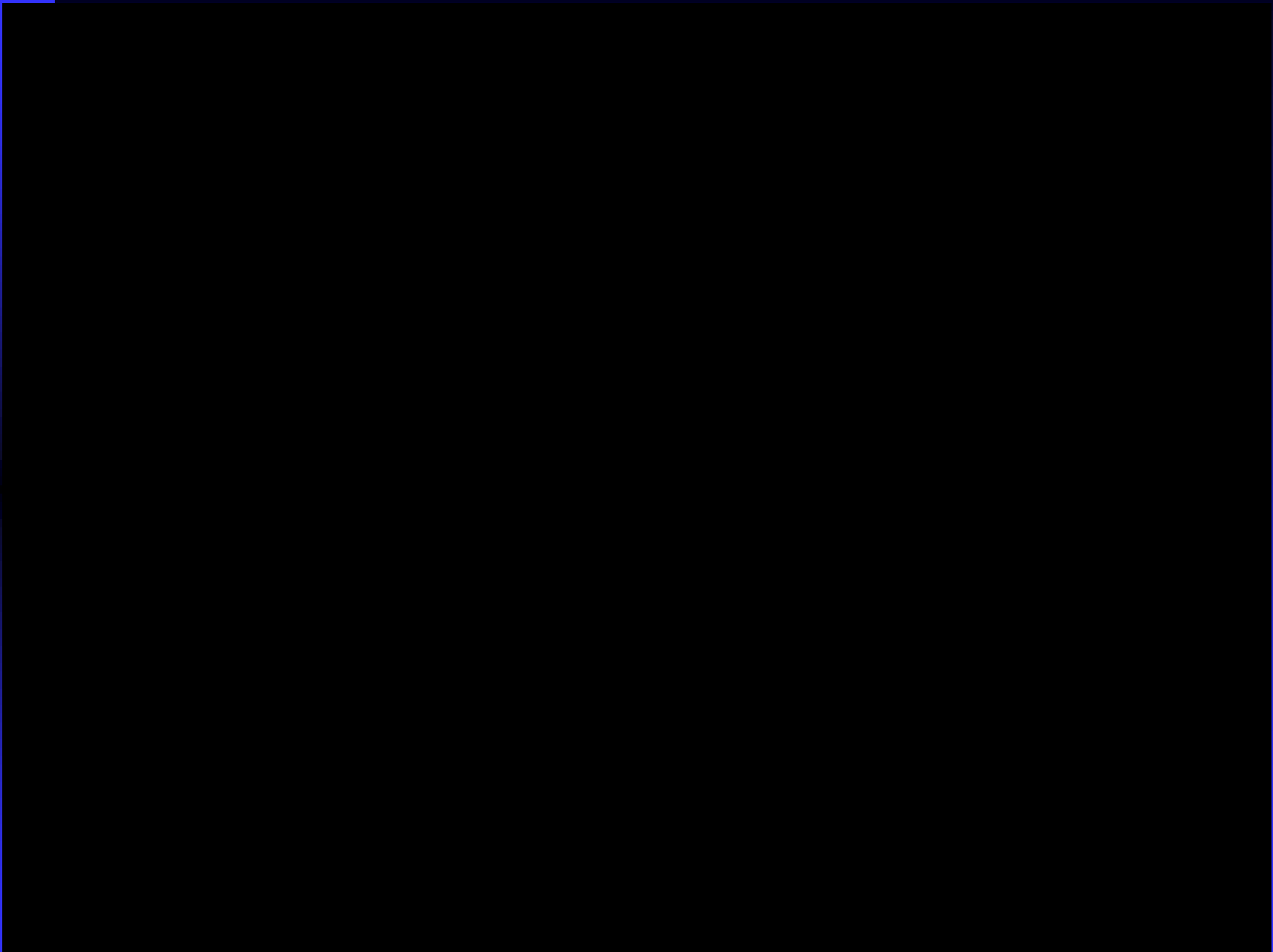

Figure 3. Current and voltage waveforms of the gliding arc discharge.



# Where is the „corona“ in the parallel plane geometry ?

