

# Electron and Energy Transfer

## Chapter 7 (pp.383-481)

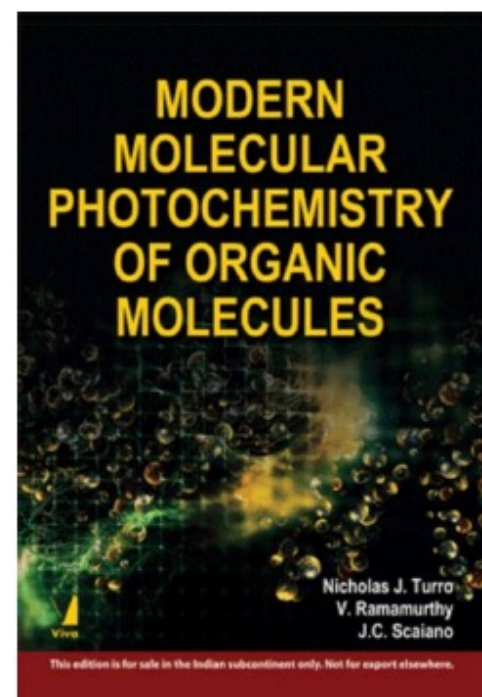

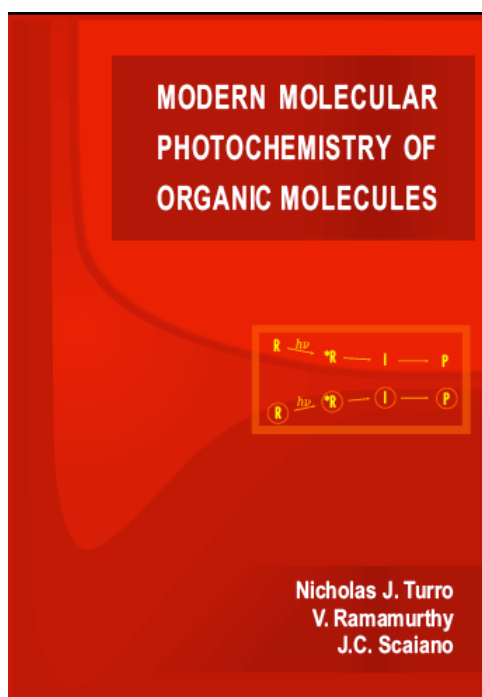

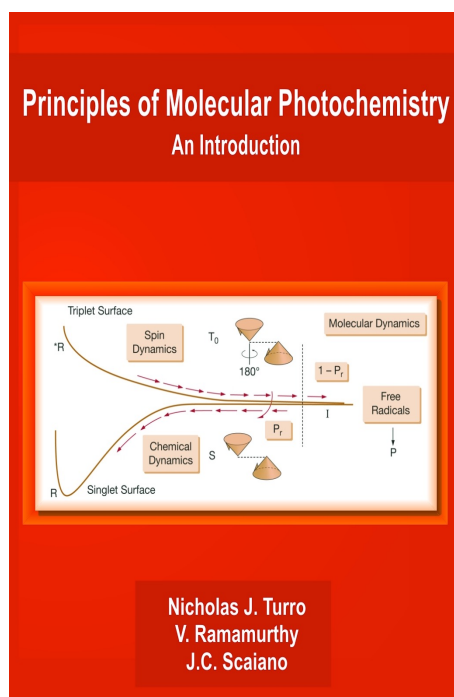

Survival Strategy: Photosynthesis



# Electron Transfer-Phenomenon

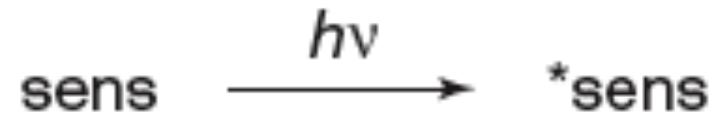

# Electron Transfer-Orbitals

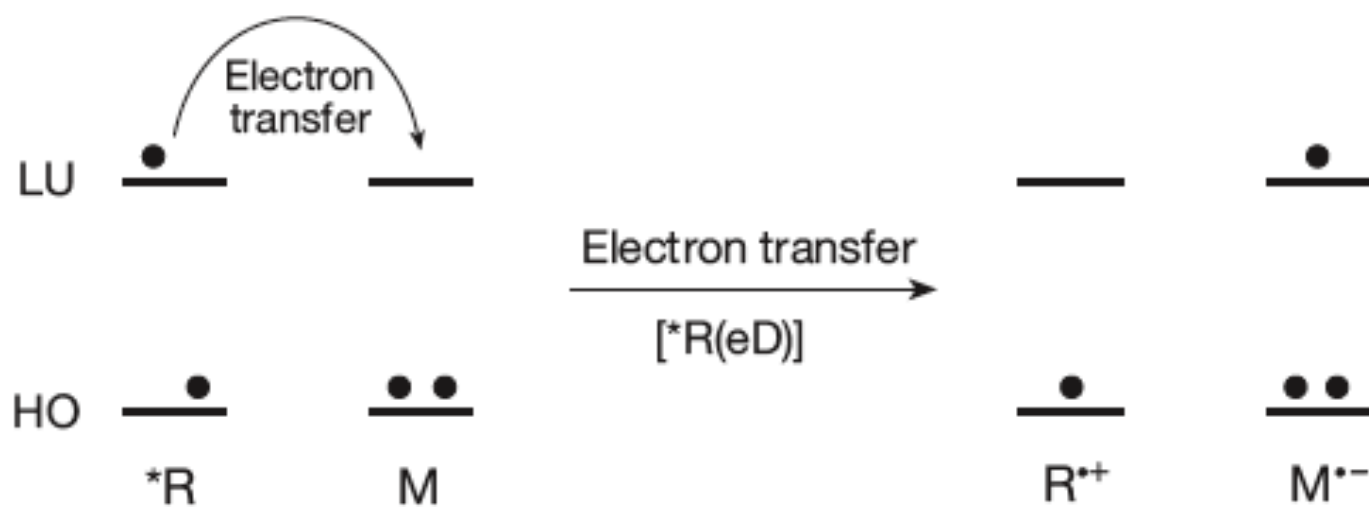



# Electron and Hole

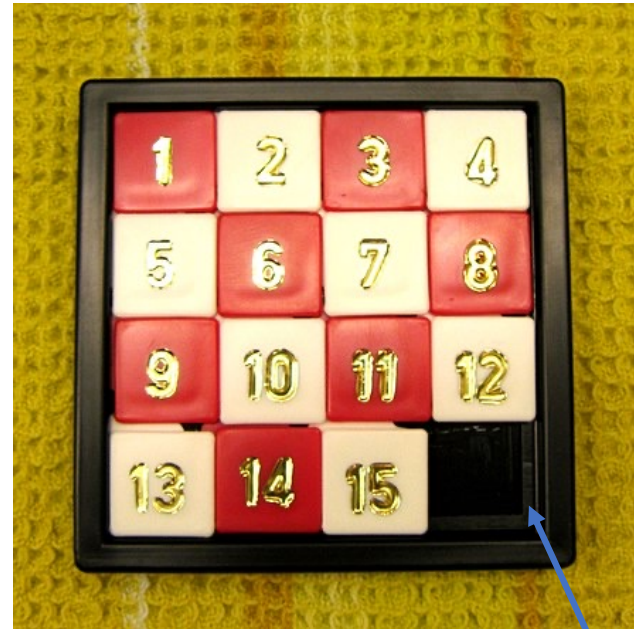
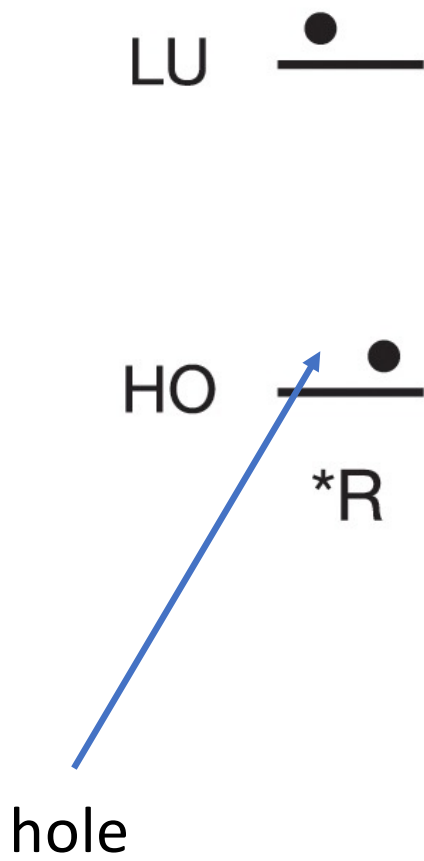

hole

# Hole and Electron Transfer

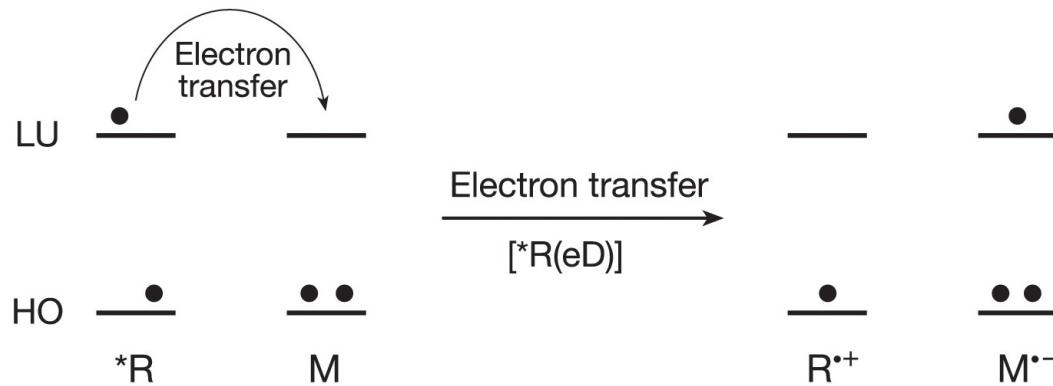

In the physics literature, a half-filled HO is considered a "positive hole" in the electronic framework of a molecule;  $*R$  is viewed as simultaneously possessing both a positive hole (one electron in the half-filled HO) and one electron in the half-filled LU.

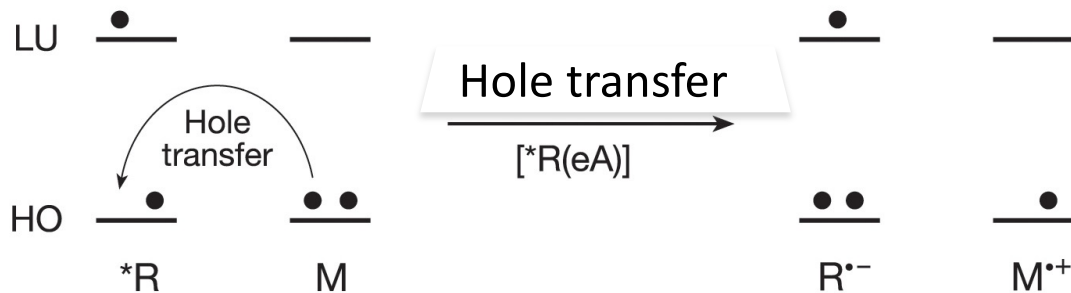

The term **electron transfer** is usually employed for single electron transfer involving **LUs** of the donor and acceptor; the term **hole transfer** is usually employed for electron transfer involving the **HOs** of the donor and acceptor



# electron transfer

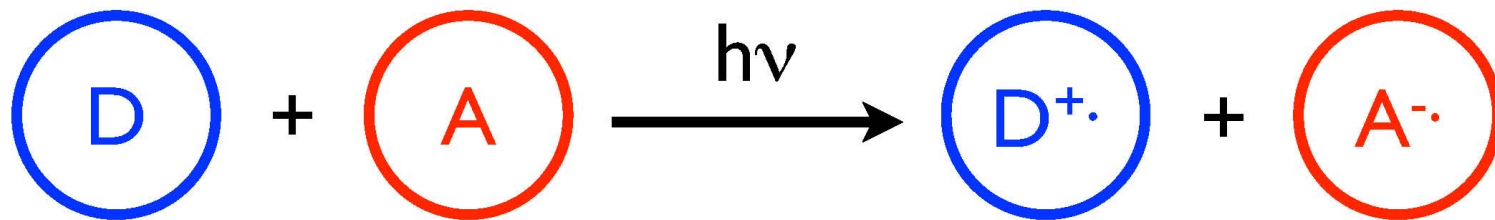

- *is it difficult to achieve photo-induced electron transfer between two molecules?*

# requirements for charge separation

- there should be a *thermodynamic driving force*  $\Delta G < 0$
- *rate should be high enough to compete with excited state deactivation*

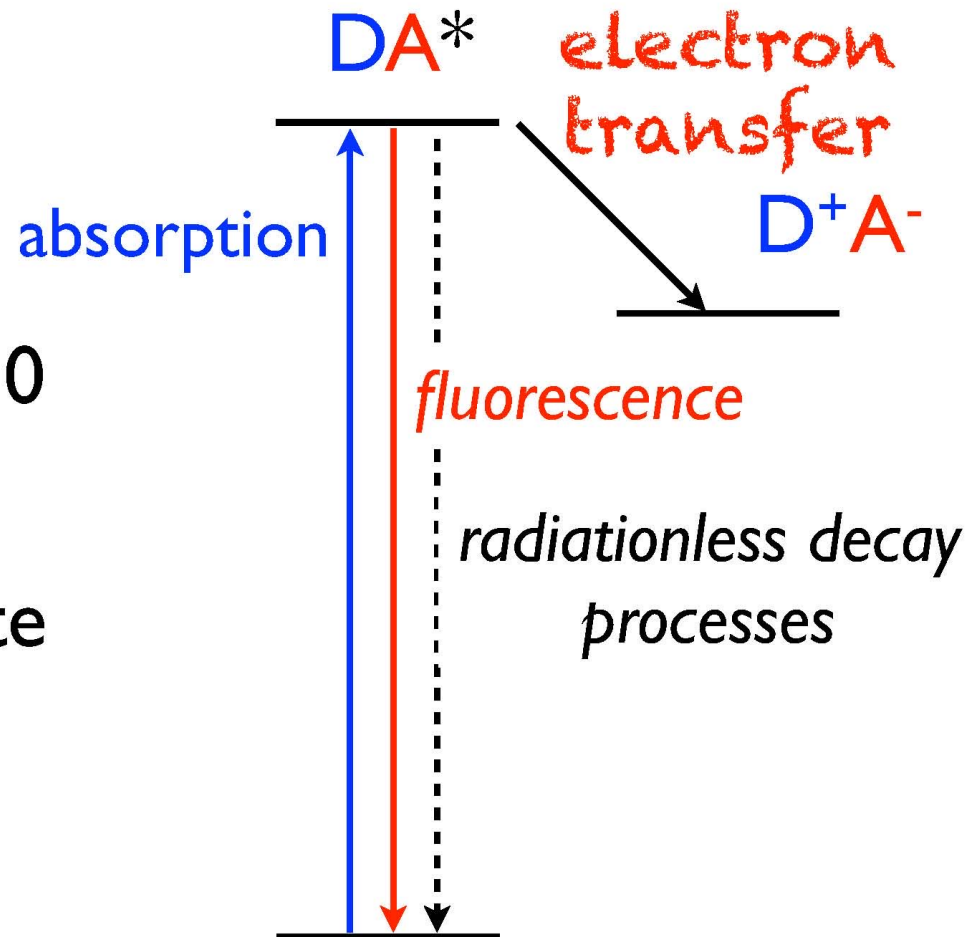



# requirements for charge separation

- there should be a *thermodynamic driving force*  $\Delta G < 0$
- *rate should be high enough to compete with excited state deactivation*

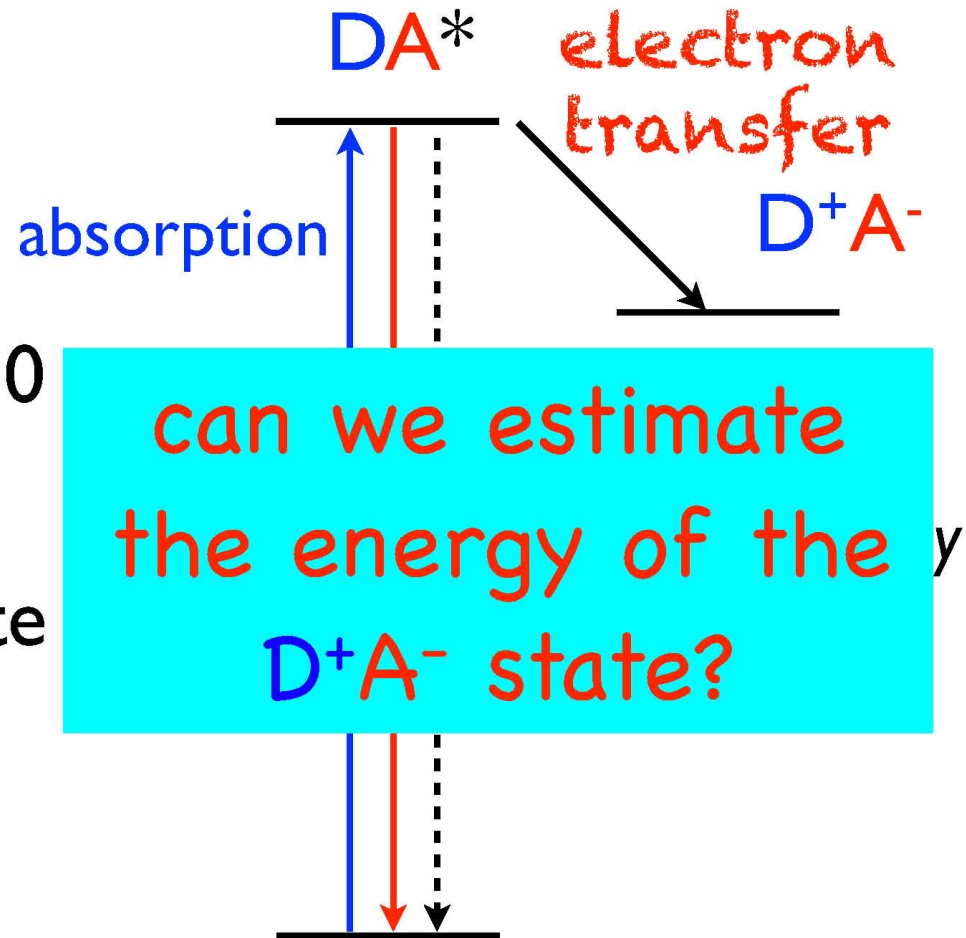

# relative energies of CS-states

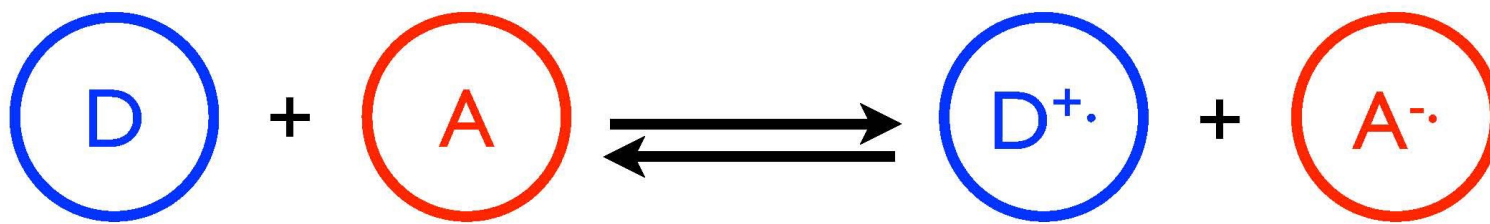

*Two neutral fragments*

*Two (radical) ions*

- simple energy estimation requires:
  - *Redox potentials*
  - *Solvation energies*
  - *Coulomb interaction*



# Electron Addition and Removal is Easier in the Excited State than in the Ground State

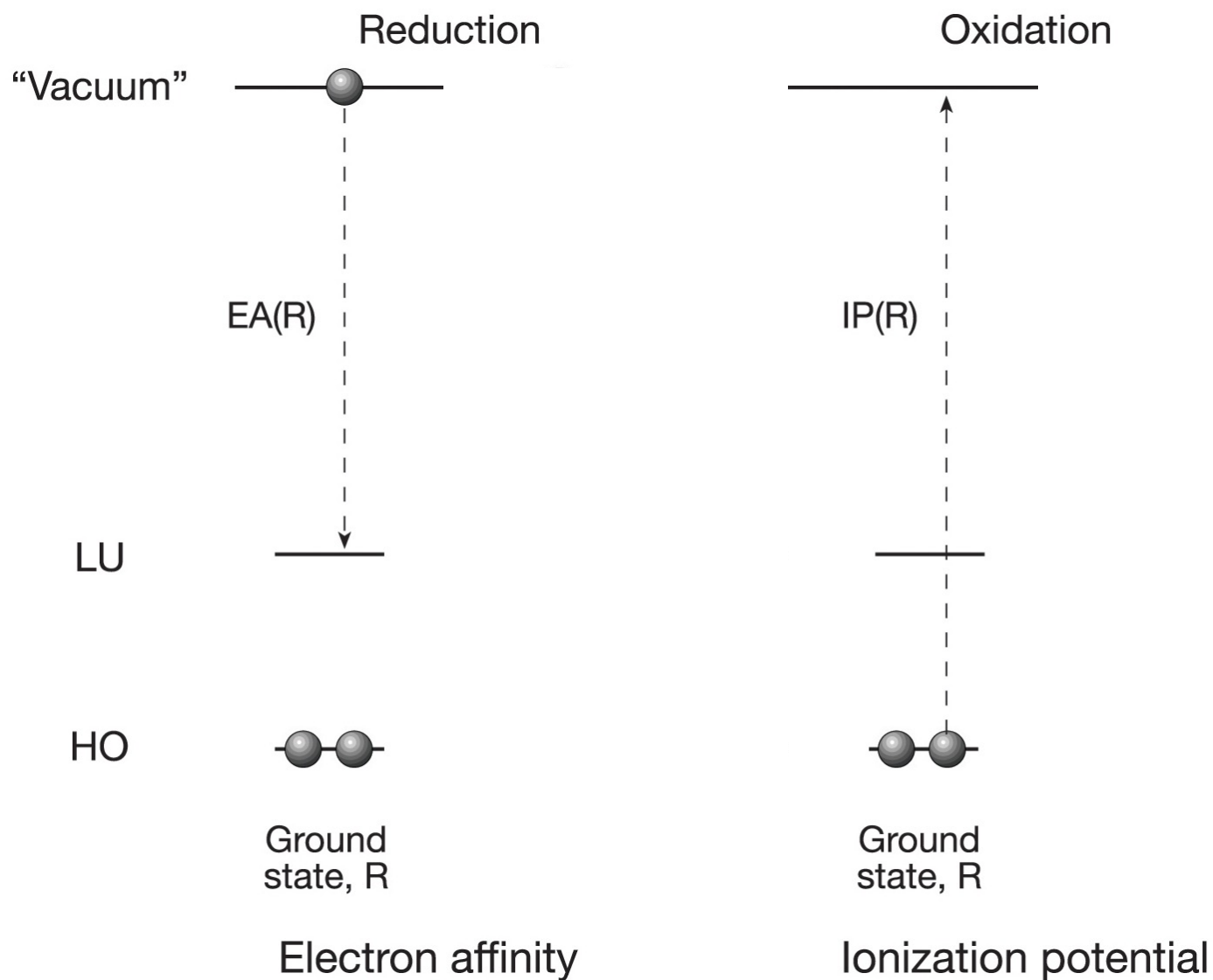

## Remember

**Excited states of diamagnetic molecules with closed shell ground states are always better oxidizing and reducing agents than their corresponding ground states**

**Ground state  
(gas phase)**

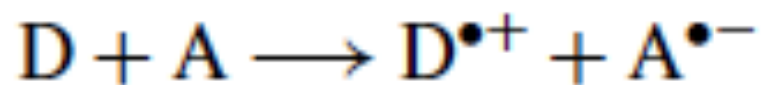

$$\Delta G_{et} = (IP)D - (EA)A$$

**Excited state  
(gas phase)**

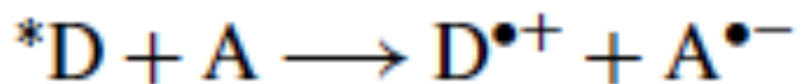

$$^*\Delta G = (IP)_D - (EA)A - E^*D$$

**Excited state  
In solution**

$$\Delta G_{et} = E_{1/2}^{ox}(D) - E_{1/2}^{red}(A) - E_{exc}(A) + \Delta E_{Coulombic}$$

**Rehm-Weller Equation**

# Gas Phase to Solution

The free energy of electron transfer processes in solution can be estimated by two different approaches:

- The value of  $\Delta G$  for the gas phase reaction is calculated using IP and EA and then corrected to take into account the solvation energies for all the participants (i.e. ,  $^*D$ ,  $^*A$ ,  $D^+$  and  $A^-$  in the electron transfer reaction.
- The electrochemical potentials for the oxidations  $E^\circ (D^+/D)$  and reductions  $E^\circ (A/A^-)$  in solution are measured and then employed to calculate  $\Delta G$  directly for the solution electron transfer.
- The key electrochemical parameters are more commonly available or can be determined using standard electrochemical techniques, such as cyclic voltammetry; as a result, the second approach is most commonly used.



# redox potentials



$$\Delta G_{redox} = e \left( E_{red}^{D^+/D} - E_{red}^{A/A^-} \right)$$

- a good **Donor** has a *low oxidation potential*
- a good **Acceptor** has a LOW *reduction potential*
- *in the ground state*  $\Delta G_{redox} > 0$

# Caution

## Be careful about the sign

It is very important to note that by convention in electrochemistry, *both*  $E^\circ$  (D/D<sup>•+</sup>) and  $E^\circ$  (A/A<sup>•-</sup>) are expressed as reductions (D<sup>•+</sup>/D and A/A<sup>•-</sup>). Both reactions are expressed as  $A + e \rightarrow A^{\bullet-}$  and  $D^{\bullet+} + e \rightarrow D$ . Because of this convention, one must pay careful attention to the signs of  $E^\circ$  (D<sup>•+</sup>/D) and  $E^\circ$  (A/A<sup>•-</sup>) when computing the overall value of  $\Delta G$ .

## Be careful about the reference electrode

Another important point in using electrochemical data is that one must employ the standard electrode to which the values of  $E^\circ$  (D<sup>+</sup>/D) and  $E^\circ$  (A/A<sup>-</sup>) refer. Both the standard hydrogen electrode and the standard calomel electrode and silver electrode are commonly used as standards. So, care must be taken to know which is being used and not to mix data from the two standards unless appropriate corrections are made.

# driving force for charge separation

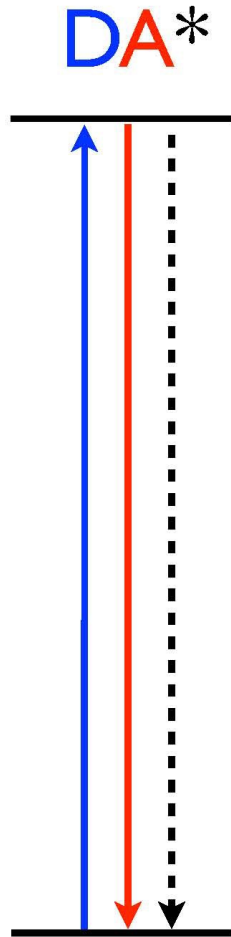

- if the redox potentials are measured in the solvent of interest and the ions are fully separated:

$$\Delta G_{cs} = e \left( E_{red}^{D^+/D} - E_{red}^{A/A^-} \right) - E_{exc}$$

- if not, **correct** for electrostatic interaction and solvation

$$\begin{aligned} \text{Coulombic term} &= N_A \frac{e^2}{4\pi\epsilon_0\epsilon r} \\ &= \frac{3315}{\epsilon r} \text{ (in kcal/mol within \AA)} \end{aligned}$$

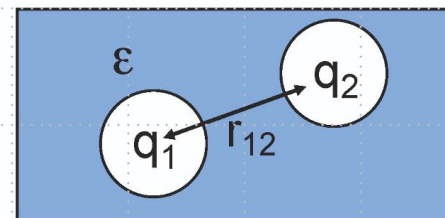

- Coulomb's Law

$$E_{Coul} \sim \frac{q_1 q_2}{\epsilon r_{12}}$$

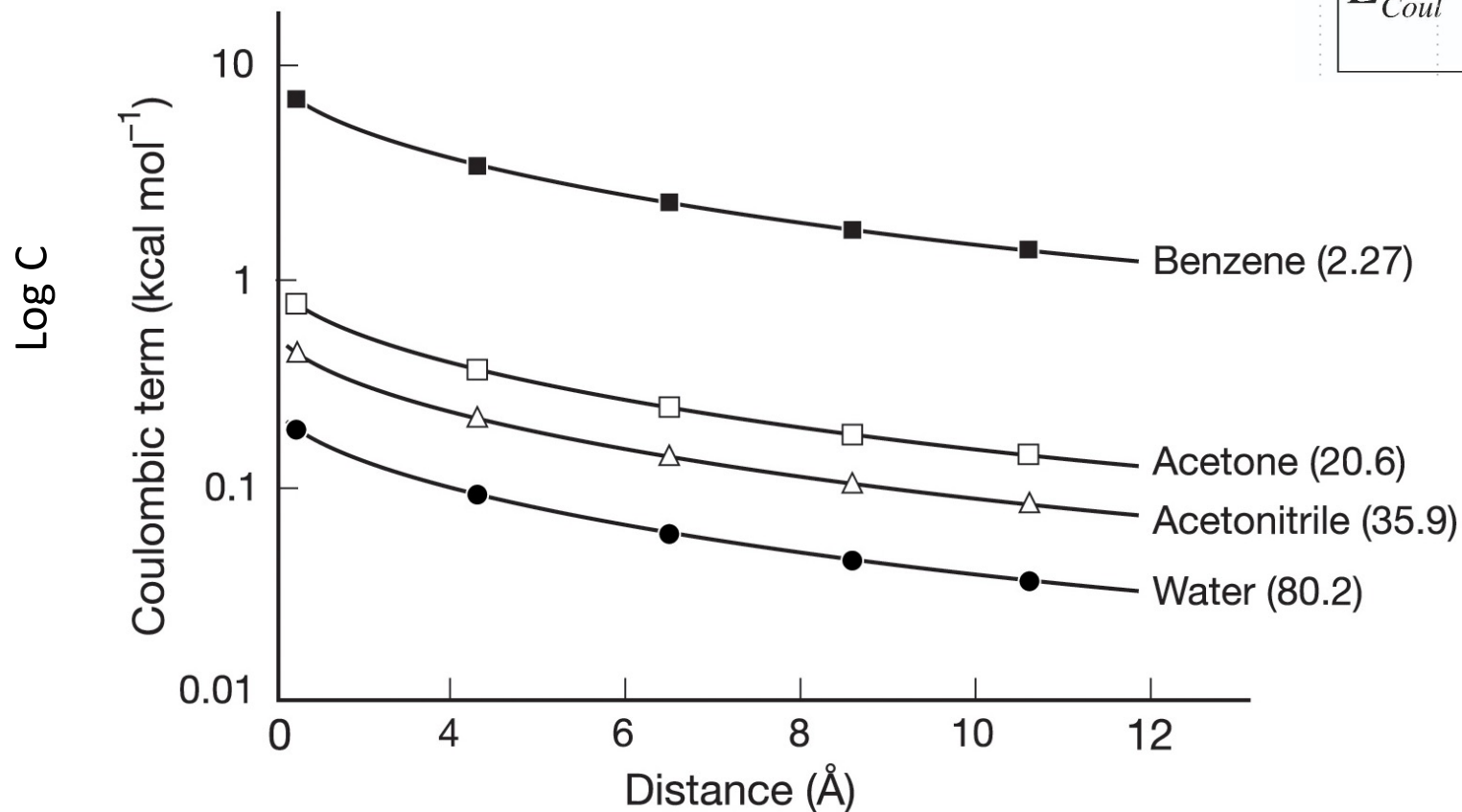



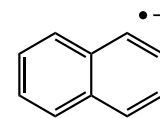
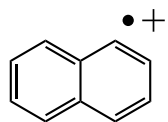

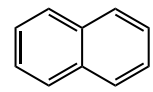
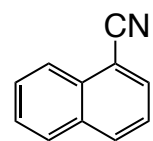
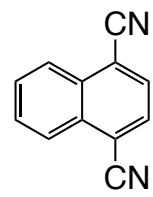
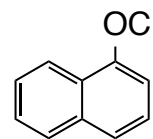
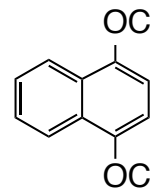
	$E_{\text{ox}}$	$E_{\text{red}}$
	1.84 V	-2.5 V
	--	-1.98 V
	--	-1.28 V
	1.38 V	--
	1.10 V	--

$$\Delta G_{et} = E_{1/2}^{ox}(D) - E_{1/2}^{red}(A) - E_*(A) + \Delta E_{Coulombic}$$

# Resource for Electrochemical Redox Potentials

Table 7b-3 Halfwave Redox Potentials of Aromatic Hydrocarbons.

No.	Compound	$E_{1/2}(X^+/X)$ (V vs. SCE) MeCN	Ref	$E_{1/2}(X/X^-)$ (V vs. SCE) DMF	Ref
1	Acenaphthene	+1.21	[6301]	-2.67	[7001]
2	Acetylene, diphenyl-	-		-2.11	[7701]
3	Anthracene	+1.09	[6301]	-1.95	[7701]
4	Anthracene, 9,10-bis(phenylethynyl)-	+1.165	[6701]	-1.29	[6701]
5	Anthracene, 9,10-dimethyl-	+0.95	[6401]	-	
6	Anthracene, 9,10-diphenyl-	+1.22	[7701]	-1.94	[7701]
7	Anthracene, 9-methyl-	+0.96	[6301]	-1.97 <sup>a</sup>	[6201]
8	Anthracene, 9-phenyl-	-		-1.86	[7001]
9	Azulene	+0.71	[6301]	-1.65 <sup>a</sup>	[6201]
10	Benz[ <i>a</i> ]anthracene	+1.18	[6301]	-	

Table 7b-7 Halfwave Redox Potentials of Nitriles.

No.	Compound	$E_{1/2}(A/A^-)$ (V vs. Ag electrode) DMF <sup>a</sup>	$E_{1/2}(A/A^-)$ (V vs. SCE) MeCN
1	Anthracene, 9-cyano-	-	-1.58 <sup>b</sup>
2	Anthracene, 9,10-dicyano-	-	-0.98 <sup>b</sup>
3	Benzene, 1-cyano-3,5-dinitro-	-0.96	-
4	Benzene, 1-cyano-4-nitro-	-1.25	-
5	Benzene, 1,2-dicyano-	-2.12	-

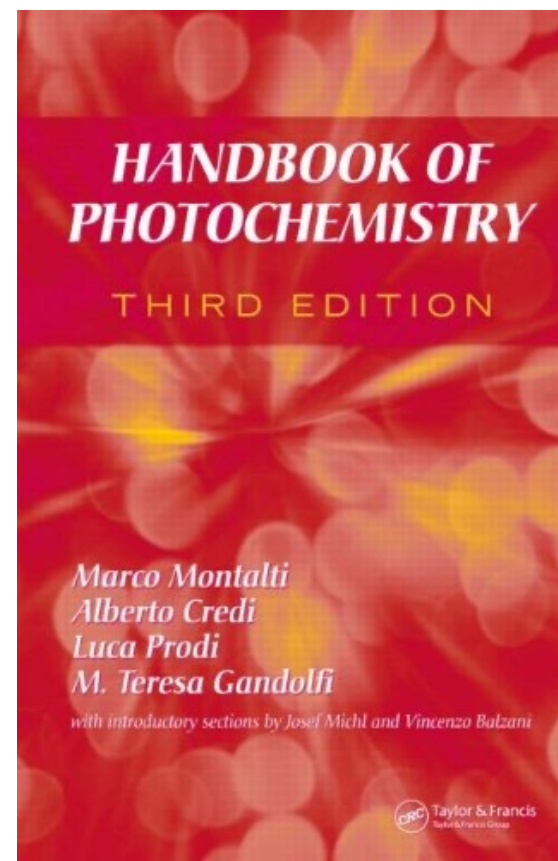

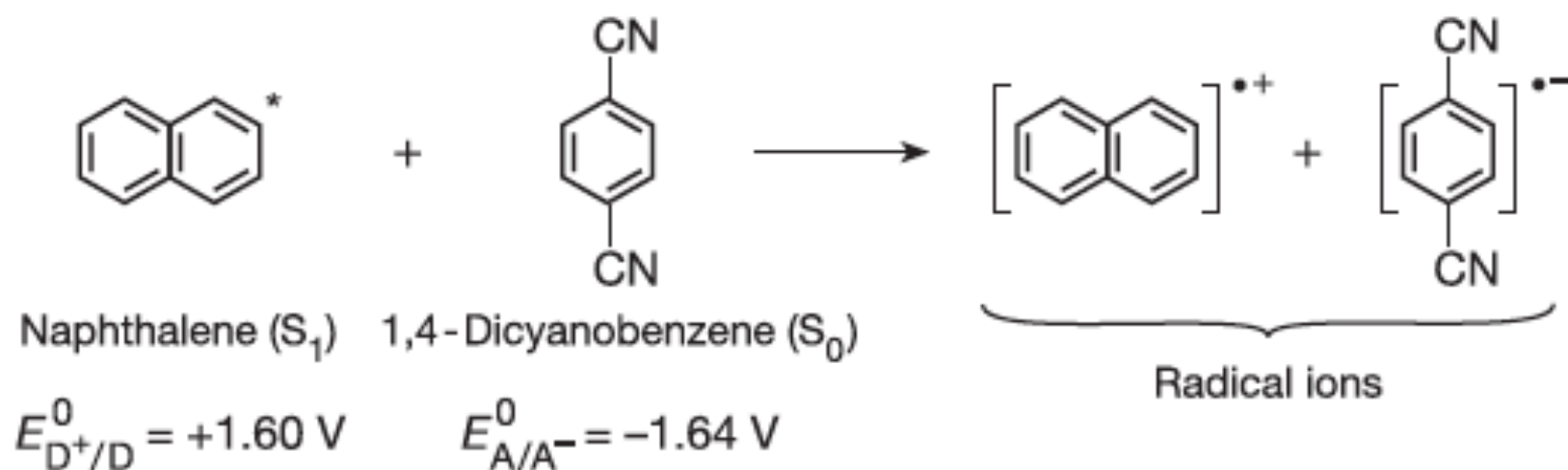
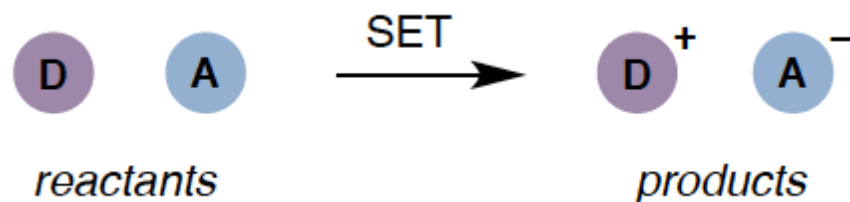

$$E(S_1) = 3.94 \text{ eV} = 90.9 \text{ kcal mol}^{-1}$$

$$\Delta G^\circ = \mathcal{F}E_{D^+/D}^0 - \mathcal{F}E_{A/A^-}^0 - E_D^* - 0.2$$

$$\Delta G^\circ = 36.9 - (-37.8) - 90.9 - 0.2 = -16.4 \text{ kcal mol}^{-1}$$

$$k \text{ (electron transfer)} = 1.8 \times 10^{10} \text{ M}^{-1} \text{ s}^{-1}$$

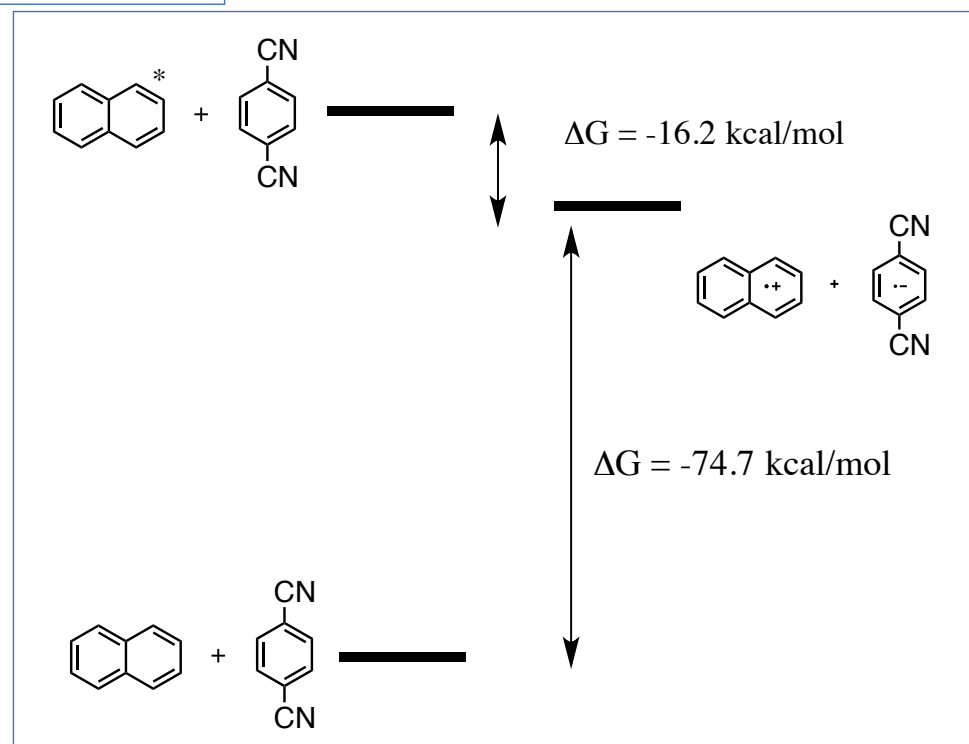
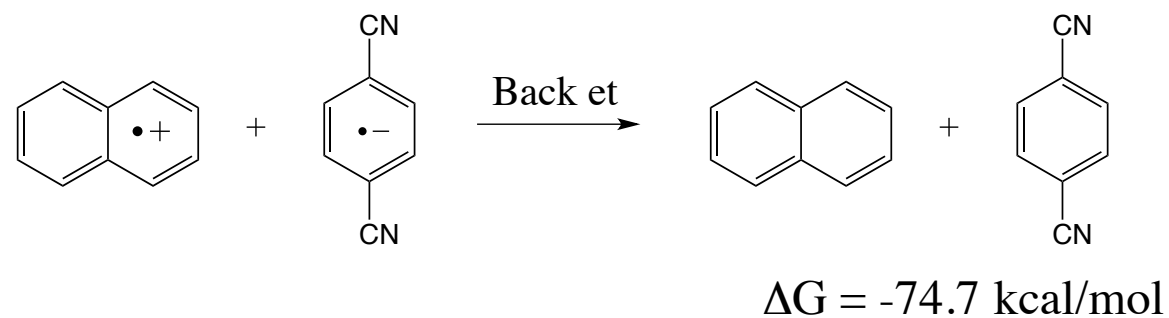
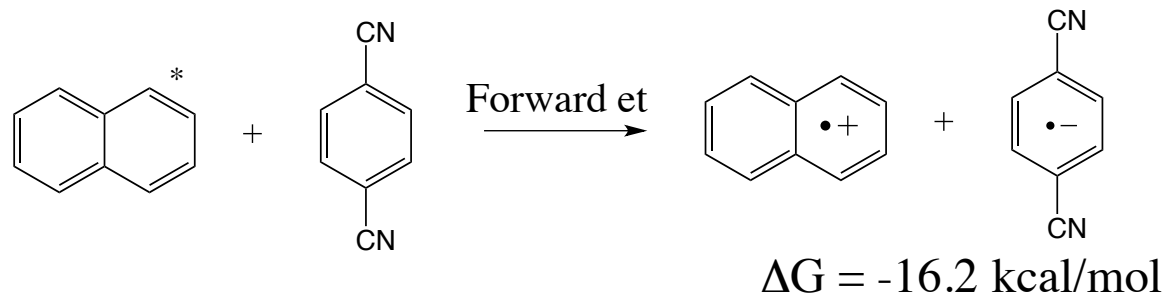



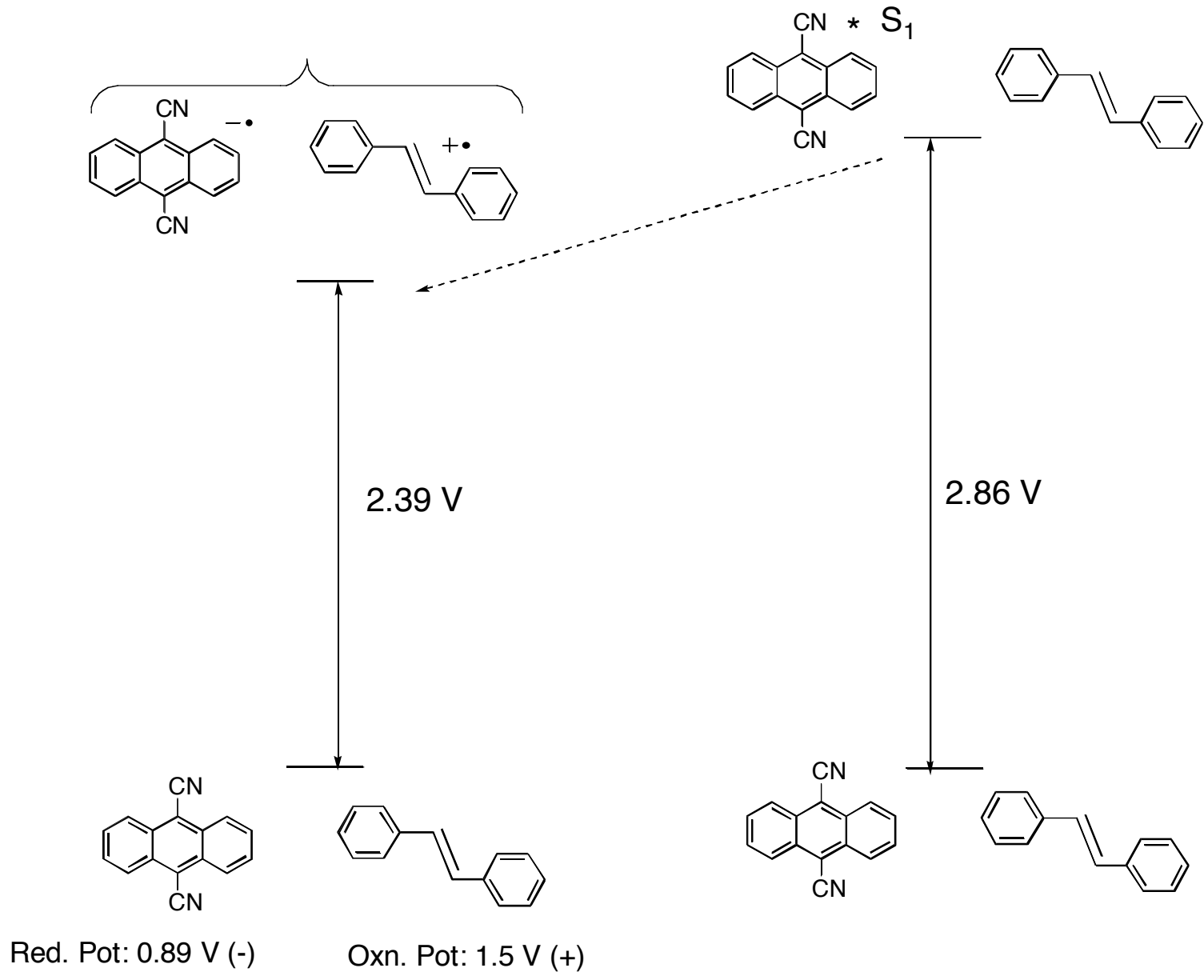

Free energy of activation expressed in terms of the free energy of reaction ( $\Delta G$ ) and free energy of activation ( $\Delta G^\ddagger$ )

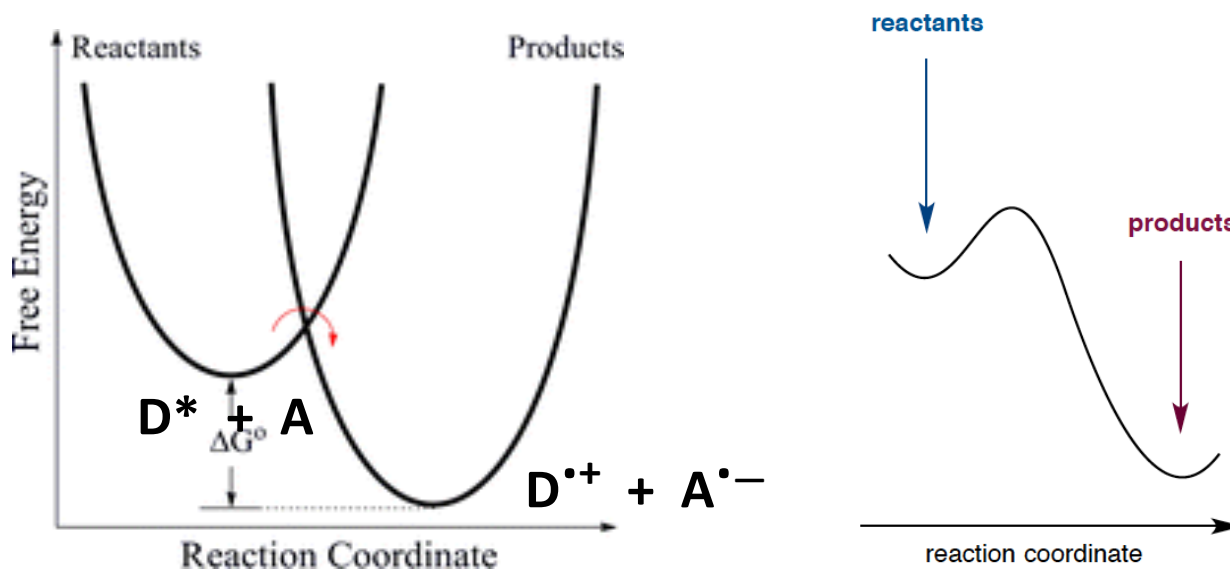

$$k_{et} = k_0 \exp \left( -\frac{\Delta G_{et}^\ddagger}{RT} \right)$$

$$\Delta G_{et} = E_{1/2}^{ox}(D) - E_{1/2}^{red}(A) - E_*(A) + \Delta E_{Coulombic}$$

**Rehm-Weller Equation**

# Dependence of the electron transfer rate on the driving force $\Delta G^0$ and the free energy of activation $\Delta G^\ddagger$

D. Rehm and A. Weller, *Isr. J. Chem.*, 8, 259, 1970

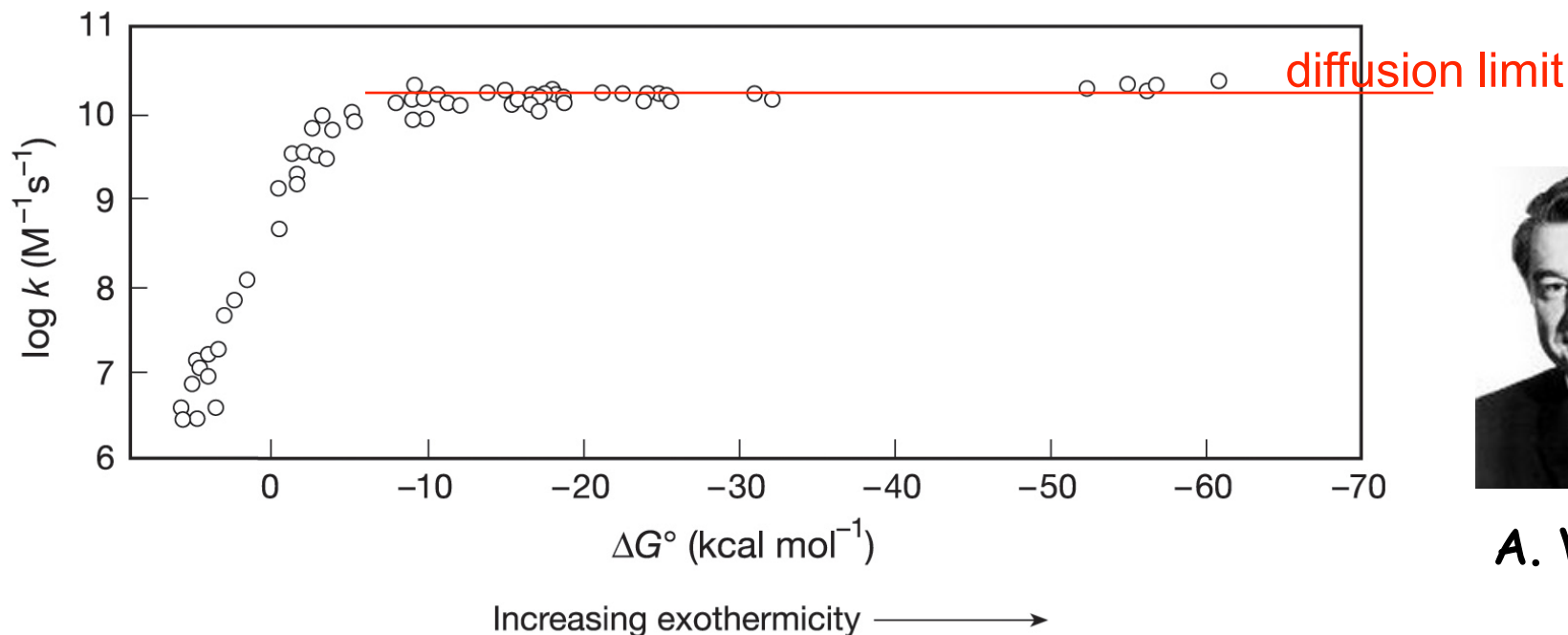

# More Rehm-Weller Plots

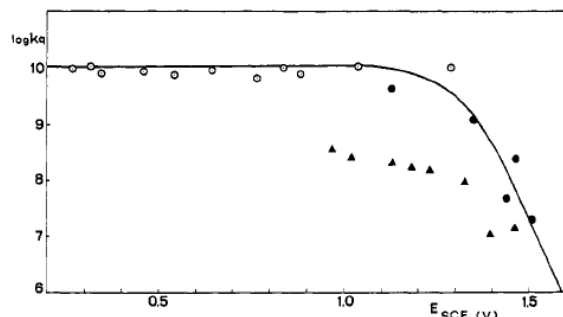

Figure 2. Plot of the logarithm of the rate constant vs.  $E_{1/2}(Q/Q^+)$  for the quenching of  $\text{Cr}(\text{bpy})_3^{3+}$  by aromatic amines (○), methoxybenzenes (●), and aliphatic amines (▲).

V. Balzani, et. al., *JACS*,  
100, 7219, 1978

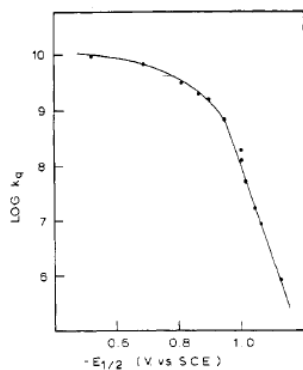

Figure 1. Plot of  $\log k_q^{\text{obsd}}$  vs. quencher reduction potential,  $E_{1/2}[Q/Q^-]$ .

C. R. Brock, T. J. Myers and  
D. G. Whitten, et. al.,  
*JACS*, 97, 2909, 1975

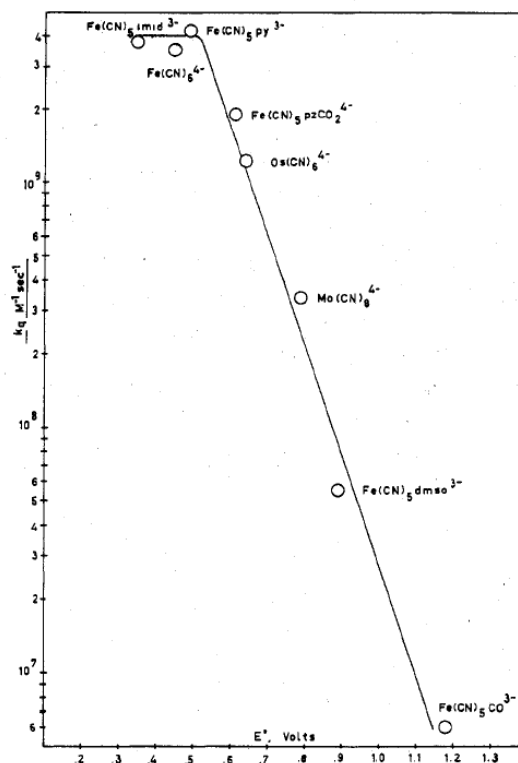

Figure 4. Dependence of quenching rate constant on quencher redox potential for several metalocyanide complexes.

H. Toma and C. Creutz,  
*Inorganic Chemistry*,  
16, 545, 1977

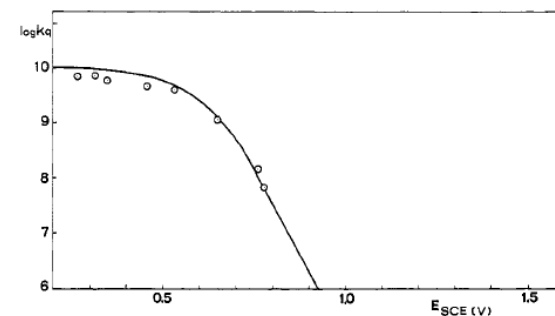

Figure 3. Plot of the logarithm of the rate constant vs.  $E_{1/2}(Q/Q^+)$  for the quenching of  $\text{Ru}(\text{bpy})_3^{2+}$  by aromatic amines.

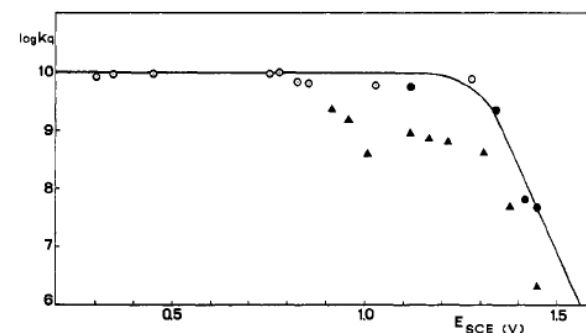

Figure 4. Plot of the logarithm of the rate constant vs.  $E_{1/2}(Q/Q^+)$  for the quenching of  $\text{Ir}(\text{Me}_2\text{phen})_2\text{Cl}_2^+$  by aromatic amines (○), methoxybenzenes (●), and aliphatic amines (▲).



# Mechanism of eT: Libby Model

W. F. Libby, *J. Phys. Chem.*, 56, 863, 1952; *J. Chem. Phys.*, 38, 420, 1963;



Willard F. Libby

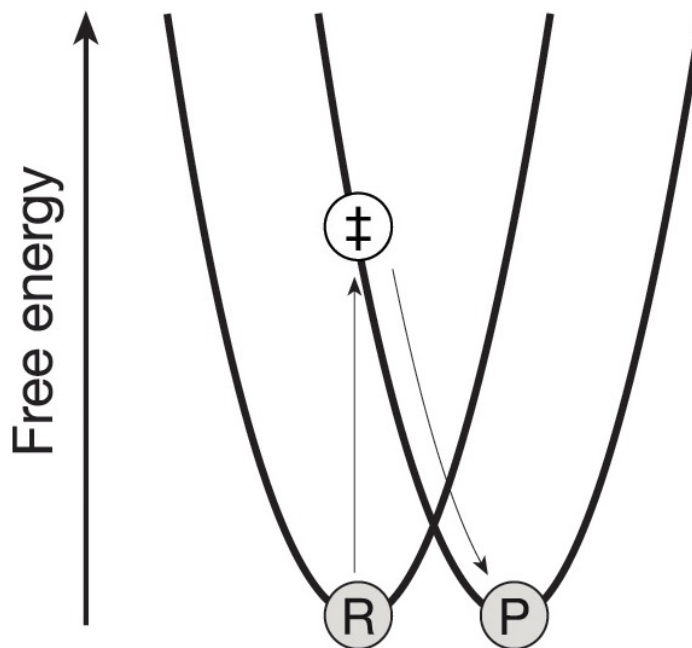

The Nobel Prize in Chemistry 1960 was awarded to Willard F. Libby "for his method to use carbon-14 for age determination in archaeology, geology, geophysics, and other branches of science".

# Libby Model

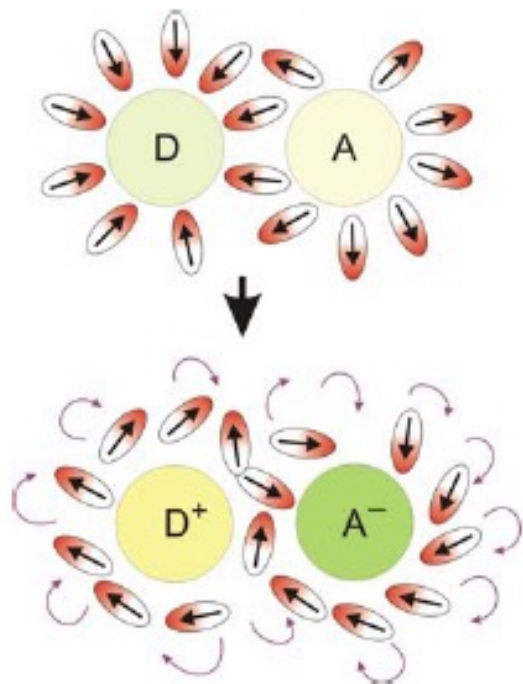
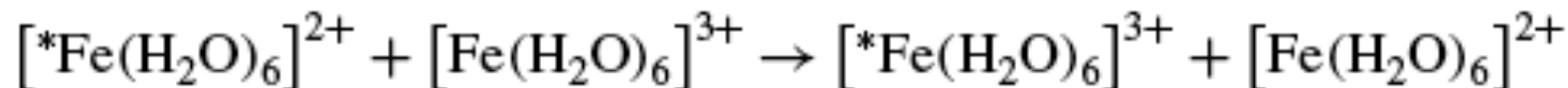
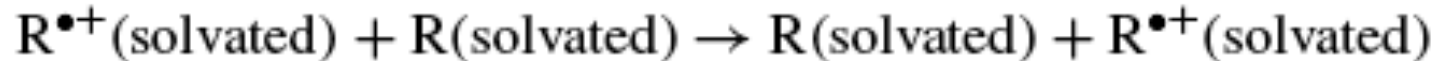

The electron jump from R ( $^*\text{Fe}^{2+}$ ) to  $R^{\bullet+}$  ( $\text{Fe}^{3+}$ ) is analogous to the electron jump from a HO to a LU that leads to formation of an electronically excited state.

The electron jump is expected to occur "vertically" and to follow the Franck-Condon principle; the geometry of the products formed by an electron transfer would be the same as the geometry of the reactants.

Two types of reorganization occur after the et: (1) an electronic and vibrational reorganization, termed *internal molecular reorganization*; and (2) a solvent reorganization associated with the solvent reorientation to accommodate the new electronic structures termed *external solvent reorganization*.

# Libby Model

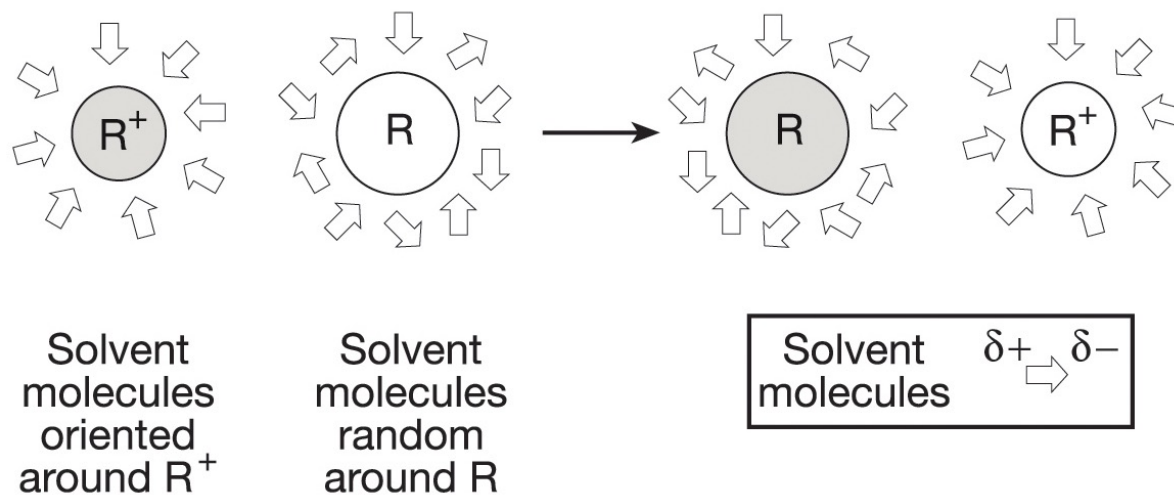
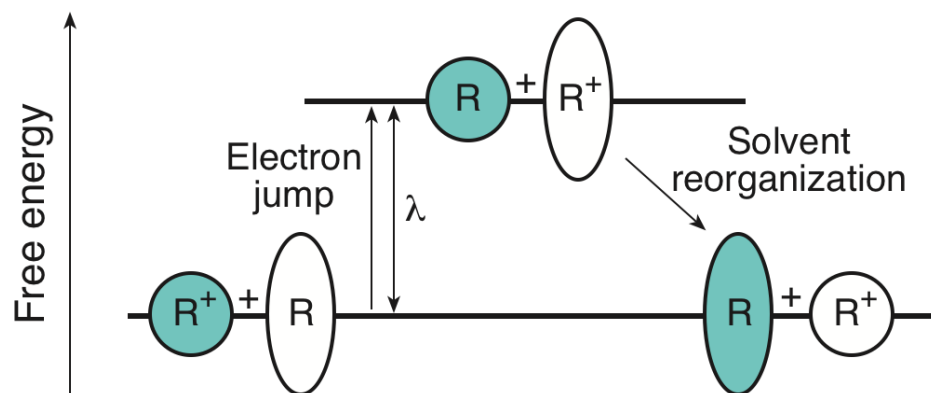
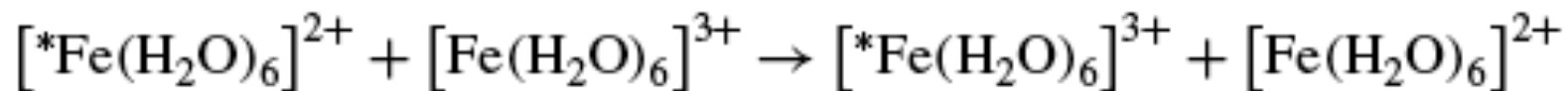
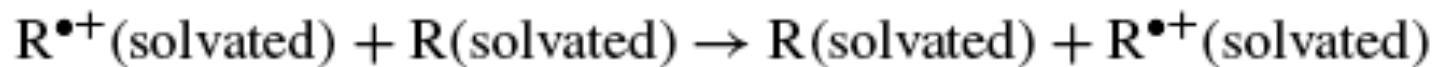

# Evolution of Marcus model

R. A. Marcus, *J. Chem. Phys.*, 24, 966, 1956.

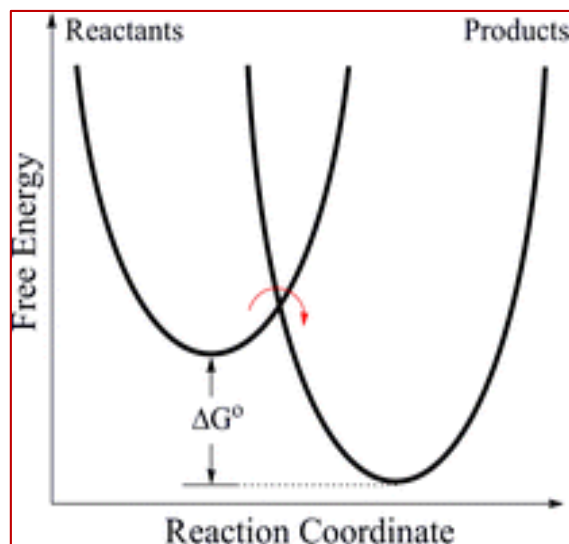

Weller Model

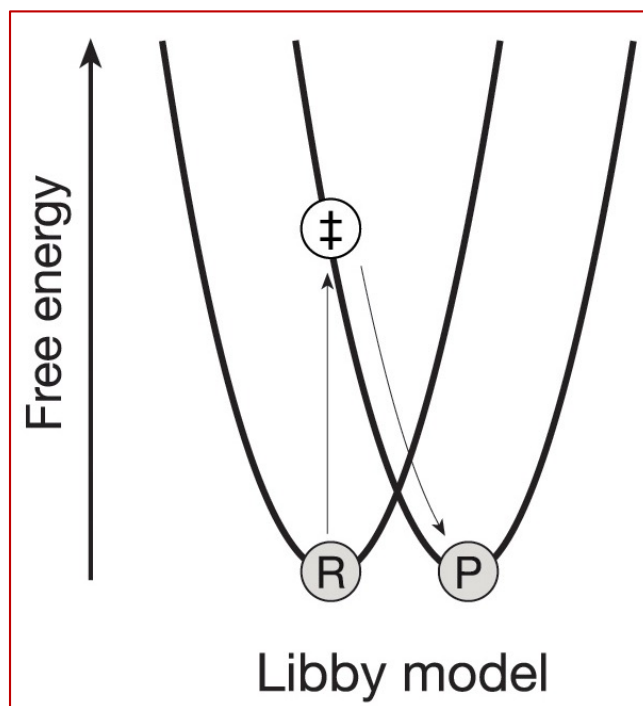

Libby model

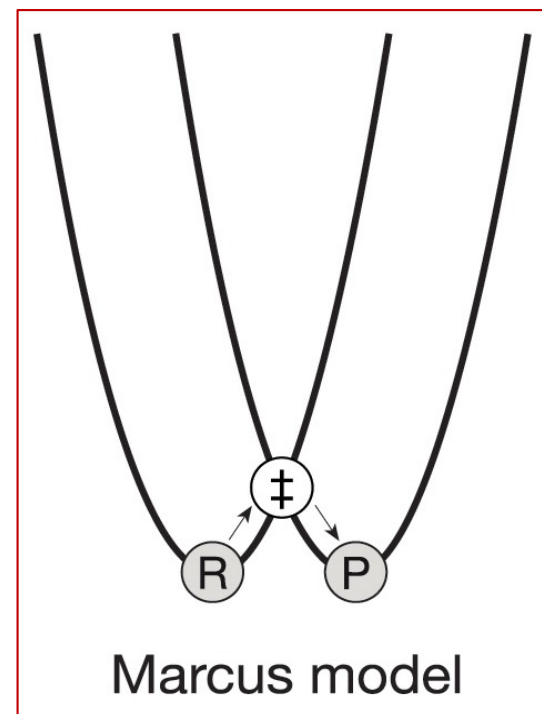

Marcus model

$$k_{\text{et}} = A \exp^{-(\Delta G^\ddagger/RT)}$$

# The Marcus model

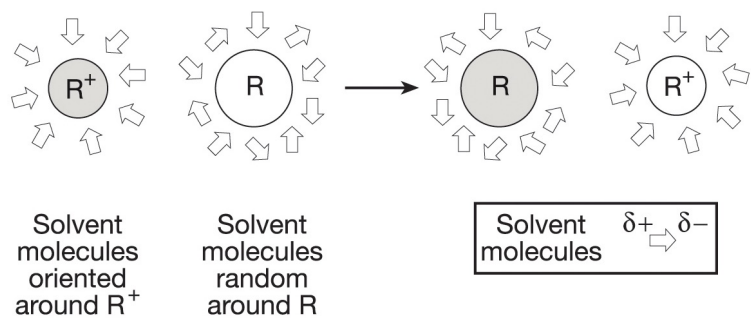
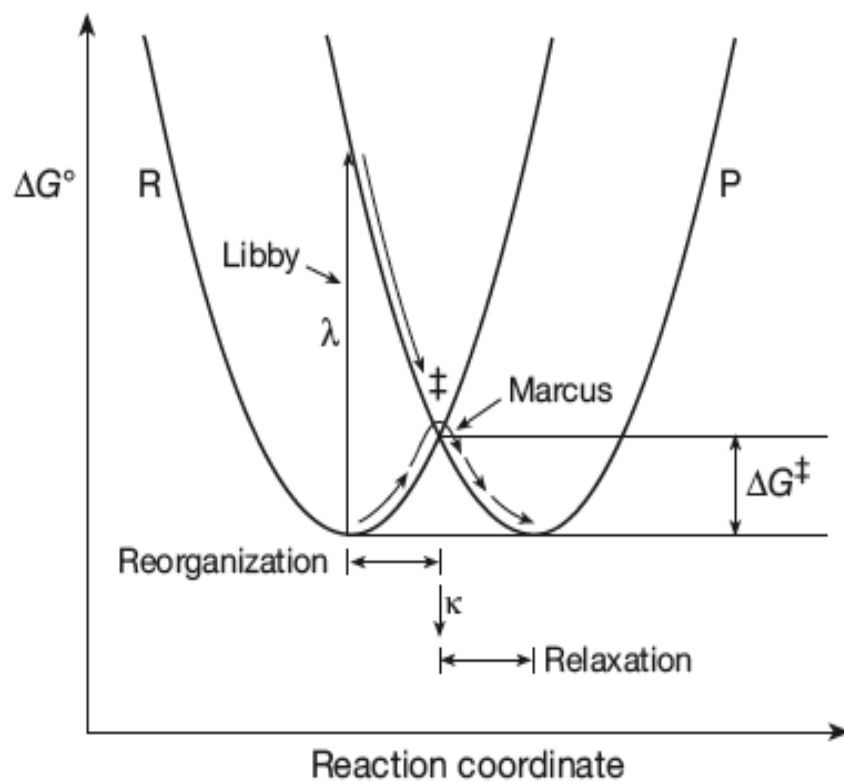

R. A. Marcus, *J. Chem. Phys.*, 24, 966, 1956.

R. A. Marcus and N. Sutin, *Biochemica et Biophysica Acta*, 811, 265, 1985.

R. A. Marcus, *Electron transfer Reactions in Chemistry: Theory and Experiment*, (Nobel Lecture) *Angew. Chem. Int. Ed.*, 32, 1111, 1993.



R. A. Marcus

Rates are expected:

- ✧ to be slow for weakly exothermic reactions,
- ✧ to increase to a maximum for moderately exothermic reactions, and then
- ✧ to decrease with increasing exothermicity for highly exothermic et reactions.



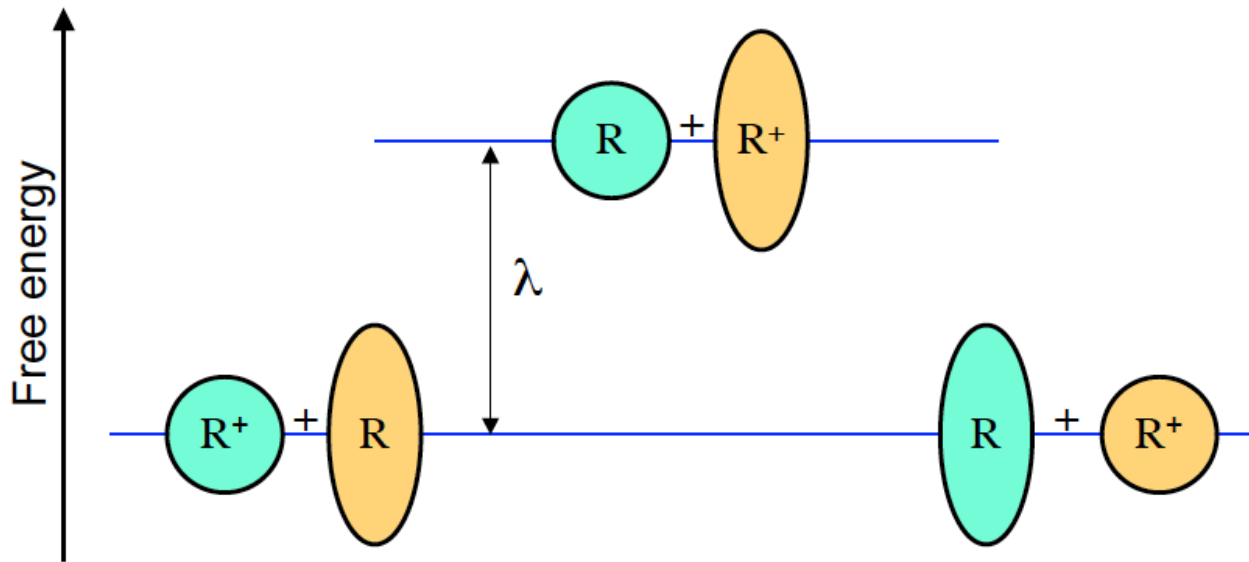

## Libby Model

Electron transfer is a two step process:

- (a) Electron transfer first with no change of nuclear positions (Franck-Condon principle)
- (b) Solvent reorganization

## Marcus Model

The above two step model violates thermodynamic principle of conservation of energy. Electron transfer follows reorganization.

$$k = (A) \exp\left[\frac{-\Delta G_{cs}^\#}{k_B T}\right]$$

**Arrhenius**

$$k_{cs} = \frac{2\pi^{3/2}}{h\sqrt{\lambda k_B T}} (V)^2 \exp\left[\frac{-(\Delta G + \lambda)^2 / 4\lambda}{k_B T}\right]$$

**Classical Marcus**

$$k_{cs} = \frac{2\pi^{3/2}}{h\sqrt{\lambda_s k_B T}} (V)^2 \sum_{m=0}^{\infty} \frac{e^{-S} S^m}{m!} \exp\left[\frac{-(\lambda_s + \Delta G_{cs} + m h \nu_i)^2}{4\lambda_s k_B T}\right]$$

**Semi-Classical Marcus**

# Predictions

The consequences of expressing the free energy of activation in terms of the driving force and  $\lambda$

$$\Delta G^\ddagger = (\Delta G^\circ + \lambda)^2 / 4\lambda$$

1. For an iso-energetic self-exchange reaction one obtains:

**For  $\Delta G^\circ = 0$  one obtains  $\Delta G^\ddagger = \lambda/4$**

**For  $\Delta G^\circ = -\lambda$  one obtains  $\Delta G^\ddagger = 0$**

2. At this stage the reaction becomes barrierless and proceeds at the maximum rate allowed by the pre-exponential factor.

# The re-emergence of the activation barrier ( $\Delta G^\ddagger$ ) at large negative $\Delta G^0$ values

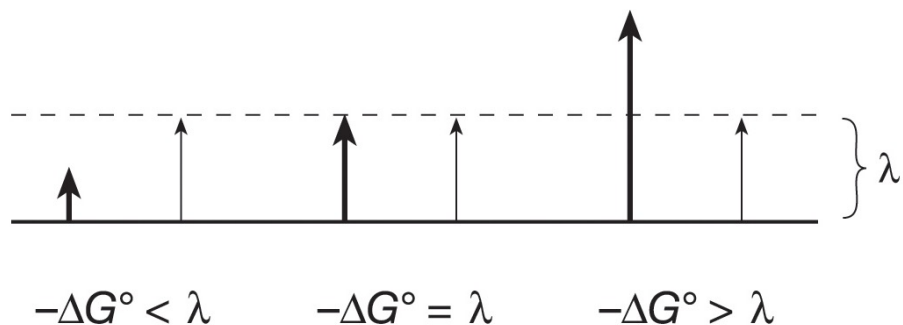

$$k_{\text{et}} = A \exp^{-(\Delta G^\ddagger/RT)}$$

$$\Delta G^\ddagger = (\Delta G^0 + \lambda)^2/4\lambda$$

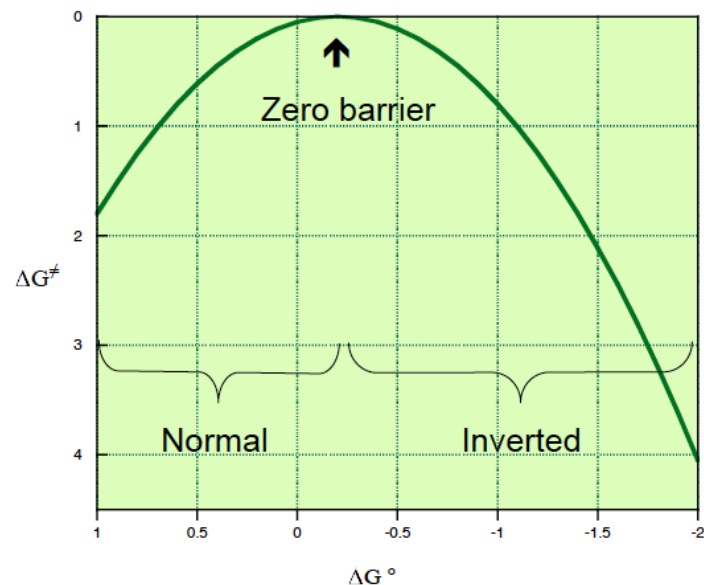
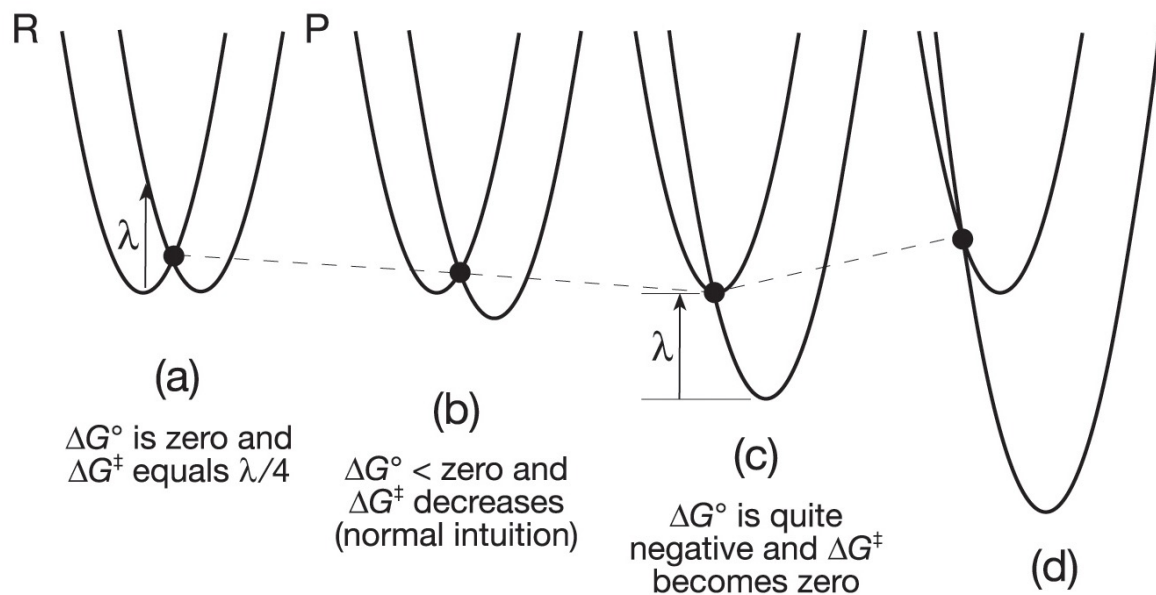

● The dot traces the energy of the transition state as  $\Delta G^0$  becomes more negative

$\Delta G^0$  is even more negative and  $\Delta G^\ddagger$  becomes positive again (!)

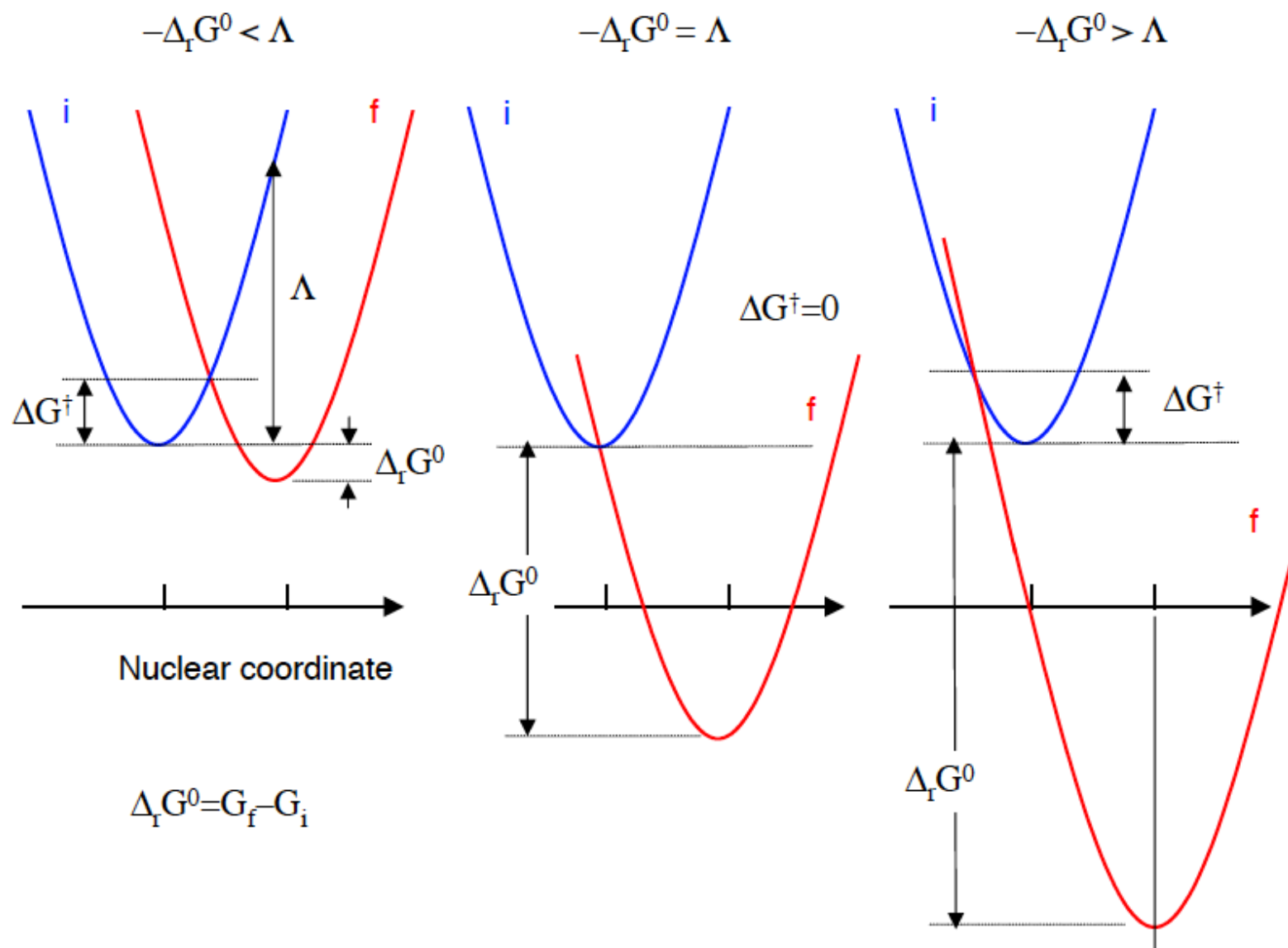

The predicted existence of such an "inverted region" was controversial from the time the theory was proposed in 1956 until experimental evidence of it was found for a set of photoredox reactions (Closs & Miller, 1986).

## Marcus prediction vs Weller's experiments

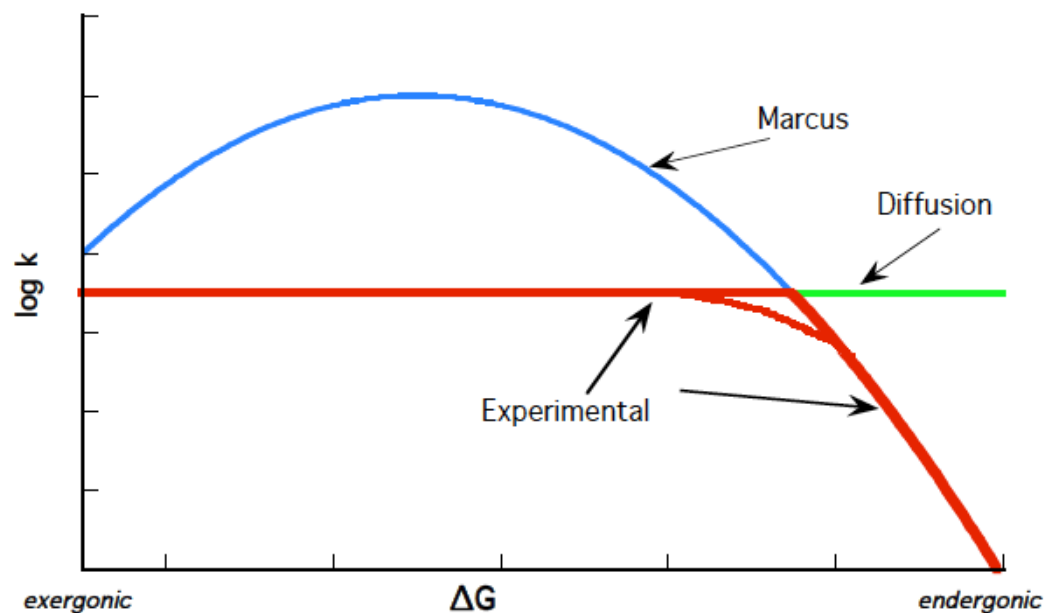

### Electron Transfer Involves Two Steps

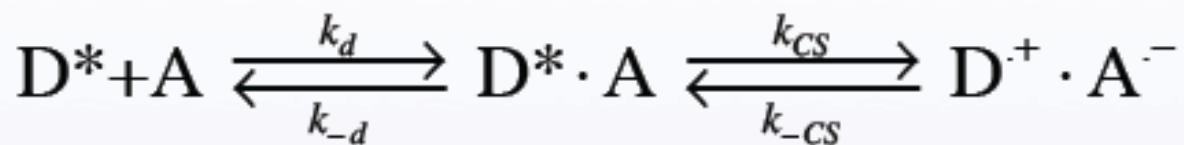

The experimental rate constant is limited by the diffusion rate constant in the solvent, it effectively hides the Marcus inverted region. On the right section of the plot the reaction is endothermic and the prediction of the Marcus equation is followed. The Rehm-Weller equation does not make allowance for an inverted region.



# Experimental conditions to observe the Marcus "inverted region"?

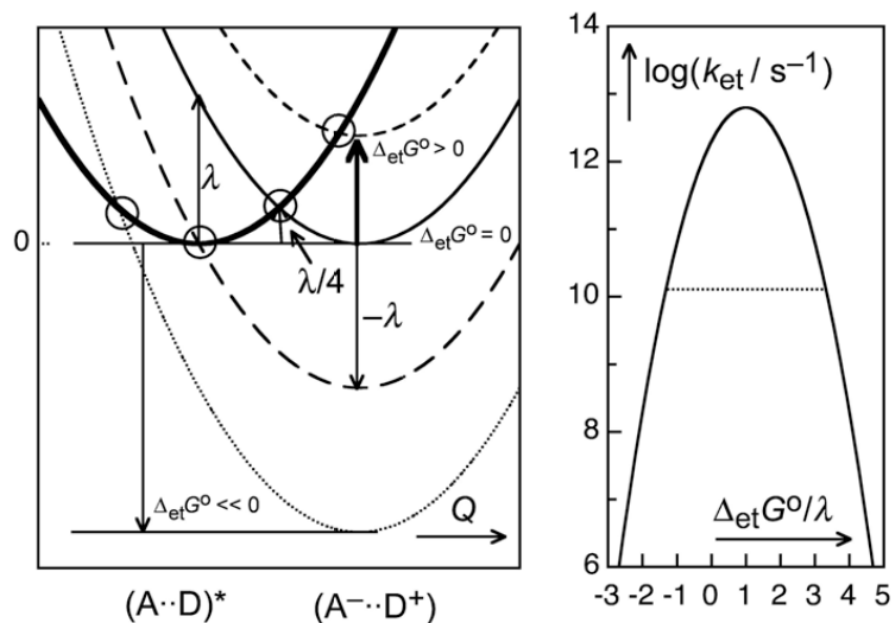

For most donor-acceptor (DA) systems the inverted region is obscured by the diffusion limit. Suppress the need for diffusion.

This can be circumvented by:

- ❖ freezing the donor-acceptor distribution (glassy medium)
- ❖ covalently linking the donor and the acceptor
- ❖ lowering the donor-acceptor interaction (electronic coupling  $V$ ) so that the maximum rate for  $-\Delta G^0 = \lambda$  is lower than the diffusion limit.

## Effect of Free Energy on Rates of Electron Transfer Between Molecules in Glass at 77 ° K

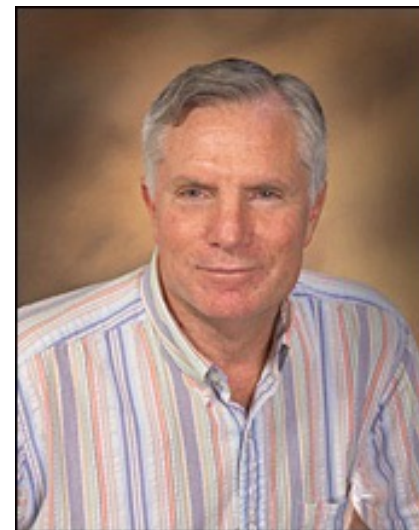
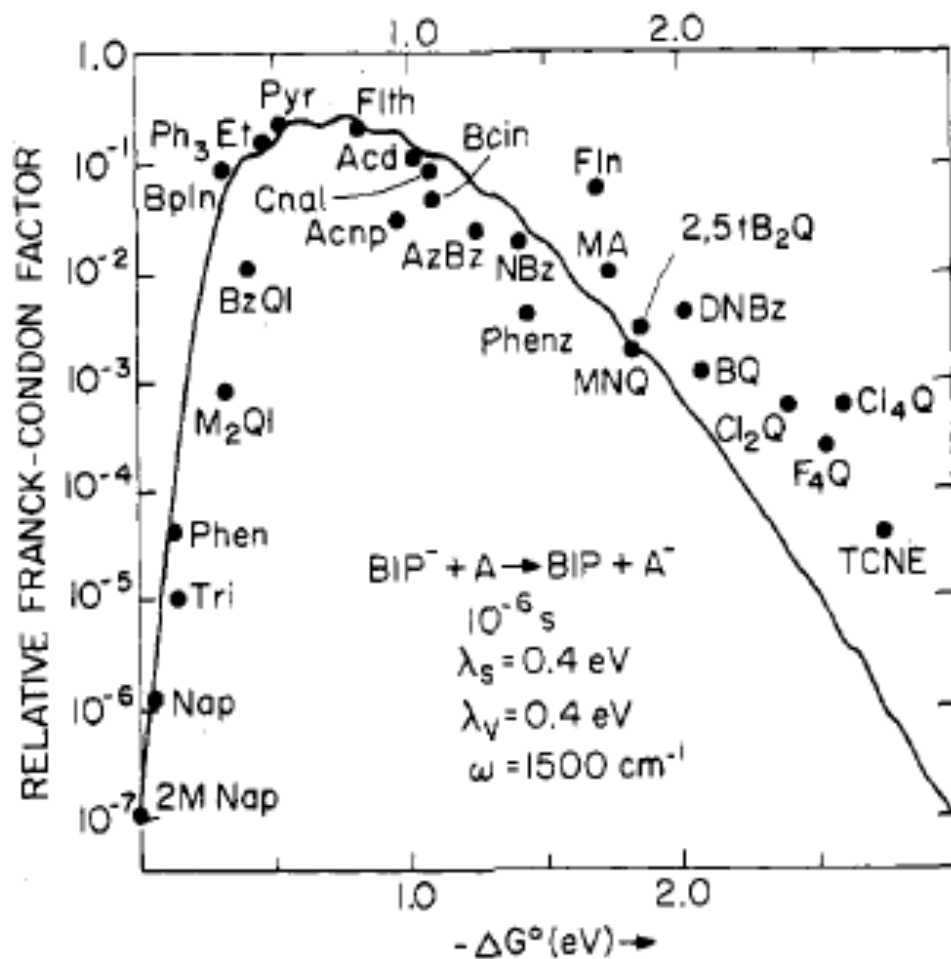

J. R. Miller

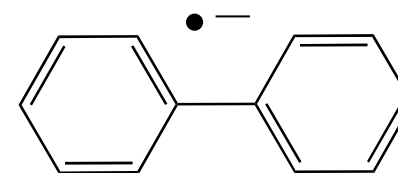

**Figure 7.** Relative rates of ET reactions of the biphenyl anion as a function of exothermicity at  $10^{-6}$  s expressed as relative Franck-Condon factors (see eq 4, 10, 11, and 12). The line was calculated by using eq 4.

J. R. Miller, J. V. Beitz, and R. K. Huddleston, *J. Am. Chem. Soc.*, **106**, 5057, 1984.

■ Pioneering 1984 Study by Miller and Closs Definitively Proved the Existence of the Inverse Region



G. Closs



J. R. Miller

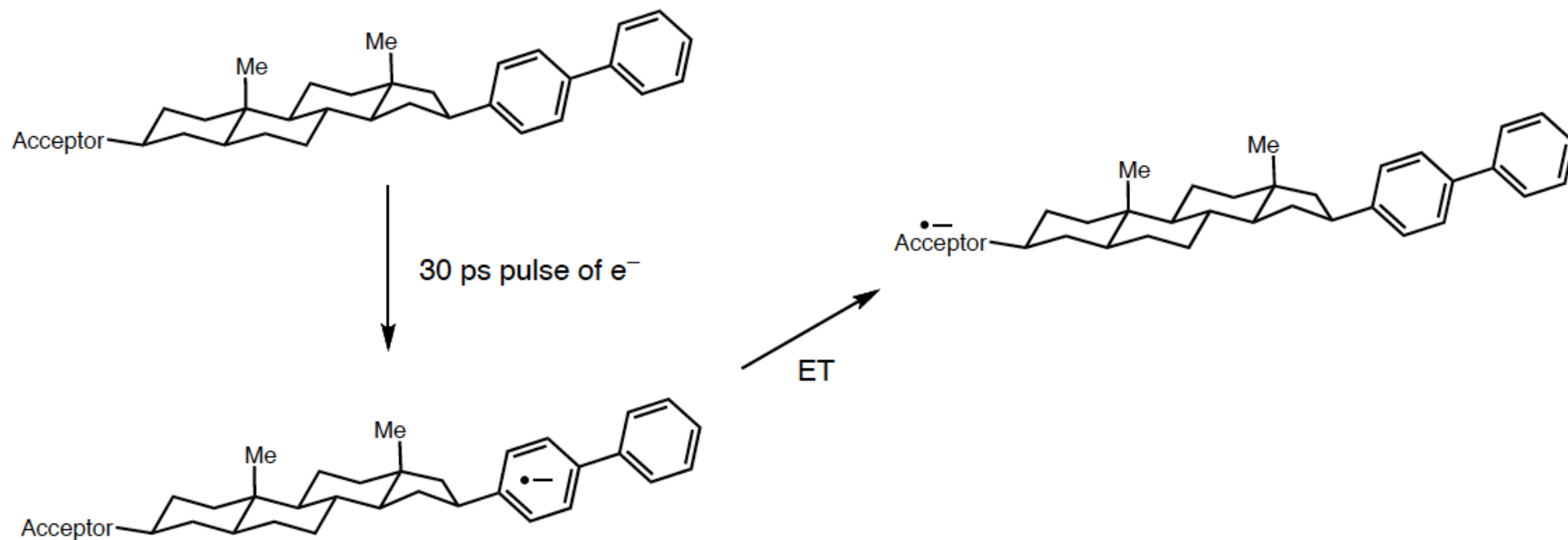

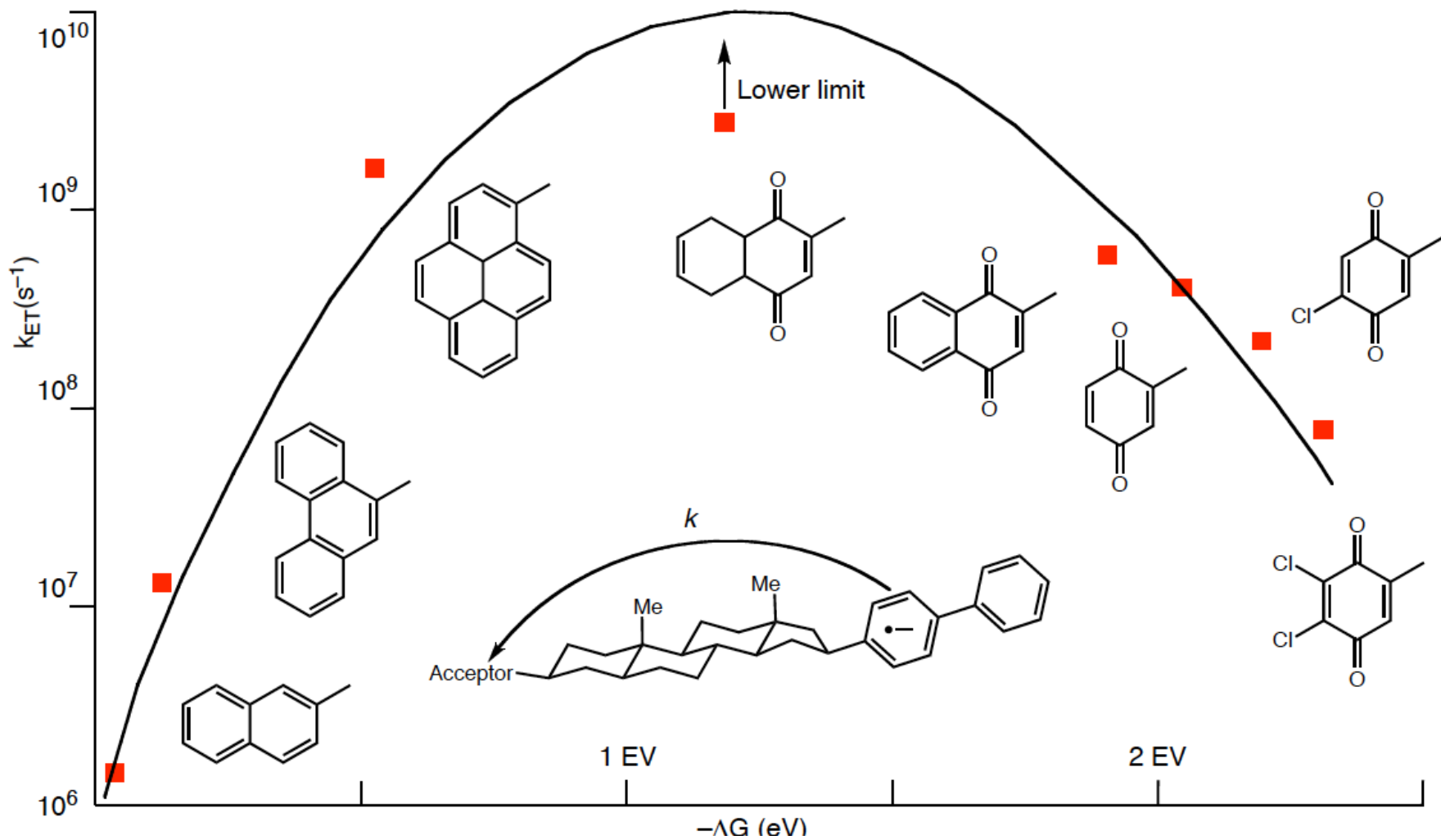

G. Closs and J. R. Miller, *Science*, 240, 440-447 (1988)

J. R. Miller, L. T. Calcaterra and G. L. Closs, *J. Am. Chem. Soc.*, 106, 3047-3049 (1984)

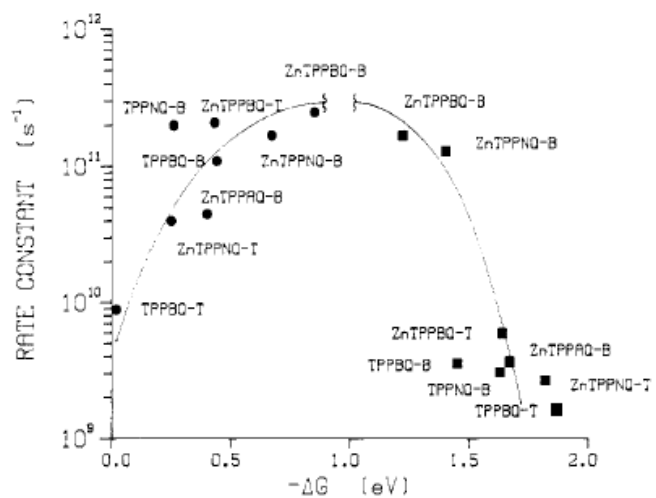

**Figure 2.** Plot of rate constant vs. exothermicity for the reaction  $1^*P-Q \rightarrow P^+ - Q^-$  and for  $P^+ - Q^- \rightarrow P - Q$ , where P = porphyrin and Q = quinone. The B and T after the name of the compounds indicate data obtained in butyronitrile or in toluene, respectively. The maximum uncertainty in any given rate constant is  $\pm 20\%$ .

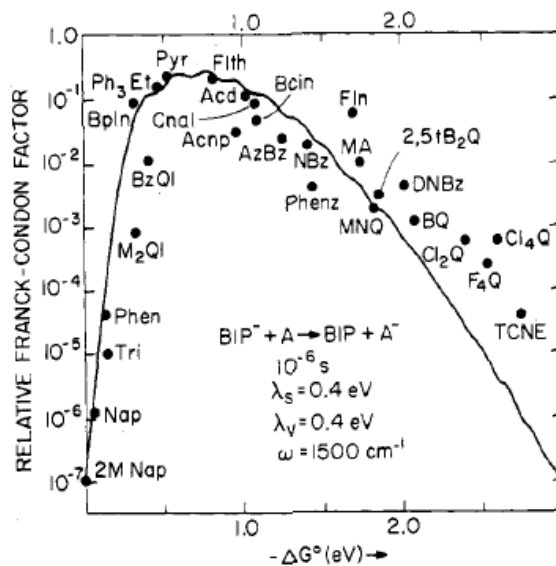

**Figure 8.**  $\Delta G^\circ$  dependence of  $k_b/k_{dis}$  for backward ET between  $Ru-(bpz)_3^+$  and the cation radicals of the aromatic donors. The line is drawn for easy viewing.

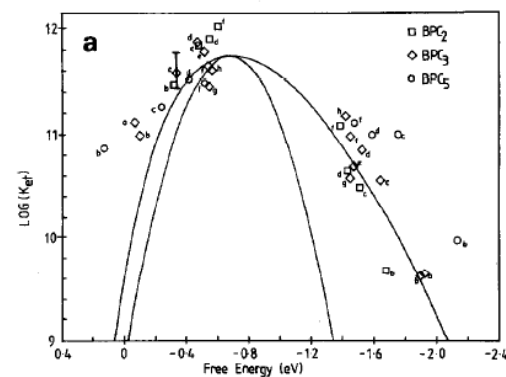

**Fig. 10.** The dependence of the CR rate constant  $k_n$  of geminate ion pairs produced by fluorescence quenching reaction on the free energy gap  $-\Delta G_{ip}^0$  in acetonitrile solution.

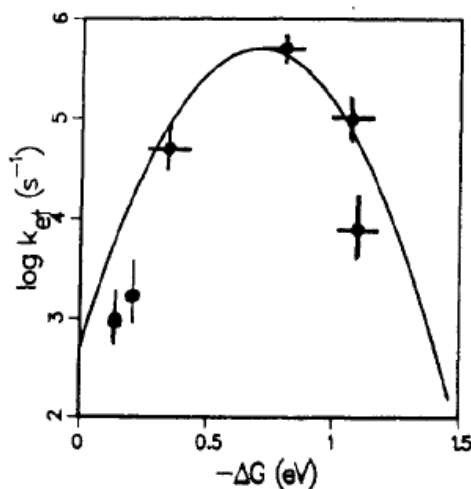

**Figure 8.** Plot of intracomplex electron-transfer rate between cyt c and cyt  $b_3$  as a function of free energy. Solid line is fit to Marcus' theory,  $\lambda = 0.8v$ .

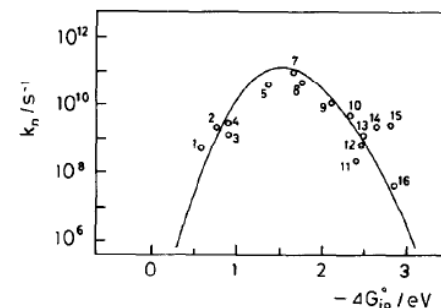
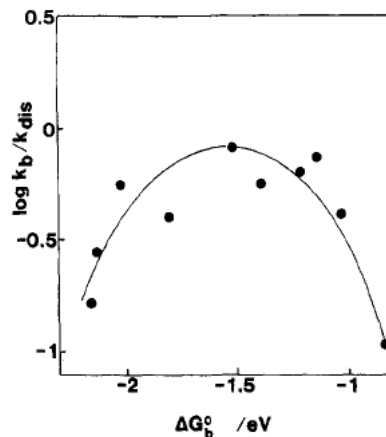



# The Nobel Prize in Chemistry 1992



The Nobel Prize in Chemistry 1992 was awarded to Rudolph A. Marcus "for his contributions to the theory of electron transfer reactions in chemical systems".



# The re-emergence of the activation barrier ( $\Delta G^\ddagger$ ) at large negative $\Delta G^0$ values

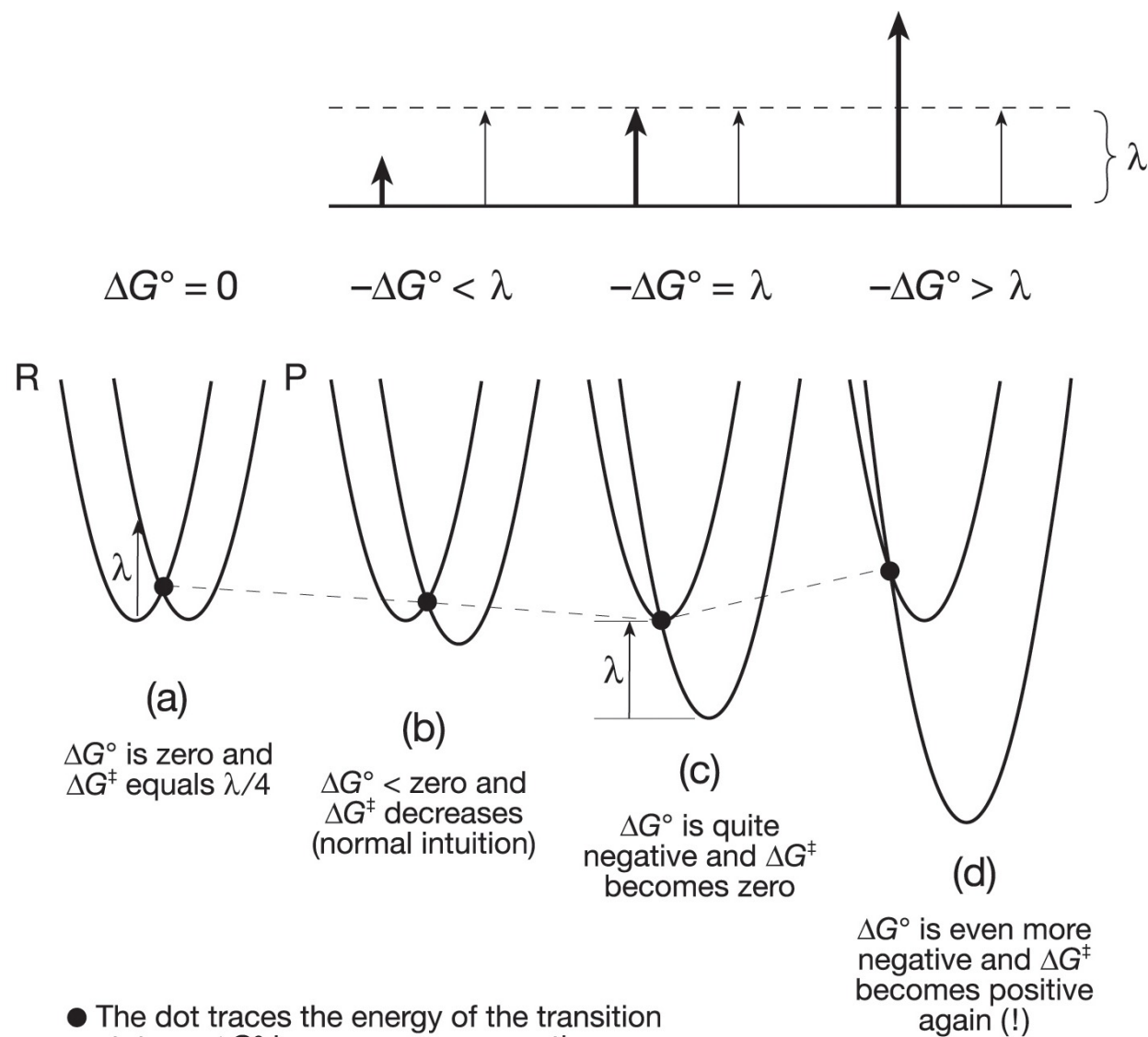

$$k_{cs} = \frac{2\pi^{3/2}}{h\sqrt{\lambda k_B T}} (V)^2 \exp\left[\frac{-(\Delta G + \lambda)^2 / 4\lambda}{k_B T}\right]$$

**Classical Marcus**

# What is $\lambda$ ?

Total reorganization energy is composed of the solvation component  $\lambda_{\text{outer}}$  (or  $\lambda_{\text{sol}}$ ) and the inner or internal component,  $\lambda_{\text{inner}}$  (or  $\lambda_{\text{int}}$ )

$$\lambda = \lambda_{\text{inner}} + \lambda_{\text{outer}}$$

The solvent component is usually described in terms of **dielectric continuum theory**

$$\lambda_{\text{outer}} = e^2 \left( \frac{1}{2r_D} + \frac{1}{2r_A} - \frac{1}{r_{AD}} \right) \left( \frac{1}{\epsilon} - \frac{1}{\epsilon_s} \right) \quad r_{AD} = r_A + r_D$$

where  $r_A$  and  $r_D$  are the atomic radii of A and D, respectively,  $\epsilon$  is the dielectric constant of the medium that responds to the electronic polarization ( $\epsilon$  is the square of the refractive index), and  $\epsilon_s$  is the static dielectric constant or relative permittivity corresponding to the solvent dipole.

The intramolecular component is most generally expressed as a **summation over all vibrational modes  $f_i$  of the reactant state and product state** which undergo change during the electron transfer reaction. The  $\Delta q_i$  is the displacement caused by the electron transfer reaction

$$\lambda_{\text{inner}} = \sum_i \left( \frac{f_i^R f_i^P}{f_i^R + f_i^P} \right) \Delta q_i$$

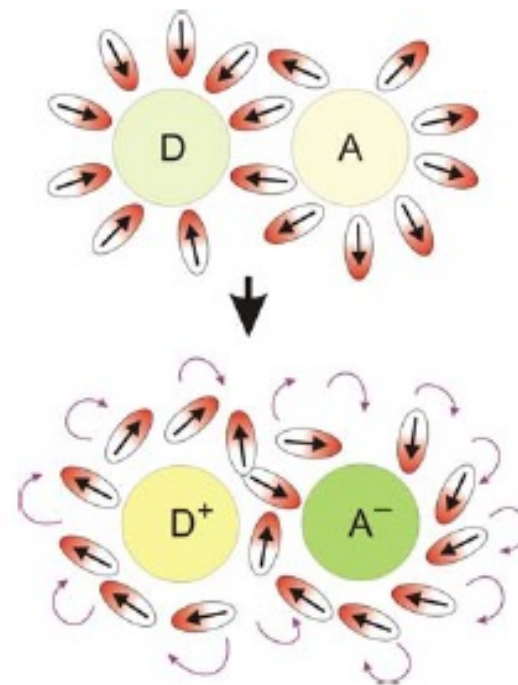

# What is V ?

## Marcus Theory

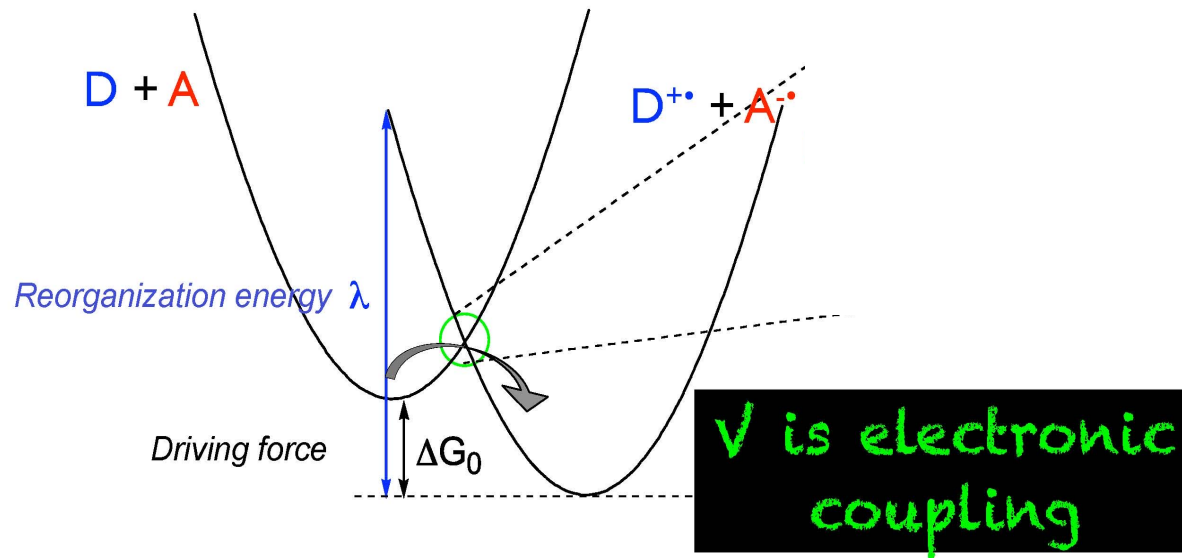

$$k_{et} = \frac{2\pi^{3/2}}{h\sqrt{\lambda k_B T}} V^2 e^{-(\Delta G_0 + \lambda)^2 / 4\lambda k_B T}$$

Classical Marcus equation

## Avoided crossing of potential energy surfaces

In order for electron transfer to occur, an overlap between the populated orbital of the donor and the empty orbital of the acceptor is necessary in the activated complex. This electronic interaction involves a split of electronic energy levels.

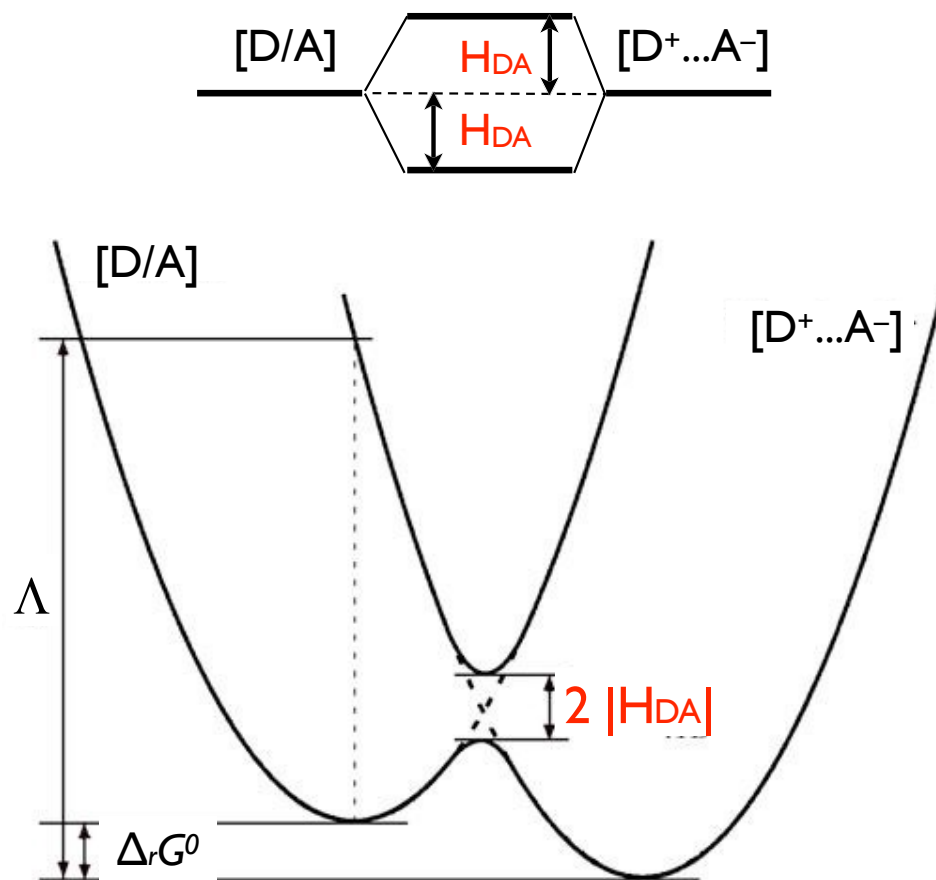

If the electronic states are of the same symmetry, breakage of the Frank-Condon principle at the saddle point causes in turn a split of potential energy levels and **avoided crossing** of the two curves.

As a result, two potential surfaces are created that are separated at the configuration of the activated complex by an energy gap  $2|H_{DA}|$ .  $|H_{DA}|$  is a matrix element for *electronic coupling* between the donor and the acceptor.

# What is $V$ ?

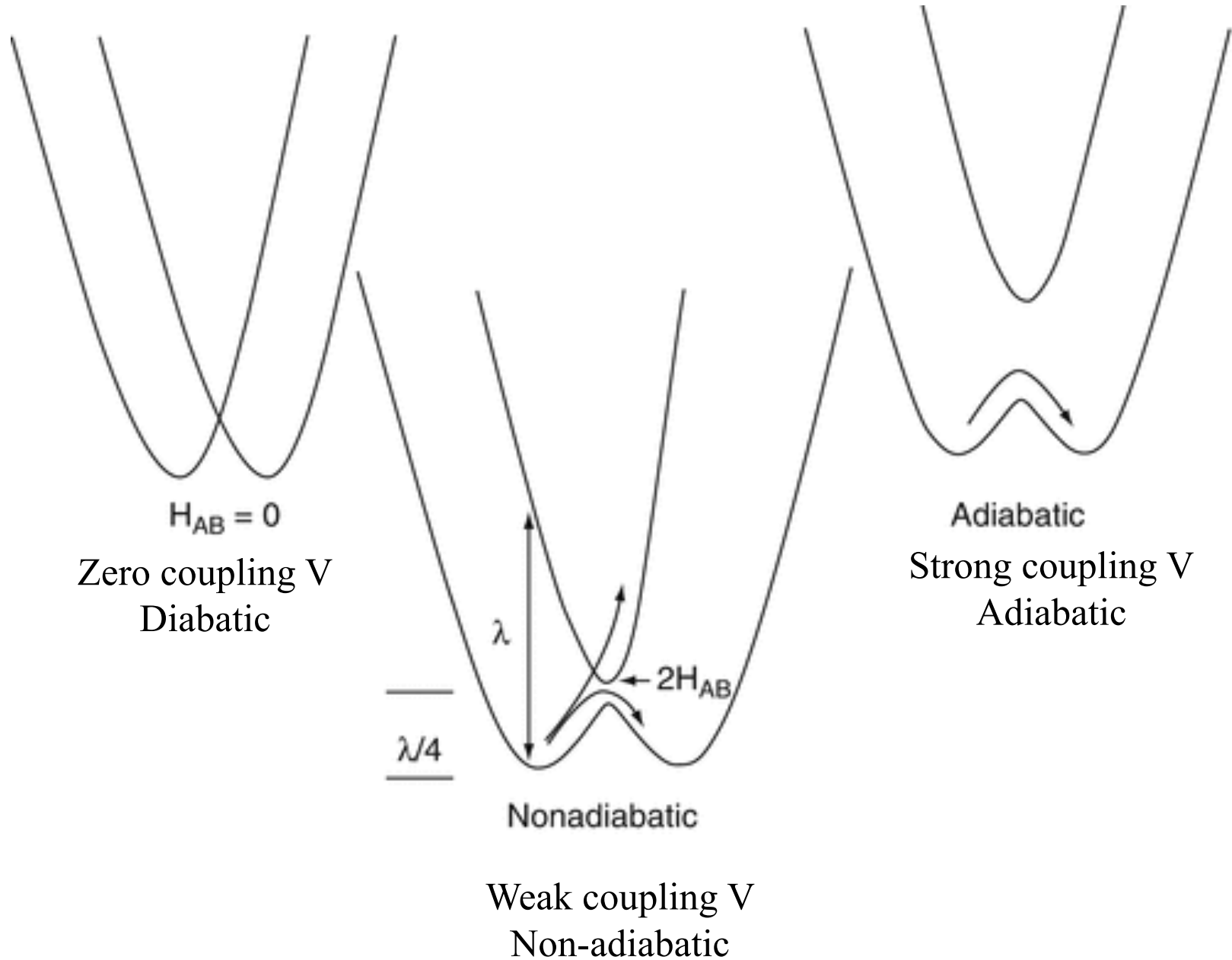



# Forward and back electron transfers have different $\Delta G^0$ and therefore different rates $C_S$ and $C_R$

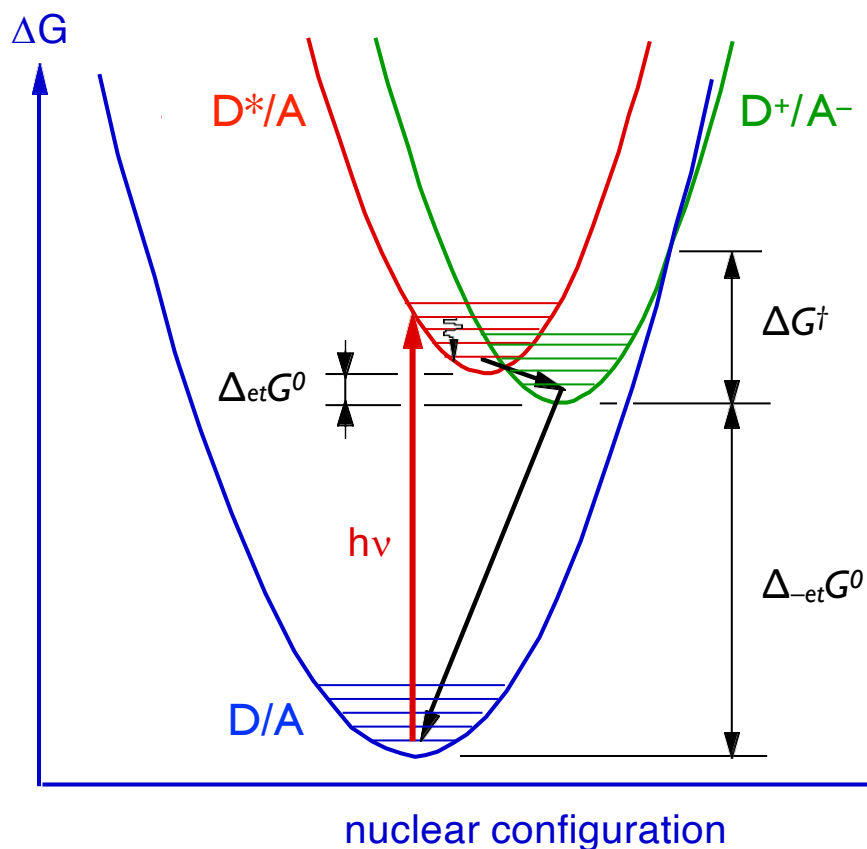

In practical applications of photo-induced ET reactions, charge separation has to be maintained during a period of time sufficient for further redox reactions to take place. Ideally, forward ET involving an excited state has to be as fast as possible, while back electron transfer during which charges recombine has to be slow.

Such an ideal situation is achieved when the energetics of the system implies activation-less forward ET and very exoergic back ET process situated in the inverted Marcus region.

# Forward and backward electron transfer rates are not the same: Charge separation

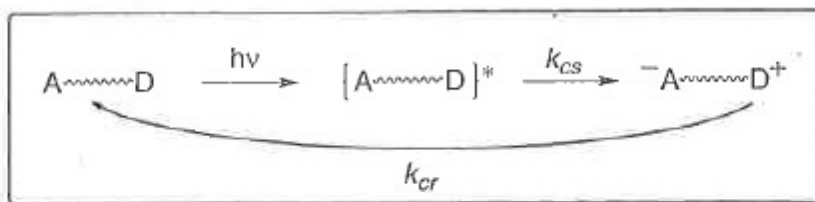
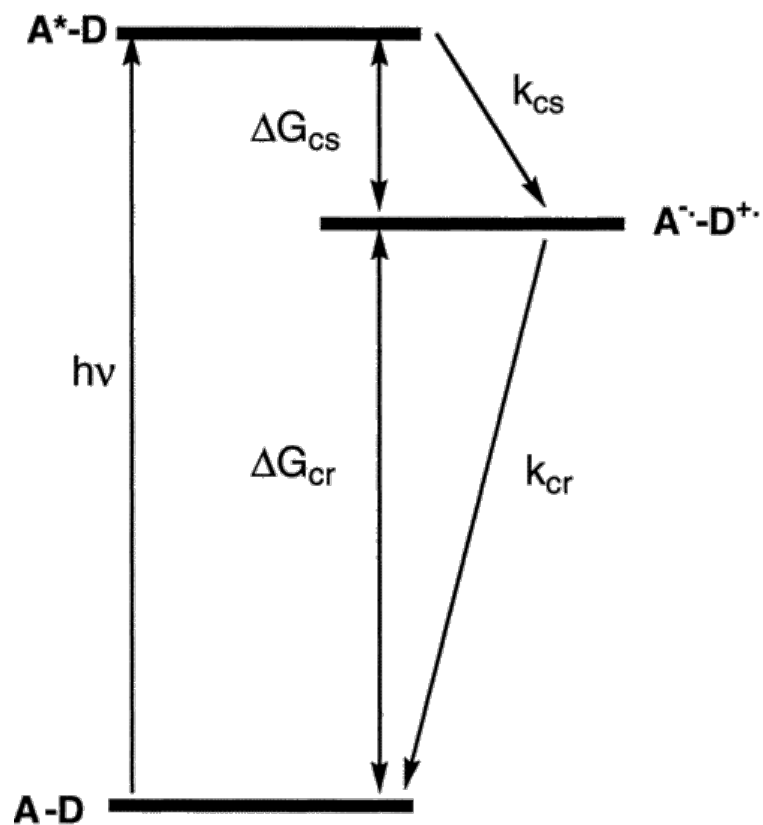

Structure	$k_{cs}$ ( $s^{-1}$ )	$k_{cr}$ ( $s^{-1}$ )
<p>Ar = phenyl 44(6)</p>	$2.7 \times 10^9$	$2.0 \times 10^8$
<p>Ar = 3,5-di-<i>tert</i>-butylphenyl 45(9)</p>	$1.0 \times 10^{10}$	$2.4 \times 10^6$
<p>Ar = 3,5-di-<i>tert</i>-butylphenyl 47</p>	$9.0 \times 10^9$	$2.0 \times 10^9$

## Easier to observe Marcus inversion during back electron transfer process

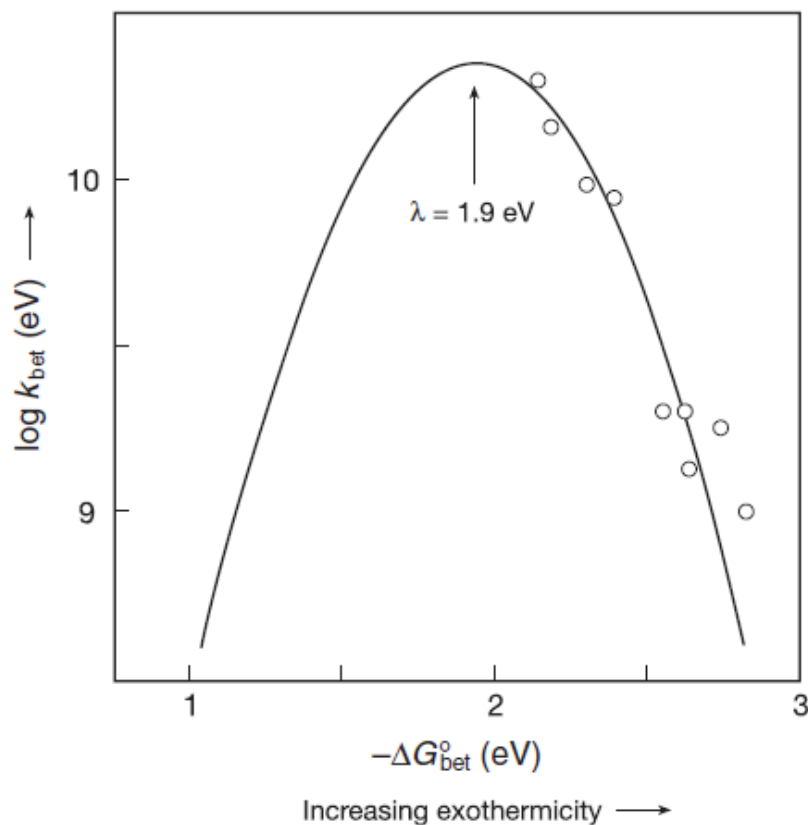
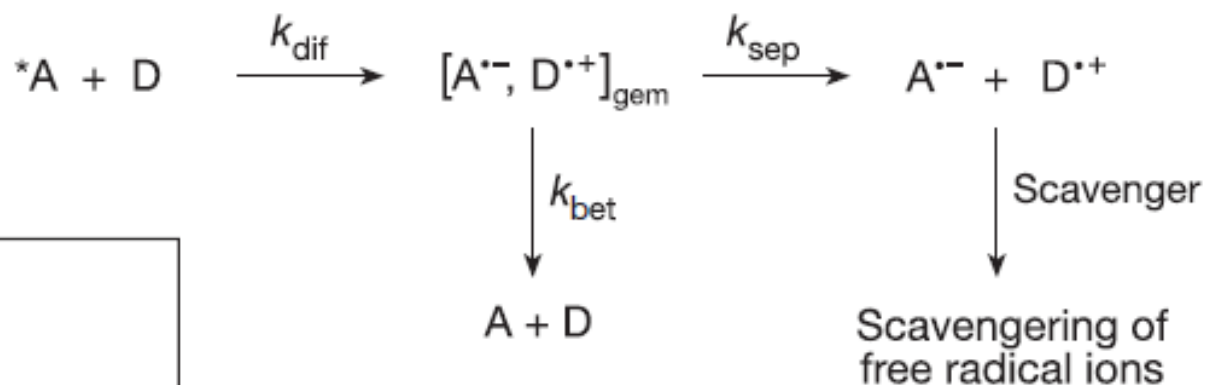

**Caution:** The internal reorganization energy and the electronic coupling  $V$  are generally not the same for charge separation and recombination.

As a result, the charge separation and recombination rates in the same donor-acceptor system usually do not belong to the same Marcus curve.

Dynamics of Bimolecular Photoinduced Electron-Transfer Reactions, I. R. Gould and S. Farid, *Acc. Chem. Res.* **1996**, *29*, 522-528.

## Back electron transfer & Generation of excited states

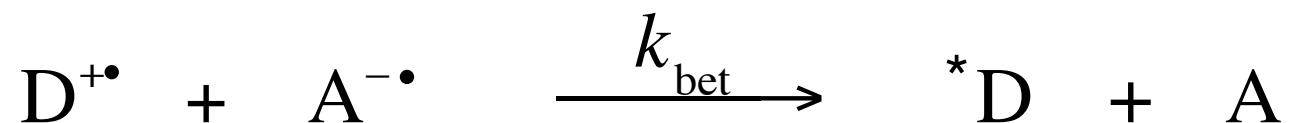

When back electron transfer to the ground state



is in the Marcus inverted region it is inhibited.

the formation of the excited products



may be kinetically preferred because of the smaller  $\Delta G^{0*}_{\text{et}}$

# Excited state production through back electron transfer

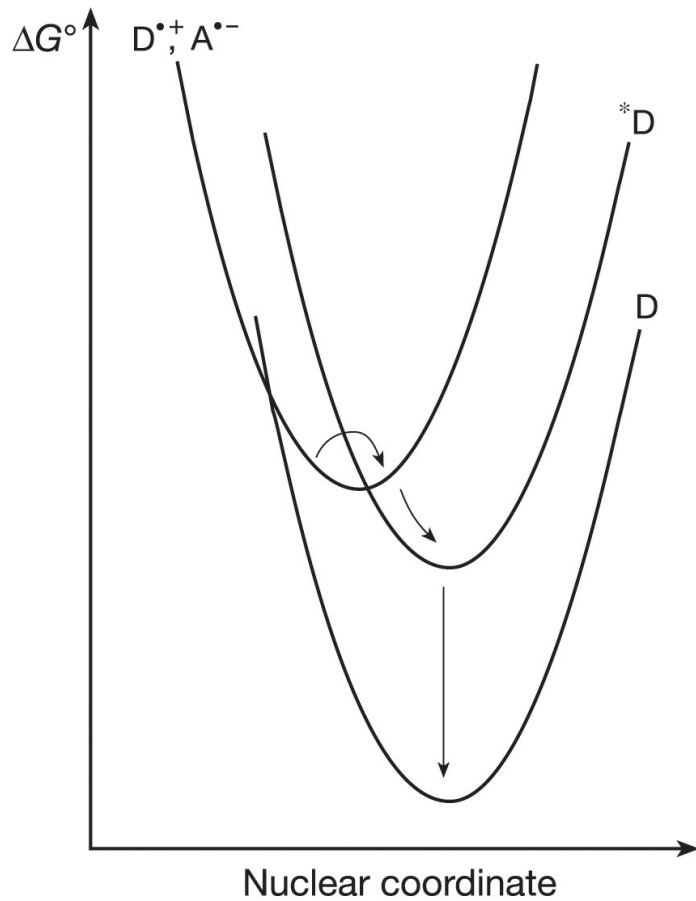

$D^*/A^*$  could be singlet or triplet

$D^{\bullet+}/A^{\bullet-}$  could be singlet or triplet

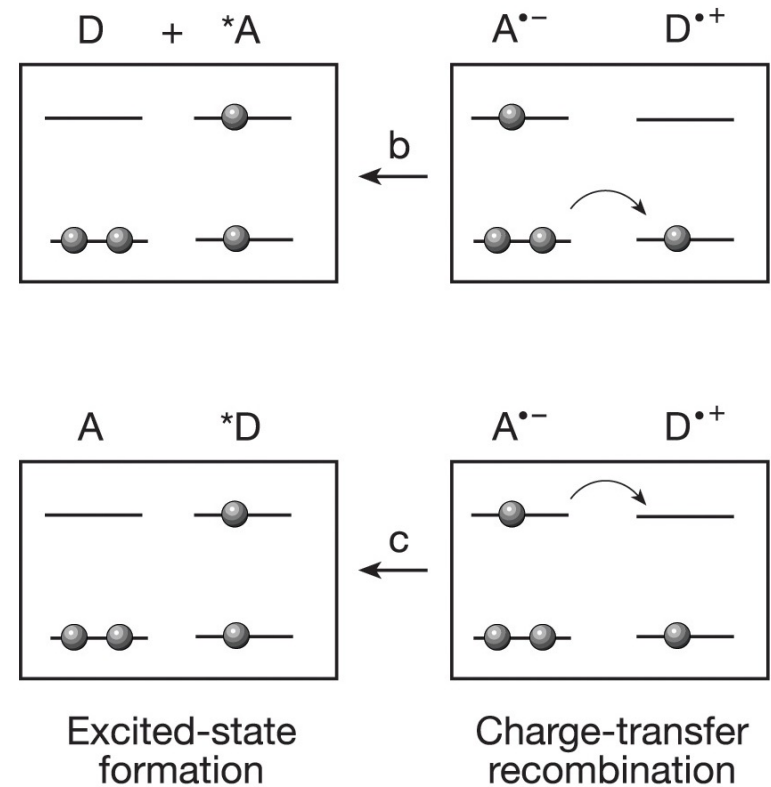

Bioapplications, Light emitting diodes (TV, Computerr, Cell phone screens)

# The Nobel Prize in Physics 2014

"for the invention of efficient blue light-emitting diodes which has enabled bright and energy-saving white light sources."



Isamu Akasaki



Hiroshi Amano



Shuji Nakamura

# Charge separation and Photosynthesis

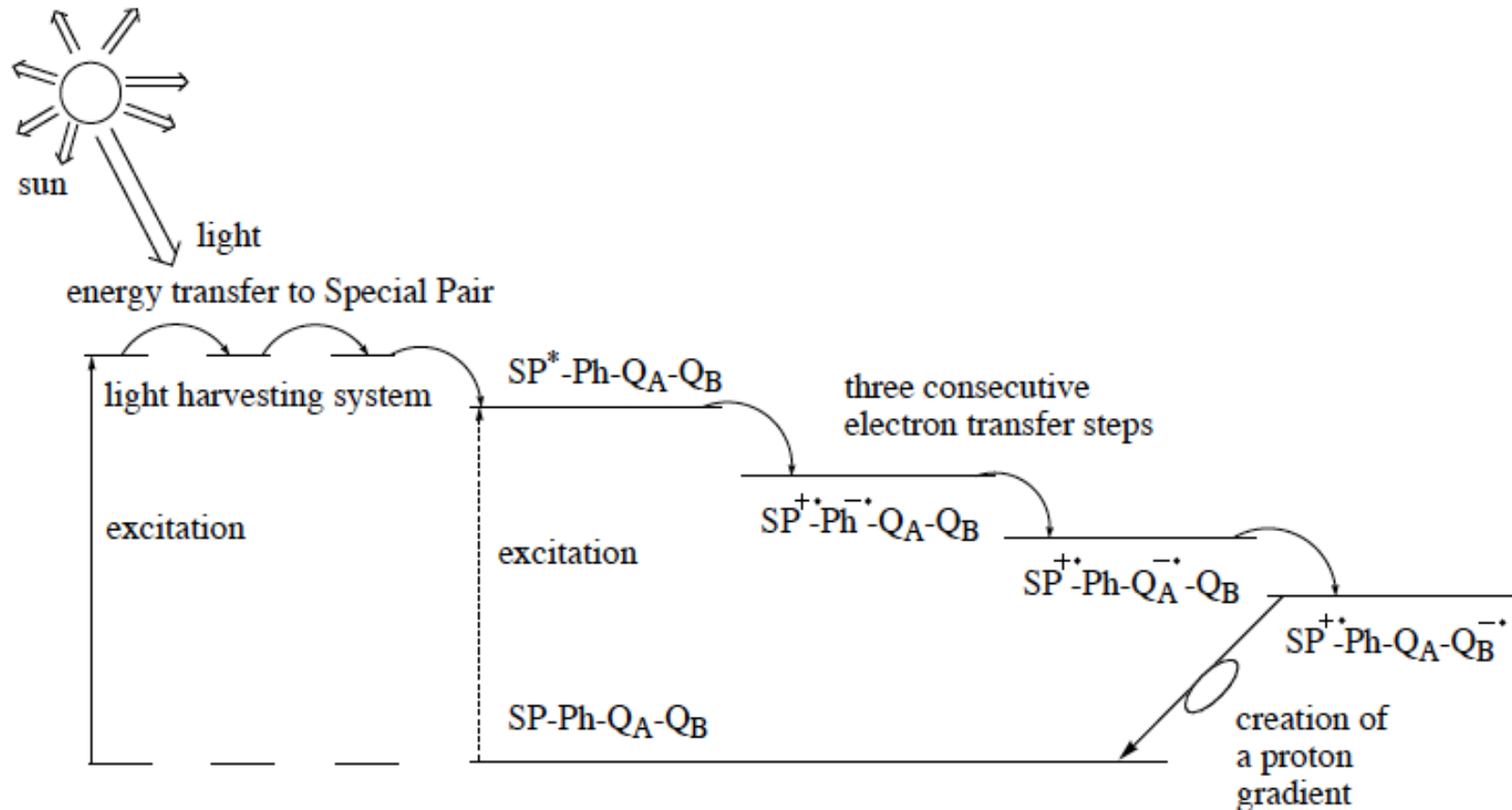

**Fig. 2.** Representation of the first events in photosynthesis. Light harvesting, followed by energy transfer to the special pair, and subsequently by three electron transfer steps. The charge separated state is used to create a transmembrane proton gradient.



# Charge Separation: Diads, Triads and Tetrads

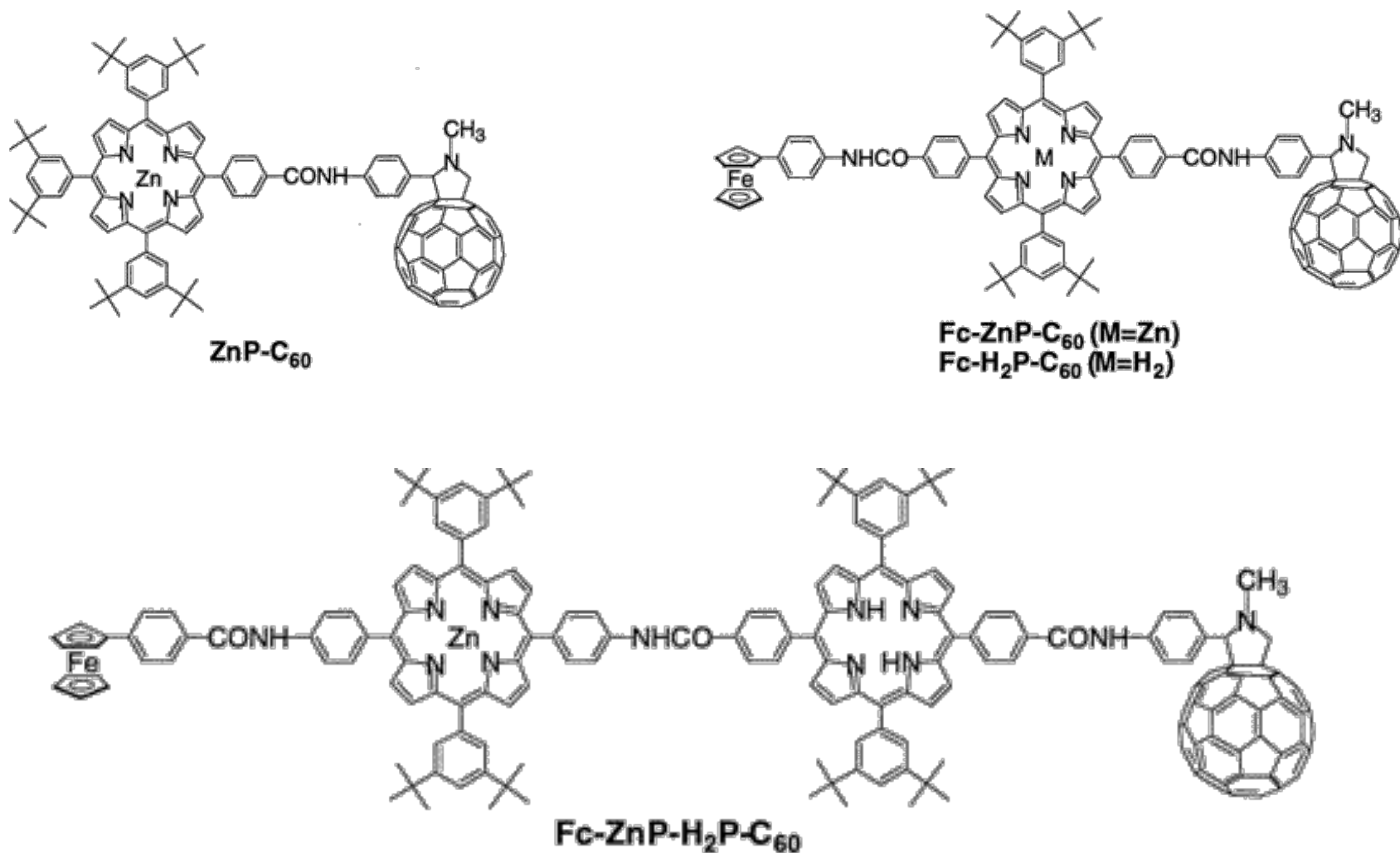

Molecular Mimicry of Photosynthetic Energy and Electron Transfer, D. Gust, T. A. Moore, and A. L. Moore, *Acc. Chem. Res.*, **1993**, 26, 198

# Cascade electron transfer in a triad



Devens Gust

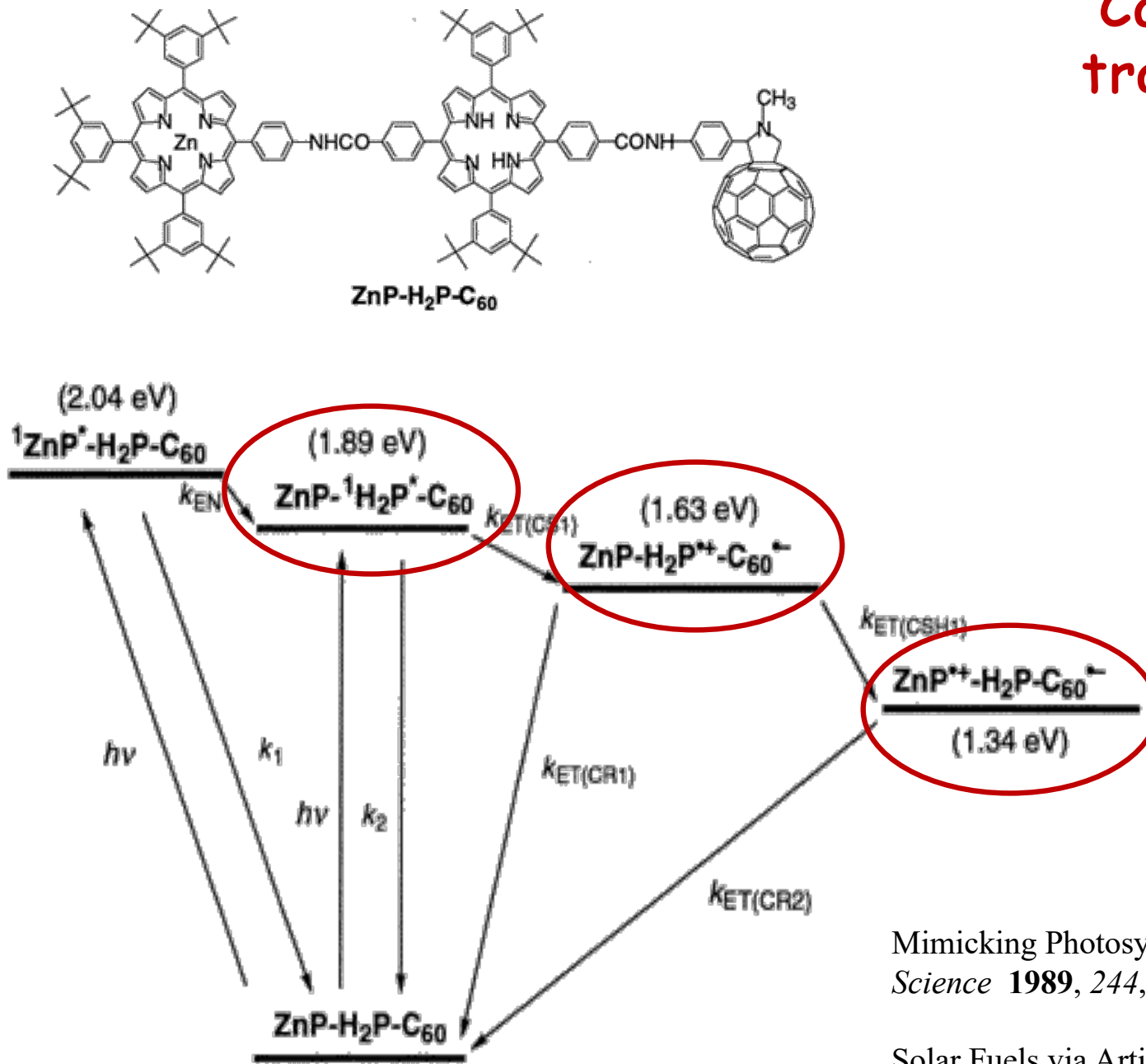

Mimicking Photosynthesis, D. Gust, T. A. Moore, *Science* **1989**, 244, 35-41.

Solar Fuels via Artificial Photosynthesis, D. Gust, T. A. Moore, and A. L. Moore, *Acc. Chem. Res.*, **2009**, 42, 1890

# Cascade electron transfer in a tetrad

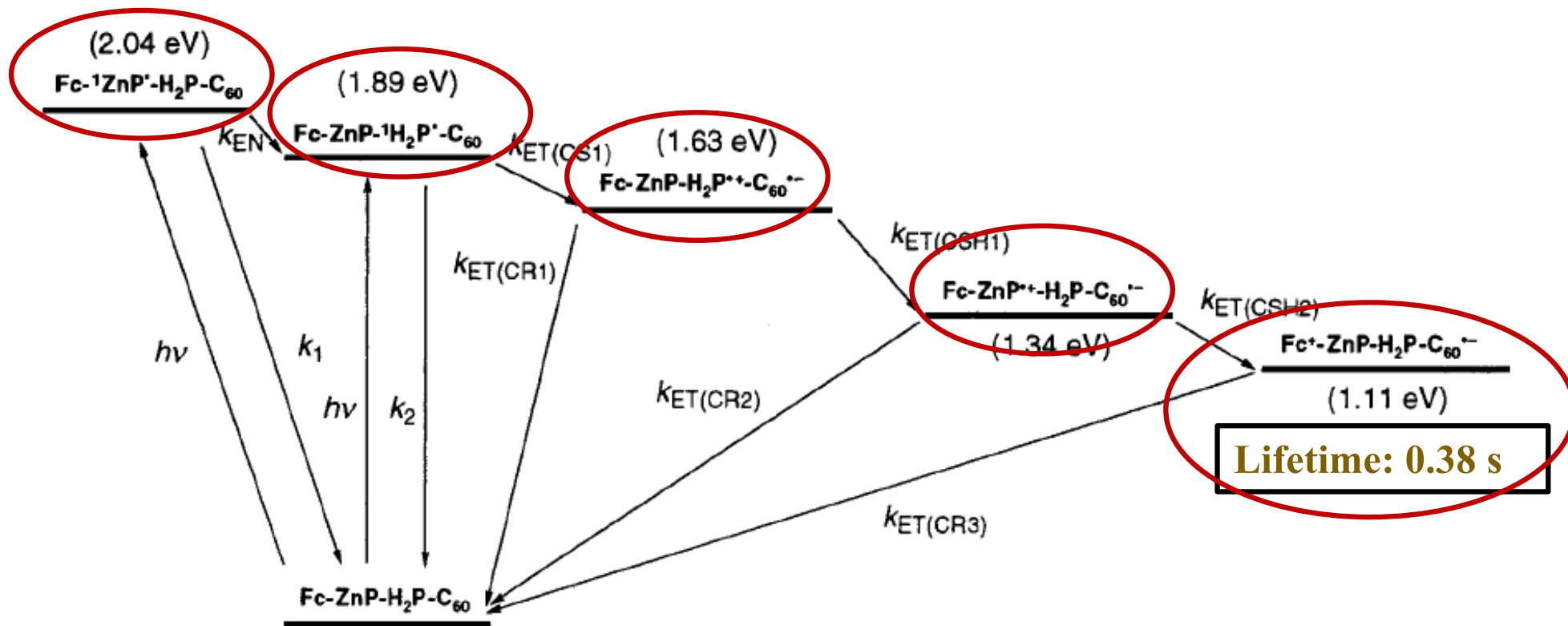

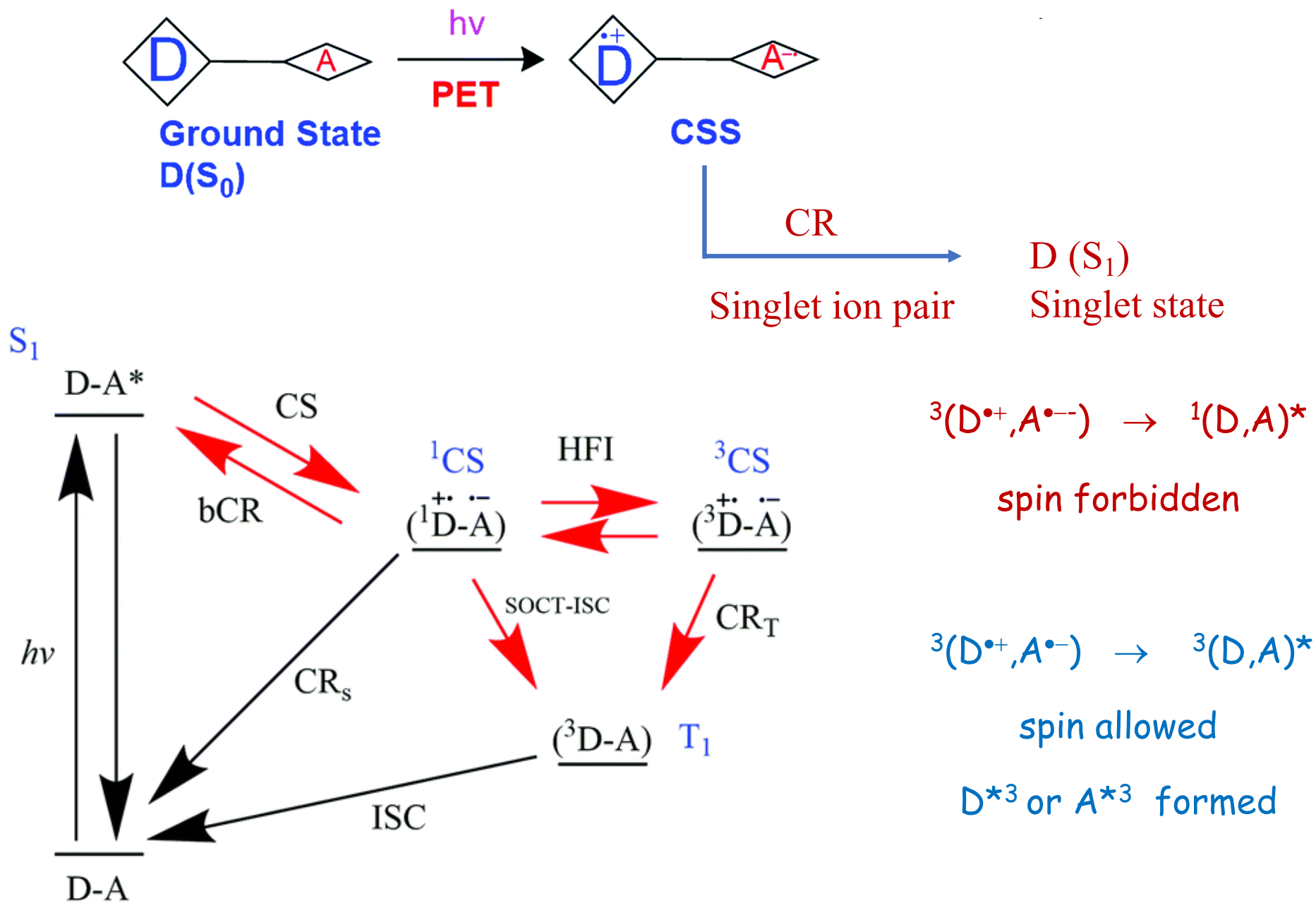

Making triplets from photo-generated charges: observations, mechanisms and theory, D. J. Gibbons, A. Farawar, P. Mazzell, S. Leroy-Lhez and René M. Williams, *Photochem. Photobiol. Sci.*, **2020**, *19*, 136

# Role of Spin: Triplet ion pairs have longer lifetime

Benzophenone  
as triplet  
sensitizer

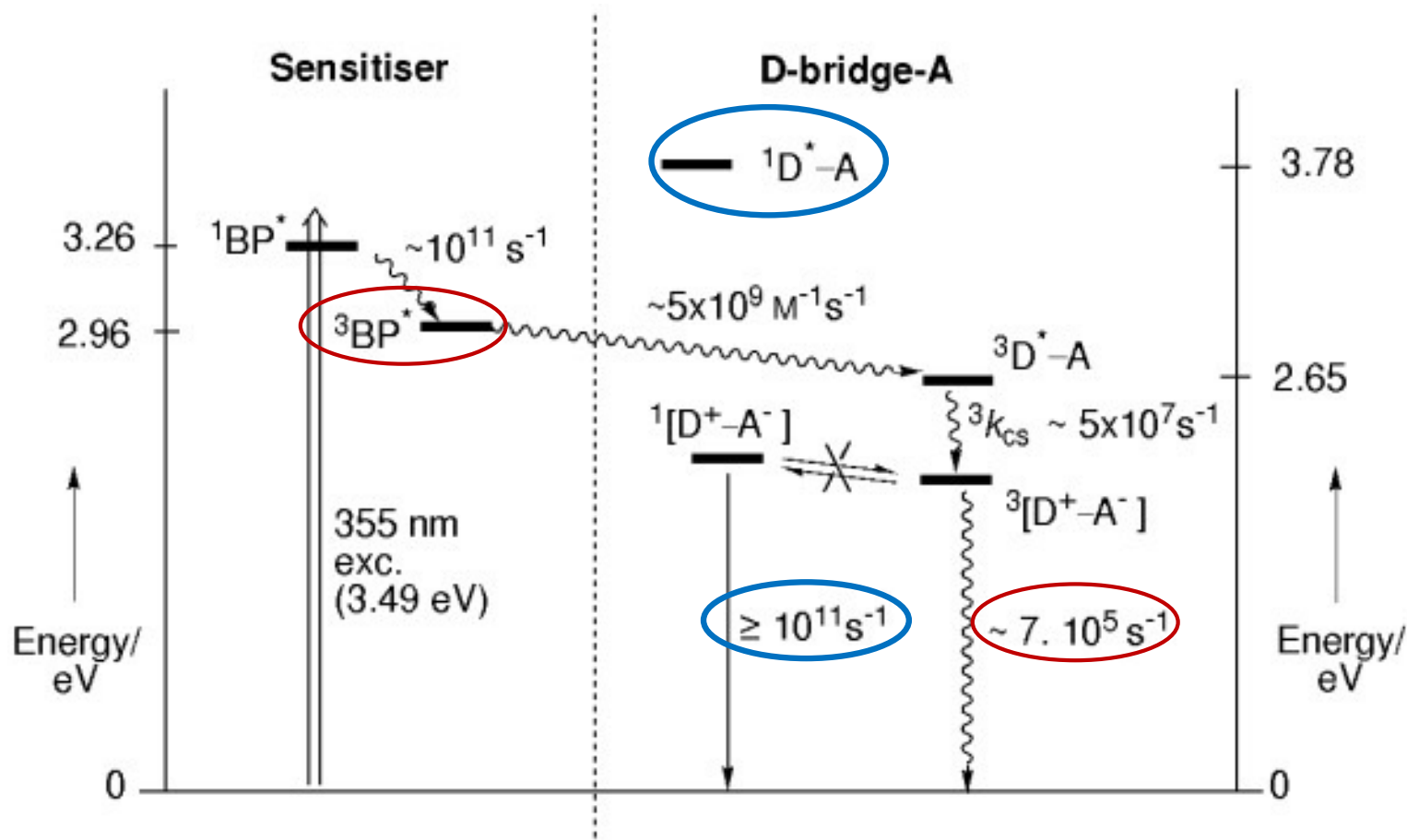
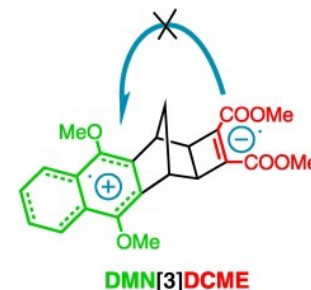
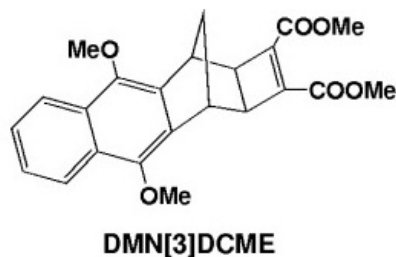

# Electron Transfer at a Distance

No need for Donor & Acceptor Orbitals to Overlap

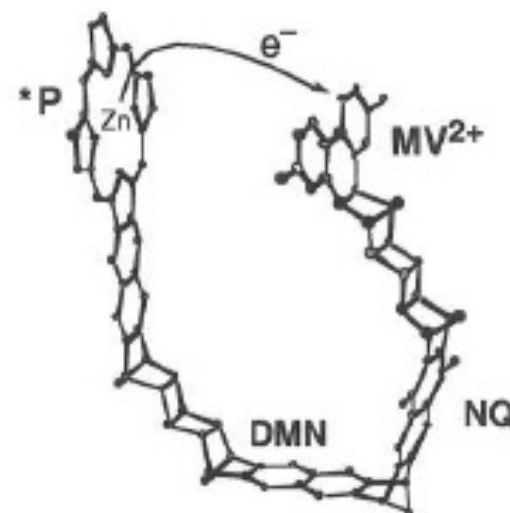
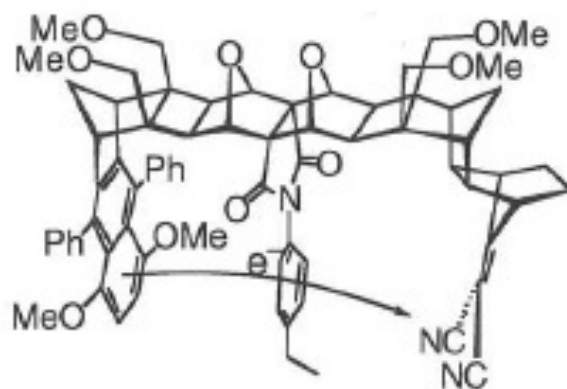
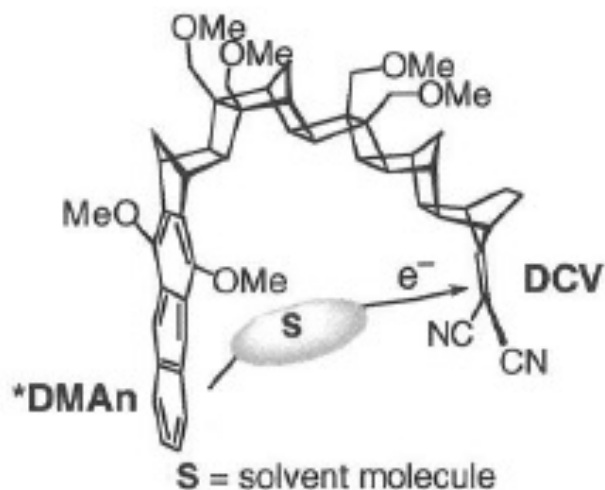
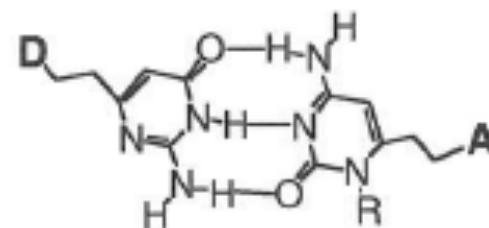
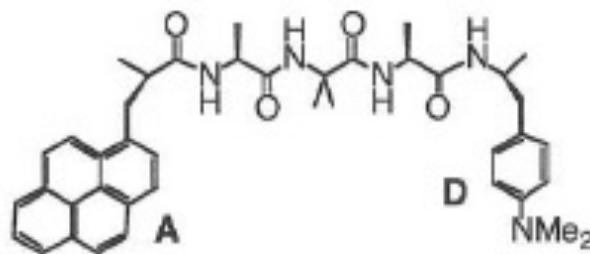
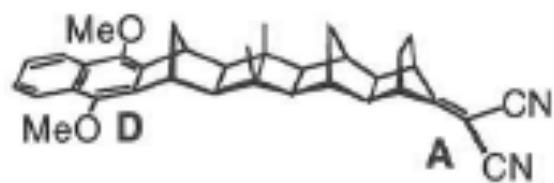

# Electron transfer through $\sigma$ bonds

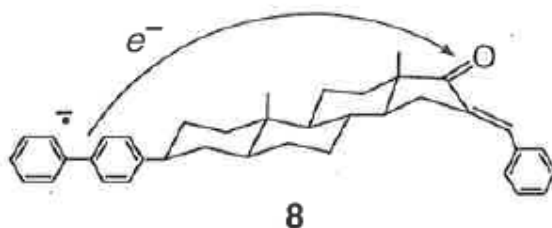

$$\Delta G_{el} = -1.1 \text{ eV}$$

$$k_{et} > 10^9 \text{ s}^{-1}$$

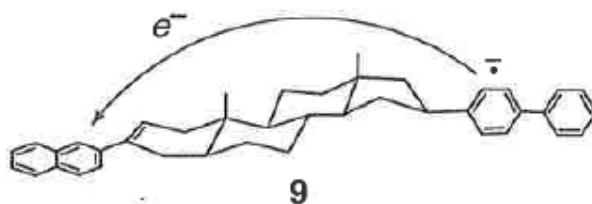

$$\Delta G_{el} = -0.32 \text{ eV}$$

$$k_{et} = 4.0 \times 10^7 \text{ s}^{-1}$$

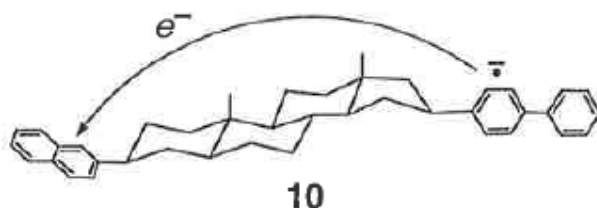

$$\Delta G_{el} = -0.05 \text{ eV}$$

$$k_{et} = 1.0 \times 10^6 \text{ s}^{-1}$$

On the role of spin correlation in the formation, decay, and detection of long-lived, intramolecular charge-transfer states, Jan W. Verhoeven, *J. Photochem. Photobiol. C: Photochem. Rev.*, **2006**, 7, 40–60

Investigating Long-Range Electron-Transfer Processes with Rigid, Covalently Linked Donor-(Norbornylogous Bridge)-Acceptor Systems, M. Paddon-Row, *Acc. Chem. Res.* **1994**, 27, 18-25



# Long distance electron transfer and the distance dependence of the coupling element $V_{DA}$

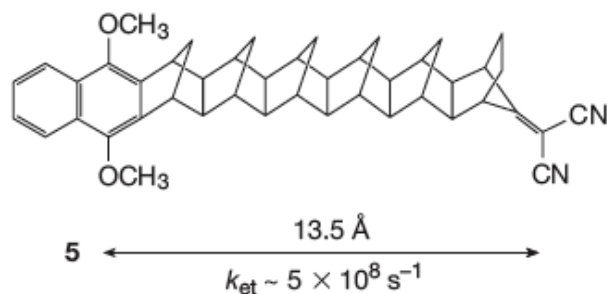
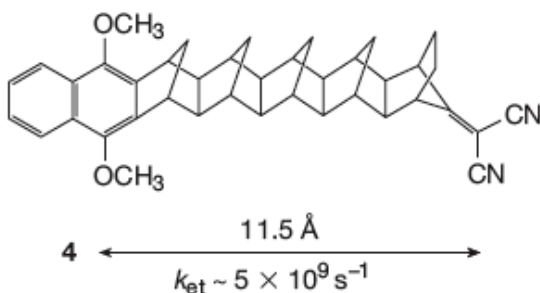
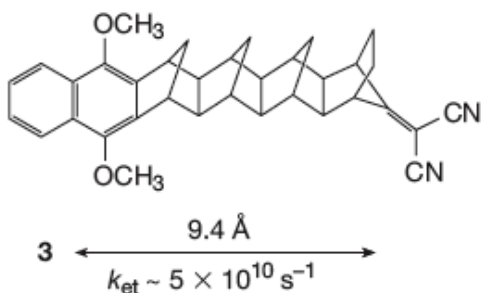
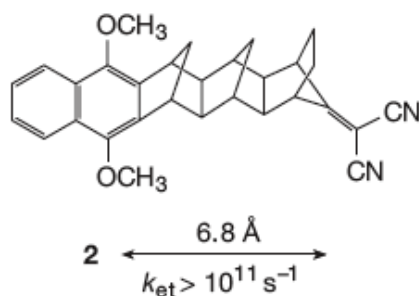
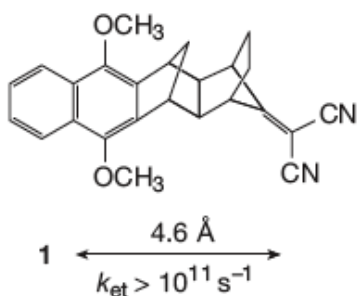





J. W. Verhoven

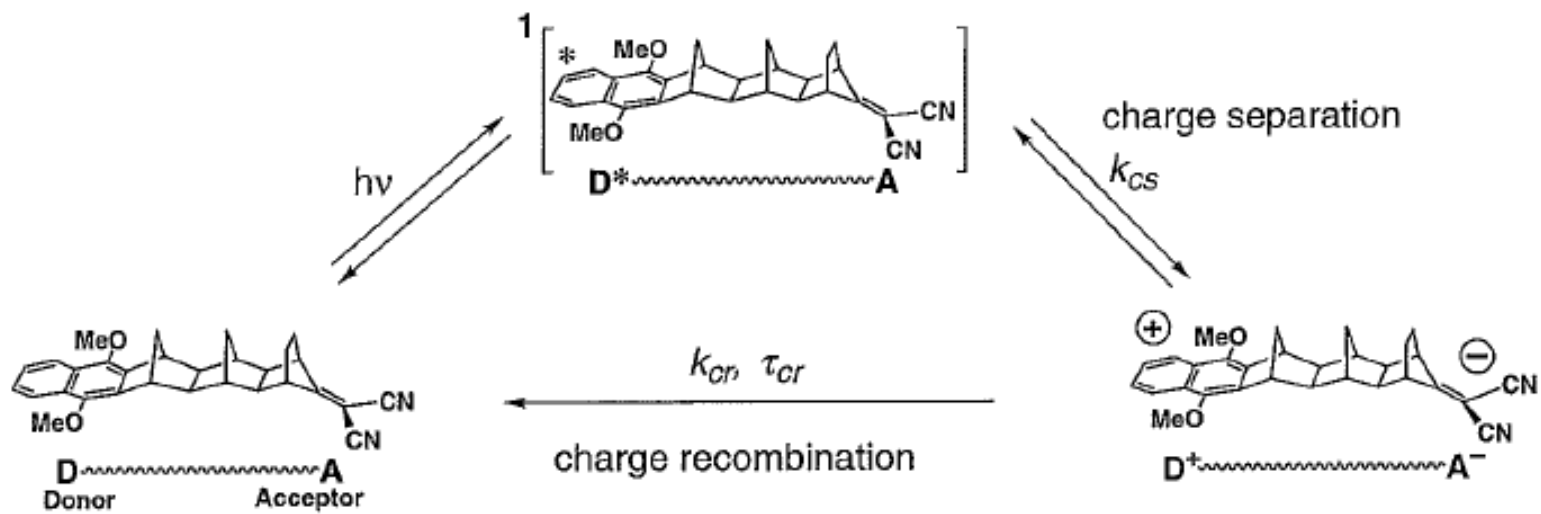

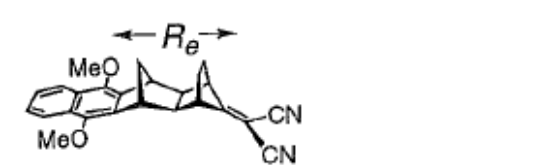
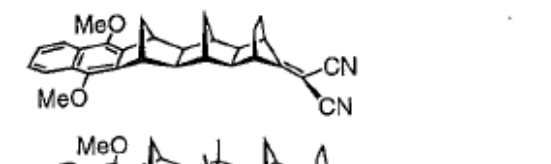
M. N. Paddon-Row

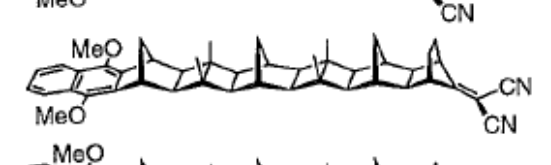

	$R_e$ (Å)	$k_{CS}$ ( $\times 10^8$ s $^{-1}$ )	$\tau_{cr}$ (ns)	$1/k_{cr}$
	4.6	$\gg 5000$	—	
	6.8	3,300	0.5	
	9.4	670	2.5	
	11.5	120	43	
	13.5	13	297	
	14.2	1.2	1050	

# Difference between super-exchange and molecular wire

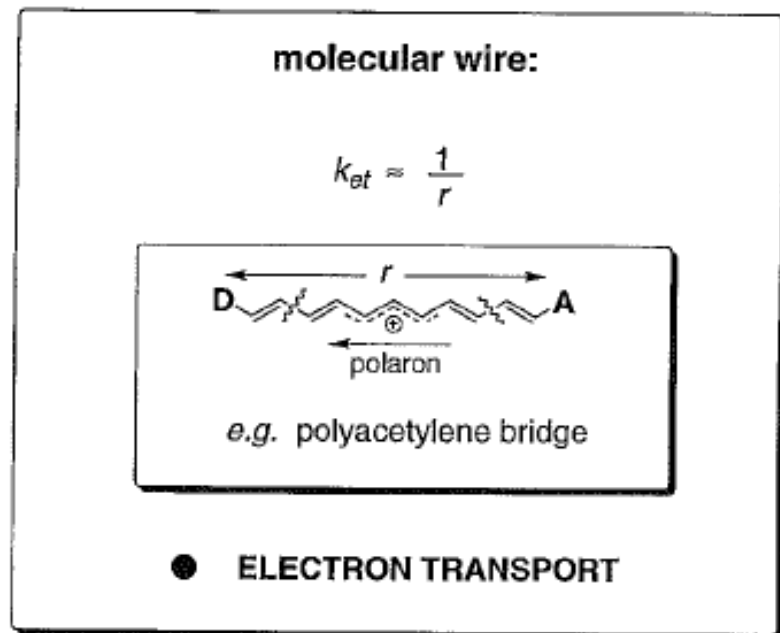
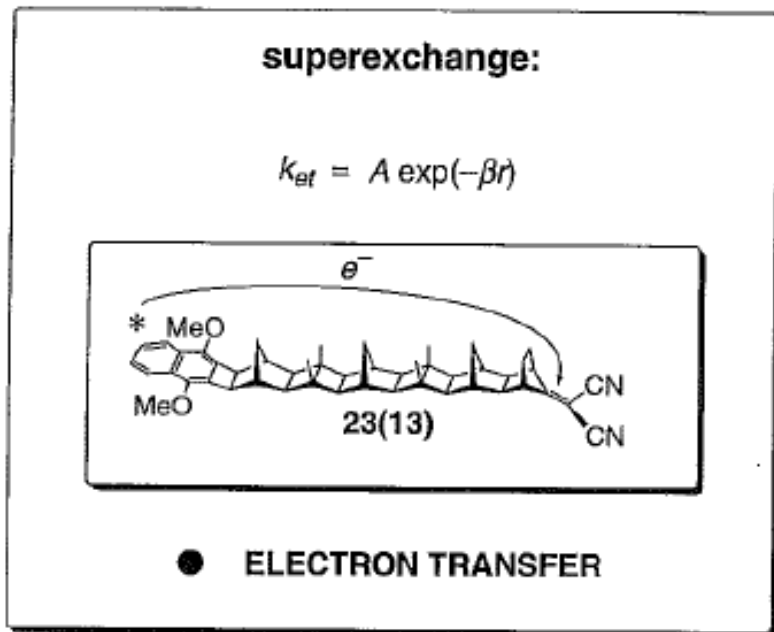
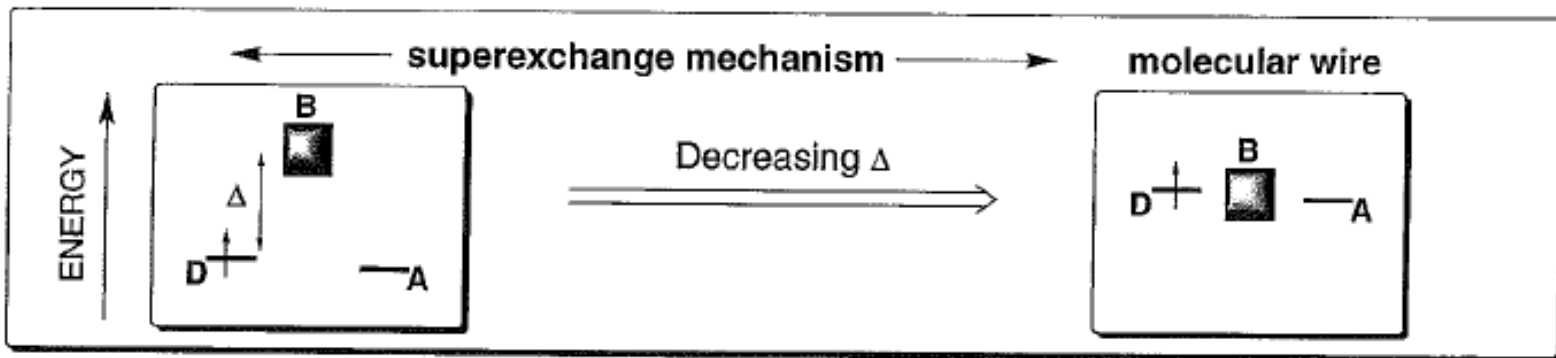

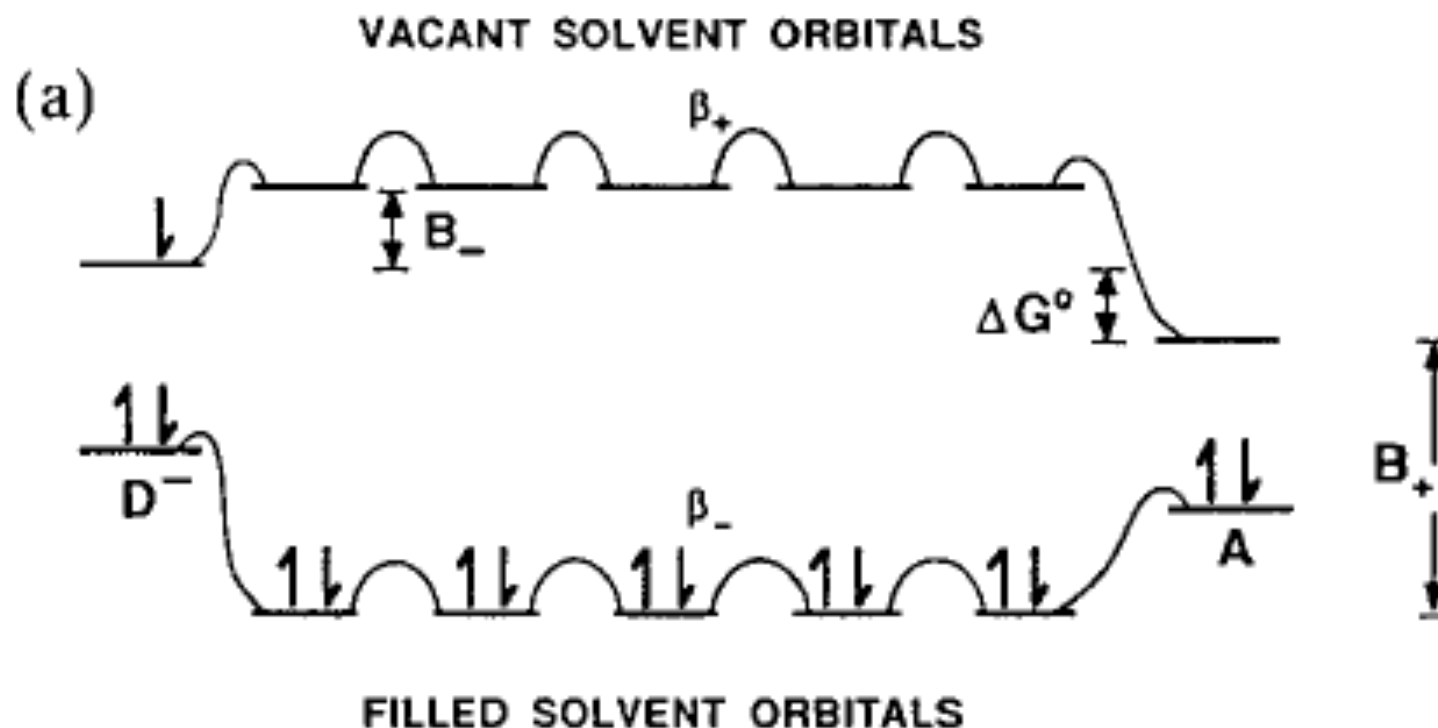

**Through-bond interactions in donor-acceptor systems separated by solvent or by covalently bound spacers.**

**Although the available orbitals of the solvent or spacer lie at energies incompatible with intermediate states participating in mediated electron transfer, their presence provides an electronic perturbation of the donor and acceptor orbitals and enhanced electron transfer rates compared with the interactions occurring over the same spatial separation with an intervening vacuum.**



Electron transfer



Hole transfer

$$k_{eT} = k_0 \exp[-\beta(R_{DA} - R_0)]$$

Smaller the  $\beta$  the larger the  $k_{eT}$

The propagation of electronic coupling along the bridging material (aka "superexchange" leads to exponential distance dependence.

The initial coupling into the bridge depends on the energy gap between the relevant orbitals of the donor (acceptor) and the bridge,  $\Delta E_{DB}$  and  $\Delta E_{BA}$ , as well as stereoelectronic factors.

$$k_{\text{et}} = k_0 \exp[-\beta(R_{\text{DA}} - R_0)]$$

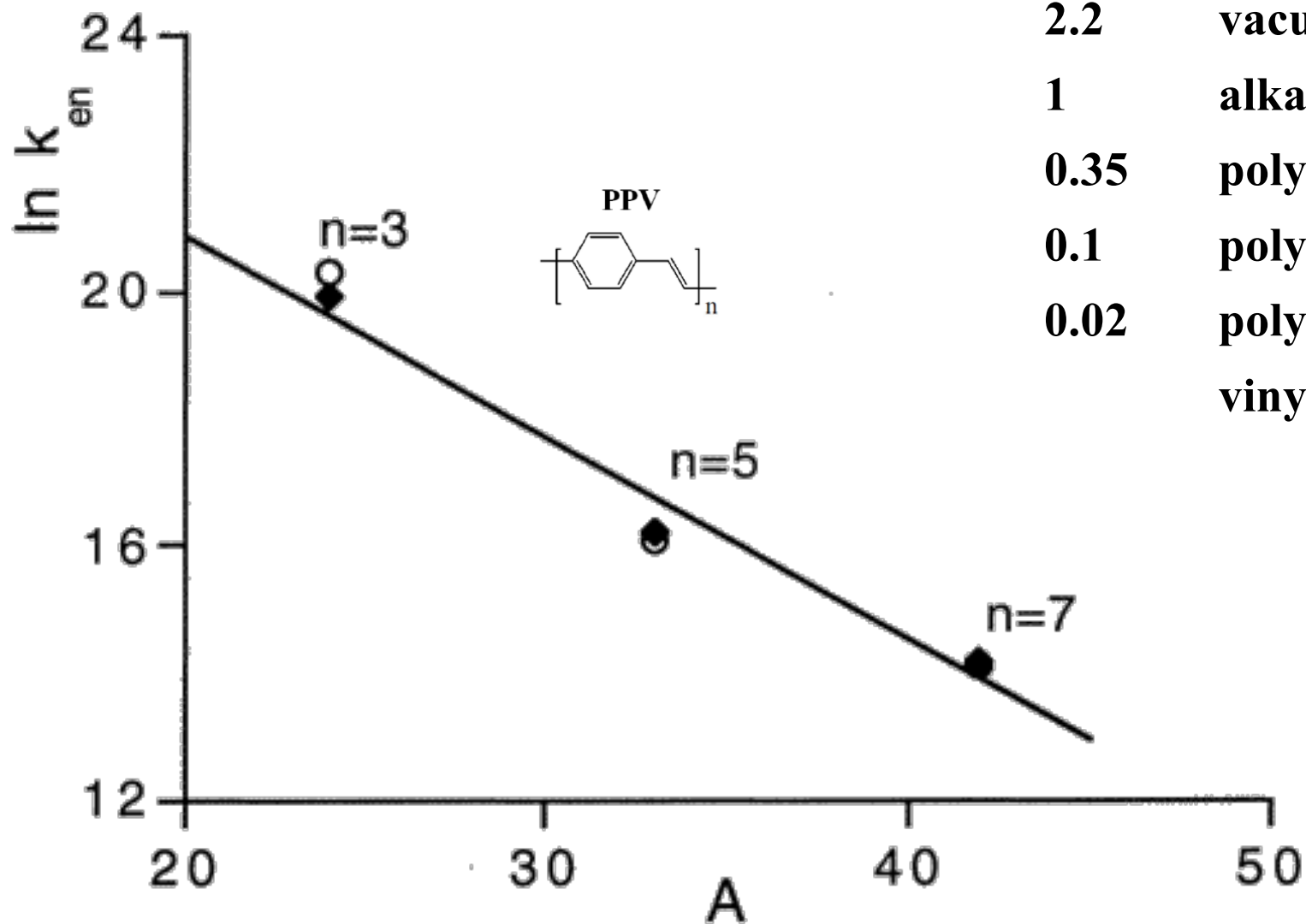

$\beta$  spacer ( $\text{\AA}^{-1}$ )

2.2

vacuum

1

alkanes

0.35

polyphenyl

0.1

polyacetylene

0.02

poly-*p*-phenylene-  
vinylene

How does the rate of electron transfer change with increasing distance between the two groups?

# Distance dependance of electron transfer

$$\beta \text{ for polyphenyl } \beta = 0.32 \text{ \AA}^{-1}$$

Excited state lifetimes of the quenched unit and  
electron transfer rate constants

$$k_{\text{et}} = k_0 \exp[-\beta(R_{\text{DA}} - R_0)]$$

	$\tau$ (ps)	$k_{\text{el}}$ ( $\text{s}^{-1}$ )
$\text{Os}^{\text{II}}(\text{phH})_2\text{Os}^{\text{III}}$	$\leq 5$	$\geq 2 \times 10^{11}$
$\text{Os}^{\text{II}}(\text{phH})_3\text{Os}^{\text{III}}$	8	$1.2 \times 10^{11}$
$\text{Os}^{\text{II}}(\text{phH})_4\text{Os}^{\text{III}}$	34	$2.9 \times 10^{10}$

$\text{Os}^{\text{II}}(\text{ph})_3\text{Os}^{\text{III}}$	17	$5.8 \times 10^{10}$
$\text{Os}^{\text{II}}(\text{ph})_5\text{Os}^{\text{III}}$	340	$2.7 \times 10^9$
$\text{Os}^{\text{II}}(\text{ph})_7\text{Os}^{\text{III}}$	2900	$9.4 \times 10^7$

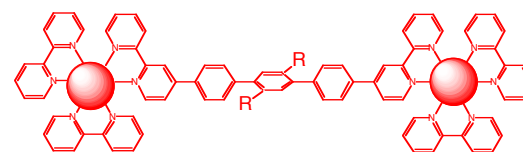
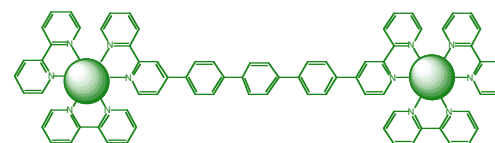

R= hexyl



# Electron transfer through $\sigma$ bonds

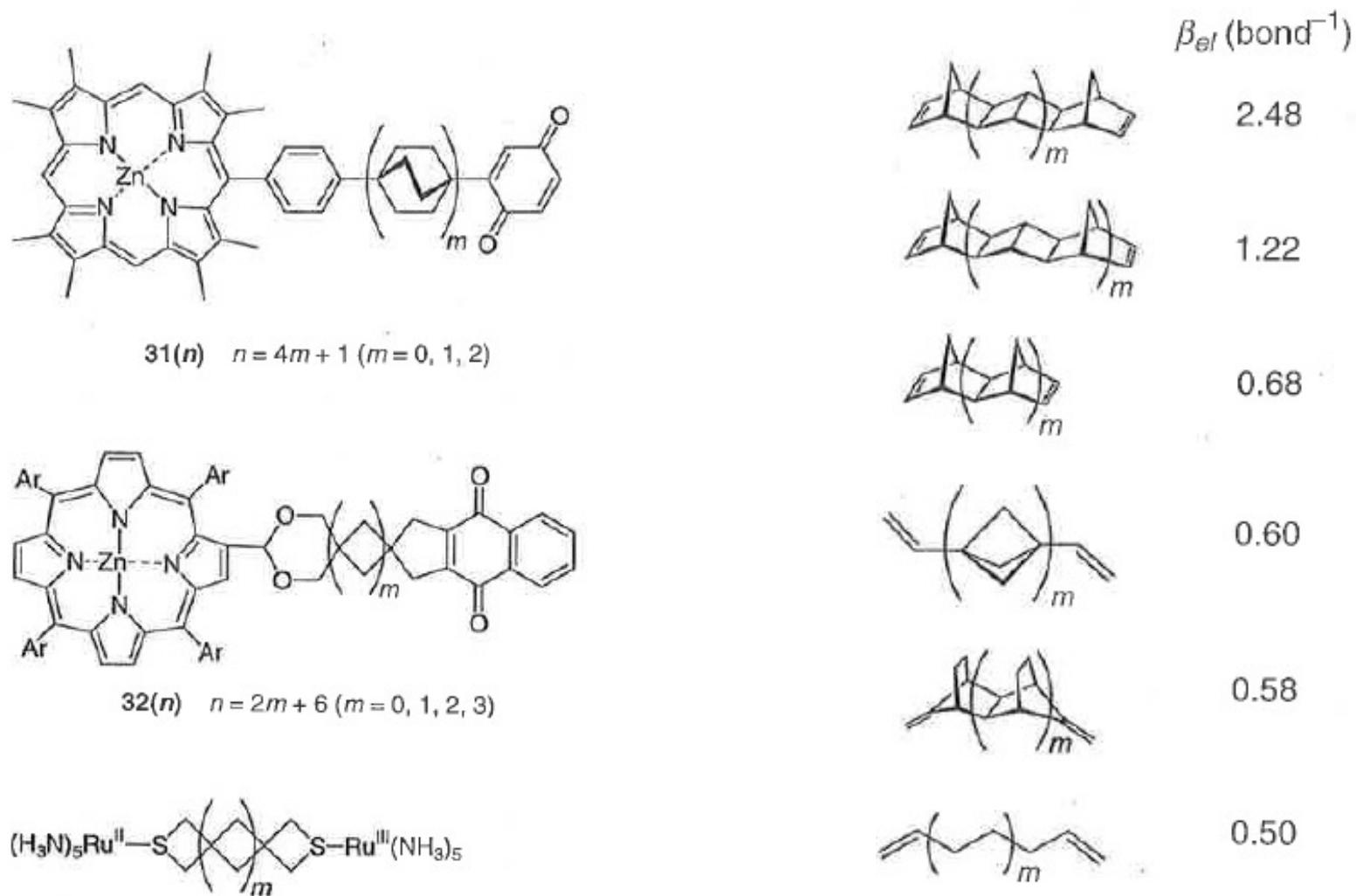

$$k_{et} = k_0 \exp[-\beta(R_{DA} - R_0)]$$

# Long distance electron transfer in proteins

Wenger, Leigh, Villahermosa, Gray, Winkler, *Science*, 2005; 307, 99-102.

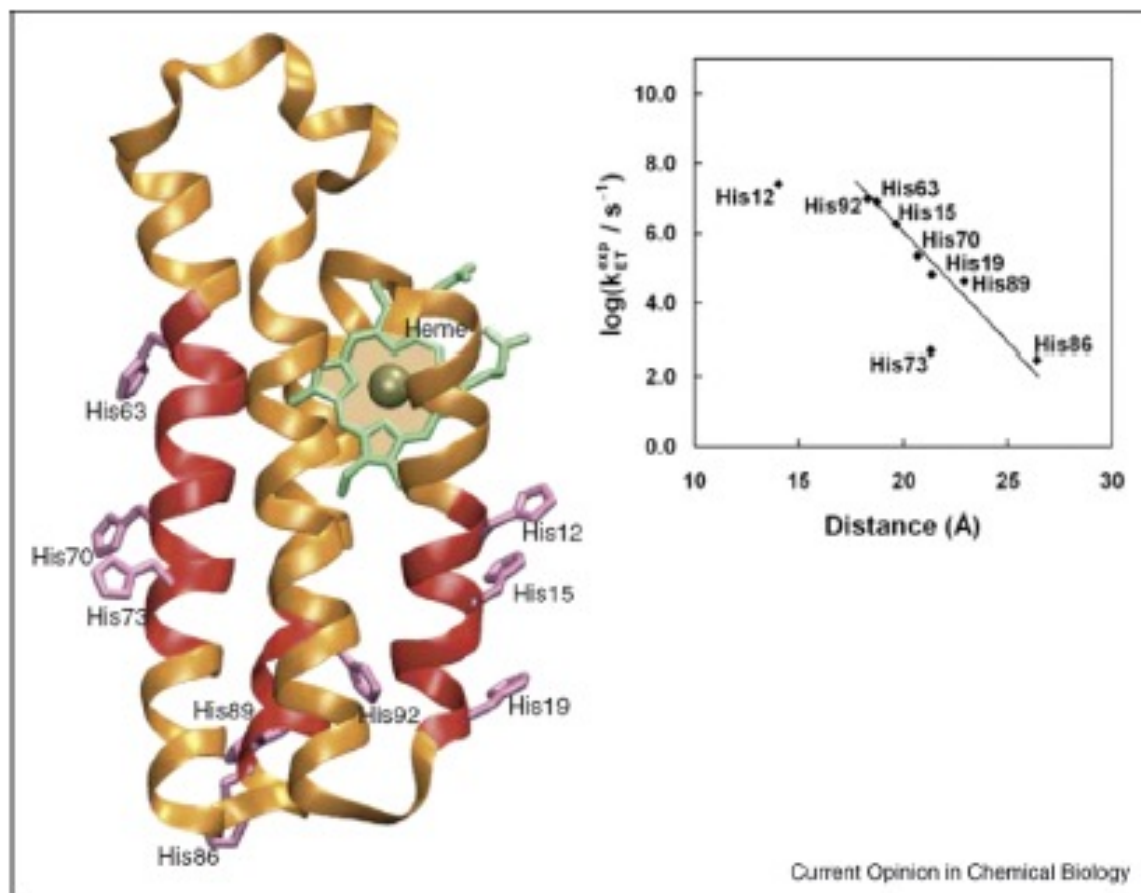

Harry B. Gray

ET rates for nine His-labeled cyt  $b_{562}$  derivatives, seven follow the exponential distance dependency of Eqn (1), whereas in two cases slower rates than predicted by Eqn (1) have been measured [6\*]. Published with permission of Science.

**Activationless electron tunneling through various media:** vacuum (black,  $\beta = 2.9\text{-}4.0 \text{ \AA}^{-1}$ ), MTHF glass (violet,  $\beta = 1.57\text{-}1.67 \text{ \AA}^{-1}$ ), aqueous glass (cyan,  $\beta = 1.55\text{-}1.65 \text{ \AA}^{-1}$ ), and toluene glass (green,  $\beta = 1.18\text{-}1.28 \text{ \AA}^{-1}$ ).

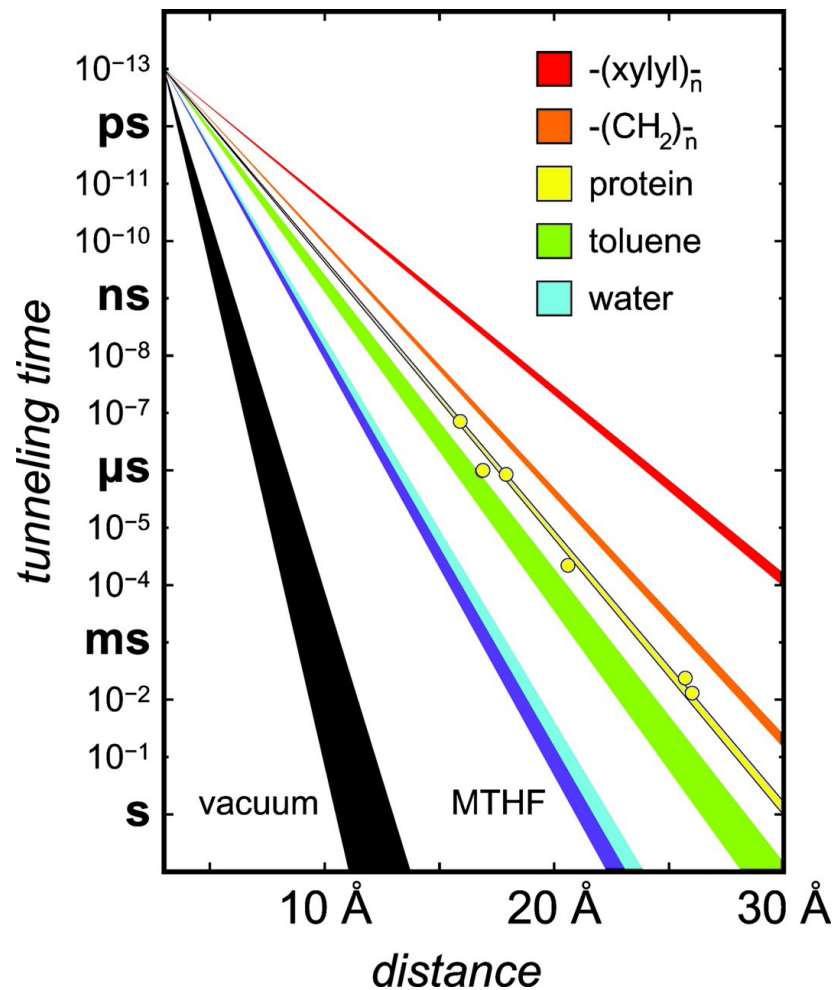

Gray H B , and Winkler J R PNAS 2005;102:3534-3539

# Long distance electron transfer in general

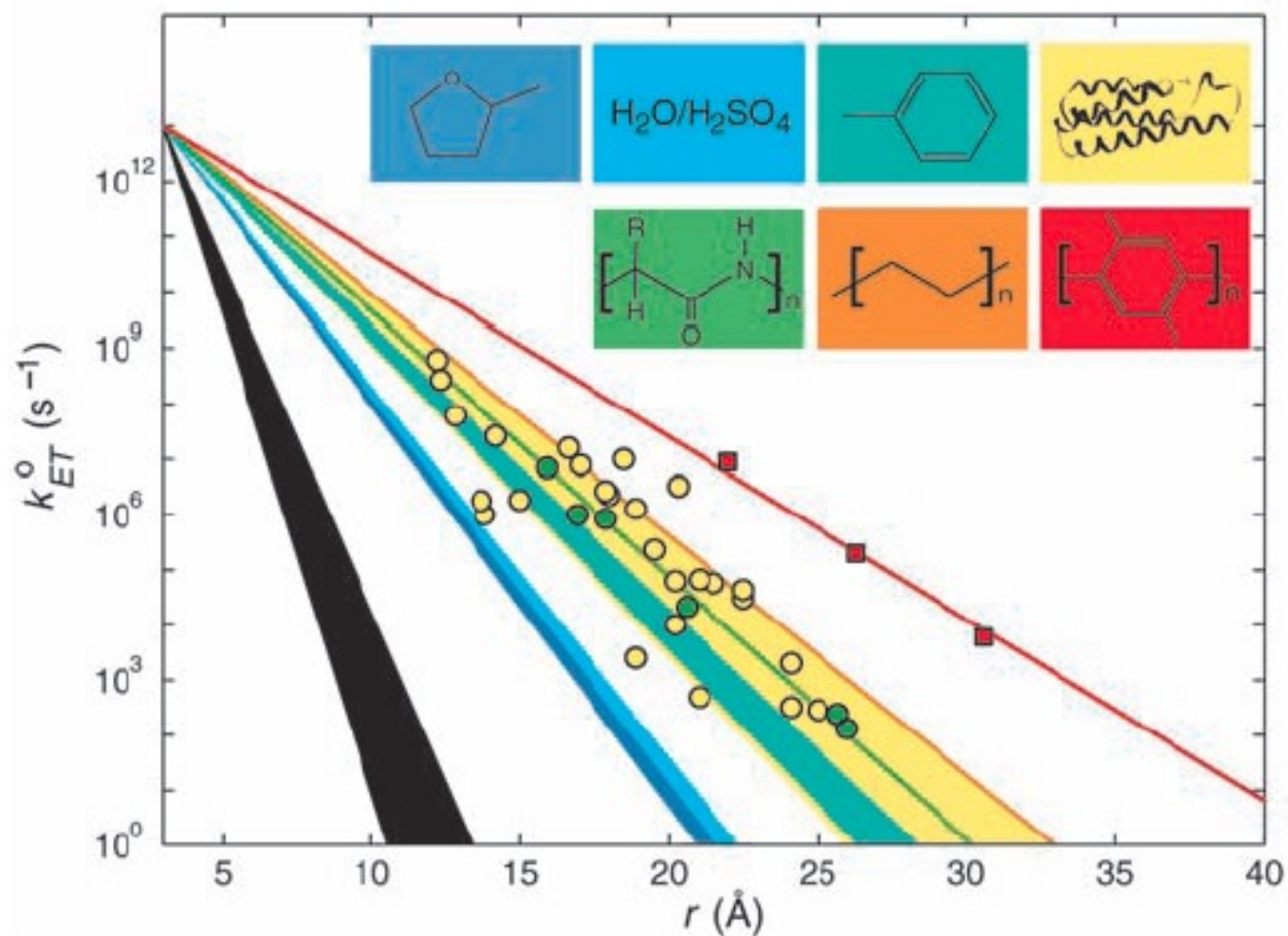

$$k_{CT} = k_0 \exp(-\beta r)$$

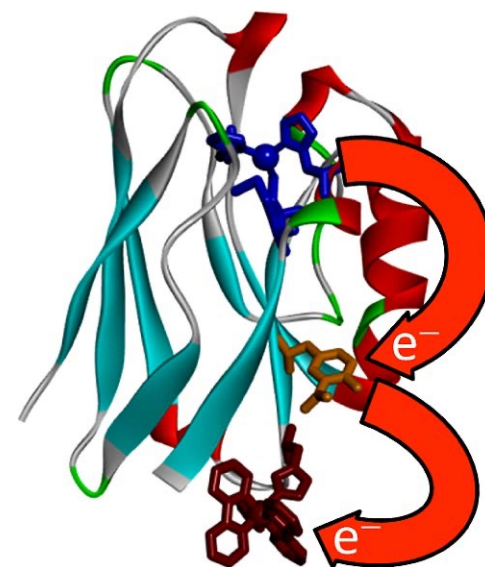

Wenger, Leigh, Villahermosa, Gray, Winkler, *Science*, **2005**; 307, 99-102.

G. Mc Lendon, *Acc. Chem. Res.* **1988**, 21, 160-167

## **DNA-Mediated Photoelectron Transfer Reactions**

Jacqueline K. Barton,\* Challa V. Kumar, and  
Nicholas J. Turro\*

*Department of Chemistry, Columbia University  
New York, New York 10027  
Received April 7, 1986*

*J. Am. Chem. Soc.* **1986**, *108*, 6391-6393



**J. K. Barton**

## **Accelerated Electron Transfer Between Metal Complexes Mediated by DNA**

---

MICHAEL D. PURUGGANAN, CHALLA V. KUMAR,  
NICHOLAS J. TURRO,\* JACQUELINE K. BARTON\*

---



**N. J. Turro**

*Science*, **1988**, *241*, 1645-1649



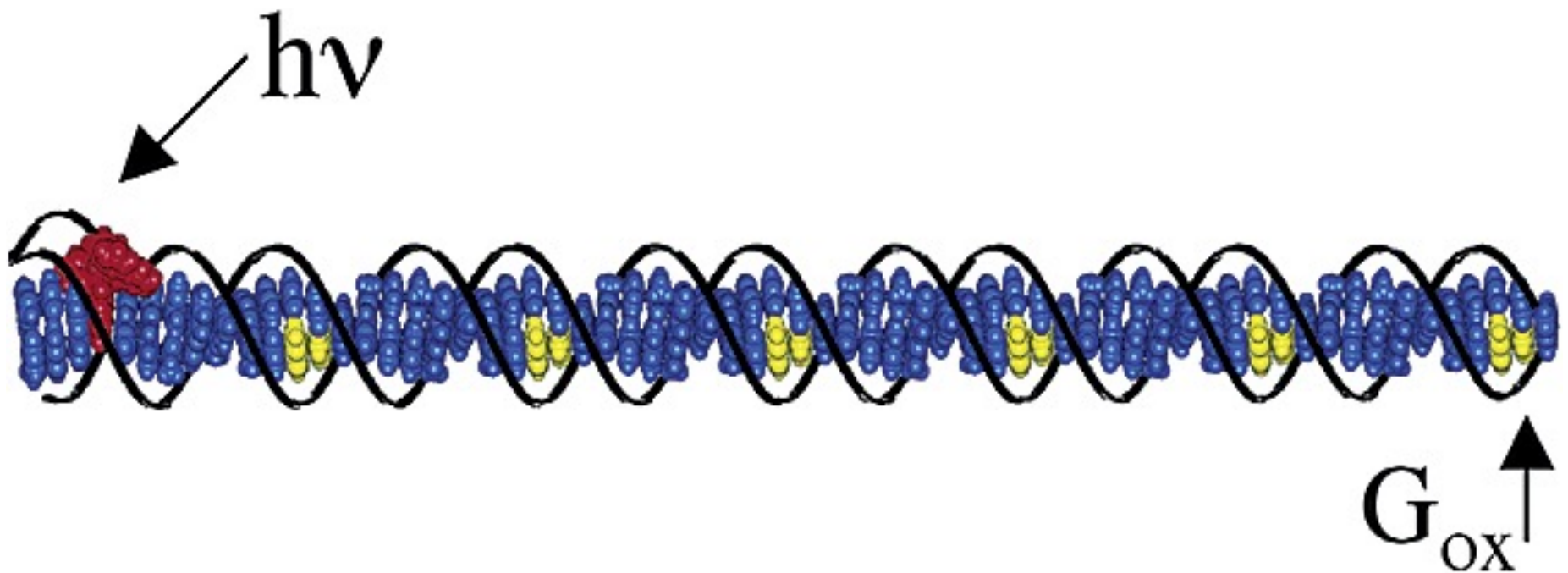

$$k_{CT} = k_0 \exp(-\beta r)$$

$$\beta < 0.2 \text{ /\AA}^\circ$$

e transfer  $> 200 \text{ \AA}$

**DNA is a Molecular Wire**

Schematic representation of a DNA duplex with a tethered rhodium photooxidant containing six 5'-GG-3' guanine doublets up to  $200 \text{ \AA}$  from the metallo-intercalator binding site. Oxidative damage at each of the guanine doublet sites, as a result of photoexcitation of the rhodium intercalator, has been demonstrated.

# Long distance electron transfer in DNA

## Long-range photoinduced electron transfer through a DNA helix

[C.J. Murphy](#), [M.R. Arkin](#), [N.D. Ghatlia](#), [S.H. Bossmann](#), [N.J. Turro](#) and [J.K. Barton](#),  
*Science*, **1993**, 262, 5136

## DNA Is Not a Molecular Wire: Protein-like Electron-Transfer Predicted for an Extended $\pi$ -Electron System

[S. Priyadarshy](#), [S. M. Risser](#) and [D. N. Beratan](#)  
*J. Phys. Chem.* **1996**, 100, 17678-17682

## DNA: insulator or wire?

[D. N. Beratan](#), [S. Priyadarshy](#) and [S. M. Risser](#)  
*Chemistry & Biology*, **1997**, 4, 3-8

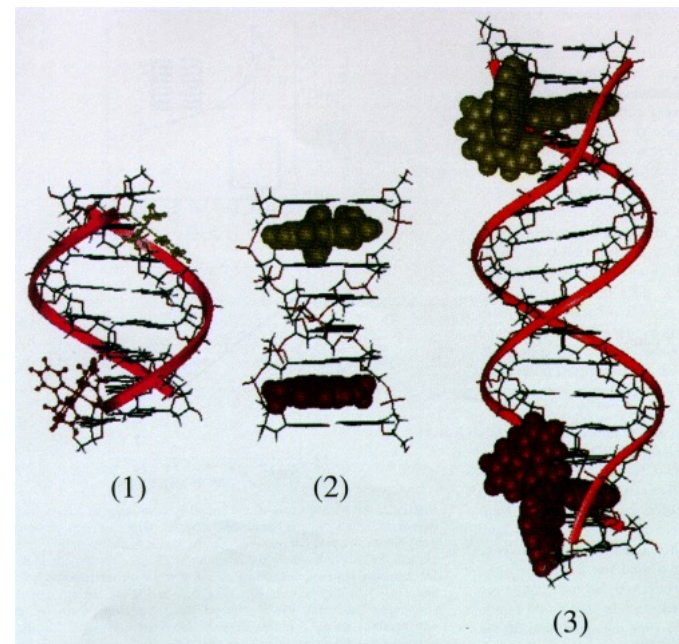



# Electron transfer across a molecular wall

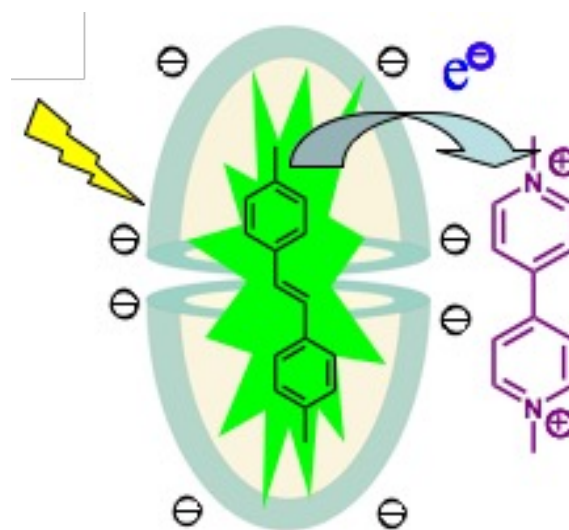
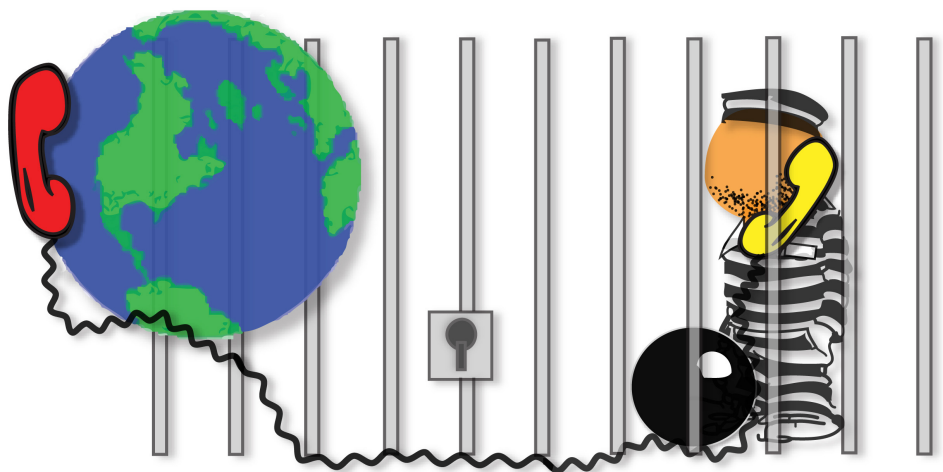

Electron

Plot of  $k_{et}$  vs  $\Delta G^0$  for different donor-acceptor pairs obtained from transient absorption spectroscopy when donor molecules are enclosed within octa acid cavity.

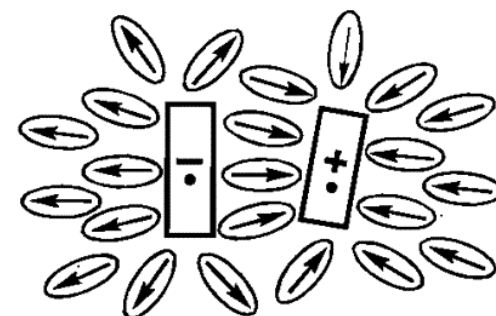
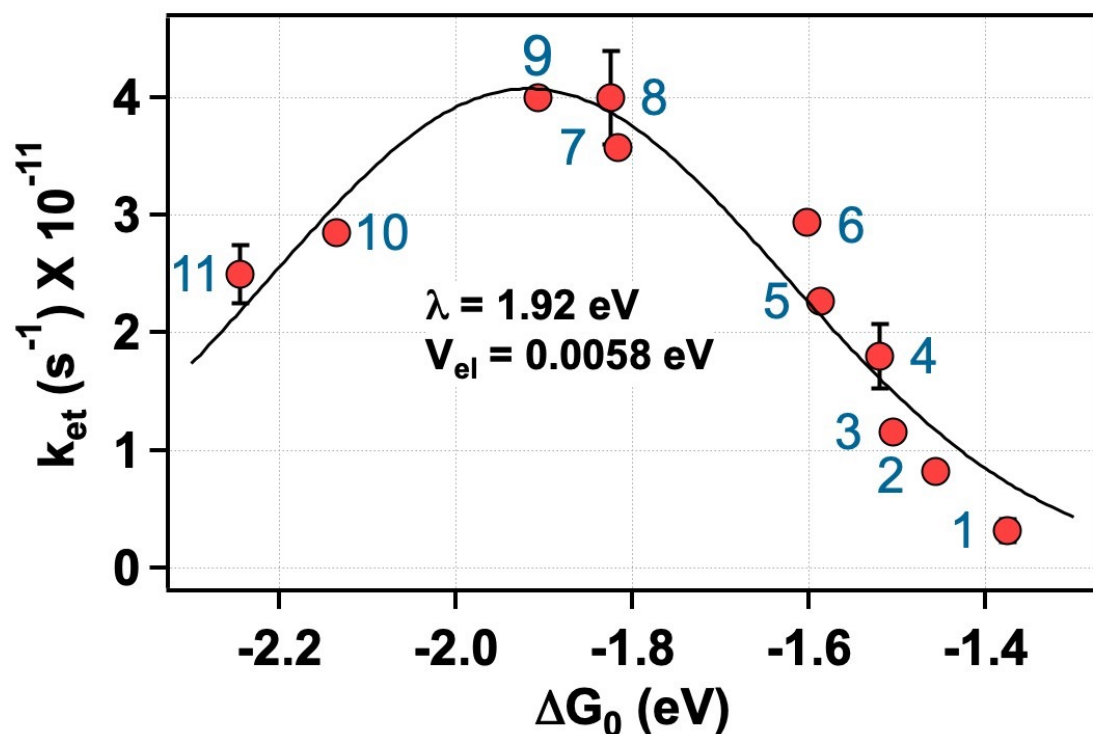

Solvent-Separated Radical-Ion Pair (SSRIP)

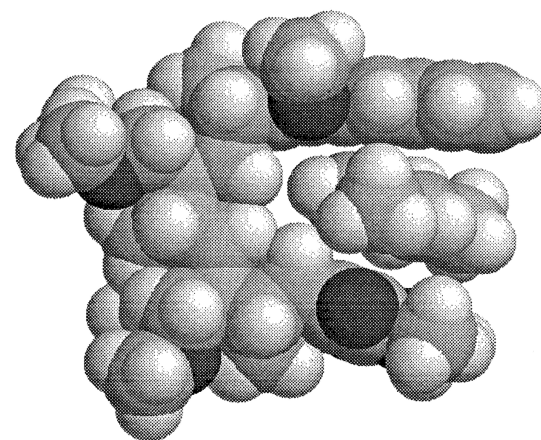



R. Marcus

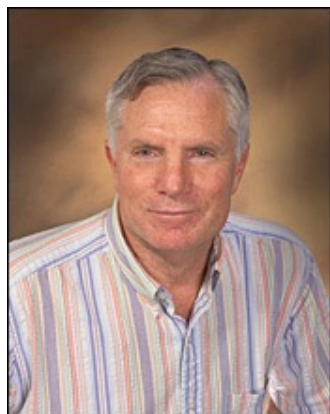

J. Miller



G. Closs



H. Gray



T. Meyer



J. K. Barton



N. J. Turro

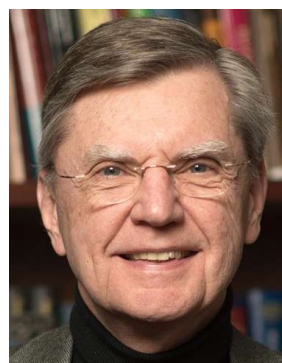

M. Wasielewski



F. D. Lewis

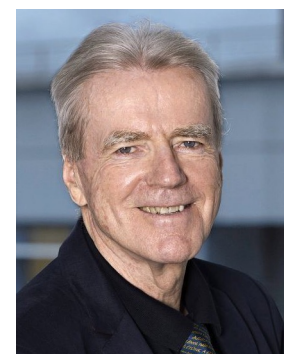

B. Giese



G. Schuster



S. Farid



I. Gould

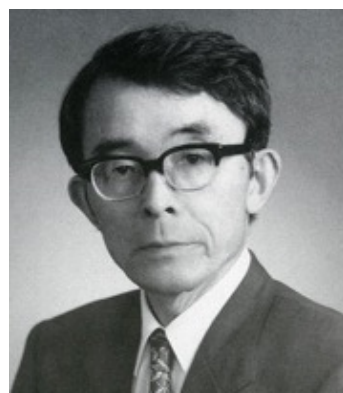

N. Mataga



J. W. Verhoven



M. N. Paddon-Row



D. Gust



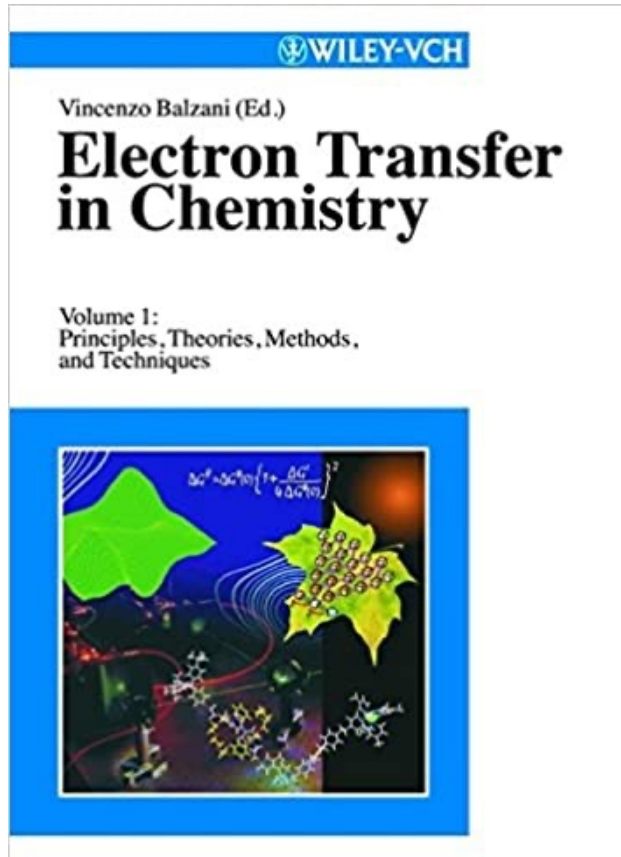

**Balzani V. (Ed.)**  
**Electron Transfer in Chemistry**  
**5 Volume Set**

WILEY-VCH Verlag GmbH, Weinheim,  
Germany, 2001. – 3970 p

**Volume I**  
***Principles and Theories***

**Volume II**  
***Organic Molecules***  
***Organometallic and Inorganic Molecules***

**Volume III**  
***Biological Systems***  
***Artificial Supramolecular Systems***

**Volume IV**  
***Catalysis of Electron Transfer***  
***Heterogeneous Systems***  
***Gas-phase Systems***

**Volume V**  
***Molecular-Level Electronics***  
***Imaging and Information***  
***Energy and the Environment***

WILEY-VCH

Edited by Corey R. J. Stephenson, Tshshik P. Yoon,  
and David W. C. MacMillan

# Visible Light Photocatalysis in Organic Chemistry

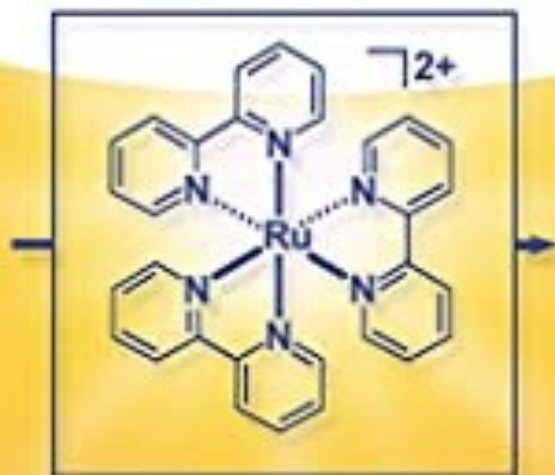

DE GRUYTER

Burkhard König

# CHEMICAL PHOTOCATALYSIS

2ND EDITION

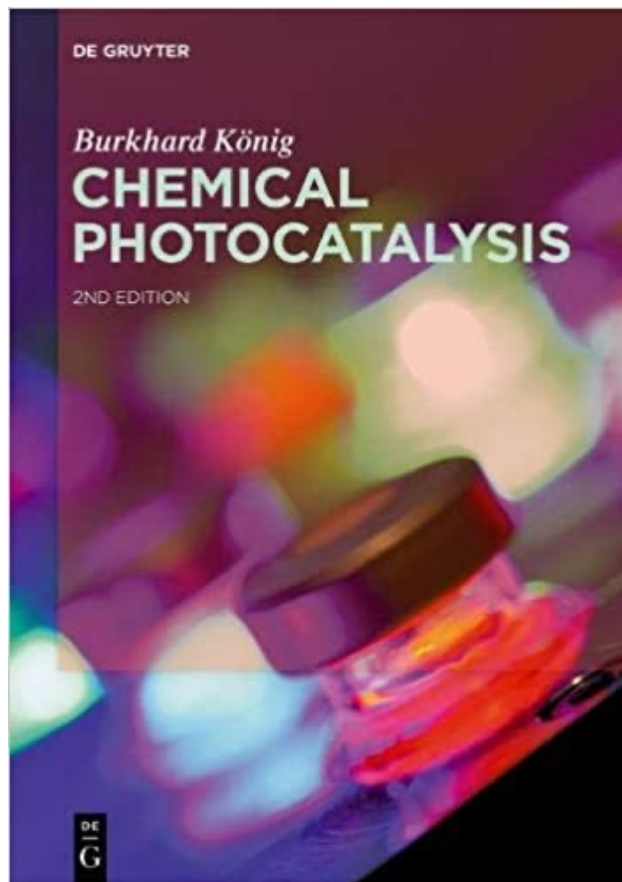

SOS

Science of  
Synthesis

# Photocatalysis in Organic Synthesis

Volume Editor  
B. König



Thieme