

The background of the slide is a dark blue field filled with numerous small, multi-colored dots (yellow, orange, red, green, blue) representing X-ray data points. A prominent, bright yellow and orange circular cluster is centered in the image, indicating a region of high intensity or a specific source of interest.

# X-ray data analysis

Tomáš Plšek

# Literature

---

- [An X-ray Data Primer](#) (20 pages)  
- N.P. Lee & J.C. McDowell
- [Handbook to X-ray astronomy](#)  
- K. Arnaud, R. Smith, A. Sieminigovska
- [High-Resolution X-ray Spectroscopy](#)  
- C. Bambi & J. Jiang
- [Tutorial Guide to X-ray and Gamma-ray Astronomy](#)  
- C. Bambi
- [Rentgenová spektroskopie kosmické pavučiny](#) (bak. práce)  
- Martin Kolář

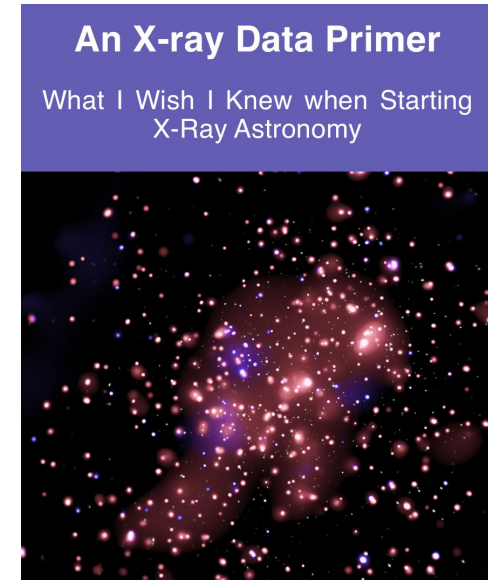

# X-ray Missions & Pipelines

## Chandra X-ray Observatory (1999-now)

- High resolution X-ray imaging
- CCD & grating spectroscopy
- Software: [CIAO](#), [Sherpa](#)

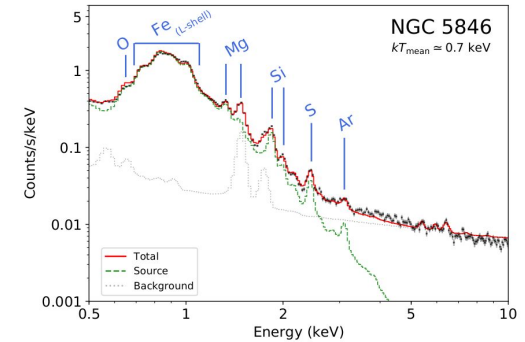
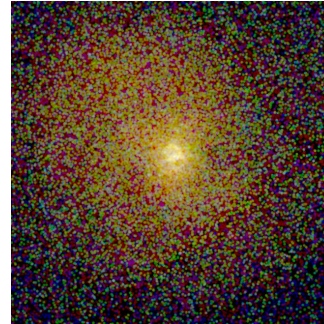

## XMM-Newton (1999-now)

- X-ray imaging (~6 arcsec)
- CCD & grating spectroscopy
- Software: SAS (Science Analysis Software), [eSAS](#)

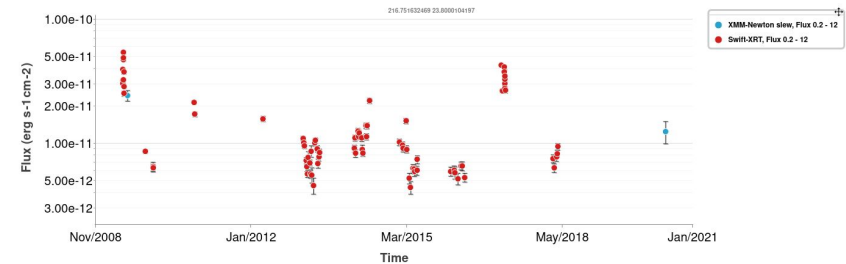

## Swift-XRT (2004-now)

- Long-term monitoring of X-ray point sources
- Software: HEASoft, [Build Swift-XRT Products](#)

## eROSITA (2019-now)

- All-sky survey in the soft X-ray band
- Software: eSASS (eROSITA Science Analysis Software)

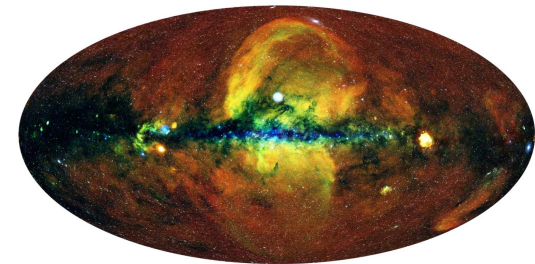

## XRISM (2023-now)

- High-resolution X-ray spectroscopy (microcalorimeters)
- Software: [HEASoft](#), XSlide, FTOOLS

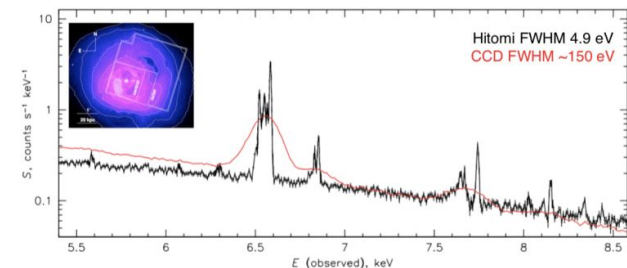

# X-ray observations

---

It is hard to focus X-ray photons - they are energetic enough to penetrate the material  
→ current X-ray telescopes are based on **total reflection** - they are composed of shells of parabolic + hyperbolic metal (Zerodur) mirrors. Baffles are used to prevent stray light or single reflection (only 2 times reflected photons allowed).

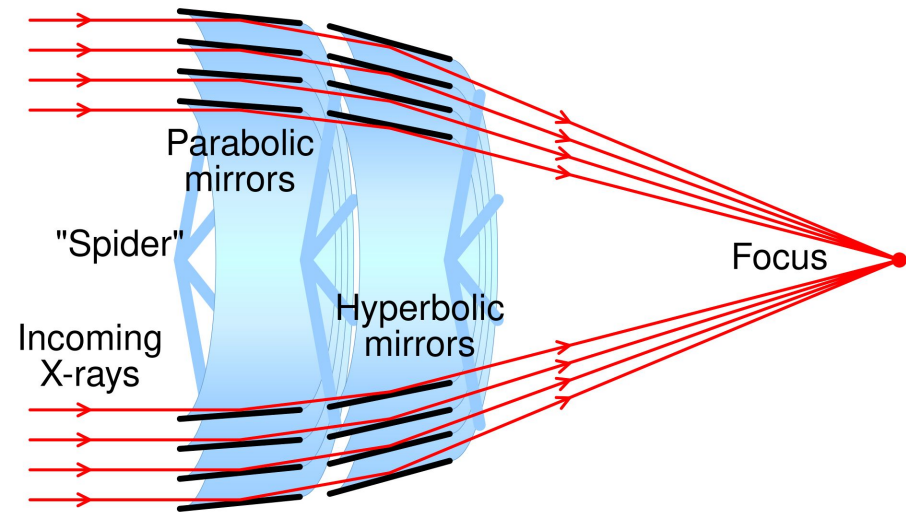
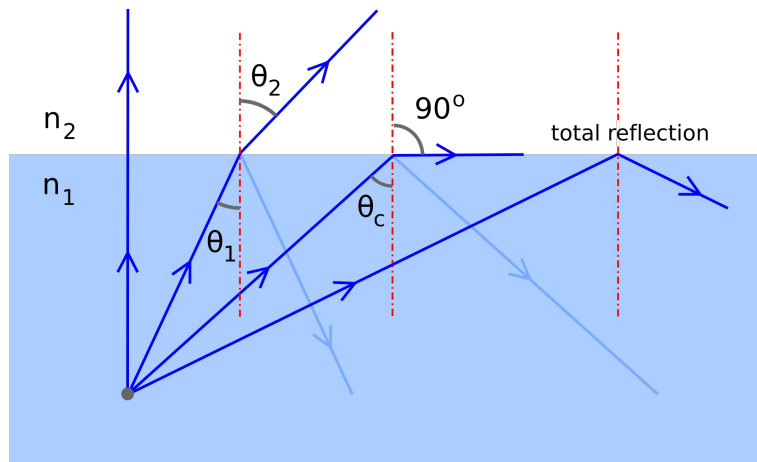

# Chandra X-ray Observatory

- High Resolution Mirror Assembly (**HRMA**)
- multiple detectors
  - **ACIS-S, ACIS-I** - imaging spectrometers
  - front (FI) or back (BI) illuminated chips
  - HRC-S, HRC-I - high resolution cameras
- grating spectroscopy
  - LETG, HETG + ACIS/HRC

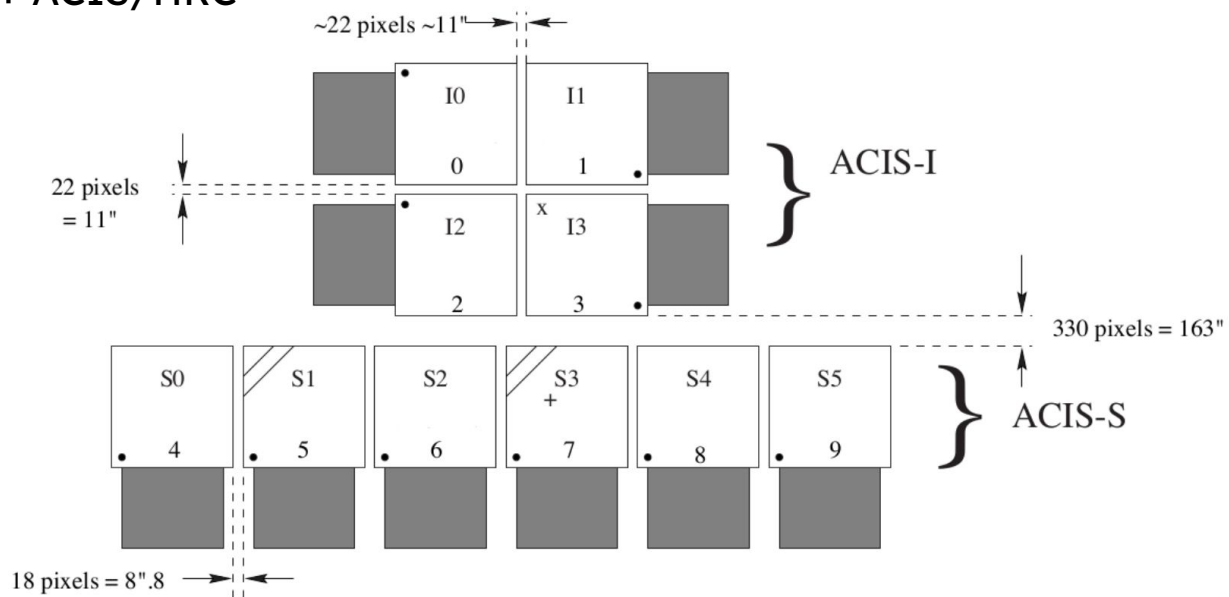
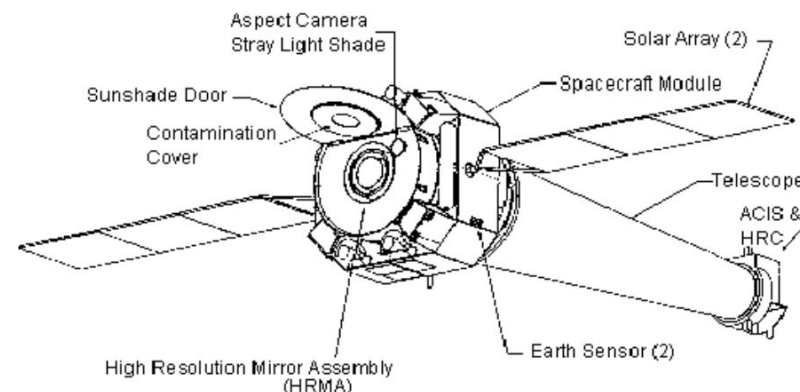

# Chandra data (ACIS-S / ACIS-I)

---

```
$ download_chandra_obsid 785
```

## Secondary

- level 1 event file (evt1.fits)
- aspect solution (aspect folder)
- mask (msk1.fits)
- ...

## Primary

- level 2 event file (evt2.fits)
- image (img2.fits)
- aspect solution (asol1.fits)
- bad pixel map (bpix1.fits)
- FOV (fov1.fits)
- ...

```
plsek@yoga:~/785$ ls *
00README
axaff00785N004_VV001_vv2.pdf
oif.fits

primary:
acisf00785_000N006_bpix1.fits
acisf00785_000N006_fov1.fits
acisf00785N006_cntr_img2.fits
acisf00785N006_cntr_img2.jpg
acisf00785N006_evt2.fits
acisf00785N006_full_img2.fits
acisf00785N006_full_img2.jpg
orbitf072533100N001_eph1.fits
pcadf00785_000N001_asol1.fits

secondary:
acisf00785_000N006_evt1.fits
acisf00785_000N006flt1.fits
acisf00785_000N006_msk1.fits
acisf00785_000N006_mtl1.fits
acisf00785_000N006_stat1.fits
acisf072588591N006_0_bias0.fits
acisf072588591N006_1_bias0.fits
acisf072588591N006_2_bias0.fits
acisf072588591N006_3_bias0.fits
acisf072588591N006_4_bias0.fits
acisf072588591N006_5_bias0.fits
acisf072589898N006_pbk0.fits
aspect
axaff00785N004_VV001_vvref2.pdf.gz
ephem
```

# Reprocessing data

---

```
$ chandra_repro 785 785/repro
```

- reads primary & secondary directories
- produces newly calibrated `evt2`, `asol1`, `bpix1`, `msk1`, `fov1` ... files

```
(ciao-4.16) plsek@yoga:~$ chandra_repro 785 785/repro

Running chandra_repro
version: 07 May 2024

Processing input directory '/home/plsek/785'

No boresight correction update to asol file is needed.
Resetting afterglow status bits in evt1.fits file...

Running the destreak tool on the evt1.fits file...

Running acis_build_badpix and acis_find_afterglow to create a new bad pixel file...

Running acis_process_events to reprocess the evt1.fits file...
Output from acis_process_events:
# acis_process_events (CIAO 4.16.0): The following error occurred 38 times:
    dsAPEPULSEHEIGHTERR -- WARNING: pulse height is less than split threshold when performing
Filtering the evt1.fits file by grade and status and time...
Applying the good time intervals from the flt1.fits file...
The new evt2.fits file is: /home/plsek/785/repro/acisf00785_repro_evt2.fits

Updating the event file header with chandra_repro HISTORY record
Creating FOV file...
Setting observation-specific bad pixel file in local ardlb.par.

Cleaning up intermediate files

WARNING: Observation-specific bad pixel file set for session use:
/home/plsek/785/repro/acisf00785_repro_bpix1.fits
Run 'punlearn ardlb' when analysis of this dataset completed.

Any issues pertaining to data quality for this observation will be listed in the Comments section
/home/plsek/785/repro/axaff00785N004_VV001_vv2.pdf

The data have been reprocessed.
Start your analysis with the new products in
/home/plsek/785/repro
```

```
plsek@yoga:~/785$ ls repro/
785_bkg.fits
acisf00785_000N006_bpix1.fits
acisf00785_000N006_fov1.fits
acisf00785_000N006_msk1.fits
acisf00785_000N006_mtl1.fits
acisf00785_000N006_stat1.fits
acisf00785_asol1.lis
acisf00785_repro_bpix1.fits
acisf00785_repro_evt2.fits
acisf00785_reproflt2.fits
acisf00785_reprofov1.fits
acisf072589898N006_pbk0.fits
axaff00785N004_VV001_vv2.pdf
pcadf00785_000N001_asol1.fits
```

# Event file

= sparse representation of 4D data (X, Y, time, energy)

Select	time	expno	ccd_id	node_id	chipx	chipy	tdetx	tdety	detx	dety	x	y	phas	pha	pha_ro	energy
All	1D	1J	1I	1I	1I	1I	1I	1I	1E	1E	1E	1E	25I	1J	1J	1E
Invert	Modify	Modify	Modify	Modify	Modify	Modify	Modify	Modify	Modify	Modify	Modify	Modify	Modify	Modify	Modify	Modify
1	7,258990994195E+07	3	7	2	751	187	4668	1889	4,626572E+03	4,440944E+03	3,505431E+03	4,118826E+03	Image	648	634	3,026986E+03
2	7,258990994195E+07	3	7	3	971	290	4888	1992	4,846251E+03	4,337587E+03	3,393904E+03	4,334471E+03	Image	2249	2219	1,004338E+04
3	7,258990994195E+07	3	7	3	803	396	4720	2098	4,678043E+03	4,231817E+03	3,591755E+03	4,316136E+03	Image	3149	3088	1,405786E+04
4	7,258990994195E+07	3	7	1	304	400	4221	2102	4,179722E+03	4,228471E+03	3,989365E+03	4,015734E+03	Image	2800	2752	1,311902E+04
5	7,258990994195E+07	3	7	2	521	535	4438	2237	4,396088E+03	4,093807E+03	3,899507E+03	4,254218E+03	Image	2720	2708	1,261197E+04
6	7,258990994195E+07	3	7	1	287	537	4204	2239	4,162673E+03	4,091667E+03	4,086097E+03	4,113963E+03	Image	167	148	8,148401E+02
7	7,258990994195E+07	3	7	1	281	542	4198	2244	4,156678E+03	4,086677E+03	4,093890E+03	4,114278E+03	Image	217	198	1,045535E+03
8	7,258990994195E+07	3	7	2	525	588	4442	2290	4,400692E+03	4,040240E+03	3,928430E+03	4,299540E+03	Image	3493	3464	1,618346E+04
9	7,258990994195E+07	3	7	2	734	597	4651	2299	4,609031E+03	4,031512E+03	3,768355E+03	4,433171E+03	Image	1841	1807	8,535619E+03
10	7,258990994195E+07	3	7	1	265	608	4182	2310	4,140391E+03	4,020502E+03	4,147064E+03	4,156904E+03	Image	1868	1813	8,760751E+03
11	7,258991002403E+07	3	6	0	195	999	3070	2701	3,027353E+03	3,630631E+03	5,267674E+03	3,789453E+03	Image	4012	3593	1,586181E+04
12	7,258991318294E+07	4	7	3	911	133	4828	1835	4,785658E+03	4,494786E+03	3,346184E+03	4,172434E+03	Image	1484	1466	6,607399E+03
13	7,258991318294E+07	4	7	3	870	159	4787	1861	4,745455E+03	4,468465E+03	3,394105E+03	4,168877E+03	Image	2712	2662	1,208457E+04
14	7,258991318294E+07	4	7	1	363	353	4280	2055	4,238297E+03	4,275746E+03	3,913899E+03	4,013429E+03	Image	3622	3568	1,695988E+04
15	7,258991318294E+07	4	7	1	486	442	4403	2144	4,361173E+03	4,186154E+03	3,870844E+03	4,159277E+03	Image	1280	1259	6,022487E+03
16	7,258991318294E+07	4	7	1	273	541	4190	2243	4,148690E+03	4,087680E+03	4,099404E+03	4,108224E+03	Image	197	179	9,538903E+02
17	7,258991318294E+07	4	7	1	274	552	4191	2254	4,150057E+03	4,076694E+03	4,105000E+03	4,117776E+03	Image	251	226	1,205806E+03
18	7,258991318294E+07	4	7	0	103	597	4020	2299	3,978893E+03	4,031847E+03	4,268147E+03	4,049281E+03	Image	169	153	7,817990E+02
19	7,258991318294E+07	4	7	1	270	601	4187	2303	4,145662E+03	4,027387E+03	4,138475E+03	4,154244E+03	Image	172	154	8,367358E+02
20	7,258991318294E+07	4	7	2	571	608	4488	2310	4,446247E+03	4,020170E+03	3,904255E+03	4,342776E+03	Image	47	42	2,526535E+02
21	7,258991318294E+07	4	7	2	571	616	4488	2318	4,446243E+03	4,012625E+03	3,908847E+03	4,348763E+03	Image	26	21	1,585577E+02
22	7,258991318294E+07	4	7	0	141	660	4058	2362	4,016807E+03	3,968913E+03	4,276324E+03	4,122298E+03	Image	417	396	1,884580E+03
23	7,258991318294E+07	4	7	1	310	750	4227	2452	4,185529E+03	3,878946E+03	4,197104E+03	4,296324E+03	Image	2237	2198	1,048607E+04
24	7,258991318294E+07	4	7	0	202	783	4119	2485	4,077289E+03	3,846419E+03	4,302809E+03	4,256317E+03	Image	3737	3664	1,667485E+04
25	7,258991318294E+07	4	7	2	663	875	4580	2577	4,537980E+03	3,753544E+03	3,993587E+03	4,610216E+03	Image	3183	3128	1,471442E+04
26	7,258991318294E+07	4	7	1	303	915	4220	2617	4,178718E+03	3,714441E+03	4,302556E+03	4,422768E+03	Image	2644	2591	1,238569E+04
27	7,258991318294E+07	4	7	3	854	997	4771	2699	4,729048E+03	3,632386E+03	3,915598E+03	4,822592E+03	Image	604	560	2,717772E+03
28	7,258991326502E+07	4	6	3	1018	319	3893	2021	3,849794E+03	4,309428E+03	4,201814E+03	3,750420E+03	Image	218	192	8,429230E+02
29	7,258991642393E+07	5	7	0	161	185	4078	1887	4,036651E+03	4,443253E+03	3,971891E+03	3,757420E+03	Image	2036	2031	9,173027E+03
30	7,258991642393E+07	5	7	2	712	192	4629	1894	4,587648E+03	4,436344E+03	3,538703E+03	4,097999E+03	Image	3330	3278	1,540151E+04
31	7,258991642393E+07	5	7	2	669	225	4586	1927	4,544696E+03	4,403419E+03	3,592822E+03	4,098014E+03	Image	2306	2266	1,067495E+04
32	7,258991642393E+07	5	7	1	312	269	4229	1971	4,187406E+03	4,359663E+03	3,903055E+03	3,915458E+03	Image	2964	2569	1,388397E+04
33	7,258991642393E+07	5	7	3	802	333	4719	2035	4,677078E+03	4,294743E+03	3,553828E+03	4,264791E+03	Image	229	212	1,054719E+03
34	7,258991642393E+07	5	7	2	682	336	4599	2038	4,557240E+03	4,291811E+03	3,650740E+03	4,194238E+03	Image	208	193	9,986478E+02
35	7,258991642393E+07	5	7	2	546	378	4463	2080	4,421780E+03	4,250689E+03	3,783279E+03	4,144500E+03	Image	2737	2662	1,267978E+04
36	7,258991642393E+07	5	7	0	138	394	4055	2096	4,014326E+03	4,234551E+03	4,116537E+03	3,909515E+03	Image	207	191	9,480716E+02
37	7,258991642393E+07	5	7	0	144	453	4061	2155	4,019913E+03	4,175246E+03	4,148169E+03	3,959989E+03	Image	2598	2562	1,160061E+04
38	7,258991642393E+07	5	7	1	396	536	4313	2238	4,271524E+03	3,998692E+03	3,998692E+03	4,178608E+03	Image	2843	2819	1,331634E+04
39	7,258991642393E+07	5	7	1	287	542	4204	2244	4,162291E+03	4,086674E+03	4,089013E+03	4,116887E+03	Image	327	300	1,561434E+03



# Aspect solution

= orientation of telescope vs time

- based on Aspect Camera
  - optical **astrometry**
- aspect solution (`asol1` file)
  - dither pattern
  - Lissajous figures
- level 0 → level 1 event file
  - [data levels](#)

Aspect Solution – Optical–Axis Dither Over the Sky

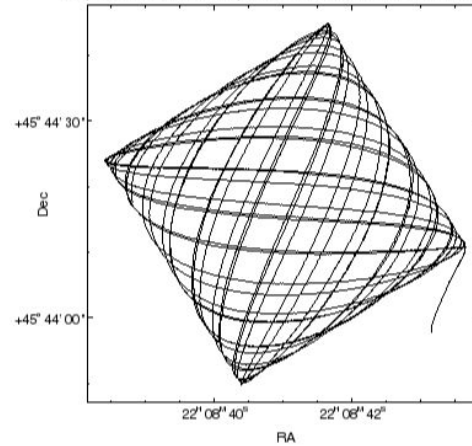

Aspect Solution – Optical–Axis Dither Over Time

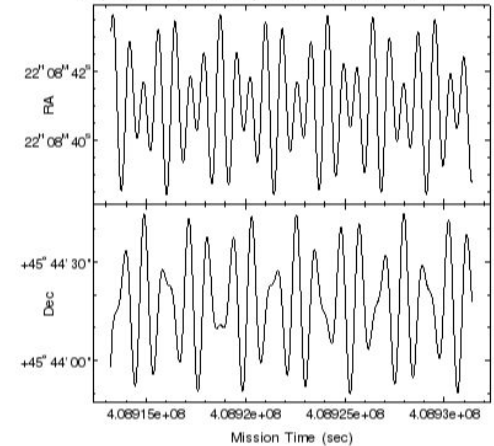

Observed Source on the Chandra/HRC–I Detector

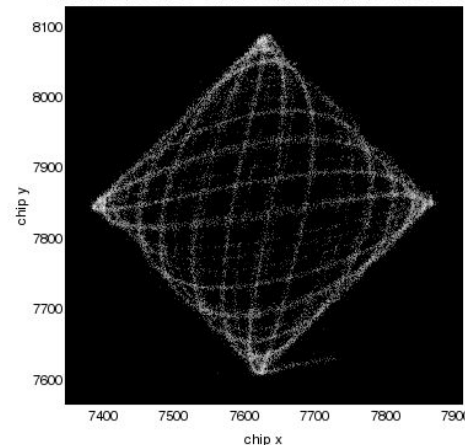

Observed Source on the Sky with Chandra/HRC–I

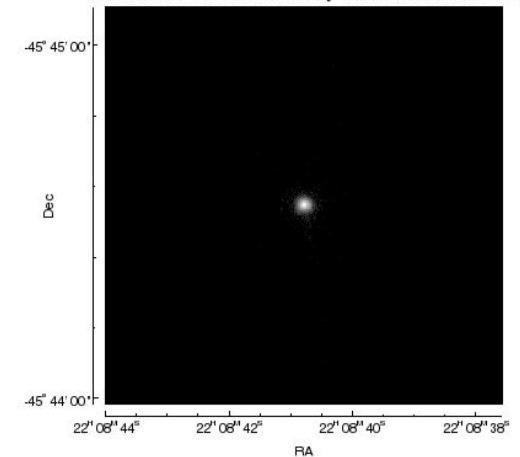

# Instrument & Exposure map

---

```
$ mkinstmap outfile=instmap.fits monoenergy=1.5 obsfile=evt.fits ...
```

```
$ mkexpmap asphist.fits outfile=expmap.fits instmapfile=instmap.fits ...
```

instrument map (bad pixels / rows)

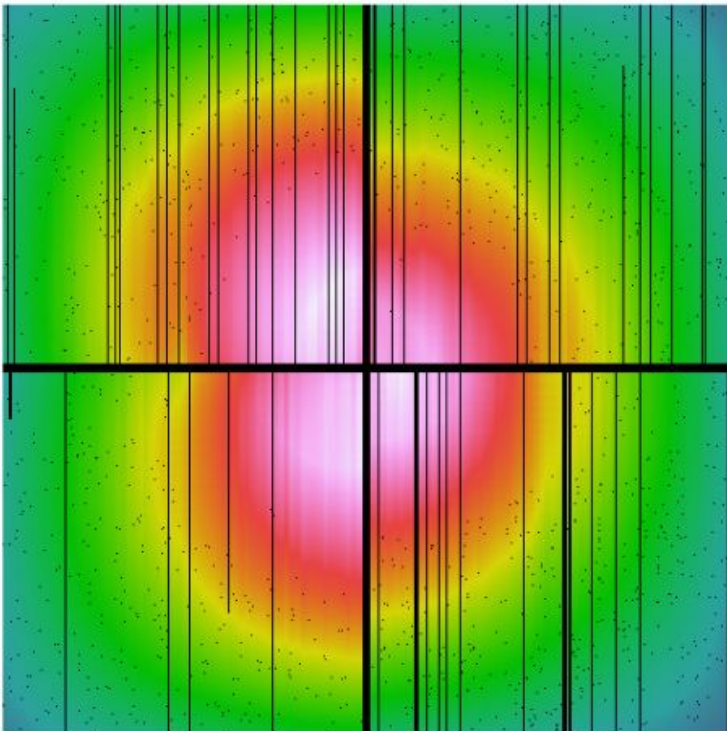

exposure map (total exposure time)

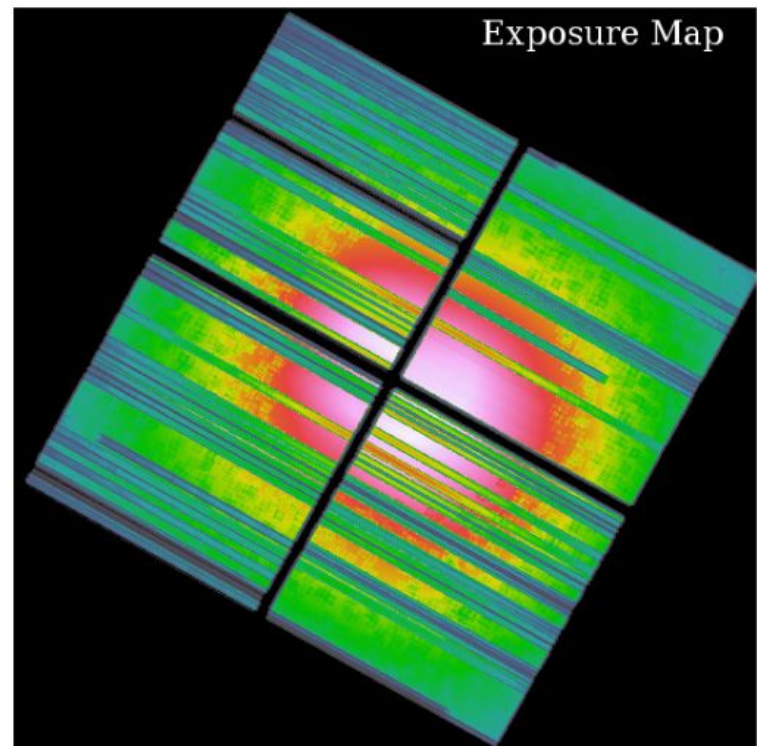

# Exposure correction

---

```
$ fluximage 782_evt.fits ...
```

→ expmap & flux image for OBSID

```
$ flux_obs */*_evt.fits ...
```

→ merged expmap, merged flux image

```
$ dmingcalc "merged.img,expmap.fits" none opt="img1/img2" outfile=expcor.img
```

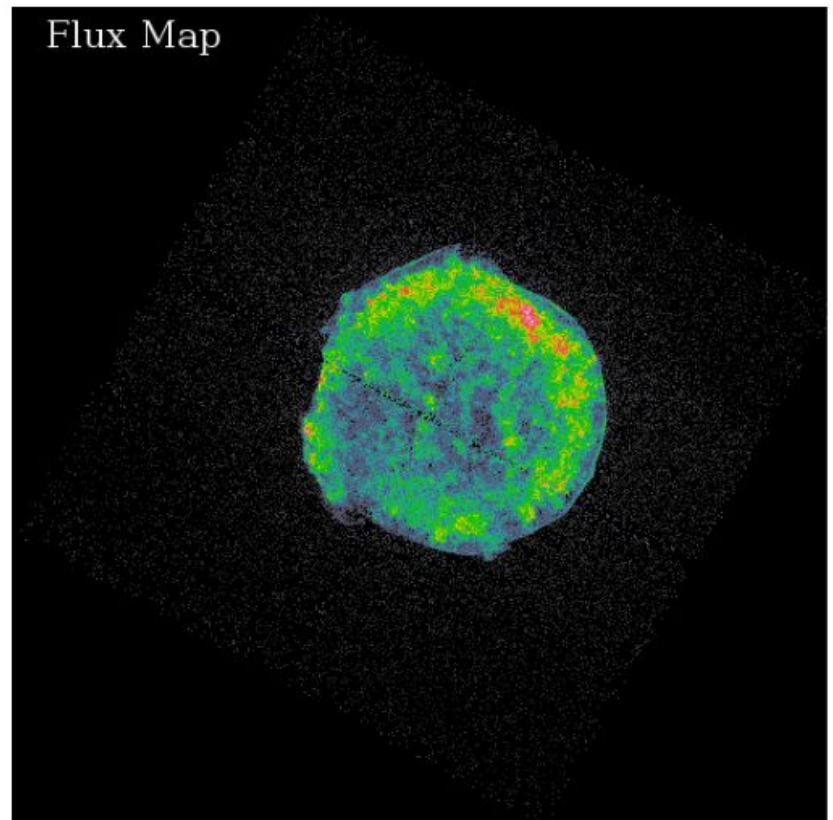
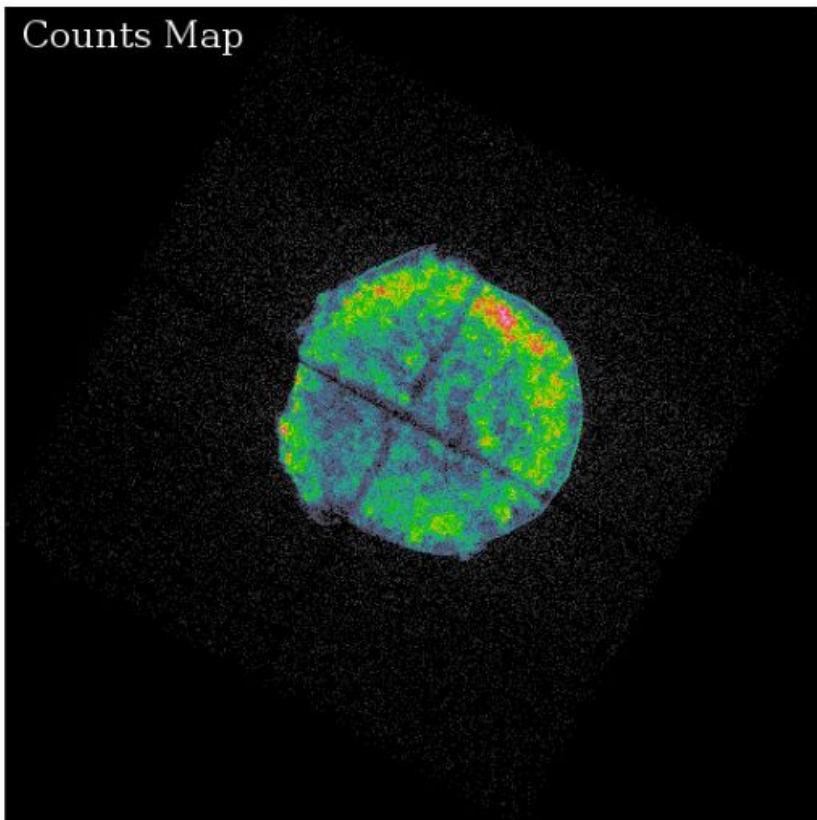

# Point Spread Function (PSF)

= response of telescope to point-like emission

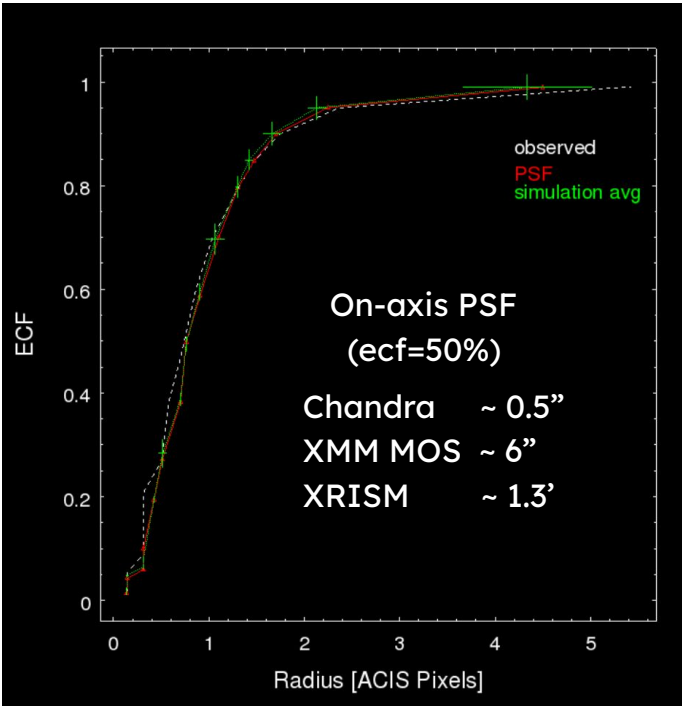
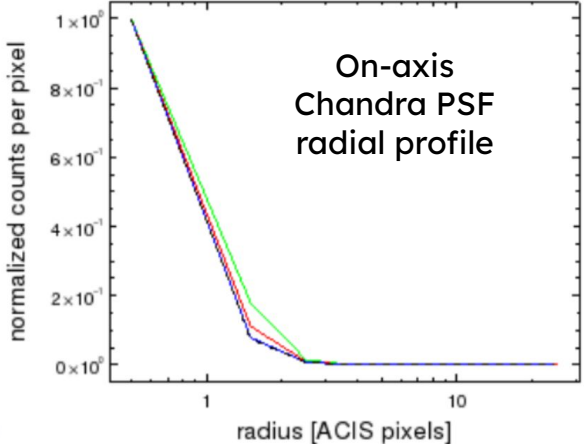
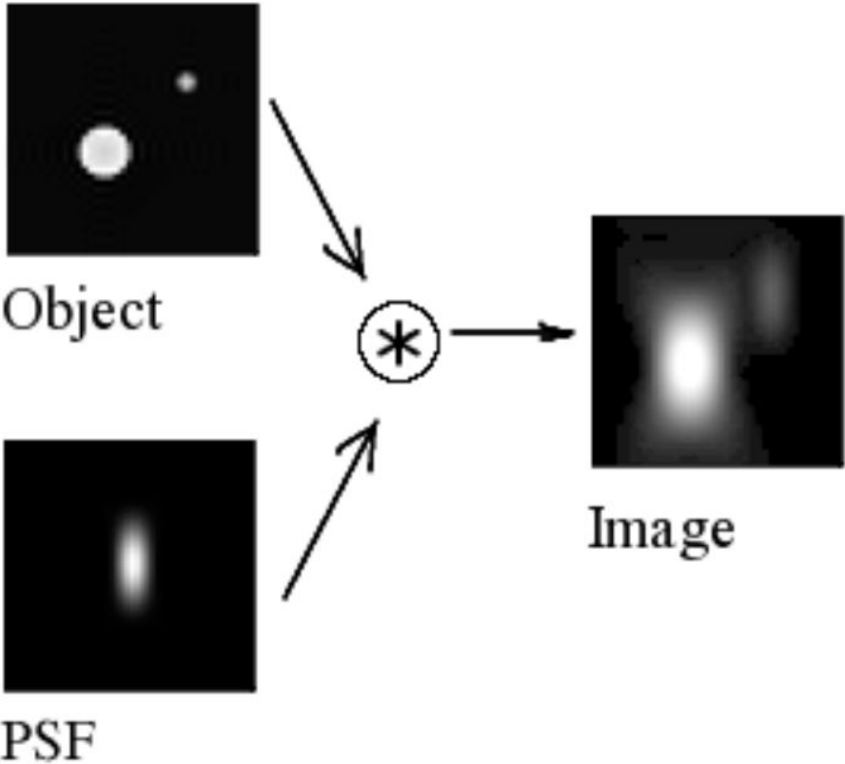

# Chandra (HRMA) PSF

spatial dependence (Chandra)

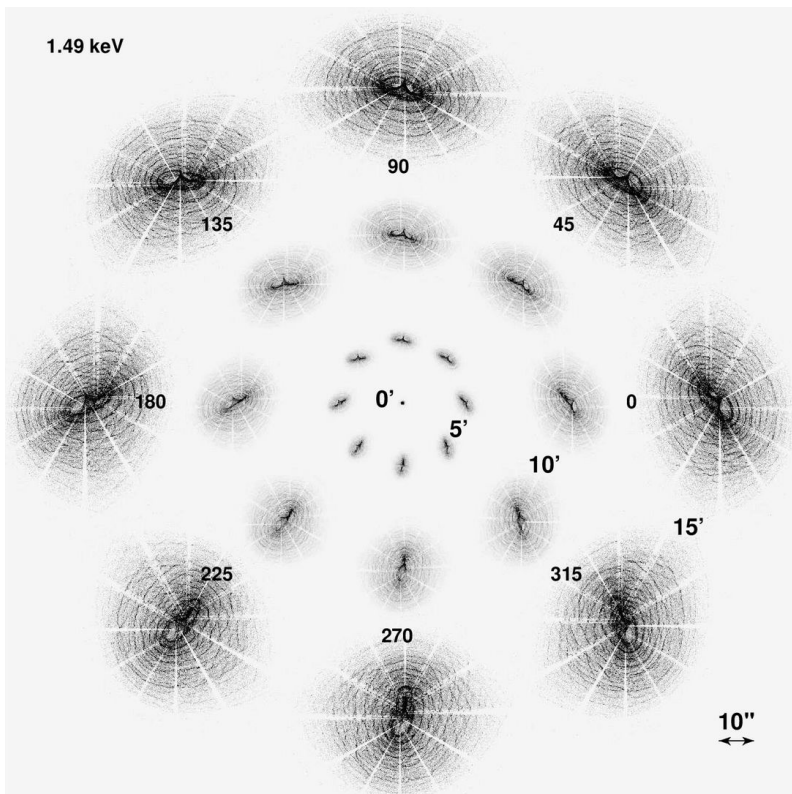

energy dependence (Chandra)

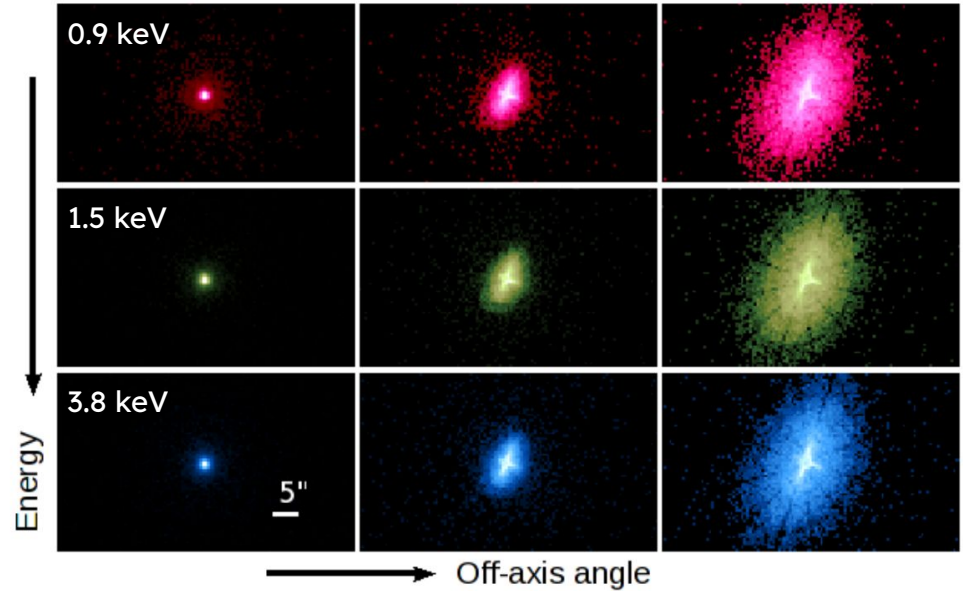

# On-axis PSF treatment

---

PSF for any given position, energy and time will be different - real PSF will also differ from ground measurements. Best way to treat PSF is to perform a simulation (e.g. using [MARX](#)).

```
$ srcflux ... psfmethod='ideal | quick | arfcorr | psffile'
```

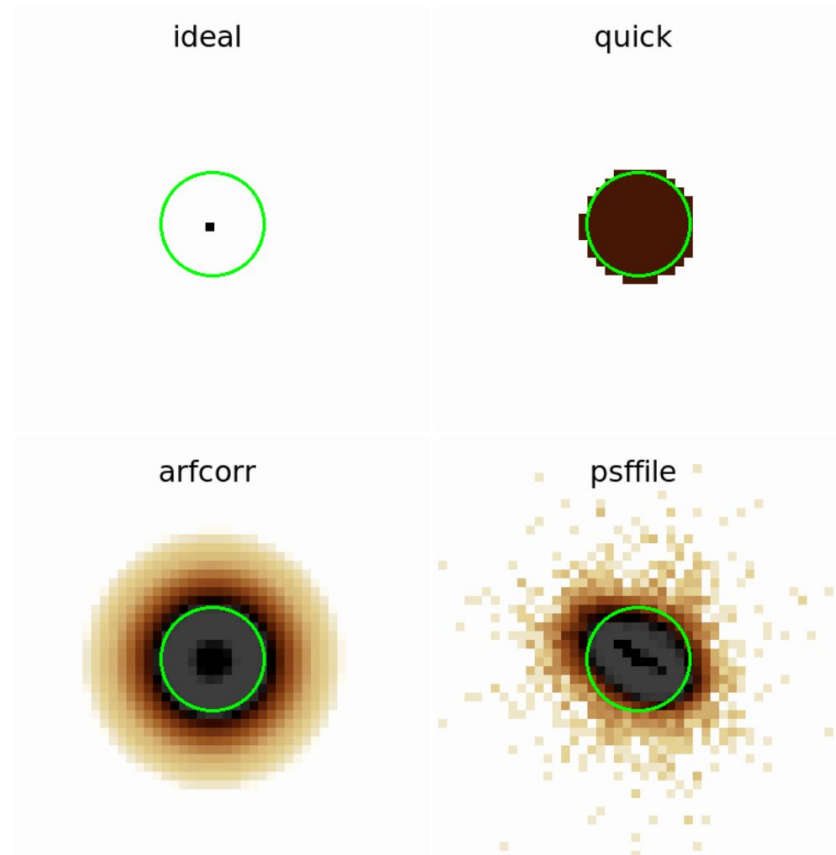

# Off-axis PSF treatment (psfmap)

---

\$ fluximage 782\_evt.fits psfecf=0.9 ... → inc. psfmap for OBSID

\$ flux\_obs \*/\*\_evt.fits psfecf=0.9 ... → inc. merged psfmap

\$ mkpsfmap acis\_img.fits acis\_psf.fits energy=1.5 ecf=0.9

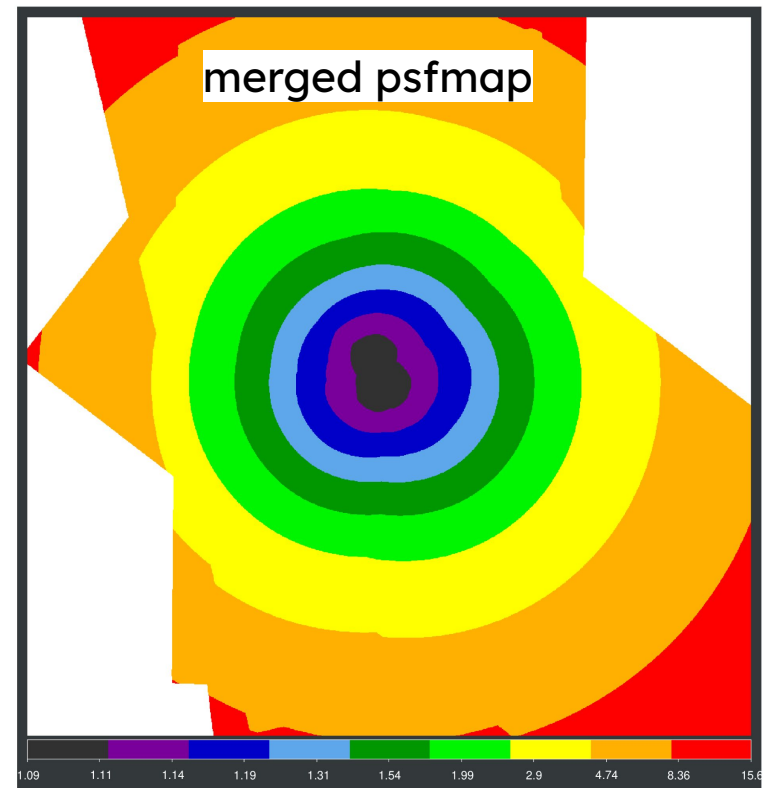
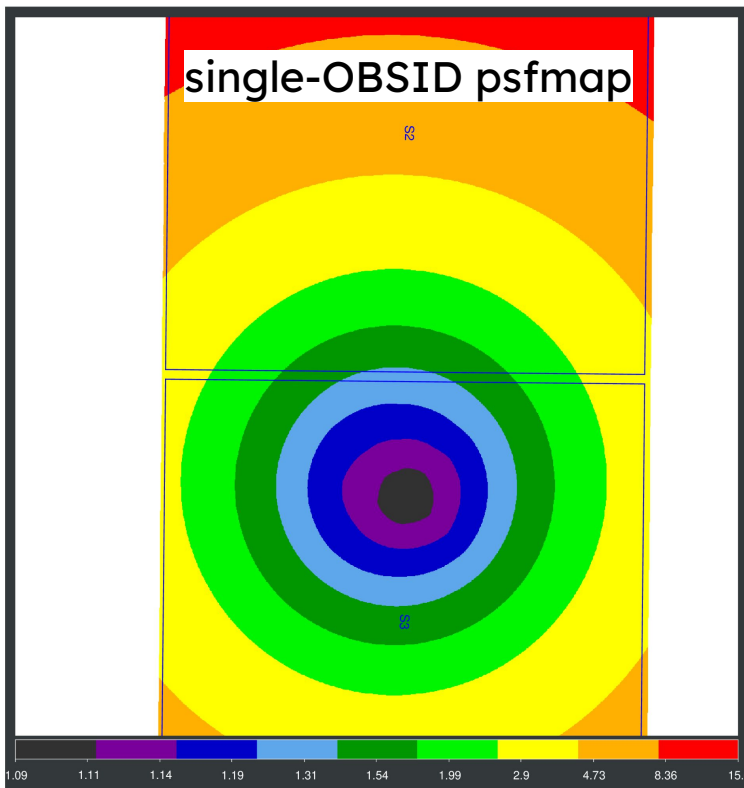

# Point source detection

---

```
$ wavdetect evt.fits ... scales="2 4 8" sigthresh=1e-5 psffile=psfmap.fits
```

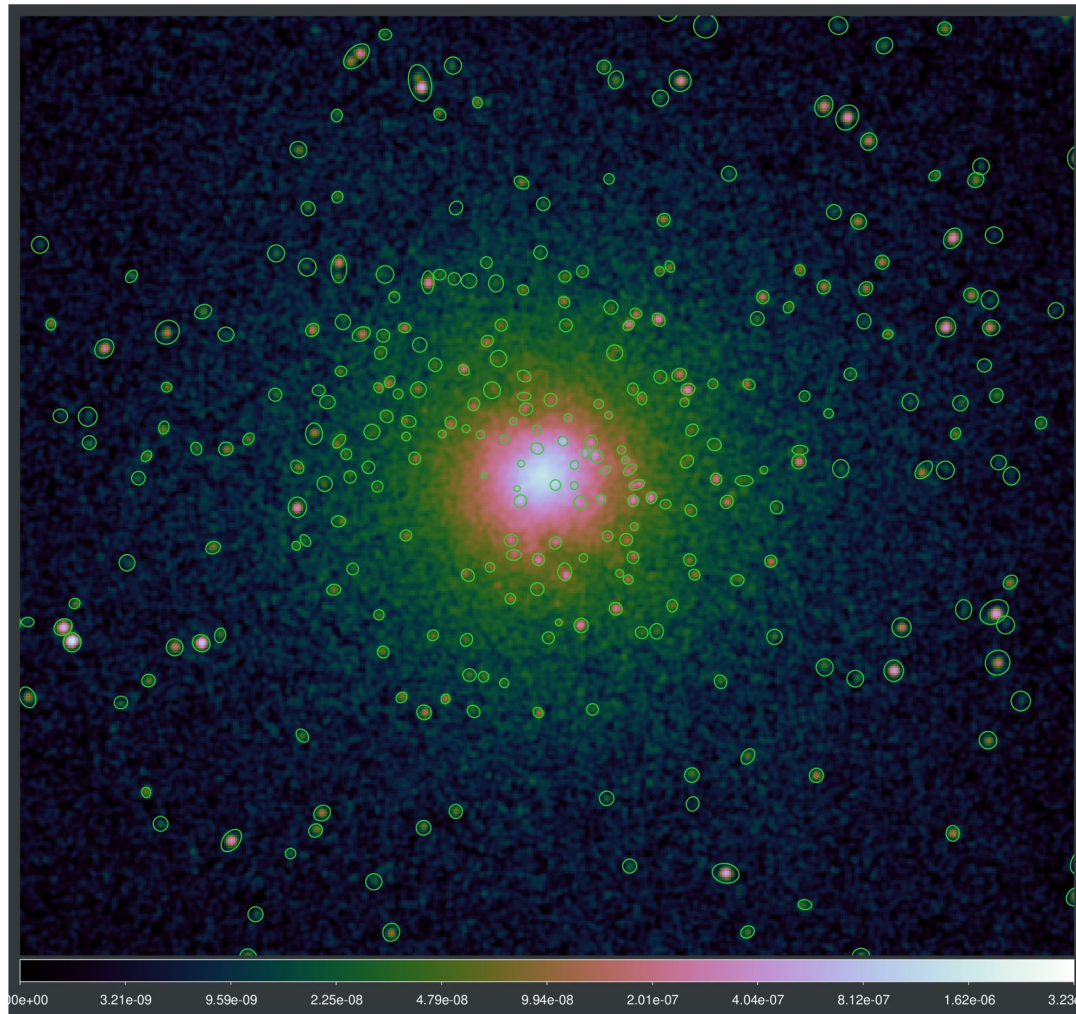



# Filling point sources

---

```
$ flux_obs */*evt.fits outroot=rgb bands=broad bin=1
```

```
$ dmfilth broad.img broad_filled.img src.reg bkg.reg method=POISSON
```

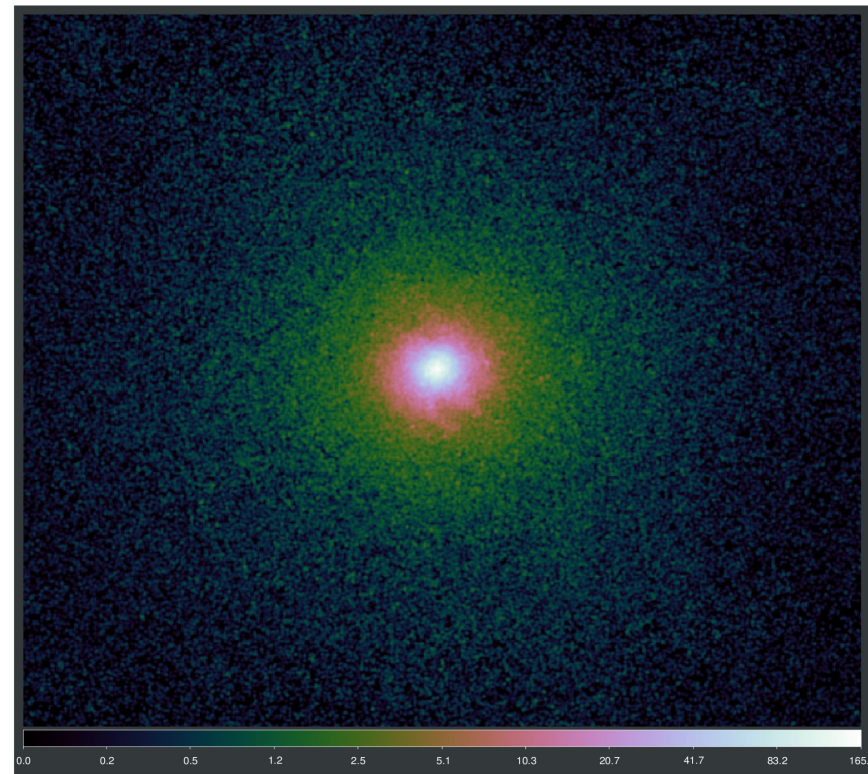
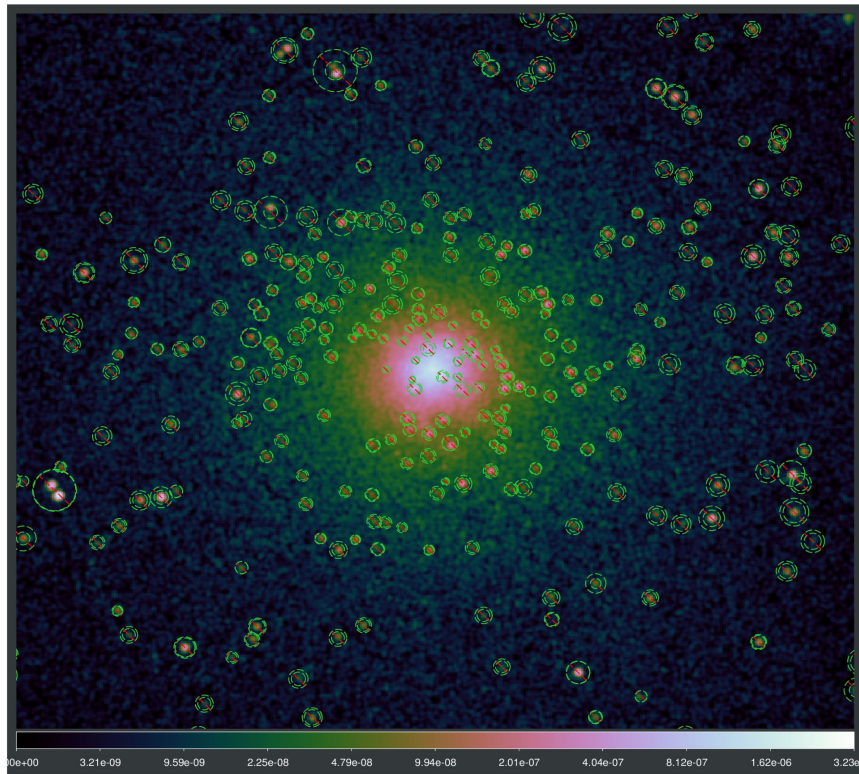

# Blanksky vs Stowed background

```
$ blanksky evt.fits bkg.fits asol.fits stowedbg='yes | no'
```

- can be used for image / spectral subtraction
- based on calibration files, scaled to match 9-12 keV

inst.    inst. + CXB

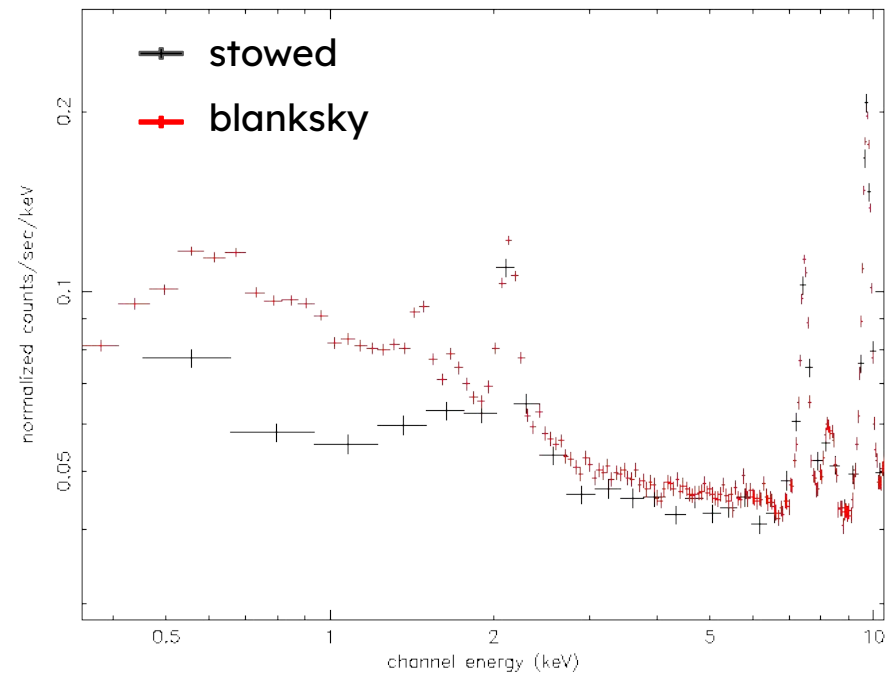
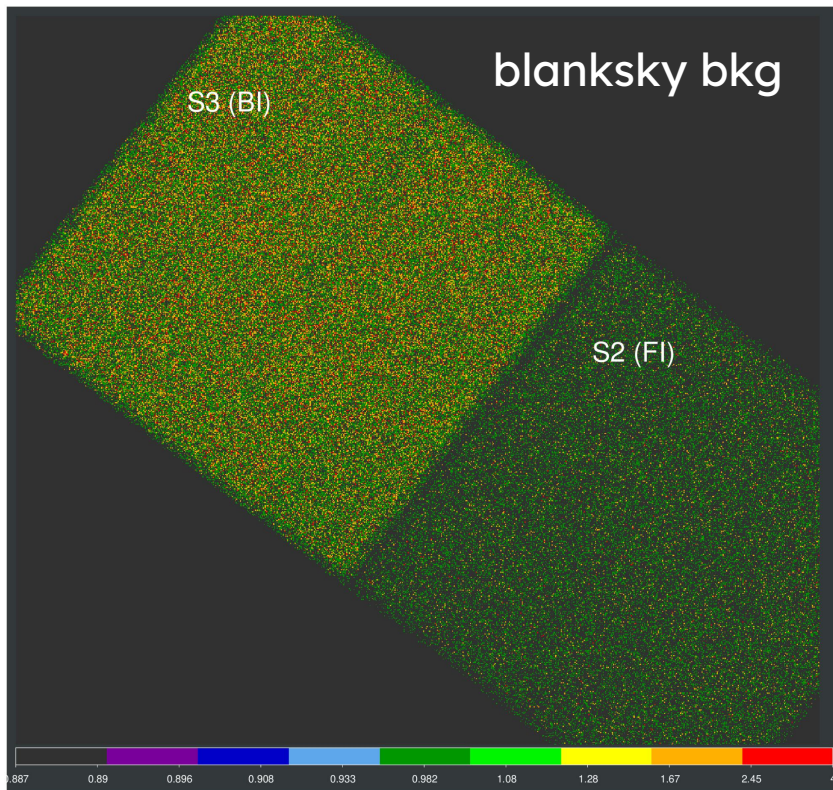

# Contaminations and Defects

- soft protons (due to Solar activity)
  - background lightcurve
  - deflaring algorithm
  - Good Time Intervals (GTI)
- [pile-up](#) - when source is too bright
  - two photons arriving at same time
  - lowers count rate
  - makes spectrum harder
  - [PIMMS](#) - tool to estimate pile-up
- contamination of ACIS chips
  - molecular contamination (frozen water)
  - decreases effective area in the soft band

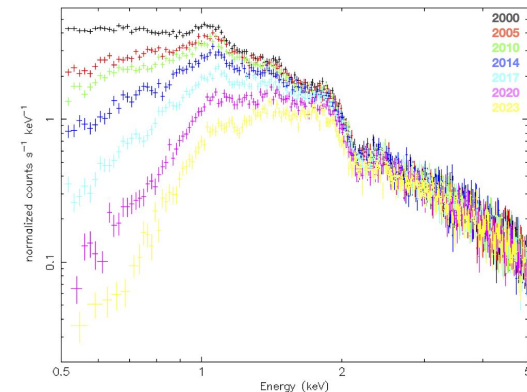
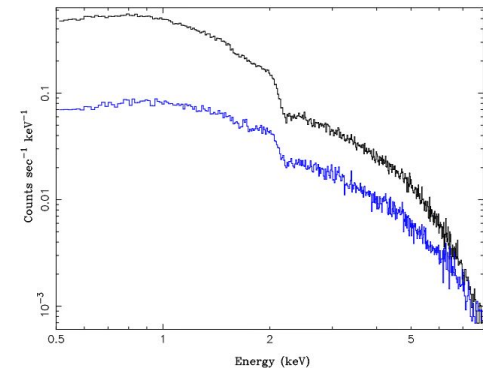
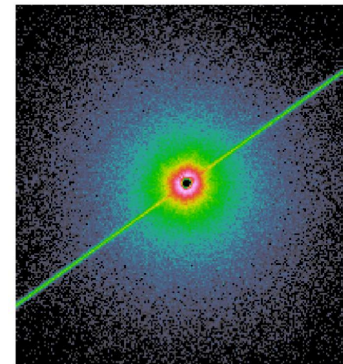
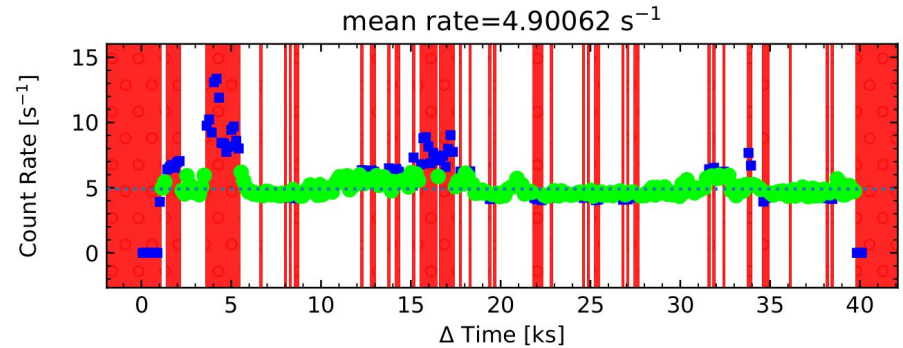

# Image analysis

```
$ flux_obs */*evt.fits outroot=merged bands=broad bin=1
```

- Beta modelling (see next slide)
- Gaussian Gradient Magnitude ([GGM](#)) filter
- Unsharp masking
- Surface Brightness Fluctuations ([Churazov](#), [Dupourqué](#))
- Cavity detection ([CADET](#))

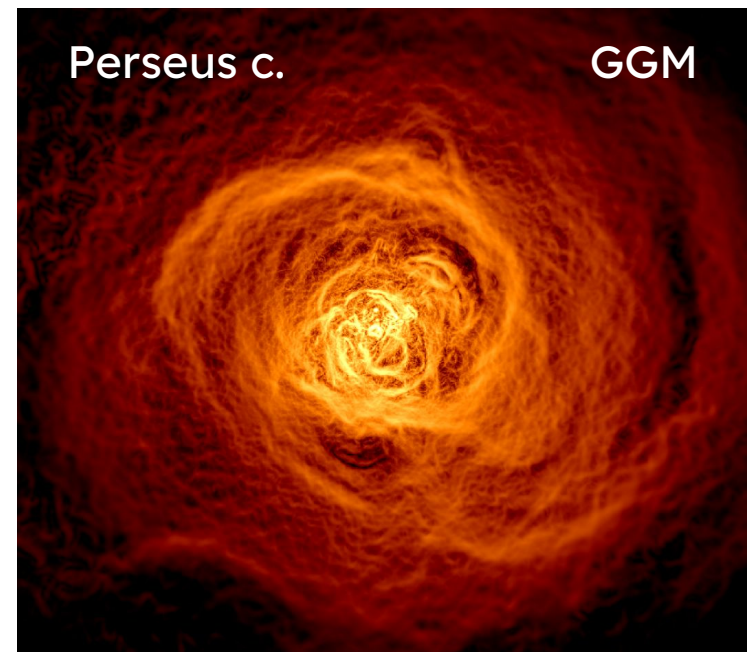
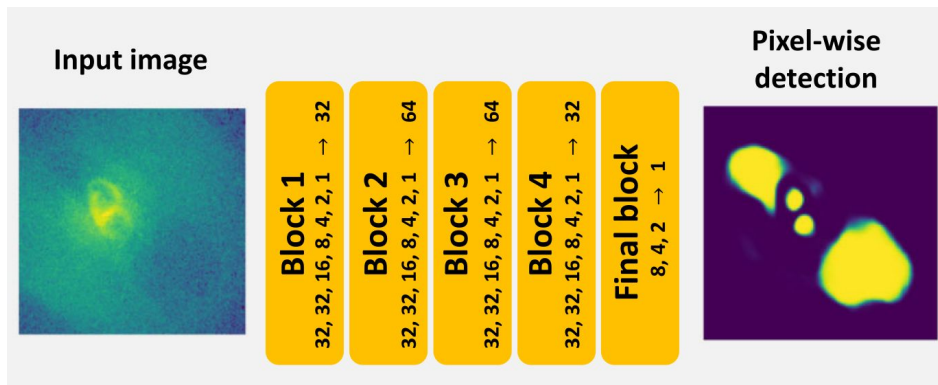

# Beta modelling

Galaxy:  Original scale: 256 x 256  
Model:  Scale:

**Beta2d.b1** **Const2d.bkg**

X0   freeze    c0   freeze  
Y0   freeze  
ellip   freeze  
theta   freeze  
r0   freeze  
ampl   freeze  
alpha   freeze

Method:  Chain length:   
Statistic:  Chain burn:

$$\rho_{\text{gas}}(r) = \rho_0 \left[ 1 + \left( \frac{r}{r_0} \right)^2 \right]^{-3\beta/2}$$

$$S(r) = n_0^2 \Lambda(T) r_0 B(3\beta - 0.5, 0.5) \left[ 1 + \left( \frac{r}{r_0} \right)^2 \right]^{0.5-3\beta}$$

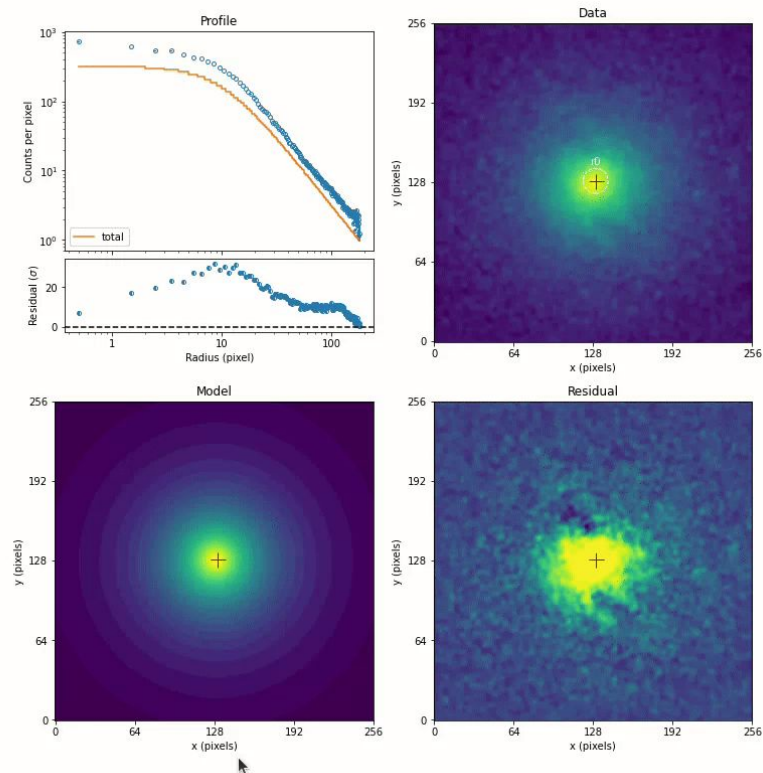

# Narrow-band imaging

---

```
$ flux_obs */*evt.fits outroot=rgb bands=csc bin=1
```

```
$ flux_obs */*evt.fits outroot=myband bands='0.5:1.5:0.9' bin=1
```

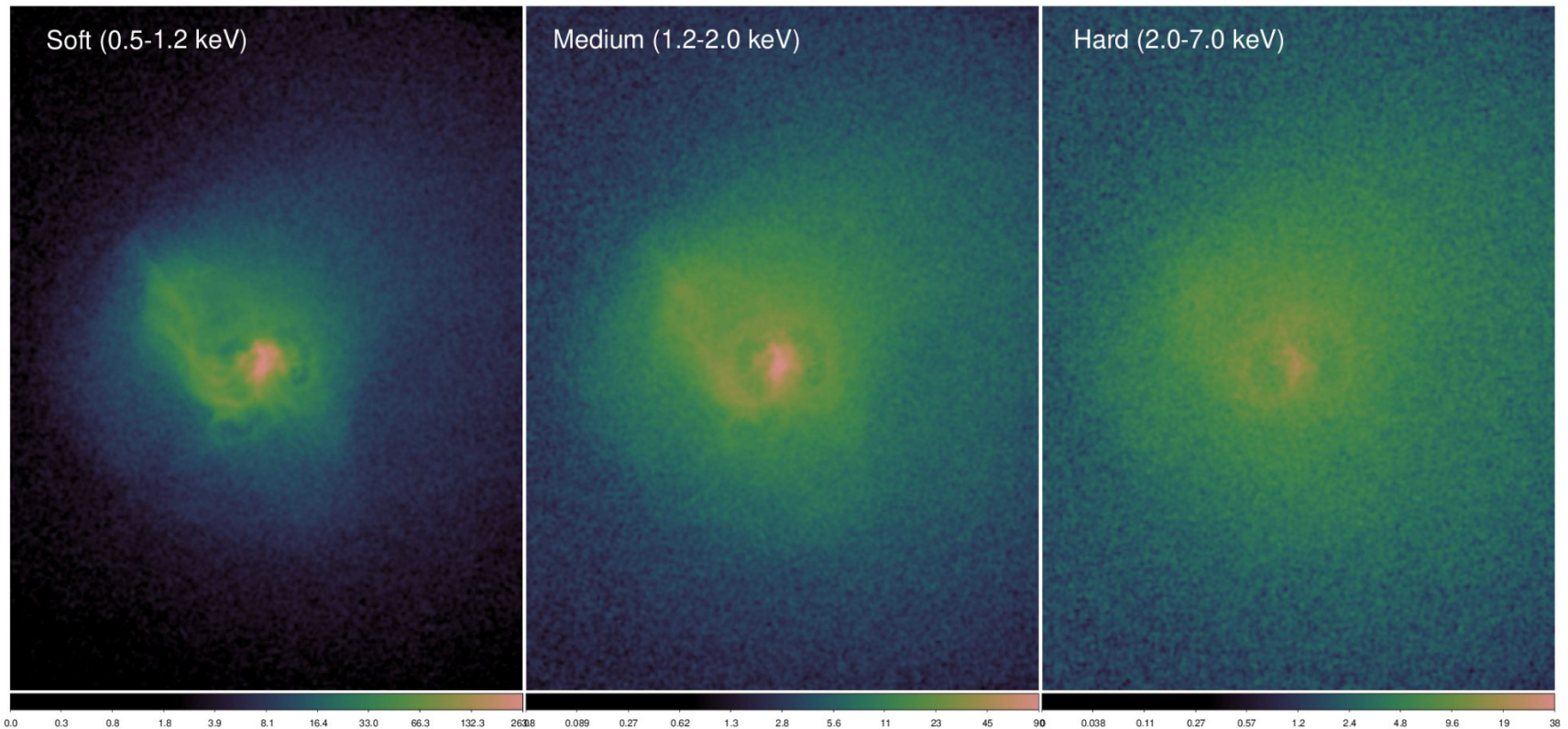

# False-RGB image

---

```
$ ds9 -rgb -red soft.fits -green medium.fits -blue hard.fits -rgb  
lock scale yes -rgb lock colorbar yes -rgb lock smooth yes
```



# Spectral analysis

---

```
$ specextract 'infile[sky=region(file.reg)]' outroot bkgfile  
$ ftgrouppha infile outfile respfile grouptype=min groupscale=1
```

## Produced spectral files (per region per OBSID)

- `spec.pha` - pulse height amplitude, source spectrum
- `spec.pi` - pulse intensity (gain-corrected PHA)
- `spec.grp` - grouped source spectrum
- `spec_bkg.pi` - background spectrum
- `spec.arf` - ancillary response file (ARF)
- `spec.rmfi` - redistribution matrix file (RMF)

```
$ combine_spectra 'src1.pi,src2.pi' outroot
```



# Spectral files (ARF, RMF)

## Ancillary Response File (ARF)

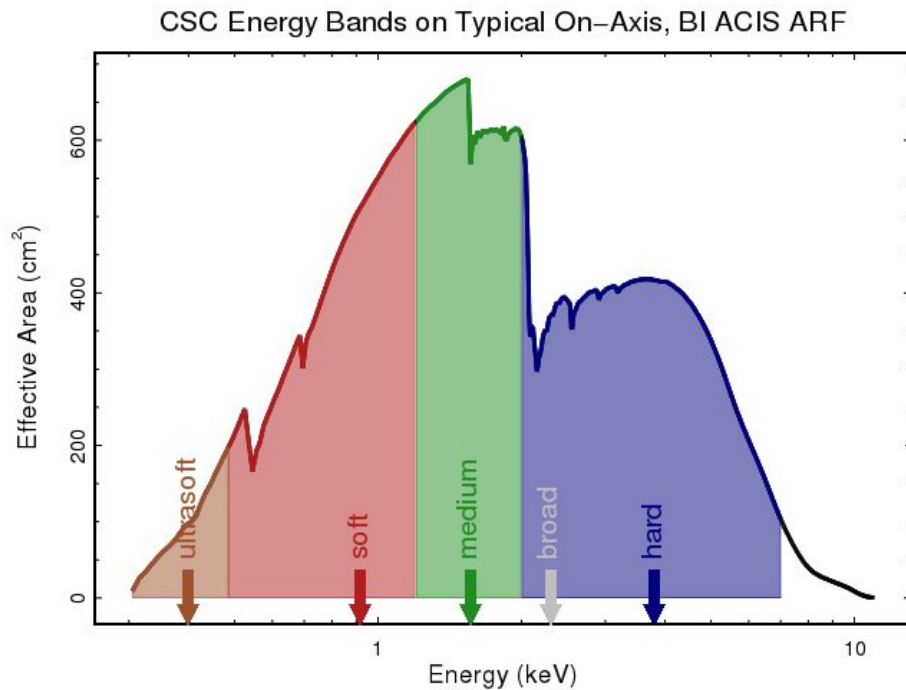

eff. area = geom. area, vignetting, QE

## Redistribution Matrix File (RMF)

### Chandra/ACIS-I3 RMF

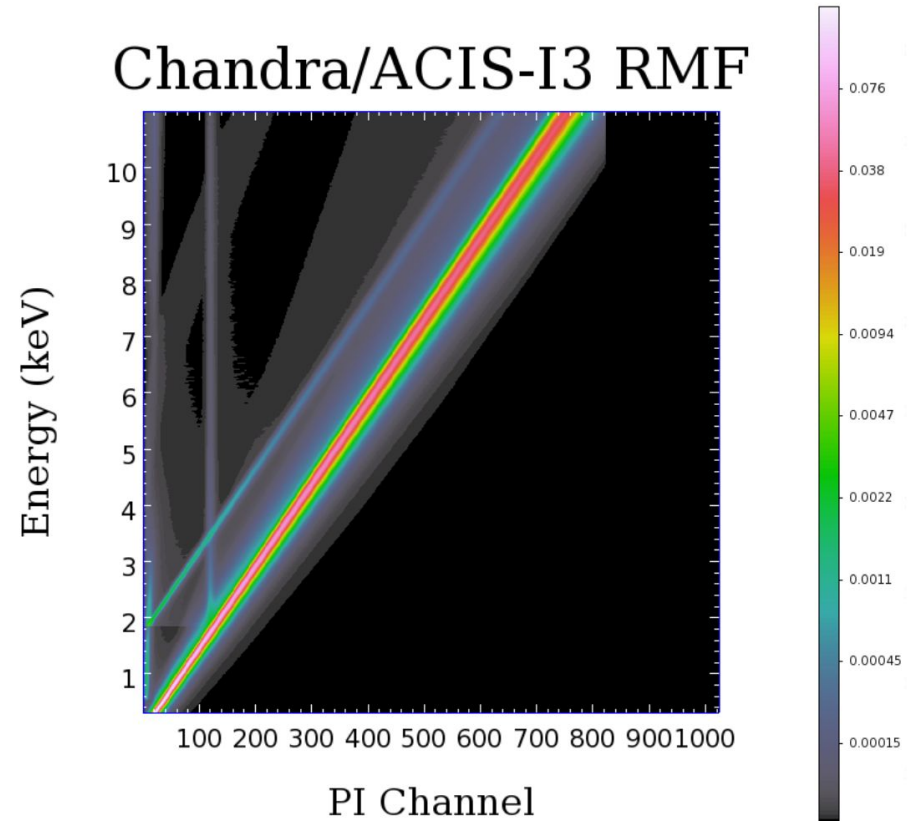

response of detector to  $E_\gamma$

# Fitting X-ray spectra

---

The fitting is performed by **backward modelling** - instead of deconvolving the noisy spectrum with ARF and RMF files (RMF is singular) to obtain the physical spectrum, we fold our physical model through the responses of the telescope (ARF, RMF) and compare to the observed spectrum.

## X-ray fitting software

- [Xspec](#) (AtomDB)
- [Sherpa](#) (xspec-modelonly)
- [SPEX](#) (SPEXACT)

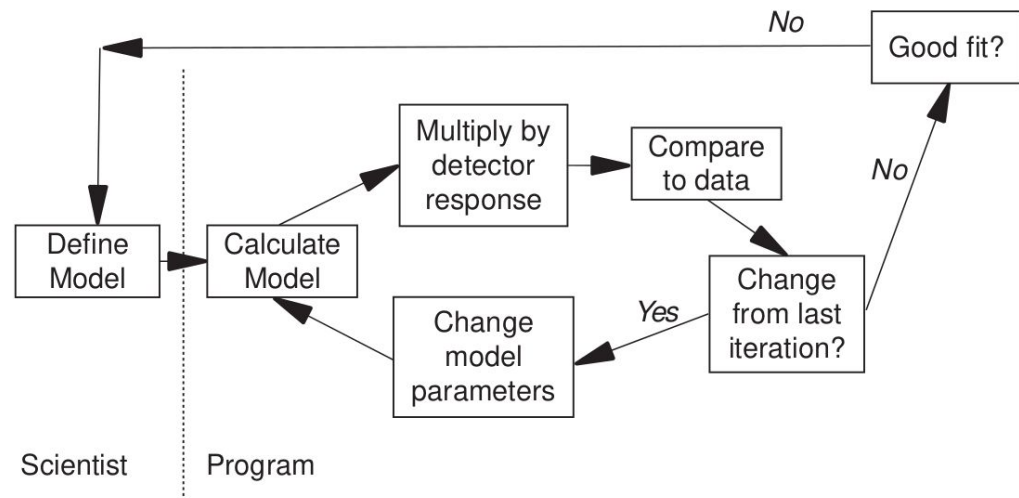

# X-ray sources

## hot galaxy / cluster ICM

phabs (vapec)

temperature  $kT$

electron density  $n_e$

abundance Fe, Mg, Si, S...

## X-ray bright AGN

phabs (powerlaw + gauss)

column density  $nH$

photon index  $\Gamma$

emission lines  $E, \sigma_E, Z$

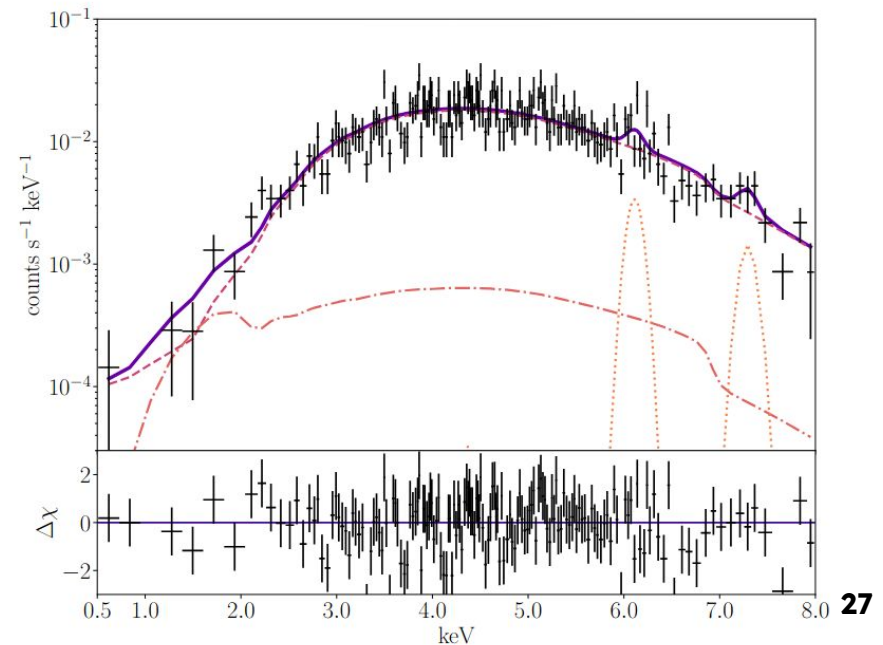
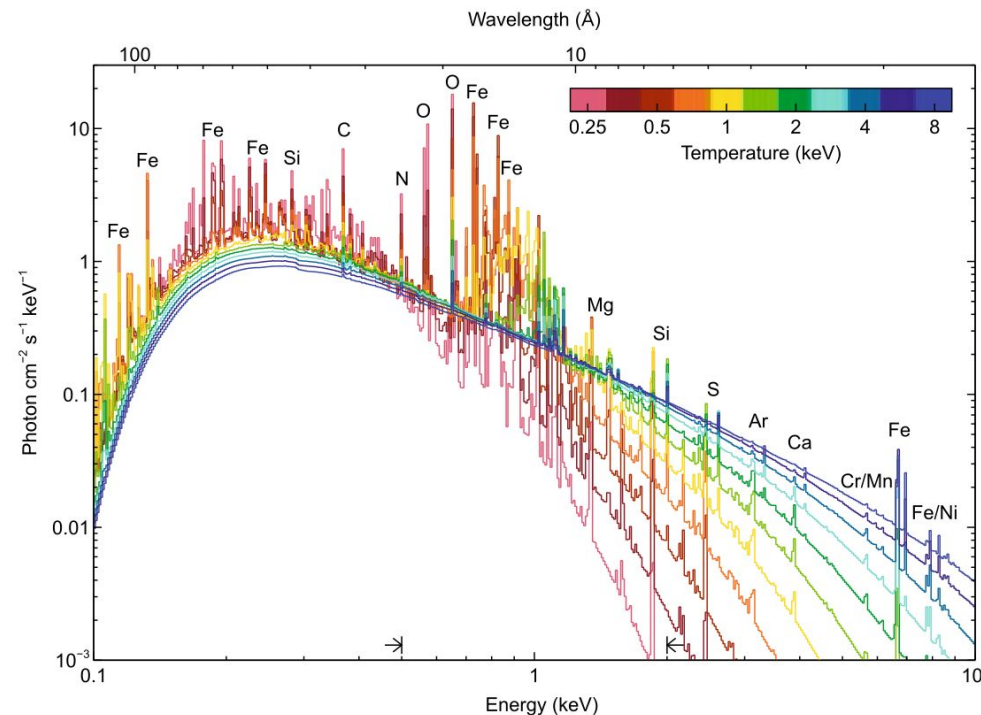

# Backgrounds & Foregrounds

## Sources of absorption

- Galactic absorption - phabs ( $n_{\text{H}}$ )
- intrinsic absorption - zphabs/zwabs ( $n_{\text{H,int}}$ )

## Sources of background / foreground emission

- cosmic X-ray background (CXB) - pow ( $\Gamma = 1.4$ )
- Low-Mass X-ray Binaries (LMXB) - pow ( $\Gamma = 1.56$ )
- North Polar Spur (NPS) - apec ( $kT = 0.25$  keV)
- Galactic halo (GH) - apec ( $kT = 0.2$  keV)
- Local Hot Bubble (LHB) - apec ( $kT = 0.1$  keV)
- instrumental background (background file)

## Instrumental background treatment

- subtraction (chi2, at least 1 count/bin)
- subtraction (cstat)
- modelling (broken powerlaw + lines)

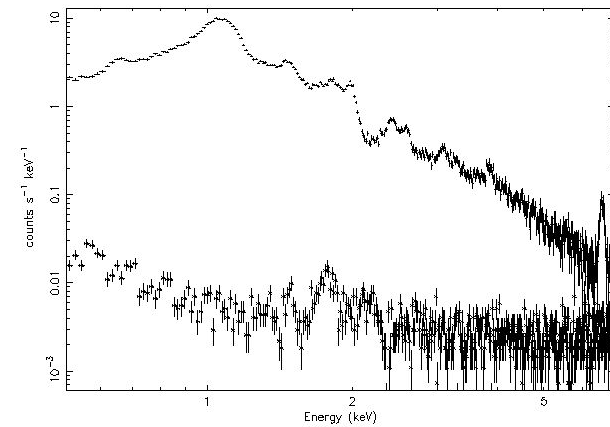
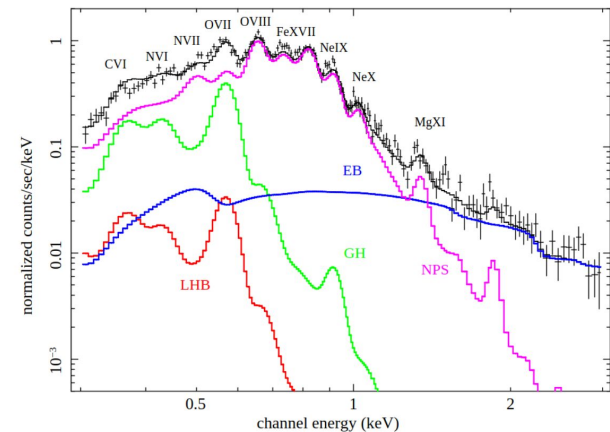
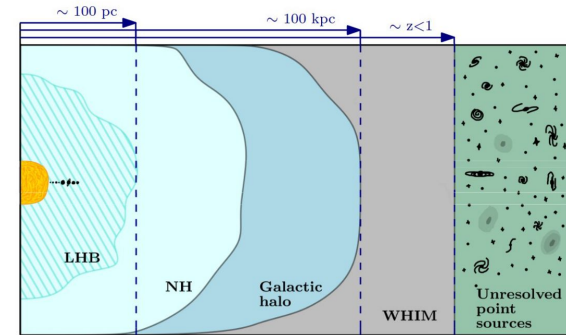

# Spectral deprojection

Projected spectra of extended sources (galaxies or clusters) extracted from thin annuli are “polluted” by spectra from further shells. For systems with temperature gradient (e.g. cool core clusters), projection will not only affect estimates of electron density ( $n_e$ ), but also temperature ( $kT$ ) and abundance ( $Z$ ).

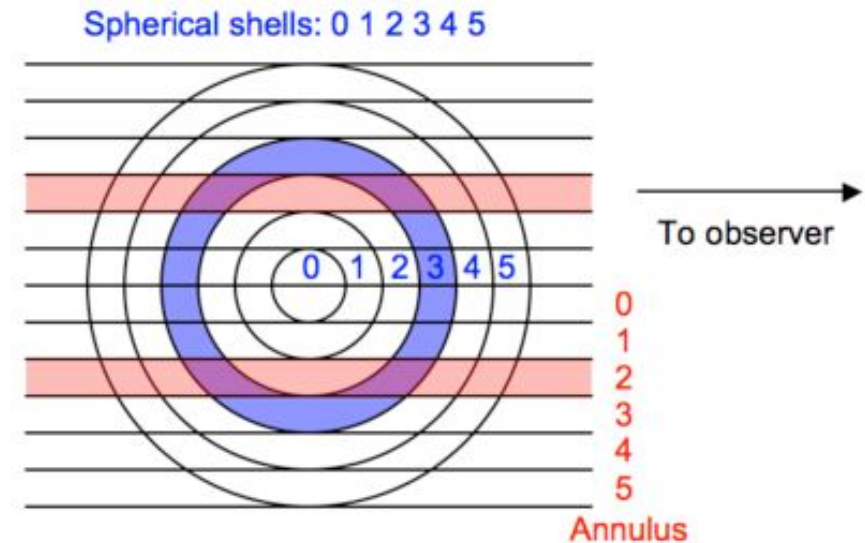
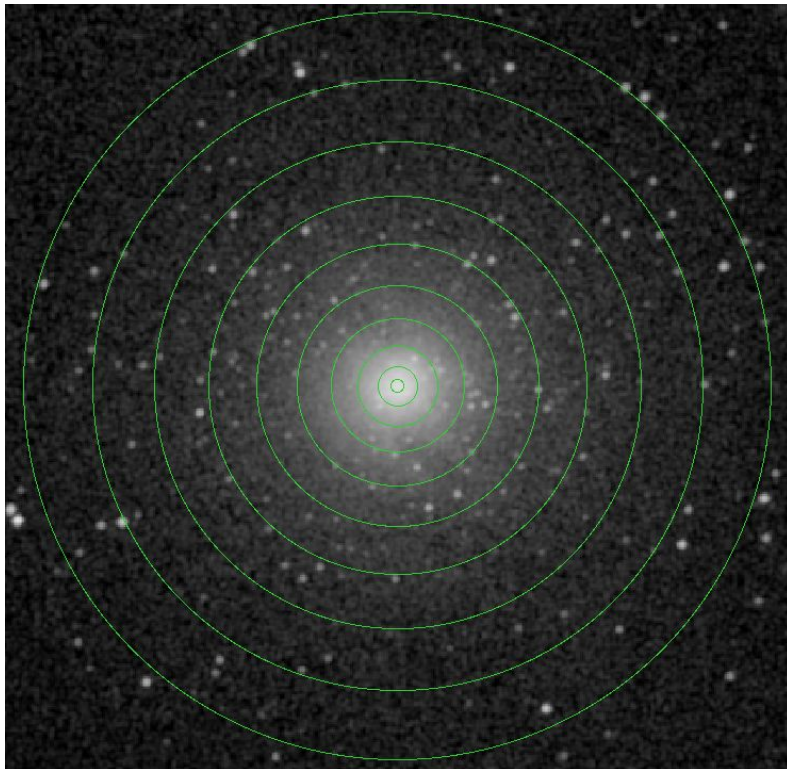

# Spectral deprojection - methods

## Onion peeling

- [project](#) (Xspec)
- [deproject](#) (Sherpa)
- [pyproffit](#)

## Forward modelling

- [cluster](#) (SPEX)

## Direct (non-modelling) method

- [dsdeproj](#) (spectral subtraction)

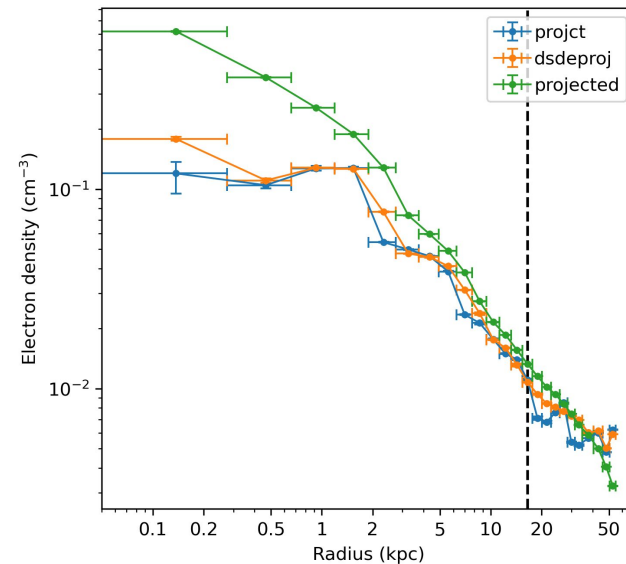
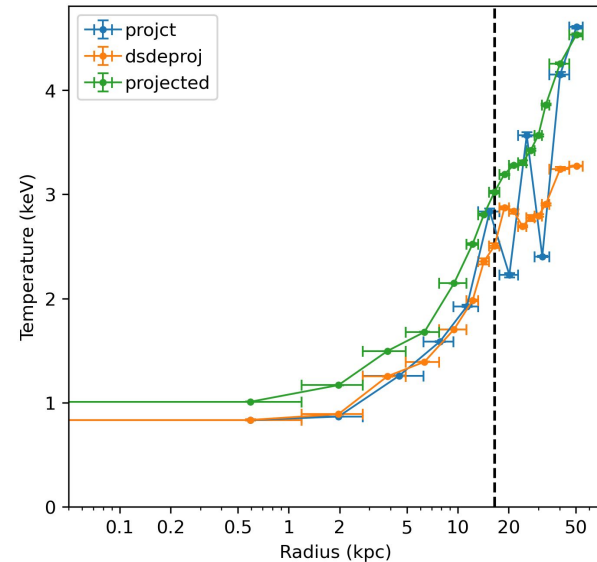

# From raw data to image / spectrum / lightcurve

---

- `download_chandra_obsid` - download specific Chandra OBSID
- `chandra_repro` - produce level 2 products (evt, asol, bpix)
- `reproject` - reproject OBSIDs into one aimpoint
- `flux_obs` - merge OBSIDs (images, expmaps, psfmaps)
- `wavdetect` - detects point sources
- `dmextract` - extract background lightcurve (w/o point sources)
- `deflare` - deflare bg lightcurve → Good Time Intervals (GTI)
- `flux_obs` - merge cleaned OBSIDs
- `fill_sources` - fill point sources in **image** (Poisson)
- `blanksky_files` - produce blanksky/stowed background files
- `specextract` - extract **spectra** from regions of interest
- `dmextract` - extract **lightcurve** for a point source

# Archives & Tools

---

## Data archives

- [ChaSeR](#) - Chandra data archive
- [browse](#) - HEASARC search (UV, X-ray, Gamma)
- [Build Swift-XRT Products](#) - Swift-XRT lightcurve and spectra
- [VLA](#), [VLBI](#), [SAOImageDS9](#) ([DAX](#) - [4ciaodemos](#))

## Databases

- NASA Extragalactic Database [NED](#) (RA, DEC,  $z$ ,  $D$ , SED)
- [HyperLeda](#) (morphology,  $\sigma_v$ , magnitudes, ...)
- Galactic nH ([HEASARC](#), [Swift](#))

## Other tools

- [PIMMS](#)
- [Hiligt](#)



# Example 1: Centaurus cluster (NGC4696)

---

- distance ( $D, z$ )
- galactic column density  $n_{\text{H}}$
- scale pc/”
- velocity dispersion  $\sigma_v \rightarrow M_{\text{SMBH}}, g(<r)$
- AGN position
- X-ray peak
- available observations: images, spectra
- telescopes: Chandra, XMM, VLA

## Example 2: blazar PKS2233-148

---

- redshift  $z$
- Galactic column density  $n_{\text{H}}$
- available observations: spectra, time-series
- telescopes: Swift-XRT, VLBI

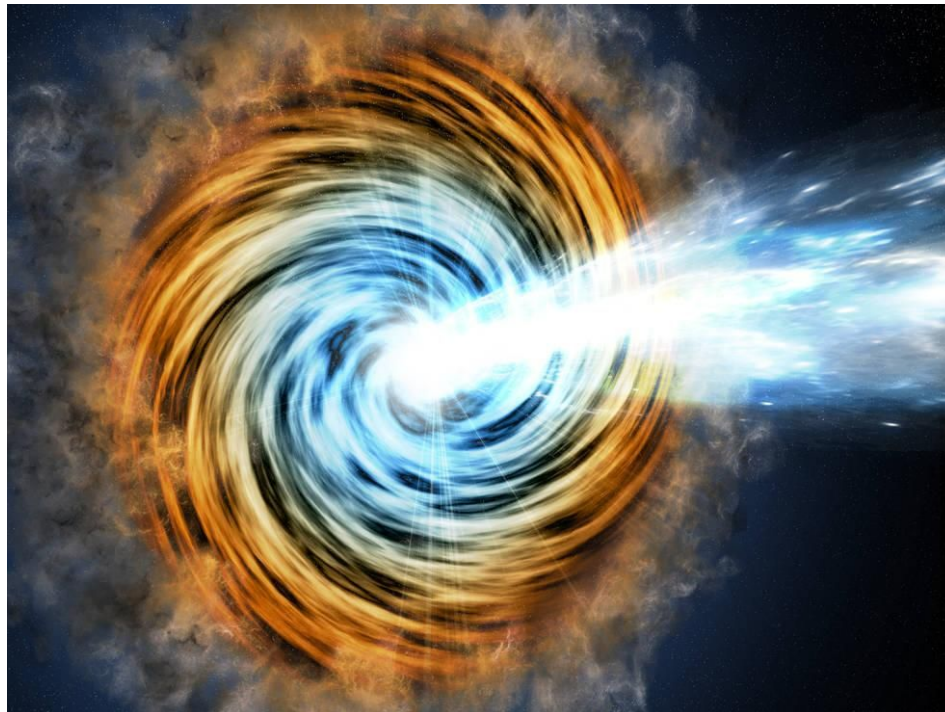

# Bonus: How to SSH

Full tutorial [here](#).

To connect to ssh server, use software (CIAO, Xspec, Sherpa, CASA) or run a Jupyter notebook, follow these steps:

1. Make an account.
2. Connect to the server.
3. Setup shortcut to the server.
4. Setup login without password.
5. Install & use required software.
6. Setup ssh tunnel for Jupyter notebook.

## 1) Make an account.

If we haven't created you an account yet, contact the owner of the server to create you an account. You will need to pick a `username` and a `password`.

## 2) Connect to the server

To try if everything works, you can connect to the server using ssh protocol. For most linux and MAC operating systems, the ssh client should be preinstalled. If not installed, for linux-based systems, installing openssh library should do the job ( `sudo apt install openssh-client` ). For Windows users, I highly recommend switching to UNIX based system :- ) or installing a Windows Subsystem for Linux ([WSL](#)). For pure Windows lovers, the last resort is to use PowerShell or [Putty](#).

After your ssh client is installed, you can connect to the server using the following command:

```
ssh yourusername@servername.com
```